

**LAY-IN HINGED-COVER WIREWAY, NEMA TYPE 1**



**INDUSTRY STANDARDS**

UL 870 Listed; File No. E27524  
 cUL Listed per CSA C22.2 No. 26; File No. E27524

NEMA/EEMAC Type 1  
 IEC 60529, IP30

**APPLICATION**

This wireway provides convenient cable installation and maintenance with its top hinged cover and an opening on one side so wires and cables can be laid in along the entire run without pulling. A variety of lengths and fittings provide increased design flexibility.

**FEATURES**

- Open top assembly
- Removable hinged cover latches with captive screws
- 12.00 x 12.00-in. models available in hinged or non-hinged styles
- Available with or without knockouts on wireway sides
- Covers include captivated plated screw fasteners

**SPECIFICATIONS**

- 16 gauge or 14 gauge steel covers and bodies

**FINISH**

ANSI 61 gray polyester powder paint finish inside and out over pretreated surfaces.

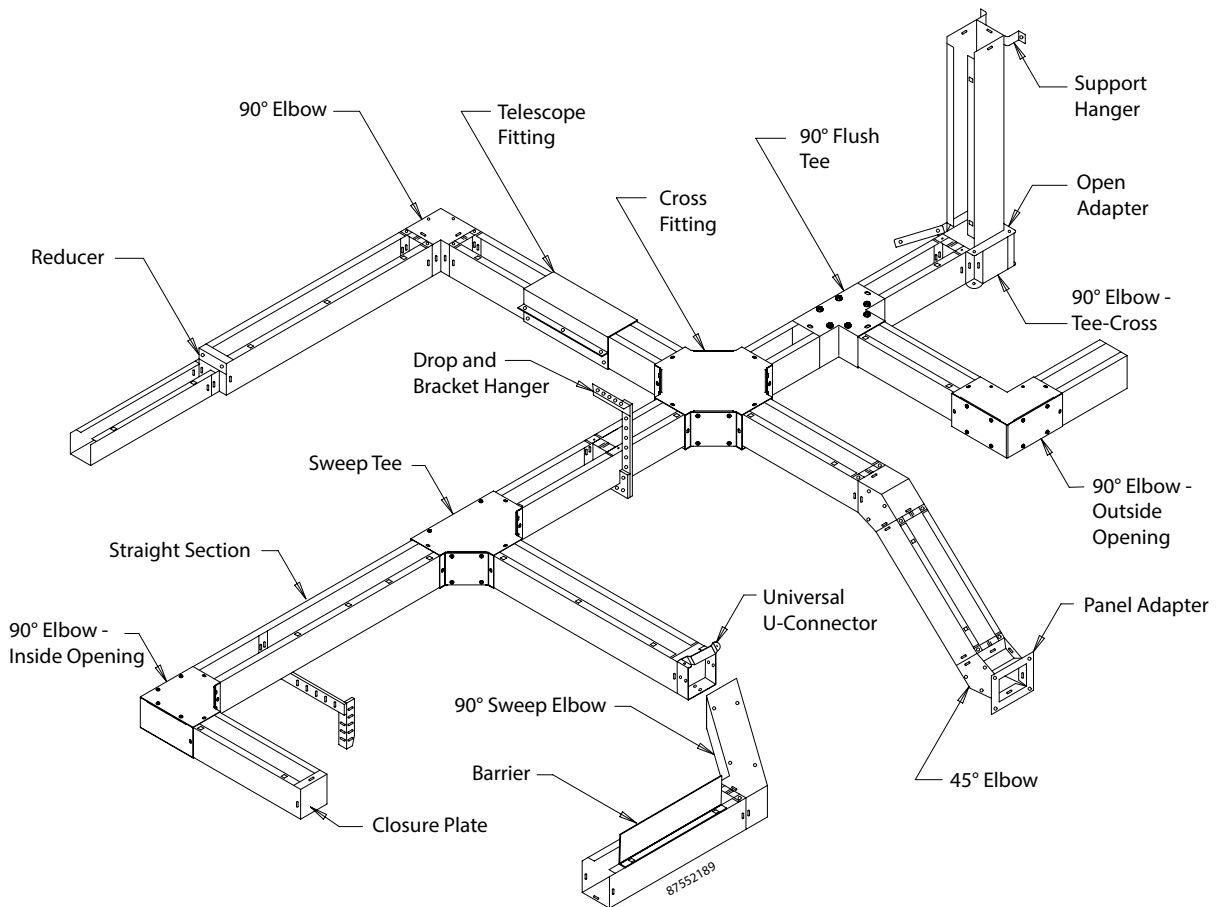

Standard Product Selection Matrix

| Description  | 2.50 x 2.50 in.<br>(64 x 64 mm)<br>16 Gauge | 4.00 x 4.00 in.<br>(102 x 102 mm)<br>16 Gauge | 6.00 x 6.00 in.<br>(152 x 152 mm)<br>16 Gauge | 8.00 x 8.00 in.<br>(203 x 203 mm)<br>14 Gauge | 10.00 x 10.00 in.<br>(254 x 254 mm)<br>14 Gauge | Not Hinged<br>12.00 x 12.00 in.<br>(305 x 305 mm)<br>14 Gauge | Hinged<br>12.00 x 12.00 in.<br>(305 x 305 mm)<br>14 Gauge |
|--|---|---|---|---|---|---|---|
| 12.00-in. (305mm) Straight Section with knockouts      | F22G12WK                                    | F44G12WK                                      | F66G12WK                                      | —   | —   | —   | —   |
| 12.00-in. (305mm) Straight Section without knockouts   | F22G12                                      | F44G12  | F66G12  | F88G12  | F1010G12  | F1212G12  | F1212G12H   |
| 18.00-in. (455mm) Straight Section without knockouts   | —   | F44G18  | F66G18  | F88G18  | —   | —   | —   |
| 24.00-in. (610mm) Straight Section with knockouts      | F22G24WK                                    | F44G24WK                                      | F66G24WK                                      | —   | —   | —   | —   |
| 24.00-in. (610mm) Straight Section without knockouts   | F22G24                                      | F44G24  | F66G24  | F88G24  | F1010G24  | F1212G24  | F1212G24H   |
| 36.00-in. (914mm) Straight Section with knockouts      | F22G36WK                                    | F44G36WK                                      | F66G36WK                                      | —   | —   | —   | —   |
| 36.00-in. (914mm) Straight Section without knockouts   | F22G36                                      | F44G36  | F66G36  | F88G36  | F1010G36  | F1212G36  | F1212G36H   |
| 48.00-in. (1219mm) Straight Section with knockouts     | F22G48WK                                    | F44G48WK                                      | F66G48WK                                      | —   | —   | —   | —   |
| 48.00-in. (1219mm) Straight Section without knockouts  | F22G48                                      | F44G48  | F66G48  | F88G48  | F1010G48  | F1212G48  | F1212G48H   |
| 60.00-in. (1524mm) Straight Section with knockouts     | F22G60WK                                    | F44G60WK                                      | F66G60WK                                      | —   | —   | —   | —   |
| 60.00-in. (1524mm) Straight Section without knockouts  | F22G60                                      | F44G60  | F66G60  | F88G60  | F1010G60  | F1212G60  | F1212G60H   |
| 72.00-in. (1829mm) Straight Section with knockouts     | —   | F44G72WK                                      | F66G72WK                                      | —   | —   | —   | —   |
| 72.00-in. (1829mm) Straight Section without knockouts  | —   | F44G72  | F66G72  | F88G72  | F1010G72  | F1212G72  | F1212G72H   |
| 96.00-in. (2438mm) Straight Section with knockouts     | —   | F44G96  | F66G96  | F88G96  | F1010G96  | F1212G96  | —   |
| 120.00-in. (3048mm) Straight Section with knockouts    | F22G120WK                                   | F44G120WK                                     | F66G120WK                                     | —   | —   | —   | —   |
| 120.00-in. (3048mm) Straight Section without knockouts | F22G120                                     | F44G120                                       | F66G120                                       | F88G120                                       | F1010G120                                       | F1212G120   | F1212G120H  |
| 90° Flush Tee  | F22GT                                       | F44GT   | F66GT   | F88GT   | F1010GT   | F1212GT   | F1212GT   |
| Sweep Tee  | F22T  | F44T  | F66T  | F88T  | F1010T  | F1212T  | F1212T  |
| Cross Fitting  | F22X  | F44X  | F66X  | F88X  | F1010X  | F1212X  | F1212X  |
| 90° Sweep Elbow  | F22G90SE                                    | F44G90SE                                      | F66G90SE                                      | F88G90SE                                      | F1010G90SE                                      | F1212G90SE  | F1212G90SE  |
| 90° Elbow-Tee-Cross                                    | F22G90TX                                    | F44G90TX                                      | F66G90TX                                      | F88G90TX                                      | F1010G90TX                                      | F1212G90TX  | F1212G90TX  |
| 90° Elbow  | F22G90E                                     | F44G90E                                       | F66G90E                                       | F88G90E                                       | F1010G90E                                       | F1212G90E   | F1212G90E   |
| 90° Elbow Outside Opening                              | F2290EOUT                                   | F4490EOUT                                     | F6690EOUT                                     | F8890EOUT                                     | F101090EOUT                                     | F121290EOUT   | F121290EOUT   |
| 90° Elbow Inside Opening                               | F2290EIN                                    | F4490EIN                                      | F6690EIN                                      | F8890EIN                                      | F101090EIN                                      | F121290EIN  | F121290EIN  |
| 45° Elbow  | F22G45E                                     | F44G45E                                       | F66G45E                                       | F88G45E                                       | F1010G45E                                       | F1212G45E   | F1212G45E   |
| Telescope Fitting <sup>a</sup>                         | F22GA                                       | F44GA   | F66GA   | F88GA   | F1010GA   | F1212GA   | F1212GA   |
| Open Adapter   | F22GOA                                      | F44GOA  | F66GOA  | F88GOA  | F1010GOA  | F1212GOA  | F1212GOA  |
| Panel Adapter  | F22GPA                                      | F44GPA  | F66GPA  | F88GPA  | F1010GPA  | F1212GPA  | F1212GPA  |
| Closure Plate without knockouts                        | F22GCPNK                                    | F44GCPNK                                      | F66GCPNK                                      | F88GCPNK                                      | F1010GCPNK                                      | F1212GCPNK  | F1212GCPNK  |
| Closure Plate with knockouts                           | F22GCP                                      | F44GCP  | F66GCP  | F88GCP  | F1010GCP  | F1212GCP  | F1212GCP  |
| Reducer  | —   | F44G22R                                       | F66G44R                                       | F88G66R                                       | F1010G88R                                       | F1212G88R<br>F1212G1010R                                      | F1212G88R<br>F1212G1010R                                  |
| Drop and Bracket Hanger                                | F22GDB                                      | F44GDB  | F66GDB  | F88GDB  | F1010GDB  | F1212GDB  | F1212GDB  |
| Support Hanger   | F22GSH                                      | F44GSH  | F66GSH  | F88GSH  | F1010GSH  | F1212GSH  | F1212GSH  |
| Universal U-Connector                                  | F22GUC                                      | F44GUC  | F66GUC  | F88GUC  | F1010GUC  | F1212GUC  | F1212GUC  |
| Barrier Kit, bolt-on<br>h barrier 60.00 in. (1524 mm)  | —   | F44BK60                                       | F66BK60                                       | F88BK60                                       | —   | —   | —   |

<sup>a</sup>Not UL/cUL listed.

STRAIGHT SECTION

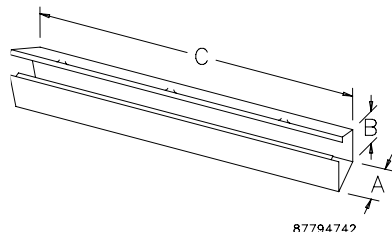

Available in lengths from 12.00 in. (305 mm), with or without knockouts.

BULLETIN: F40, F40PF

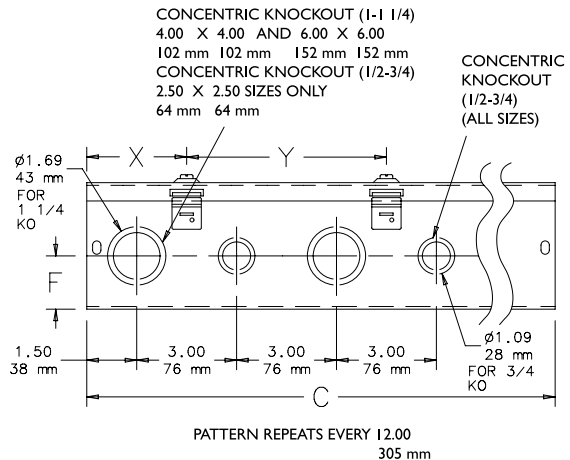

Patented hidden hinge permits usual plated steel screw cover arrangement to be converted to hinge cover system on all sizes except 12.00 in x 12.00 in. (305mm x 305mm).

**Straight Sections**

| Catalog Number | AxBxC in.              | AxBxC mm         | Number of Knockouts,<br>.50 in.-.75 in. | Number of Knockouts,<br>1.00 in.-1.25 in. | F (in.) | F (mm) | X (in.) | X (mm) | Y (in.) | Y (mm) |
|----------------|------------------------|------------------|---|---|---------|--------|---------|--------|---------|--------|
| F22G12WK       | 2.50 x 2.50 x 12.00    | 64 x 64 x 305    | 8                                       | —   | 1.06    | 27     | 3.00    | 76     | 6.00    | 152    |
| F22G12         | 2.50 x 2.50 x 12.00    | 64 x 64 x 305    | —                                       | —   | —       | —      | —       | —      | —       | —      |
| F22G24WK       | 2.50 x 2.50 x 24.00    | 64 x 64 x 610    | 16                                      | —   | 1.06    | 27     | 6.00    | 152    | 12.00   | 305    |
| F22G24         | 2.50 x 2.50 x 24.00    | 64 x 64 x 610    | —                                       | —   | —       | —      | —       | —      | —       | —      |
| F22G36WK       | 2.50 x 2.50 x 36.00    | 64 x 64 x 914    | 24                                      | —   | 1.06    | 27     | 6.00    | 152    | 12.00   | 305    |
| F22G36         | 2.50 x 2.50 x 36.00    | 64 x 64 x 914    | —                                       | —   | —       | —      | —       | —      | —       | —      |
| F22G48WK       | 2.50 x 2.50 x 48.00    | 64 x 64 x 1219   | 32                                      | —   | 1.06    | 27     | 6.00    | 152    | 12.00   | 305    |
| F22G48         | 2.50 x 2.50 x 48.00    | 64 x 64 x 1219   | —                                       | —   | —       | —      | —       | —      | —       | —      |
| F22G60WK       | 2.50 x 2.50 x 60.00    | 64 x 64 x 1524   | 40                                      | —   | 1.06    | 27     | 6.00    | 152    | 12.00   | 305    |
| F22G60         | 2.50 x 2.50 x 60.00    | 64 x 64 x 1524   | —                                       | —   | —       | —      | —       | —      | —       | —      |
| F22G120WK      | 2.50 x 2.50 x 120.00   | 64 x 64 x 3048   | 80                                      | —   | 1.06    | 27     | 6.00    | 152    | 12.00   | 305    |
| F22G120        | 2.50 x 2.50 x 120.00   | 64 x 64 x 3048   | —                                       | —   | —       | —      | —       | —      | —       | —      |
| F44G12WK       | 4.00 x 4.00 x 12.00    | 102 x 102 x 305  | 4                                       | 4   | 1.62    | 41     | 3.00    | 76     | 6.00    | 152    |
| F44G12         | 4.00 x 4.00 x 12.00    | 102 x 102 x 305  | —                                       | —   | —       | —      | —       | —      | —       | —      |
| F44G18         | 4.00 x 4.00 x 18.00    | 102 x 102 x 457  | —                                       | —   | —       | —      | —       | —      | —       | —      |
| F44G24WK       | 4.00 x 4.00 x 24.00    | 102 x 102 x 610  | 8                                       | 8   | 1.62    | 41     | 6.00    | 152    | 12.00   | 305    |
| F44G24         | 4.00 x 4.00 x 24.00    | 102 x 102 x 610  | —                                       | —   | —       | —      | —       | —      | —       | —      |
| F44G36WK       | 4.00 x 4.00 x 36.00    | 102 x 102 x 914  | 12                                      | 12  | 1.62    | 41     | 6.00    | 152    | 12.00   | 305    |
| F44G36         | 4.00 x 4.00 x 36.00    | 102 x 102 x 914  | —                                       | —   | —       | —      | —       | —      | —       | —      |
| F44G48WK       | 4.00 x 4.00 x 48.00    | 102 x 102 x 1219 | 16                                      | 16  | 1.62    | 41     | 6.00    | 152    | 12.00   | 305    |
| F44G48         | 4.00 x 4.00 x 48.00    | 102 x 102 x 1219 | —                                       | —   | —       | —      | —       | —      | —       | —      |
| F44G60WK       | 4.00 x 4.00 x 60.00    | 102 x 102 x 1524 | 20                                      | 20  | 1.62    | 41     | 6.00    | 152    | 12.00   | 305    |
| F44G60         | 4.00 x 4.00 x 60.00    | 102 x 102 x 1524 | —                                       | —   | —       | —      | —       | —      | —       | —      |
| F44G72WK       | 4.00 x 4.00 x 72.00    | 102 x 102 x 1829 | 24                                      | 24  | 1.62    | 41     | 6.00    | 152    | 12.00   | 305    |
| F44G72         | 4.00 x 4.00 x 72.00    | 102 x 102 x 1829 | —                                       | —   | —       | —      | —       | —      | —       | —      |
| F44G96         | 4.00 x 4.00 x 96.00    | 102 x 102 x 2438 | —                                       | —   | —       | —      | —       | —      | —       | —      |
| F44G120WK      | 4.00 x 4.00 x 120.00   | 102 x 102 x 3048 | 40                                      | 40  | 1.62    | 41     | 6.00    | 152    | 12.00   | 305    |
| F44G120        | 4.00 x 4.00 x 120.00   | 102 x 102 x 3048 | —                                       | —   | —       | —      | —       | —      | —       | —      |
| F66G12WK       | 6.00 x 6.00 x 12.00    | 152 x 152 x 305  | 4                                       | 4   | 1.62    | 41     | 3.00    | 76     | 6.00    | 152    |
| F66G12         | 6.00 x 6.00 x 12.00    | 152 x 152 x 305  | —                                       | —   | —       | —      | —       | —      | —       | —      |
| F66G18         | 6.00 x 6.00 x 18.00    | 152 x 152 x 457  | —                                       | —   | —       | —      | —       | —      | —       | —      |
| F66G24WK       | 6.00 x 6.00 x 24.00    | 152 x 152 x 610  | 8                                       | 8   | 1.62    | 41     | 6.00    | 152    | 12.00   | 305    |
| F66G24         | 6.00 x 6.00 x 24.00    | 152 x 152 x 610  | —                                       | —   | —       | —      | —       | —      | —       | —      |
| F66G36WK       | 6.00 x 6.00 x 36.00    | 152 x 152 x 914  | 12                                      | 12  | 1.62    | 41     | 6.00    | 152    | 12.00   | 305    |
| F66G36         | 6.00 x 6.00 x 36.00    | 152 x 152 x 914  | —                                       | —   | —       | —      | —       | —      | —       | —      |
| F66G48WK       | 6.00 x 6.00 x 48.00    | 152 x 152 x 1219 | 16                                      | 16  | 1.62    | 41     | 6.00    | 152    | 12.00   | 305    |
| F66G48         | 6.00 x 6.00 x 48.00    | 152 x 152 x 1219 | —                                       | —   | —       | —      | —       | —      | —       | —      |
| F66G60WK       | 6.00 x 6.00 x 60.00    | 152 x 152 x 1524 | 20                                      | 20  | 1.62    | 41     | 6.00    | 152    | 12.00   | 305    |
| F66G60         | 6.00 x 6.00 x 60.00    | 152 x 152 x 1524 | —                                       | —   | —       | —      | —       | —      | —       | —      |
| F66G72WK       | 6.00 x 6.00 x 72.00    | 152 x 152 x 1829 | 24                                      | 24  | 1.62    | 41     | 6.00    | 152    | 12.00   | 305    |
| F66G72         | 6.00 x 6.00 x 72.00    | 152 x 152 x 1829 | —                                       | —   | —       | —      | —       | —      | —       | —      |
| F66G96         | 6.00 x 6.00 x 96.00    | 152 x 152 x 2438 | —                                       | —   | —       | —      | —       | —      | —       | —      |
| F66G120WK      | 6.00 x 6.00 x 120.00   | 152 x 152 x 3048 | 40                                      | 40  | 1.62    | 41     | 6.00    | 152    | 12.00   | 305    |
| F66G120        | 6.00 x 6.00 x 120.00   | 152 x 152 x 3048 | —                                       | —   | —       | —      | —       | —      | —       | —      |
| F88G12         | 8.00 x 8.00 x 12.00    | 203 x 203 x 305  | —                                       | —   | —       | —      | —       | —      | —       | —      |
| F88G18         | 8.00 x 8.00 x 18.00    | 203 x 203 x 457  | —                                       | —   | —       | —      | —       | —      | —       | —      |
| F88G24         | 8.00 x 8.00 x 24.00    | 203 x 203 x 610  | —                                       | —   | —       | —      | —       | —      | —       | —      |
| F88G36         | 8.00 x 8.00 x 36.00    | 203 x 203 x 914  | —                                       | —   | —       | —      | —       | —      | —       | —      |
| F88G48         | 8.00 x 8.00 x 48.00    | 203 x 203 x 1219 | —                                       | —   | —       | —      | —       | —      | —       | —      |
| F88G60         | 8.00 x 8.00 x 60.00    | 203 x 203 x 1524 | —                                       | —   | —       | —      | —       | —      | —       | —      |
| F88G72         | 8.00 x 8.00 x 72.00    | 203 x 203 x 1829 | —                                       | —   | —       | —      | —       | —      | —       | —      |
| F88G96         | 8.00 x 8.00 x 96.00    | 203 x 203 x 2438 | —                                       | —   | —       | —      | —       | —      | —       | —      |
| F88G120        | 8.00 x 8.00 x 120.00   | 203 x 203 x 3048 | —                                       | —   | —       | —      | —       | —      | —       | —      |
| F1010G12       | 10.00 x 10.00 x 12.00  | 254 x 254 x 305  | —                                       | —   | —       | —      | —       | —      | —       | —      |
| F1010G24       | 10.00 x 10.00 x 24.00  | 254 x 254 x 610  | —                                       | —   | —       | —      | —       | —      | —       | —      |
| F1010G36       | 10.00 x 10.00 x 36.00  | 254 x 254 x 914  | —                                       | —   | —       | —      | —       | —      | —       | —      |
| F1010G48       | 10.00 x 10.00 x 48.00  | 254 x 254 x 1219 | —                                       | —   | —       | —      | —       | —      | —       | —      |
| F1010G60       | 10.00 x 10.00 x 60.00  | 254 x 254 x 1524 | —                                       | —   | —       | —      | —       | —      | —       | —      |
| F1010G72       | 10.00 x 10.00 x 72.00  | 254 x 254 x 1829 | —                                       | —   | —       | —      | —       | —      | —       | —      |
| F1010G96       | 10.00 x 10.00 x 96.00  | 254 x 254 x 2438 | —                                       | —   | —       | —      | —       | —      | —       | —      |
| F1010G120      | 10.00 x 10.00 x 120.00 | 254 x 254 x 3048 | —                                       | —   | —       | —      | —       | —      | —       | —      |
| F1212G12       | 12.00 x 12.00 x 12.00  | 305 x 305 x 305  | —                                       | —   | —       | —      | —       | —      | —       | —      |
| F1212G12H      | 12.00 x 12.00 x 12.00  | 305 x 305 x 305  | —                                       | —   | —       | —      | —       | —      | —       | —      |
| F1212G24       | 12.00 x 12.00 x 24.00  | 305 x 305 x 610  | —                                       | —   | —       | —      | —       | —      | —       | —      |
| F1212G24H      | 12.00 x 12.00 x 24.00  | 305 x 305 x 610  | —                                       | —   | —       | —      | —       | —      | —       | —      |
| F1212G36       | 12.00 x 12.00 x 36.00  | 305 x 305 x 914  | —                                       | —   | —       | —      | —       | —      | —       | —      |
| F1212G36H      | 12.00 x 12.00 x 36.00  | 305 x 305 x 914  | —                                       | —   | —       | —      | —       | —      | —       | —      |
| F1212G48       | 12.00 x 12.00 x 48.00  | 305 x 305 x 1219 | —                                       | —   | —       | —      | —       | —      | —       | —      |
| F1212G48H      | 12.00 x 12.00 x 48.00  | 305 x 305 x 1219 | —                                       | —   | —       | —      | —       | —      | —       | —      |
| F1212G60       | 12.00 x 12.00 x 60.00  | 305 x 305 x 1524 | —                                       | —   | —       | —      | —       | —      | —       | —      |
| F1212G60H      | 12.00 x 12.00 x 60.00  | 305 x 305 x 1524 | —                                       | —   | —       | —      | —       | —      | —       | —      |
| F1212G72       | 12.00 x 12.00 x 72.00  | 305 x 305 x 1829 | —                                       | —   | —       | —      | —       | —      | —       | —      |
| F1212G72H      | 12.00 x 12.00 x 72.00  | 305 x 305 x 1829 | —                                       | —   | —       | —      | —       | —      | —       | —      |
| F1212G96       | 12.00 x 12.00 x 96.00  | 305 x 305 x 2438 | —                                       | —   | —       | —      | —       | —      | —       | —      |
| F1212G120      | 12.00 x 12.00 x 120.00 | 305 x 305 x 3048 | —                                       | —   | —       | —      | —       | —      | —       | —      |
| F1212G120H     | 12.00 x 12.00 x 120.00 | 305 x 305 x 3048 | —                                       | —   | —       | —      | —       | —      | —       | —      |

F1212GXX catalog numbers without "H" are not hinged. F1212GXXH catalog numbers are hinged.

### 90-DEGREE FLUSH TEE

For flush mounting against a vertical or horizontal surface.

BULLETIN: F40PF

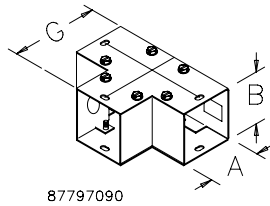

| Catalog Number | AxB in./mm                 | G in./mm     |
|----------------|----------------------------|--------------|
| F22GT          | 2.50 x 2.50<br>64 x 64     | 4.50<br>114  |
| F33GT          | 3.00 x 3.00<br>76 x 76     | 5.00<br>127  |
| F44GT          | 4.00 x 4.00<br>102 x 102   | 6.00<br>152  |
| F66GT          | 6.00 x 6.00<br>152 x 152   | 8.00<br>203  |
| F88GT          | 8.00 x 8.00<br>203 x 203   | 10.00<br>254 |
| F1010GT        | 10.00 x 10.00<br>254 x 254 | 12.00<br>305 |
| F1212GT        | 12.00 x 12.00<br>305 x 305 | 14.00<br>356 |

### SWEEP TEE

For large radius turns. Mounts against vertical or horizontal surfaces. Top and inside covers removable.

BULLETIN: F40PF

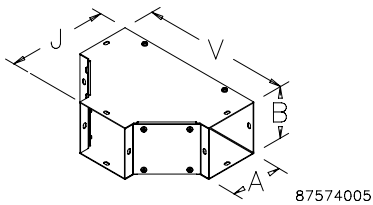

| Catalog Number | AxB in./mm                 | J in./mm     | V in./mm     |
|----------------|----------------------------|--------------|--------------|
| F22T           | 2.50 x 2.50<br>64 x 64     | 6.50<br>165  | 10.35<br>263 |
| F44T           | 4.00 x 4.00<br>102 x 102   | 8.00<br>203  | 11.85<br>301 |
| F66T           | 6.00 x 6.00<br>152 x 152   | 10.00<br>254 | 13.85<br>352 |
| F88T           | 8.00 x 8.00<br>203 x 203   | 12.00<br>305 | 15.84<br>402 |
| F1010T         | 10.00 x 10.00<br>254 x 254 | 14.00<br>356 | 17.84<br>453 |
| F1212T         | 12.00 x 12.00<br>305 x 305 | 16.00<br>406 | 19.84<br>504 |

### CROSS FITTING

For routing cables in four directions. Top, bottom and side covers removable.

BULLETIN: F40PF

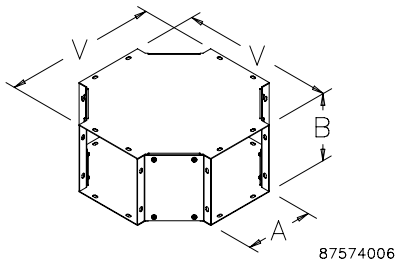

| Catalog Number | AxB in./mm                 | V in./mm     |
|----------------|----------------------------|--------------|
| F22X           | 2.50 x 2.50<br>64 x 64     | 10.35<br>263 |
| F44X           | 4.00 x 4.00<br>102 x 102   | 11.85<br>301 |
| F66X           | 6.00 x 6.00<br>152 x 152   | 13.85<br>352 |
| F88X           | 8.00 x 8.00<br>203 x 203   | 15.84<br>402 |
| F1010X         | 10.00 x 10.00<br>254 x 254 | 17.84<br>453 |
| F1212X         | 12.00 x 12.00<br>305 x 305 | 19.84<br>504 |

### 90-DEGREE SWEEP ELBOW

For large radius turns.

BULLETIN: F40PF

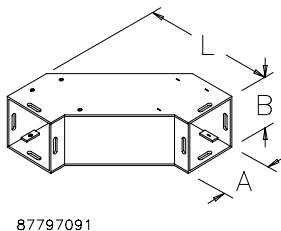

| Catalog Number | AxB in./mm                 | L in./mm     |
|----------------|----------------------------|--------------|
| F22G90SE       | 2.50 x 2.50<br>64 x 64     | 7.91<br>201  |
| F44G90SE       | 4.00 x 4.00<br>102 x 102   | 9.41<br>239  |
| F66G90SE       | 6.00 x 6.00<br>152 x 152   | 11.34<br>288 |
| F88G90SE       | 8.00 x 8.00<br>203 x 203   | 13.44<br>341 |
| F1010G90SE     | 10.00 x 10.00<br>254 x 254 | 15.62<br>395 |
| F1212G90SE     | 12.00 x 12.00<br>305 x 305 | 17.44<br>443 |

### 90-DEGREE ELBOW-TEE-CROSS

Forms left or right 90-degree turns. Can be used as a tee or cross. Use with open adapter for cable entrance in top and bottom. Includes two closure plates.

**BULLETIN: F40PF**

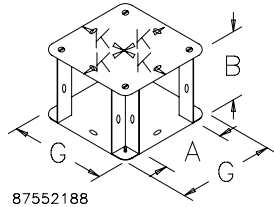

87552188

### 90-DEGREE ELBOW

Any side can be removed, retaining lay-in feature regardless of how the elbow is oriented. Sides are held together with screws.

**BULLETIN: F40PF**

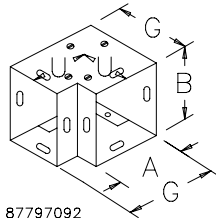

87797092

### 90-DEGREE ELBOW—OUTSIDE OPENING

For continuous run with 90-degree turns. Top, bottom and outside covers removable.

**BULLETIN: F40PF**

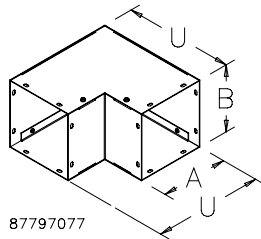

87797077

### 90-DEGREE ELBOW—INSIDE OPENING

For continuous run with 90-degree turns. Top and inside covers removable.

**BULLETIN: F40PF**

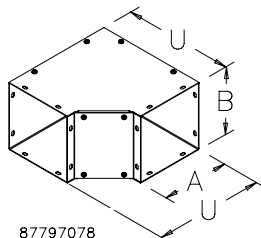

87797078

| Catalog Number | AxB in./mm                 | G in./mm     | K in./mm    |
|----------------|----------------------------|--------------|-------------|
| F22G90TX       | 2.50 x 2.50<br>64 x 64     | 4.50<br>114  | 2.25<br>57  |
| F33G90TX       | 3.00 x 3.00<br>76 x 76     | 5.00<br>127  | 2.50<br>64  |
| F44G90TX       | 4.00 x 4.00<br>102 x 102   | 6.00<br>152  | 3.00<br>76  |
| F66G90TX       | 6.00 x 6.00<br>152 x 152   | 8.00<br>203  | 4.00<br>102 |
| F88G90TX       | 8.00 x 8.00<br>203 x 203   | 10.00<br>254 | 5.00<br>127 |
| F1010G90TX     | 10.00 x 10.00<br>254 x 254 | 12.00<br>305 | 6.00<br>152 |
| F1212G90TX     | 12.00 x 12.00<br>305 x 305 | 14.00<br>356 | 7.00<br>178 |

| Catalog Number | AxB in./mm                 | G in./mm     |
|----------------|----------------------------|--------------|
| F22G90E        | 2.50 x 2.50<br>64 x 64     | 4.50<br>114  |
| F33G90E        | 3.00 x 3.00<br>76 x 76     | 5.00<br>127  |
| F44G90E        | 4.00 x 4.00<br>102 x 102   | 6.00<br>152  |
| F66G90E        | 6.00 x 6.00<br>152 x 152   | 8.00<br>203  |
| F88G90E        | 8.00 x 8.00<br>203 x 203   | 10.00<br>254 |
| F1010G90E      | 10.00 x 10.00<br>254 x 254 | 12.00<br>305 |
| F1212G90E      | 12.00 x 12.00<br>305 x 305 | 14.00<br>356 |

| Catalog Number | AxB in./mm                 | U in./mm     |
|----------------|----------------------------|--------------|
| F2290EOUT      | 2.50 x 2.50<br>64 x 64     | 6.50<br>165  |
| F4490EOUT      | 4.00 x 4.00<br>102 x 102   | 8.00<br>203  |
| F6690EOUT      | 6.00 x 6.00<br>152 x 152   | 10.00<br>254 |
| F8890EOUT      | 8.00 x 8.00<br>203 x 203   | 12.00<br>305 |
| F101090EOUT    | 10.00 x 10.00<br>254 x 254 | 14.00<br>356 |
| F121290EOUT    | 12.00 x 12.00<br>305 x 305 | 16.00<br>406 |

| Catalog Number | AxB in./mm                 | U in./mm     |
|----------------|----------------------------|--------------|
| F2290EIN       | 2.50 x 2.50<br>64 x 64     | 6.50<br>165  |
| F4490EIN       | 4.00 x 4.00<br>102 x 102   | 8.00<br>203  |
| F6690EIN       | 6.00 x 6.00<br>152 x 152   | 10.00<br>254 |
| F8890EIN       | 8.00 x 8.00<br>203 x 203   | 12.00<br>305 |
| F101090EIN     | 10.00 x 10.00<br>254 x 254 | 14.00<br>356 |
| F121290EIN     | 12.00 x 12.00<br>305 x 305 | 16.00<br>406 |

### 45-DEGREE ELBOW

For continuous run with 45-degree turns. Top and inside covers removable.

BULLETIN: F40PF

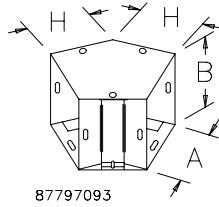

| Catalog Number | AxB in./mm                 | H in./mm    |
|----------------|----------------------------|-------------|
| F22G45E        | 2.50 x 2.50<br>64 x 64     | 2.75<br>70  |
| F33G45E        | 3.00 x 3.00<br>76 x 76     | 2.99<br>76  |
| F44G45E        | 4.00 x 4.00<br>102 x 102   | 3.38<br>86  |
| F66G45E        | 6.00 x 6.00<br>152 x 152   | 4.25<br>108 |
| F88G45E        | 8.00 x 8.00<br>203 x 203   | 5.06<br>129 |
| F1010G45E      | 10.00 x 10.00<br>254 x 254 | 6.00<br>152 |
| F1212G45E      | 12.00 x 12.00<br>305 x 305 | 6.75<br>171 |

### TELESCOPE FITTING

Length easily adjusts to approximately 12.00 in. (305 mm). No cutting or welding required.

BULLETIN: F40PF

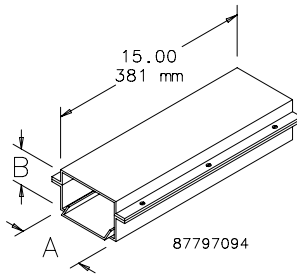

| Catalog Number | AxB in./mm                 |
|----------------|----------------------------|
| F22GA          | 2.50 x 2.50<br>64 x 64     |
| F44GA          | 4.00 x 4.00<br>102 x 102   |
| F66GA          | 6.00 x 6.00<br>152 x 152   |
| F88GA          | 8.00 x 8.00<br>203 x 203   |
| F1010GA        | 10.00 x 10.00<br>254 x 254 |
| F1212GA        | 12.00 x 12.00<br>305 x 305 |

These items not UL/cUL listed.

### OPEN ADAPTER

Used with the 90-Degree Elbow-Tee-Cross fitting to permit a run directly up or down.

BULLETIN: F40PF

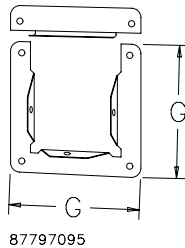

| Catalog Number | G (in.) | G (mm) |
|----------------|---------|--------|
| F22GOA         | 4.50    | 114    |
| F44GOA         | 6.00    | 152    |
| F66GOA         | 8.00    | 203    |
| F88GOA         | 10.00   | 254    |
| F1010GOA       | 12.00   | 305    |
| F1212GOA       | 14.00   | 356    |

### PANEL ADAPTER

A flanged fitting which allows the wireway to be securely connected to an enclosure.

BULLETIN: F40PF

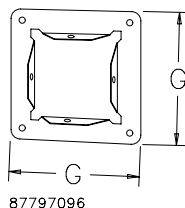

| Catalog Number | G (in.) | G (mm) |
|----------------|---------|--------|
| F22GPA         | 4.50    | 114    |
| F33GPA         | 5.00    | 127    |
| F44GPA         | 6.00    | 152    |
| F66GPA         | 8.00    | 203    |
| F88GPA         | 10.00   | 254    |
| F1010GPA       | 12.00   | 305    |
| F1212GPA       | 14.00   | 356    |

### CLOSURE PLATE

Closes the end of a wireway section or run.

BULLETIN: F40PF

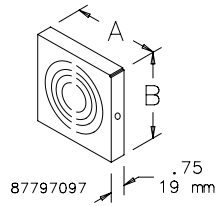

### REDUCER

Reduces wireway to a smaller size.

BULLETIN: F40PF

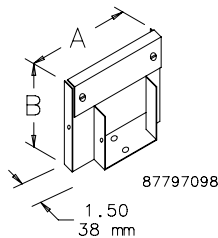

### DROP AND BRACKET HANGERS

Drop and bracket hangers support a wireway run.

BULLETIN: F40PF

| Catalog Number | N max.<br>(in.) | N max.<br>(mm) | P<br>(in.) | P<br>(mm) | R<br>(in.) | R<br>(mm) | S<br>(in.) | S<br>(mm) | T<br>(in.) | T<br>(mm) |
|----------------|-----------------|----------------|------------|-----------|------------|-----------|------------|-----------|------------|-----------|
| F22GDB         | 8.50            | 216            | 4.50       | 114       | 3.38       | 86        | 7.25       | 184       | 3.75       | 95        |
| F44GDB         | 10.50           | 267            | 6.00       | 152       | 4.12       | 105       | 9.25       | 235       | 4.50       | 114       |
| F66GDB         | 15.00           | 381            | 7.12       | 181       | 5.12       | 130       | 13.75      | 349       | 5.50       | 140       |
| F88GDB         | 21.00           | 533            | 10.81      | 275       | 7.00       | 178       | 13.75      | 349       | 7.75       | 197       |
| F1010GDB       | 22.00           | 559            | 13.81      | 335       | 8.38       | 213       | 13.75      | 349       | 10.25      | 260       |
| F1212GDB       | 23.00           | 584            | 15.56      | 395       | 9.78       | 248       | 13.75      | 349       | 12.50      | 318       |

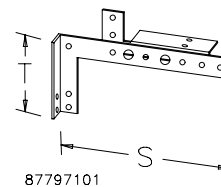
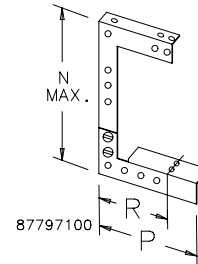

### SUPPORT HANGER

For floor or wall installations.

BULLETIN: F40PF

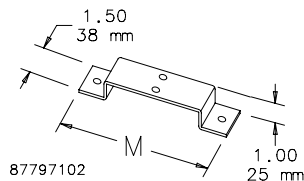

| Catalog Number | AxB in.       | AxB mm    | Knockouts         |
|----------------|---------------|-----------|-------------------|
| F22GCP         | 2.50 x 2.50   | 64 x 64   | With knockouts    |
| F22GCPNK       | 2.50 x 2.50   | 64 x 64   | Without knockouts |
| F44GCP         | 4.00 x 4.00   | 102 x 102 | With knockouts    |
| F33GCPNK       | 3.00 x 3.00   | 76 x 76   | Without knockouts |
| F44GCPNK       | 4.00 x 4.00   | 102 x 102 | Without knockouts |
| F66GCP         | 6.00 x 6.00   | 152 x 152 | With knockouts    |
| F66GCPNK       | 6.00 x 6.00   | 152 x 152 | Without knockouts |
| F88GCP         | 8.00 x 8.00   | 203 x 203 | With knockouts    |
| F88GCPNK       | 8.00 x 8.00   | 203 x 203 | Without knockouts |
| F1010GCP       | 10.00 x 10.00 | 254 x 254 | With knockouts    |
| F1010GCPNK     | 10.00 x 10.00 | 254 x 254 | Without knockouts |
| F1212GCP       | 12.00 x 12.00 | 305 x 305 | With knockouts    |
| F1212GCPNK     | 12.00 x 12.00 | 305 x 305 | Without knockouts |

| Catalog Number | AxB in./mm                 |
|----------------|----------------------------|
| F33G22R        | 3.00 x 3.00<br>76 x 76     |
| F44G22R        | 4.00 x 4.00<br>102 x 102   |
| F44G33R        | 4.00 x 4.00<br>101 x 101   |
| F66G44R        | 6.00 x 6.00<br>152 x 152   |
| F88G66R        | 8.00 x 8.00<br>203 x 203   |
| F1010G88R      | 10.00 x 10.00<br>254 x 254 |
| F1212G88R      | 12.00 x 12.00<br>305 x 305 |
| F1212G1010R    | 12.00 x 12.00<br>305 x 305 |

| Catalog Number | AxB in./mm                 | M<br>in./mm  |
|----------------|----------------------------|--------------|
| F22GSH         | 2.50 x 2.50<br>64 x 64     | 4.62<br>117  |
| F44GSH         | 4.00 x 4.00<br>102 x 102   | 6.12<br>155  |
| F66GSH         | 6.00 x 6.00<br>152 x 152   | 8.12<br>206  |
| F88GSH         | 8.00 x 8.00<br>203 x 203   | 10.12<br>257 |
| F1010GSH       | 10.00 x 10.00<br>254 x 254 | 12.12<br>308 |
| F1212GSH       | 12.00 x 12.00<br>305 x 305 | 14.12<br>359 |

### UNIVERSAL U-CONNECTOR

Joins wireway sections and fittings. Top swings aside to retain the lay-in feature. One U-connector required at each wireway joint except telescope fittings, panel adapters, open adapters, closure plates or reducers.

**BULLETIN: F40PF**

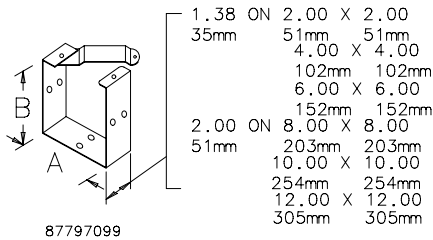

| Catalog Number | AxB in./mm                 |
|----------------|----------------------------|
| F22GUC         | 2.50 x 2.50<br>64 x 64     |
| F33GUC         | 3.00 x 3.00<br>76 x 76     |
| F44GUC         | 4.00 x 4.00<br>102 x 102   |
| F66GUC         | 6.00 x 6.00<br>152 x 152   |
| F88GUC         | 8.00 x 8.00<br>203 x 203   |
| F1010GUC       | 10.00 x 10.00<br>254 x 254 |
| F1212GUC       | 12.00 x 12.00<br>305 x 305 |

### BARRIER KIT, BOLT-ON

Divides wireway into two or more compartments. Barriers are fastened to wireway sections with screws. Sealing washers are included.

**BULLETIN: F20**

| Catalog Number | W in./mm    |
|----------------|-------------|
| F33BK60        | 2.00<br>51  |
| F44BK60        | 3.00<br>76  |
| F66BK60        | 4.50<br>114 |
| F88BK60        | 6.00<br>152 |

