

# Catalogue No: **MOD6RCCB4-40-30**

## RCCB MOD6 3P+N 40A 30mA TYPE AC

Power Distribution and Protection > Circuit Breakers > Miniature Circuit Breakers and Earth Leakage Protection (RCDs and RCBOs) > MOD6 Residual Current Device > MOD6 RCCBs (Safety Switches) > Type AC



Representative Photo Only  
(actual product may vary based on configuration selections)

### MOD6 RCCB, 4P, 6kA, 30mA, 40A

- Complies with AS/NZS 61008 (RCCBs)
- MOD6 RCCBs feature 6kA conditional short circuit rating
- 1P+N and 3P+N for single or three phase loads
- Type AC or Type A RCD option
- 30mA sensitivity featured as standard simplifying the selection for personnel protection applications
- Fast connection pin/fork busbar comb or busbar chassis
- Suits pole covers and loadcentres
- Approval No NSW17482 or RCM Mark

#### SPECIFICATIONS

Product Series	MOD6
Component Type Power Distribution & Protection	RCD
RCD Type, AS/NZS 61008/61009	AC
Tripping Time at $I_{\Delta n}$ , Instantaneous	<40 ms
$I_n$ , Rated Current at 30°C	40 A @30°C
$I_{\Delta c}$ , Rated Conditional Residual Short-Circuit Current	6 kA
$I_{\Delta n}$ , Rated Leakage Current	30 mA
Poles	3P + N
Neutral Pole Protected	No
Rated Frequency	50 / 60 Hz
$U_n$ , Nominal Operational Voltage, AC	415 V AC
$U_{bmin}$ , Service Voltage, AC, Min	287 V AC
$U_{bmax}$ , Service Voltage, AC, Max	455 V AC
Selectivity Class (IEC 60898)	A
$I_m$ , Rated Make/Break Capacity	400 A
$I_{\Delta m}$ , Rated Residual Make/Break Capacity	400 A
$I_{nc}$ , Rated Conditional Short Circuit Current	10 kA
$I_{\Delta c}$ , Rated Conditional Residual Short-Circuit Current	6000 A
$I_{cn}$ , Rated Short Circuit Capacity	6 kA
Isolator Application, IEC 60947-2	Yes
$U_i$ , Rated Insulation Voltage	500 V (rms)
$U_i$ , Rated Insulation Voltage @ Pollution Degree 2	500 V
Insulation Resistance	1000 M $\Omega$
Dielectric Strength	2500V V AC
Electrical Service Life at $U_n$ , $I_n$	10000 cycles
Mechanical Service Life	20000 cycles
Conductor Entry Position	Top / Bottom
IP Rating, Inside	IP40

# Catalogue No: **MOD6RCCB4-40-30**

## RCCB MOD6 3P+N 40A 30mA TYPE AC

Power Distribution and Protection > Circuit Breakers > Miniature Circuit Breakers and Earth Leakage Protection (RCDs and RCBOs) > MOD6 Residual Current Device > MOD6 RCCBs (Safety Switches) > Type AC



IP Rating, Outside	IP20
Flammability Rating (UL94)	UL 94 V-2
Wire / Conductor Size, Rigid Cable, Top, Max	50 mm <sup>2</sup> Top
Wire / Conductor Size, Rigid Cable, In, Min	1.5 mm <sup>2</sup> In
Wire / Conductor Size, Flex Cable, Top, Max	35 mm <sup>2</sup> Top
Wire / Conductor Size, Rigid Cable, Out, Min	1.5 mm <sup>2</sup> Out
Wire / Conductor Size, Rigid Cable, Bottom, Max	50 mm <sup>2</sup> Bottom
Wire / Conductor Size, Flex Cable, In, Min	1.5 mm <sup>2</sup> In
Wire / Conductor Size, Flex Cable, Bottom, Max	35 mm <sup>2</sup> Bottom
Wire / Conductor Size, Flex Cable, Out, Min	1.5 mm <sup>2</sup> Out
Tightening Torque, Top, Nominal	5 Nm
Tightening Torque, Bottom, Nominal	5 Nm
Busbar System, Top	Fork Pin
Busbar System, Bottom	Fork Pin
Trip-Free Mechanism	Yes
Mounting	DIN-35 Rail Mount
Sealable	Yes
Centre Trip Position	No
Height	86 mm
Width	72 mm
Depth	76 mm
Weight	0.368 kg
Package Quantity	1 qty
Approval(s)	N17482
Neutral Pole Switched	Yes
Operating Temperature, Min	-5 °C min
Operating Temperature, Max	55 °C max
Storage Temperature, Min	-25 °C min
Storage Temperature, Max	70 °C max
Relative Humidity, Max	95 %RH
Shock Acceleration (Max.)	40 g
Shock Duration (Max.)	5 ms
Shock Rating	IEC 60077-16-3
Vibration Acceleration (Max.)	1.5 m/s <sup>2</sup>
Vibration Frequency, Operational (Max.)	80 Hz
Vibration Duration (Max.)	30 min
Vibration Rating	IEC 60068-2-6
Standards Compliance	AS/NZS 61008 AS/NZS 61008-1 AS/NZS 61009 IEC 60077-16-3 IEC 60947-2
Certifications	RCM

# Catalogue No: **MOD6RCCB4-40-30**

## RCCB MOD6 3P+N 40A 30mA TYPE AC

Power Distribution and Protection > Circuit Breakers > Miniature Circuit Breakers and Earth Leakage Protection (RCDs and RCBOs) > MOD6 Residual Current Device > MOD6 RCCBs (Safety Switches) > Type AC



REFERENCES	
IECEX Certificate	-
Supplier Declaration of Conformity:	<a href="#">MOD6RCCBxxxxx_Supplier Declaration of Conformity (SDoC)</a>
Installation Guide:	-
User Manual:	-
Manufacturer Datasheet:	-
Manufacturer Catalogue & Product Selection:	-

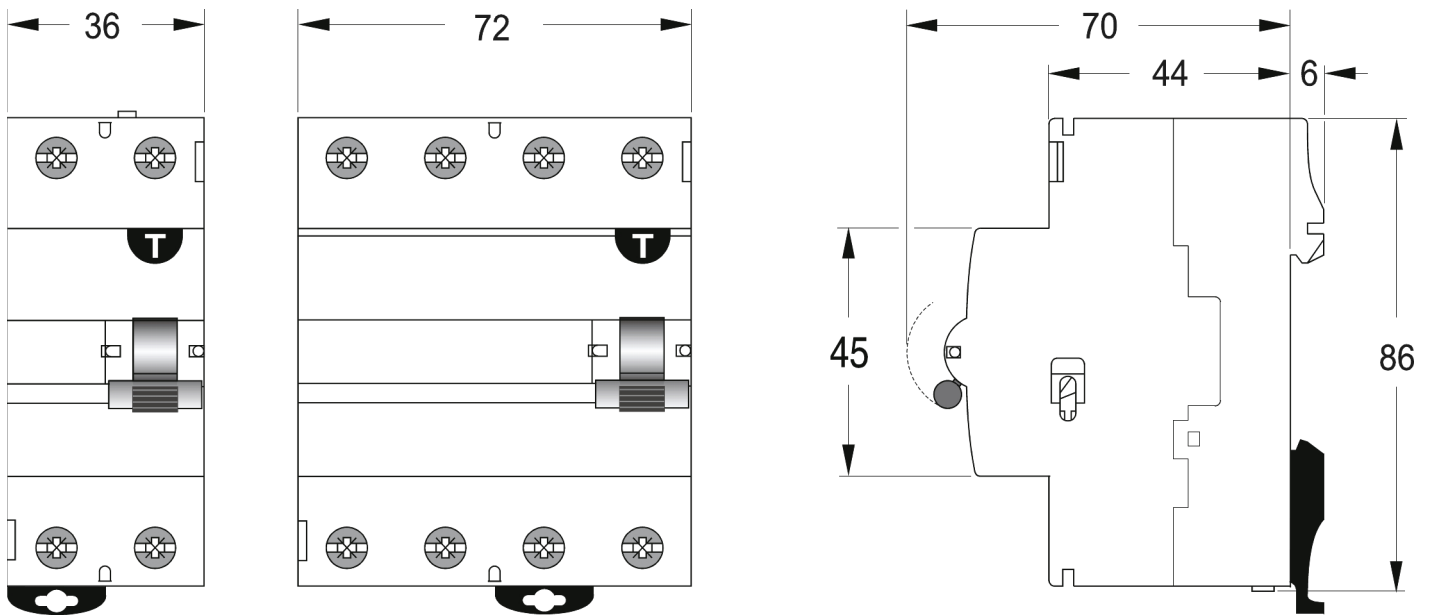

Dimension Diagram

# Catalogue No: **MOD6RCCB4-40-30**

## RCCB MOD6 3P+N 40A 30mA TYPE AC

Power Distribution and Protection > Circuit Breakers > Miniature Circuit Breakers and Earth Leakage Protection (RCDs and RCBOs) > MOD6 Residual Current Device > MOD6 RCCBs (Safety Switches) > Type AC



**RCCB 2 P**  
(127/230 V)

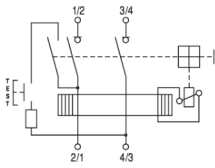
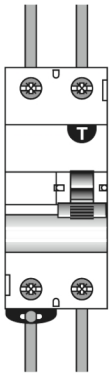

**RCCB 4 P**  
4 P (240/415 V)    3 P (240/415 V)    2 P (240 V)

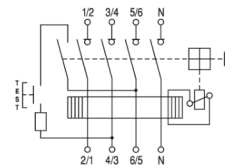
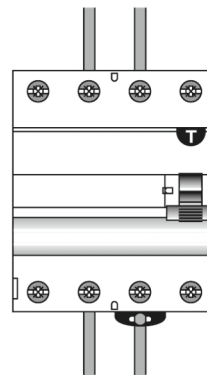
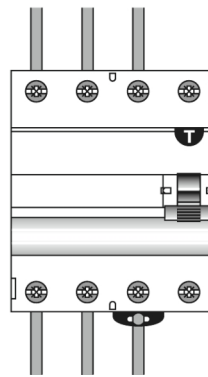
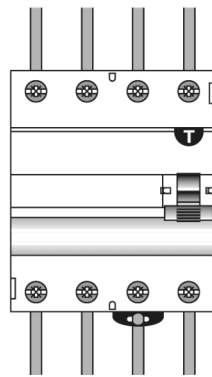

Connection / Wiring Diagram