

Diva® 250 W C•L® Dimmer

Dimmer for CFL, LED, Halogen, and Incandescent dimmable bulbs.

Features

- Large paddle switch with a captive linear-slide dimmer for a standard designer wallplate opening
- HED™ Technology: Advanced Lutron® dimming circuitry designed for compatibility with most high efficacy light bulbs
- UL® Listed to control:
 - Dimmable compact fluorescent (CFL) with integrated ballast
 - Dimmable LED with integrated driver
 - Lutron Hi-lume® A-Series LTE LED Driver
 - Halogen
 - Incandescent
- Low-end adjustment to accommodate a wide range of bulbs
- 100% factory tested
- NEMA SSL-7A Type 2 Compliant

Application Requirements

- **When dimming CFLs or LEDs, only bulbs marked or rated as DIMMABLE may be used.**
- For a list of compatible DIMMABLE CFLs and LEDs please visit www.lutron.com/dimcflled. For questions call 1.800.523.9466.
- Some DIMMABLE CFLs and LEDs require a minimum number of bulbs for proper operation. For details and a list of bulbs, please visit www.lutron.com/dimcflled.

Model Numbers

DVCL-253P-XX¹ Gloss Finish, Single pole/3-way²

DVSCCL-253P-XX¹ Satin Colors®, Single pole/3-way²

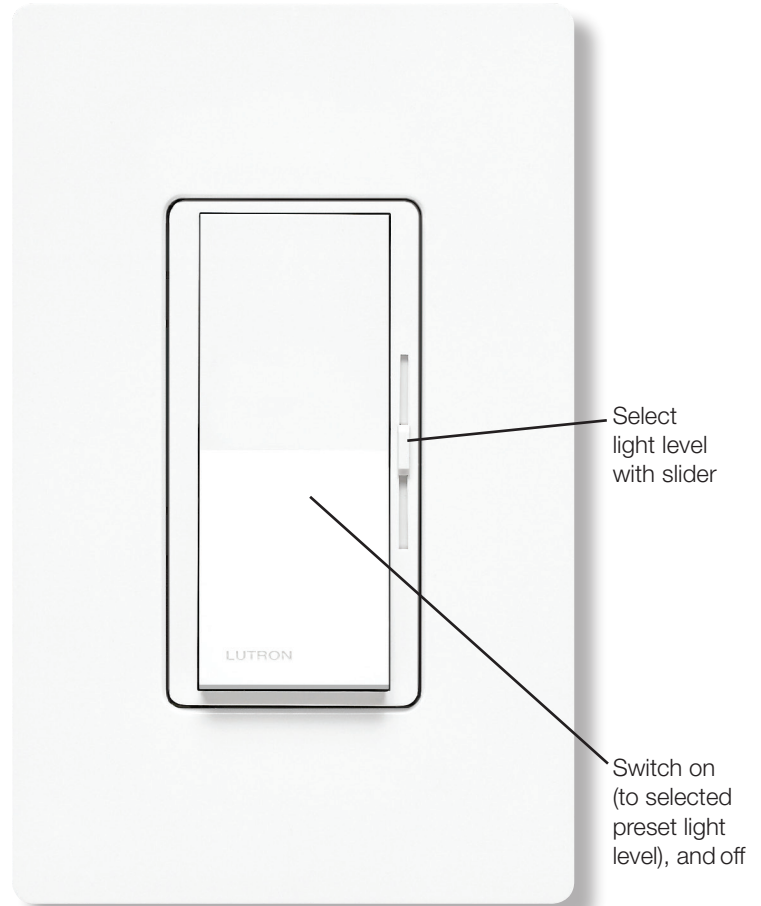

Select light level with slider

Switch on (to selected preset light level), and off

* Wallplate sold separately

¹ "XX" in the model number represents color/finish code; see "Colors and Finishes" on Page 3.

² For 3-way and 4-way switching, use Claro® switches or other mechanical switches.

LUTRON® SPECIFICATION SUBMITTAL

Page

Job Name:	Model Numbers:
Job Number:	

Specifications

Regulatory Approvals

- UL® Listed to US and Canadian safety requirements
UL1472 / CSA C22.2 184.1
- NEMA SSL-7A Type 2

Power and Ratings

- 120 V~ 60 Hz
- 250 W dimmable CFL/LED
- or**
- 600 W Incandescent/Halogen
- or**
- Mixed bulb type per **Multigang and Mixed Bulb Type Ratings** table
- 350W Lutron® Hi-lume® A series LTE LED Driver
(maximum 8 drivers)

Environment

- For indoor use only.
- Ambient operating temperature: 32 °F to 104 °F
(0 °C to 40 °C), 0% - 90% humidity

Performance

- Power failure memory: should power be interrupted, the control will return to its previously set level prior to the interruption when power is restored.
- Captive linear slider
- Tested to withstand electrostatic discharge without damage or memory loss, in accordance with IEC 61000-4-2.
- Precise color matching
- Mechanical air-gap switch to disconnect load power

Warranty

- 1 Year Limited Warranty
For additional Warranty information, please visit
http://www.lutron.com/TechnicalDocumentLibrary/369-119_Wallbox_Warranty.pdf

Job Name:	Model Numbers:
Job Number:	

Dimensions

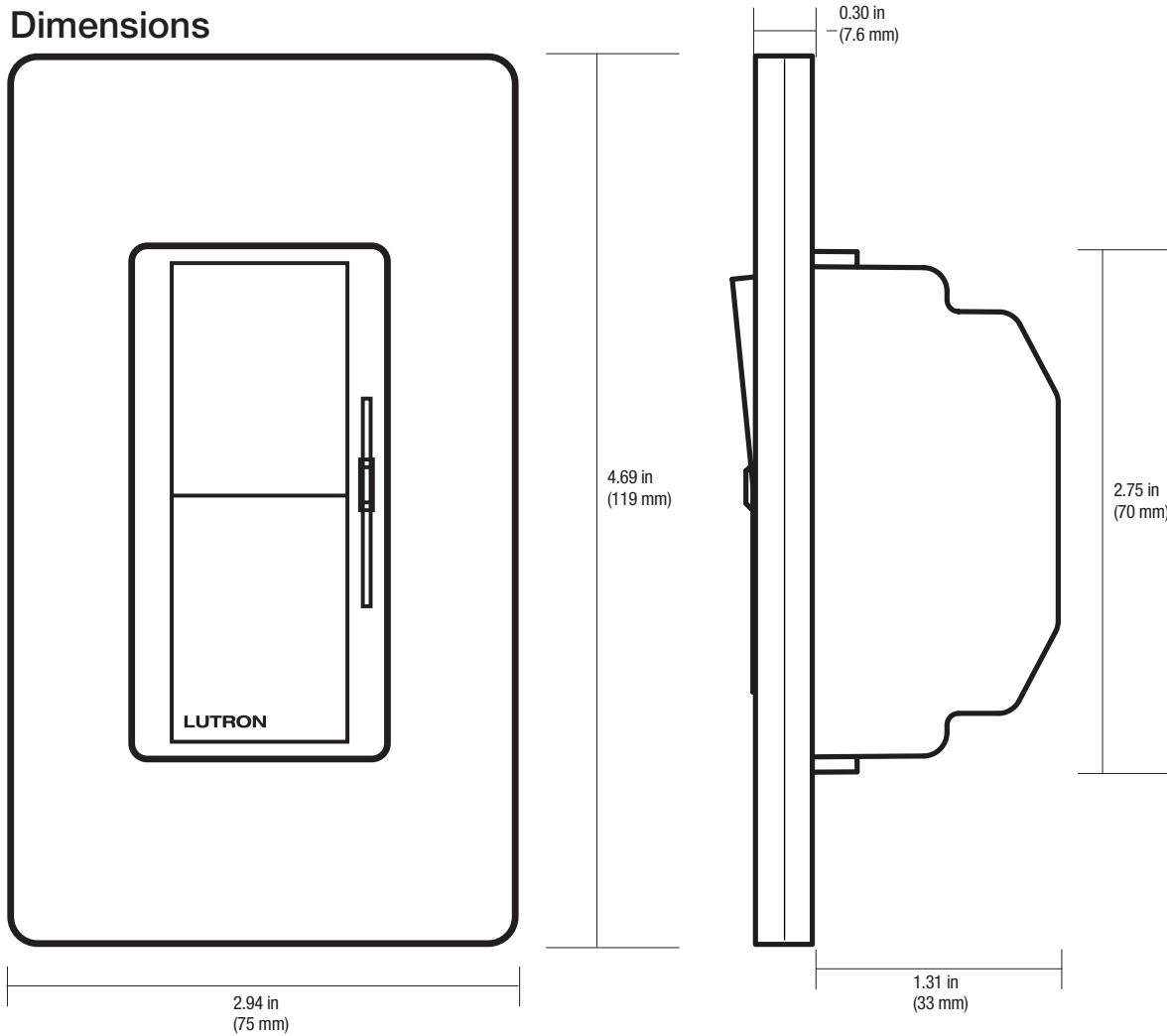

Note: Requires a U.S. wallbox 2½ in (64 mm) deep minimum.

Colors and Finishes

Gloss Finishes

Add color/finish code to model #

Example: DVCL-253P-WH

WH	White
IV	Ivory
AL	Almond
LA	Light Almond
GR	Gray
BR	Brown
BL	Black

Satin Colors

Add color/finish # to model #

Example: DVSCCL-253P-SW

HT	Hot
MR	Merlot
PL	Plum
TQ	Turquoise
SG	Sea Glass
TP	Taupe
ES	Eggshell
BI	Biscuit
SW	Snow
PD	Palladium
MN	Midnight
TC	Terracotta
SI	Sienna
GB	Green Briar
BG	Bluestone
MS	Mocha Stone
GS	Goldstone
DS	Desert Stone
ST	Stone
LS	Limestone

Job Name:	Model Numbers:
Job Number:	

Multigang and Mixed-Bulb-Type Ratings



When installing more than one Dimmer in the same wallbox, it may be necessary to remove some side sections prior to wiring (**see diagram**). Removal of Dimmer side sections may reduce maximum wattage, as shown in the chart below.

Mixing bulb types (**using a combination of CFL/LED, and Incandescent/Halogen bulbs**) will also affect the maximum ratings, as shown in the chart below.

Note: Lutron® Hi-lume® A-Series LTE LED loads cannot be mixed with other loads.

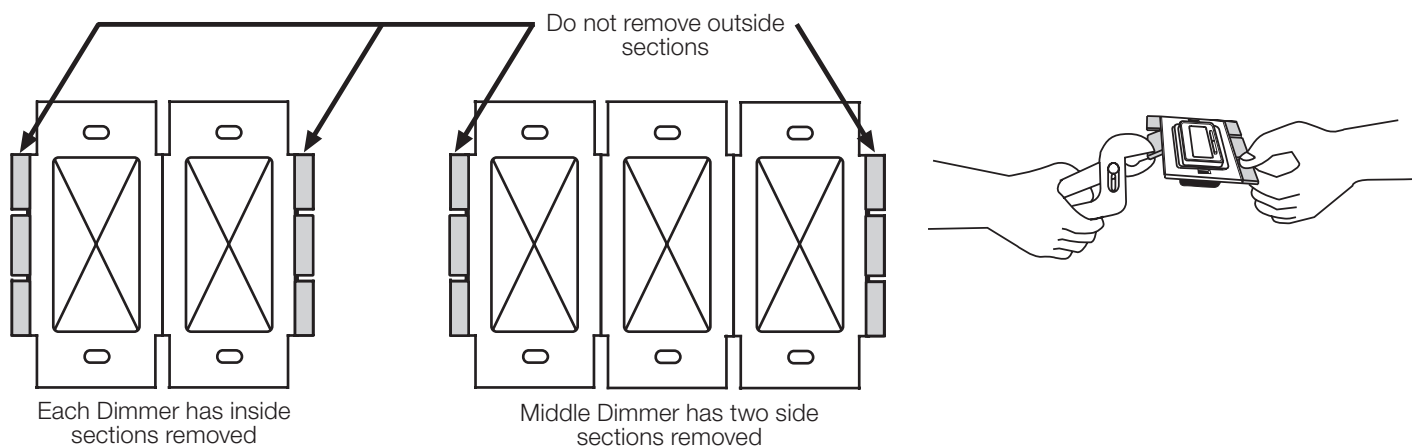
*EXAMPLE: If one set of side sections is removed and you have eight 9 W LED bulbs installed (Total LED Wattage = 72 W), you may add up to 300 W of incandescent or halogen lighting.



Total CFL/LED Wattage Installed (Wattage per bulb x # of bulbs)	Maximum Allowable Incandescent/Halogen Wattage		
	  		
	A No sides removed	B 1 side removed	C 2 sides removed
0 W	+ 600 W	500 W	400 W
1 W – 40 W	+ 500 W	400 W	300 W
41 W – 80 W	+ 400 W	300 W	200 W
81 W – 120 W	+ 300 W	200 W	100 W
121 W – 160 W	+ 200 W	100 W	50 W
161 W – 200 W	+ 100 W	50 W	0 W
201 W – 250 W	+ 0 W	0 W	0 W

Note: There is no wattage reduction when controlling only LED or CFL

Job Name:	Model Numbers:
Job Number:	

Operation (View with wallplate removed)

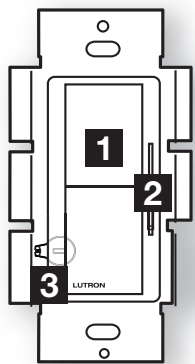

1 Switch
Turns lights ON and OFF.

2 Slider
Controls light level.

+ ↑ **Up**
Increases light level

- ↓ **Down**
Decreases light level

IMPORTANT: Set slider to bottom before adjusting dimming range.

Lever-type Adjustment Dial

3 Adjustment lever
Sets low end dimming limit.

Up (clockwise)
Increases brightness

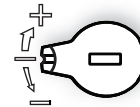

Down (counter-clockwise)
Decreases brightness

Job Name:	Model Numbers:
Job Number:	

Wiring Diagrams

Single-Pole Wiring

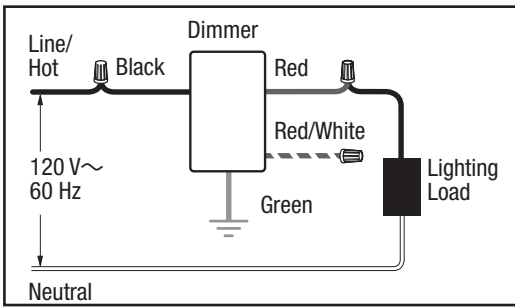

3-Way Wiring

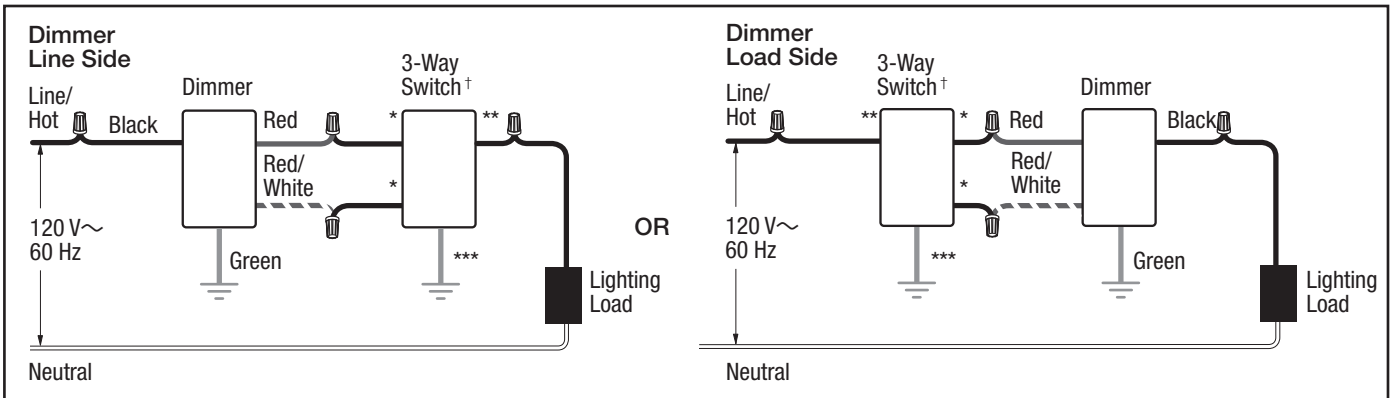

4-Way Wiring

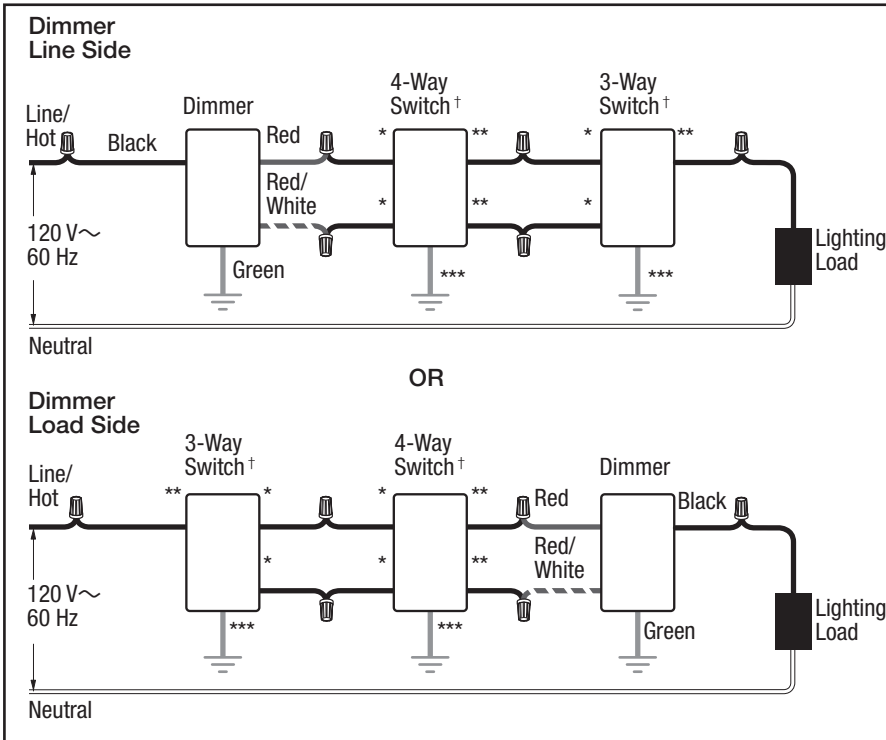

* Copper/Black screw terminal

** Brass/Gold screw terminal

*** Green screw terminal

† Please refer to switch instruction sheet for proper wiring.

Note for 4-Way Wiring:

Dimmer must be installed Line Side or Load Side. It cannot be installed in the 4-way location.

Job Name:	Model Numbers:
Job Number:	