



Wiring Device-Kellems

KP18  
KP82  
KP126  
KP2148  
KP2168  
KP262

**POLYTRAK FACE PLATES**

**INSTALLATION INSTRUCTIONS**

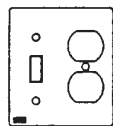
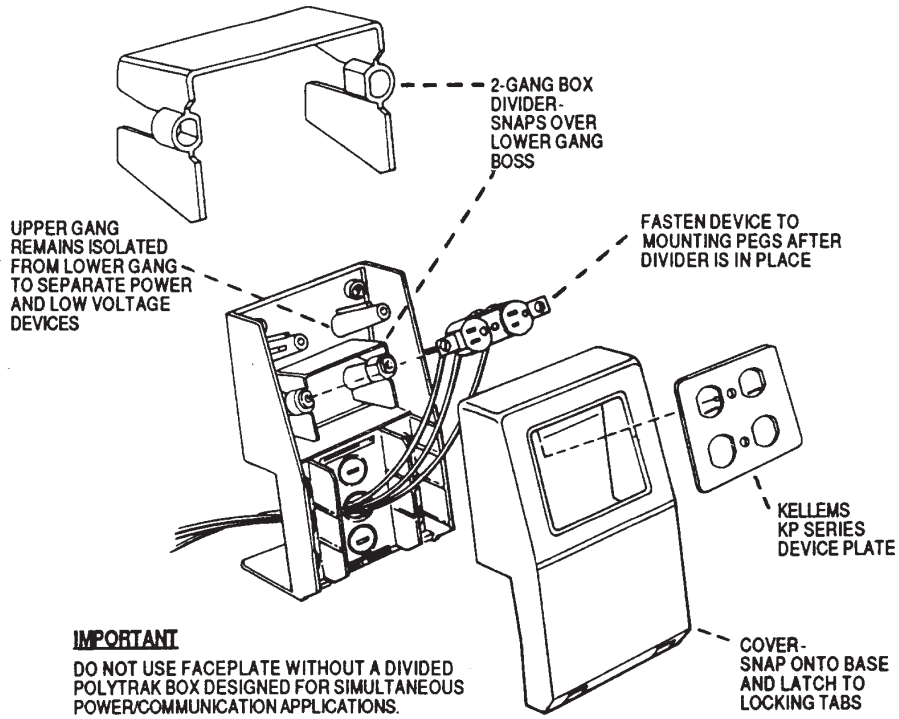

KP18

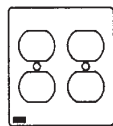

KP82

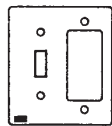

KP126

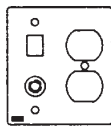

KP2148

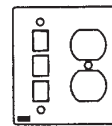

KP2168

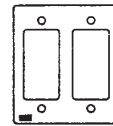

KP262

Wiring Device-Kellems  
Hubbell Incorporated  
1613 State Street  
P.O.Box 3999  
Bridgeport, CT 06605  
tel. (203) 337-3100

