

Technical Data

MATERIALS

Carbon Steel

Channels made from high-quality carbon steel are continuously roll formed to precise dimensions. By cold working the steel mechanical properties are increased, allowing lightweight structures to carry the required load. Corrosion resistance of carbon steel varies widely with coating and alloy. See "Finishes" for more detailed information.

Stainless Steel

Stainless steel channel is available in AISI Type 304 or 316 material. Both are non-magnetic and belong to the austenitic stainless steels group, based on alloy content and crystallographic structure. Like carbon steel, stainless steel exhibits increased strength when cold worked by roll-forming.

Several conditions make the use of stainless steel ideal. These include reducing long term maintenance costs, high ambient temperatures, appearance, and stable structural properties such as yield strength, and high creep strength.

Type 304 resists most organic chemicals, dyestuffs and a wide variety of inorganic chemicals at elevated or cryogenic temperatures. Type 316 contains slightly more nickel and adds molybdenum to give it better corrosion resistance in chloride and sulfuric acid environments. For more information concerning the differences between types 304 and 316, visit www.cooperblinc.com/contactus.

Aluminum

Standard aluminum channel is extruded from aluminum alloy 6063-T6. Strut fittings are made from aluminum alloy 5052-H32.

The high strength to weight ratio of channel made of aluminum helps greatly reduce the overall cost of installation through ease of handling and field cutting.

Aluminum owes its excellent corrosion resistance to its ability to form an aluminum oxide film that immediately reforms when scratched or cut. In most outdoor applications, aluminum has excellent resistance to "weathering". The resistance to chemicals, indoor or outdoor, can best be determined by tests conducted by the user with exposure to the specific conditions for which it is intended. The corrosion resistance of aluminum to some commonly known chemicals is shown in the Corrosion Chart. For further information, contact us or the Aluminum Association.

Fiberglass

We offer two fire retardant (FR) resins for strut systems, polyester and vinyl ester. Both resins are ideal for corrosive environments or nonconductive applications with moderate strength requirements. Some common types of environments where Vinyl Ester Resins are recommended, that Poly Esters are not, are paper mills, most any metal plating operation and any condition with

concentrated levels of Chlorine, [Cl⁻]. Please consult our fiberglass corrosion resistance charts on pg. 183 for specific chemical recommendation data.

Unlike other base materials depicted in this catalog, fiberglass exhibits unique physical property changes when operating in elevated temperature conditions that are a fraction of increase compared to steel or aluminum. Thus, it is advised against using fiberglass in temperatures greater than 200° F.

Please refer to the "Corrosion Resistance Guide" below for specific applications.

The fiberglass strut systems are manufactured from glass fiber-reinforced plastic shapes that meet ASTM E-84, Class 1 Flame Rating and self-extinguishing requirements of ASTM D-635. A surface veil is applied during pultrusion to insure a resin-rich surface and ultraviolet resistance.

While polyester is sufficient for most uses, vinyl ester is suitable for a broader range of environments.

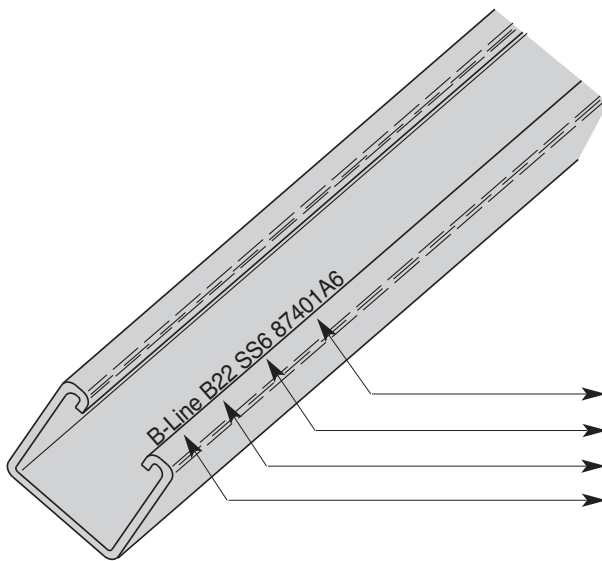

B-Line Steel Strut is stamped with:

- Traceable to the steel's origin
- Material/Finish
- B-Line part number designation
- Company Name

FINISHES

Zinc Coatings

Zinc protects steel in two ways. First it protects the steel as a coating and second as a sacrificial anode to repair bare areas such as cut edges, scratches, and gouges. The corrosion protection of zinc is directly related to its thickness and the environment. This means a .2 mil coating will last twice as long as a .1 mil coating in the same environment.

Galvanizing also protects cut and drilled edges.

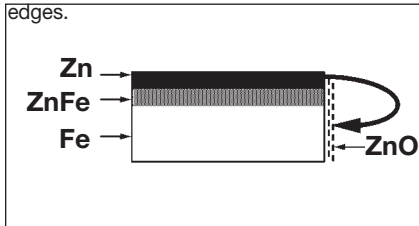

Electrogalvanized Zinc

Electrogalvanized Zinc (also known as zinc plated or electroplated) is the process by which a coating of zinc is deposited on the steel by electrolysis from a bath of zinc salts.

A rating of SC3, our standard, provides a minimum zinc coating thickness of .5 mils (excluding hardware, which is SC1 = .2 mils).

When exposed to air and moisture, zinc forms a tough, adherent, protective film consisting of a mixture of zinc oxides, hydroxides, and carbonates. This film is in itself a barrier coating which slows subsequent corrosive attack on the zinc. This coating is usually recommended for indoor use in relatively dry areas, as it provides ninety-six hours protection in salt spray testing per ASTM B117.

Chromium/ Zinc

Chromium/ Zinc is a corrosion resistant composition, which was developed to protect fasteners and small bulk items for automotive use. The coating applications have since been extended to larger parts and other markets.

Chromium/Zinc composition is an aqueous coating dispersion containing chromium, proprietary organics, and zinc flake.

This finish provides 500 hours protection in salt spray testing per ASTM B117.

Pre-Galvanized Zinc

(Mill galvanized, hot dip mill galvanized or continuous hot dip galvanized) Pre-galvanized steel is produced by coating coils of sheet steel with zinc by continuously rolling the material through molten zinc at the mills. This is also known as mill galvanized or hot dip mill galvanized. These coils are then slit to size and fabricated by roll forming, shearing, punching, or forming to produce our pre-galvanized strut products.

The G90 specification calls for a coating of .90 ounces of zinc per square foot of steel. This results in a coating of .45 ounces per square foot on each side of the sheet. This is important when comparing this finish to hot dip galvanized after fabrication.

During fabrication, cut edges and welded areas are not normally zinc coated; however, the zinc near the uncoated metal becomes a sacrificial anode to protect the bare areas after a short period of time.

Hot Dip Galvanized After Fabrication (Hot dip galvanized or batch hot dip galvanized)

Hot dip galvanized strut products are fabricated from steel and then completely immersed in a bath of molten zinc. A metallic bond occurs resulting in a zinc coating that completely coats all surfaces, including edges and welds.

Another advantage of this method is coating thickness. Strut products that are hot dip galvanized after fabrication have a minimum thickness of 1.50 ounces per square foot on each side, or a total 3.0 ounces per square foot of steel, according to ASTM A123.

The zinc thickness is controlled by the amount of time each part is immersed in the molten zinc bath as well as the speed at which it is removed. The term "double dipping" refers to parts too large to fit into the galvanizing kettle and, therefore, must be dipped one end at a time. It does not refer to extra coating thickness.

The layer of zinc which bonds to steel provides a dual protection against corrosion. It protects first as an overall barrier coating. If this coating happens to be scratched or gouged, zinc's secondary defense is called upon to protect the steel by galvanic action.

Hot-Dip Galvanized After Fabrication is recommended for prolonged outdoor exposure and will usually protect steel for 20 years or more in most atmospheric environments and in many industrial environments. For best results, a zinc rich paint (available from B-Line) should be applied to field cuts. The zinc rich paint will provide immediate protection for these areas and eliminate the short time period for galvanic action to "heal" the damaged coating.

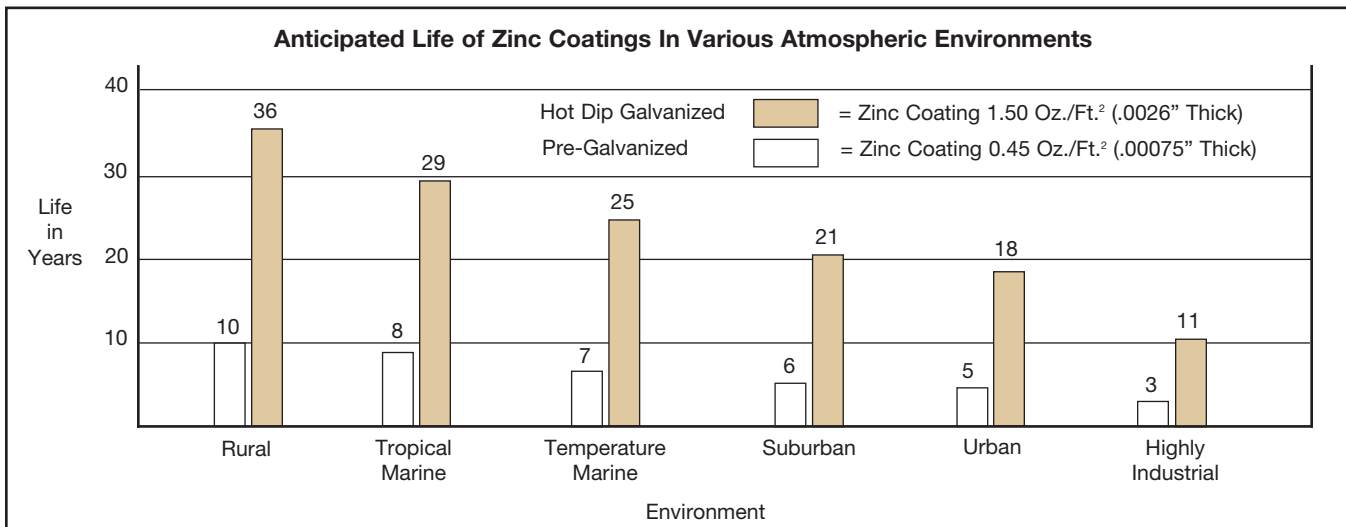

Technical Data

DURA-GREEN™ and DURA-COPPER™ Epoxy Coatings

DURA-GREEN and DURA-COPPER epoxy coatings are water borne epoxy coatings applied to B-Line products by a precisely controlled cathodic electro-deposition process. This process is accomplished using a conveyor to transport channel and fittings through several cleaning, phosphatizing and application stages prior to being baked (See diagram below).

This custom-designed paint system is used for painting all channels, channel combinations, slotted angle, and fittings.

Samples are selected on a routine basis for Salt Spray (fog) testing to verify the quality of the finish. These tests are performed in accordance with ASTM B117 and evaluated and related according to ASTM D1654 (Tables 1 & 2).

The DURA-GREEN and DURA-COPPER Epoxy coatings have been tested and listed by Underwriters Laboratories in accordance with "Standard for Surface Metal Raceway and Fittings, UL5" and

"Standard for Pipe Hanger Equipment for Fire Protection Service, UL203".

Due to DURA-GREEN's organically based composition, it seats itself into porous surfaces more completely and efficiently than zinc coatings. As these porous caverns are filled along the material profile, the outer finished surface demonstrates an increased smooth uniform plane which produces considerably less off-gasing when tested.

DURA-GREEN channel meets or exceeds 100 level clean room standards. This was confirmed by testing the channel in accordance with Boeing (PCL) Standards, which are more stringent and complete than ASTM E595-93. DURA-GREEN was found to be a superior finish, due in part to its proven application process.

PVC Coating

Another of the corrosion resistant coatings offered by B-Line is PVC (polyvinyl chloride), applied over steel or aluminum channel and fittings. The PVC coating process begins by cleaning the product

thoroughly. A bonding coat is applied to the part and then preheated to a temperature above the melting point of the coating powder. The product is then passed through a fluidized bed of vinyl plastic powder where the powder particles melt, adhere and flow out to form a smooth continuous coating. The thickness is controlled by the base metal temperature and the immersion time in the bed. It is then post-heated to complete the fusion of the outer surfaces.

The standard coating thickness of B-Line's PVC coated products is 15 mils (.380 mm), plus or minus 5 mils (.125 mm). Since the chemistry, not the thickness of vinyl plastic PVC determines longevity, a coating of 10 to 20 mils (.250 to .500 mm) is more than adequate. If the corrosive conditions are such that the plasticizers are leached out, a thicker coating will do little to extend the life of a coated product.

For certain environments, a plastisol dipped PVC coating is available on request.

PVC coating depends totally on the concept of encapsulation attached to the base metal by a bonding agent. If any hole or discontinuity occurs, the corrosive action can undercut the base metal to a point where all that remains is the PVC.

In the event of field cuts or any other damage to the coating, a liquid PVC patch, available from B-Line, must be applied to maintain the integrity of the coating. After the installation is complete, a thorough inspection should be performed to assure the absence of voids, pinholes, or cuts.

SALT SPRAY TEST RESULTS

Type of Finish	Unscribed 5% Failure (1)	Scribed 1/8" (3.2) Creepage from Scribe (1)
B-Line DURA-GREEN Epoxy	1000 Hours	312 Hours
Mill Galv. (Pre-Galv.) G90	192 Hours	288 Hours
Perma-Green	438 Hours	231 Hours
Zinc Chromate	36 Hours	96 Hours
Industry Green (Range)	10 to 36 Hours	4 to 30 Hours

(1) All salt spray (fog) tests conducted in accordance with ASTM B117 and evaluated and rated according to ASTM D1654 Tables 1 & 2. Tests are performed and certified by an independent testing laboratory.

DURA-GREEN™/DURA-COPPER™ EPOXY COATING PROCESS

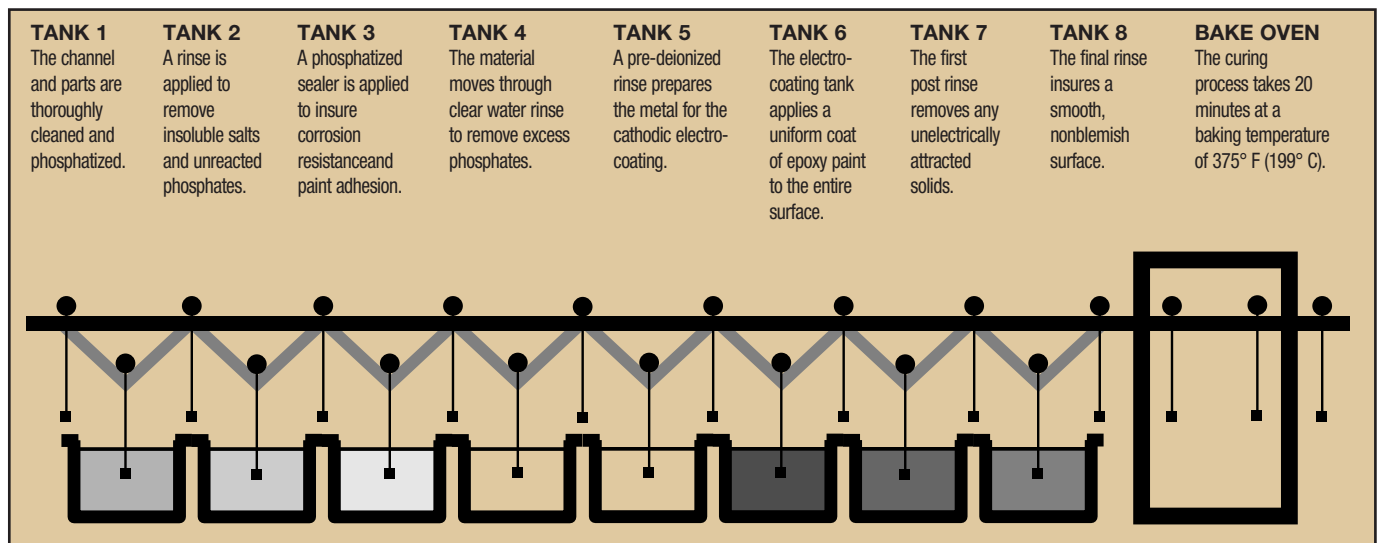

Channel Nuts & Hardware

Channel Nuts

Channel nuts are one of the main components of our metal framing system. It is designed to provide essential gripping power and ease during installation. Channel nuts are press formed, machined and hardened from steel which meets the requirements of ASTM A108 or ASTM A36 for our larger sizes.

Bolts, Screws, and Nuts

All bolts, screws and nuts meet the physical and chemical requirements of ASTM A307, SAE J429 or ASTM A563, and have unified inch screw threads (coarse, UNC). ISO metric threads are also available on special request.

Recommended Torque

Bolt Size	1/4"-20	5/16"-18	3/8"-16	1/2"-13
Foot/Lbs.	6	11	19	50
Nm	8	15	26	68

Bolt Size	M6x1	M8 x1.25	M10 x 1.5	M12x1.75
Nm	12	17	36	62
Foot/Lbs.	9	13	27	46

Materials & Finishes*

Finish Code	Finish	Specification
PLN	Plain	ASTM A108/A307 Gr. A, ASTM A563, SAE J429
ZN	Electro-Plated Zinc	ASTM B633 SC1 Type III
CZ	Chromium Zinc	ASTM F1136 Gr. 3
HDG	Hot-Dipped Galvanized	ASTM A153
SS6	Stainless Steel Type 316	MPIF 35/ASTM F593
AL	Aluminum	ASTM F468 S4

*Unless otherwise noted.

Note: Channel nuts are not available in HDG, Aluminum, or Stainless Steel Type 304

Metric

Metric dimensions are shown in parentheses. Unless noted, all metric dimensions are in millimeters.



Channel Nuts & Hardware

STANDARD CHANNEL NUTS

Numbering Example:

N 7 25 (*) WO

Nut Type	Channel Type	Thread Size	Stud Length	Suffix
N = Standard Nut	7 = Tall Channels	21 = #8-32	* = Specify Length of stud below for Stud Nut or Twirl Stud Nuts	WO = Without Spring
TN = Twirl Nut	B11	22 = #10-24	$\frac{3}{4}$ = $\frac{3}{4}$ "	** = Twirl Nuts or nuts with springs have blank suffix
SN = Stud Nut	B12	27 = #10-32	1 = 1"	
STN = Stud Twirl Nut	2 = Medium Channels	24 = $\frac{1}{4}$ -20	$1\frac{1}{4}$ = $1\frac{1}{4}$ "	
NW = Combo Nut Washer	B22	23 = $\frac{5}{16}$ -18	$1\frac{1}{2}$ = $1\frac{1}{2}$ "	
	B24	28 = $\frac{3}{8}$ -16		
	B26	26 = $\frac{7}{16}$ -14		
	B32	25 = $\frac{1}{2}$ -13		
	5 = Short Channels	55 = $\frac{5}{8}$ -11		
	B42	75 = $\frac{5}{8}$ -11		
	B52	78 = $\frac{7}{8}$ -9		
	B54			
	B56			

METRIC CHANNEL NUTS

Numbering Example: **BMS 6 M**

Nut Type	Metric Thread Size	Suffix
BMS = Spring Nut	3 = M3.5	S = Short Spring
BMS-D = Spring Nut ($\frac{1}{2}$ " thick)	4 = M4	M = Medium Spring
BMT = Twirl Nut	5 = M5	L = Long Spring
BMT-D = Twirl Nut ($\frac{1}{2}$ " thick)	6 = M6	* = Twirl Nuts and nuts without springs have blank suffix
BMM = Spring Nut (Mini channel)	8 = M8	
	10 = M10	
	12 = M12	

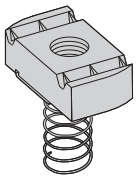

SPRING NUT

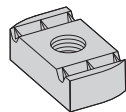

NUT WITHOUT SPRING

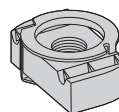

TWIRL-NUT™

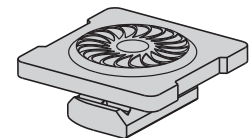

COMBO NUT WASHER

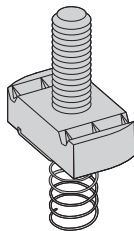

STUD NUT WITH SPRING

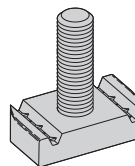

STUD NUT WITHOUT SPRING

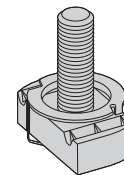

TWIRL STUD NUT

Reference page 44 for general fitting and standard finish specifications.

Note: See page 50 for resistance to slip & page 51 for pull-out strength.

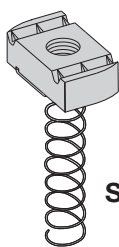

700 Series

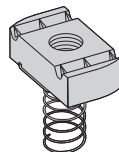

200 Series

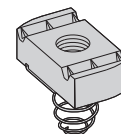

500 Series

SPRING NUT

Part No.	Thread Size	Fits Channel Sizes	Nut Thickness		Wt./C	
					Lbs.	kg
N721	#8-32	B11 & B12	1/4"	(6.3)	7.0	(3.17)
N221	#8-32	B22, B24, B26, B32	1/4"	(6.3)	7.0	(3.17)
N521	#8-32	B42, B52, B54, B56	1/4"	(6.3)	7.0	(3.17)
N727	#10-32	B11 & B12	1/4"	(6.3)	7.0	(3.17)
N227	#10-32	B22, B24, B26, B32	1/4"	(6.3)	7.0	(3.17)
N527	#10-32	B42, B52, B54, B56	1/4"	(6.3)	7.0	(3.17)
N722	#10-24	B11 & B12	1/4"	(6.3)	7.0	(3.17)
N222	#10-24	B22, B24, B26, B32	1/4"	(6.3)	7.0	(3.17)
N522	#10-24	B42, B52, B54, B56	1/4"	(6.3)	7.0	(3.17)
N724	1/4-20	B11 & B12	1/4"	(6.3)	6.7	(3.04)
N224	1/4-20	B22, B24, B26, B32	1/4"	(6.3)	6.7	(3.04)
N524	1/4-20	B42, B52, B54, B56	1/4"	(6.3)	6.7	(3.04)
N723	5/16-18	B11 & B12	1/4"	(6.3)	6.7	(3.04)
N223	5/16-18	B22, B24, B26, B32	1/4"	(6.3)	6.7	(3.04)
N523	5/16-18	B42, B52, B54, B56	1/4"	(6.3)	6.7	(3.04)
N728	3/8-16	B11 & B12	3/8"	(9.5)	9.3	(4.22)
N228	3/8-16	B22, B24, B26, B32	3/8"	(9.5)	9.3	(4.22)
N528	3/8-16	B42, B52, B54, B56	3/8"	(9.5)	9.3	(4.22)
N726	7/16-14	B11 & B12	3/8"	(9.5)	8.8	(3.99)
N226	7/16-14	B22, B24, B26, B32	3/8"	(9.5)	8.8	(3.99)
N526	7/16-14	B42, B52, B54, B56	3/8"	(9.5)	8.8	(3.99)
N725	1/2-13	B11 & B12	1/2"	(12.7)	11.6	(5.26)
N225	1/2-13	B22, B24, B26, B32	1/2"	(12.7)	11.6	(5.26)
N525	1/2-13	B42, B52, B54, B56	3/8"	(9.5)	8.8	(3.99)
N755	5/8-11	B11 & B12	1/2"	(12.7)	16.4	(7.44)
N255	5/8-11	B22, B24, B26, B32	1/2"	(12.7)	16.4	(7.44)
N555	5/8-11	B42, B52, B54, B56	3/8"	(9.5)	10.2	(4.62)
N775	3/4-10	B11 & B12	1/2"	(12.7)	14.5	(6.58)
N275	3/4-10	B22, B24, B26, B32	1/2"	(12.7)	14.5	(6.58)
N575	3/4-10	B42, B52, B54, B56	3/8"	(9.5)	8.8	(3.99)
N778	7/8-9	B11 & B12	1/2"	(12.7)	12.5	(5.67)
N278	7/8-9	B22, B24, B26, B32	1/2"	(12.7)	12.5	(5.67)
Metric Threads						
BMS-6L	M6 x 1	B11 & B12	1/4"	(6.3)	6.9	(3.13)
BMS-6M	M6 x 1	B22, B24, B26, B32	1/4"	(6.3)	6.9	(3.13)
BMS-6S	M6 x 1	B42, B52, B54, B56	1/4"	(6.3)	6.9	(3.13)
BMS-8L	M8 x 1.25	B11 & B12	1/4"	(6.3)	6.7	(3.04)
BMS-8M	M8 x 1.25	B22, B24, B26, B32	1/4"	(6.3)	6.7	(3.04)
BMS-8S	M8 x 1.25	B42, B52, B54, B56	1/4"	(6.3)	6.7	(3.04)
BMS-10L	M10 x 1.5	B11 & B12	3/8"	(9.5)	9.6	(4.35)
BMS-10M	M10 x 1.5	B22, B24, B26, B32	3/8"	(9.5)	9.6	(4.35)
BMS-10S	M10 x 1.5	B42, B52, B54, B56	3/8"	(9.5)	9.6	(4.35)
BMS-12M	M12 x 1.75	B22, B24, B26, B32	3/8"	(9.5)	9.2	(4.17)
BMS-12S	M12 x 1.75	B42, B52, B54, B56	3/8"	(9.5)	9.2	(4.17)
BMS-D-12L	M12 x 1.75	B11 & B12	1/2"	(12.7)	12.2	(5.53)
BMS-D-12M	M12 x 1.75	B22, B24, B26, B32	1/2"	(12.7)	12.2	(5.53)

Note: For mini channel nut information see page 203.

Reference page 44 for general fitting and standard finish specifications.

Channel Nuts

RESISTANCE TO SLIP

- With Safety Factor of 3

Thread Size	Nut Part Numbers	Resistance to Slip					
		12 ga. Channel		14 ga. Channel		16 ga. Channel	
		Lbs.	N	Lbs.	N	Lbs.	N
#8-32	N221, N221WO, N521, N721, TN221	50	220	50	220	50	220
#10-24	N222, N222WO, N522, N722, TN222	100	440	100	440	100	440
#10-32	N227, N227WO, N527, N727, TN227	100	440	100	440	100	440
1/4"-20	NW524*, N224, N224WO, N524, N724, TN224, STN224, SN224WO, SN224, SN524, SN724	300	1330	300	1330	300	1330
5/16"-18	N223, N223WO, N523, N723, TN223	450	2000	450	2000	450	2000
3/8"-16	NW528*, N228, N228WO, N528, N728, TN228, STN228, SN228WO, SN228, SN528, SN728	800	3560	600	2670	600	2670
7/16"-14	N226, N226WO, N526, N726, TN226	1000	4450	800	3560	800	3560
1/2"-13	N225, N225WO, N725, TN225, STN225, SN225WO, SN225, SN725	1500	6670	1000	4450	1000	4450
	NW525*, N525, N525WO, TN525, STN525, SN525WO, SN525	1500	6670	1000	4450	1000	4450
5/8"-11	N255, N255WO, N755, TN255	1500	6670	1000	4450	1000	4450
	N555, N555WO	1500	6670	1000	4450	1000	4450
3/4"-10	N275, N275WO, N775	1500	6670	1000	4450	1000	4450
	N575, N575WO	1500	6670	1000	4450	1000	4450
7/8"-9	N278, N278WO, N778	1500	6670	1000	4450	1000	4450
M6 x 1	BMS-6, BMS-6L, BMS-6M, BMS-6S, BMT-6	300	1330	300	1330	300	1330
M8 x 1.25	BMS-8, BMS-8L, BMS-8M, BMS-8S, BMT-8	450	2000	450	2000	450	2000
M10 x 1.50	BMS-10, BMS-10L, BMS-10M, BMS-10S, BMT-20	800	3560	600	2760	600	2760
M12 x 1.75	BMS-D-12, BMS-D-12L, BMS-D-12M, BMT-D-12	1500	6670	1000	4450	1000	4450
	BMS-12, BMS-12M, BMS-12S, BMT-12	1500	6670	1000	4450	1000	4450

* Combo Nut Washer (see page 49)

Note: When using stainless steel, reduce slip load by 50% due to hardness of material.

Resistance to Slip of Channel Nut

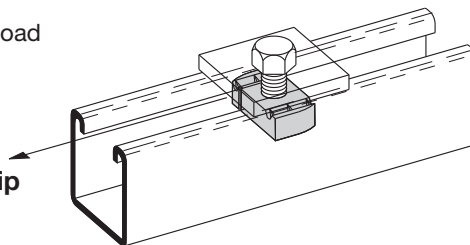

Note: For mini channel nut information see page 203.

Reference page 44 for general fitting and standard finish specifications.

PULL-OUT STRENGTH

- With Safety Factor of 3
- Maximum pullout strength for B11 & B12 channels is limited to 1500 lbs. (6670 N).

Thread Size	Nut Part Numbers	Pull-Out Strength					
		12 ga. Channel		14 ga. Channel		16 ga. Channel	
		Lbs.	N	Lbs.	N	Lbs.	N
#8-32	N221, N221WO, N521, N721, TN221	200	890	200	890	200	890
#10-24	N222, N222WO, N522, N722, TN222	250	1110	250	1110	250	1110
#10-32	N227, N227WO, N527, N727, TN227	250	1110	250	1110	250	1110
1/4"-20	NW524*, N224, N224WO, N524, N724, TN224, STN224, SN224WO, SN224, SN524, SN724	450	2000	450	2000	450	2000
5/16"-18	N223, N223WO, N523, N723, TN223	750	3330	750	3330	750	3330
3/8"-16	NW528*, N228, N228WO, N528, N728, TN228, STN228, SN228WO, SN228, SN528, SN728	1100	4890	1000	4450	1000	4450
7/16"-14	N226, N226WO, N526, N726, TN226	1500	6670	1200	5340	1000	4450
1/2"-13	N225, N225WO, N725, TN225, STN225, SN225WO, SN225, SN725	2000	8900	1400	6230	1000	4450
	NW525*, N525, N525WO, TN525, STN525, SN525WO, SN525	1500	6670	1400	6230	1000	4450
5/8"-11	N255, N255WO, N755, TN255	2000	8900	1400	6230	1000	4450
	N555, N555WO	1500	6670	1400	6230	1000	4450
3/4"-10	N275, N275WO, N775	2000	8900	1400	6230	1000	4450
	N575, N575WO	1500	6670	1400	6230	1000	4450
7/8"-9	N278, N278WO, N778	1500	6670	1400	6230	1000	4450
M6 x 1	BMS-6, BMS-6L, BMS-6M, BMS-6S, BMT-6	450	2000	450	2000	450	2000
M8 x 1.25	BMS-8, BMS-8L, BMS-8M, BMS-8S, BMT-8	750	3330	750	3330	750	3330
M10 x 1.50	BMS-10, BMS-10L, BMS-10M, BMS-10S, BMT-20	1100	4890	1000	4450	1000	4450
M12 x 1.75	BMS-D-12, BMS-D-12L, BMS-D-12M, BMT-D-12	2000	8900	1400	6230	1000	4450
	BMS-12, BMS-12M, BMS-12S, BMT-12	1500	6670	1400	6230	1000	4450

 Channel Nuts & Hardware
Metric Threads

* Combo Nut Washer (see page 49)

Note: When using stainless steel, reduce slip load by 50% due to hardness of material.

Note: For mini channel nut information see page 203.

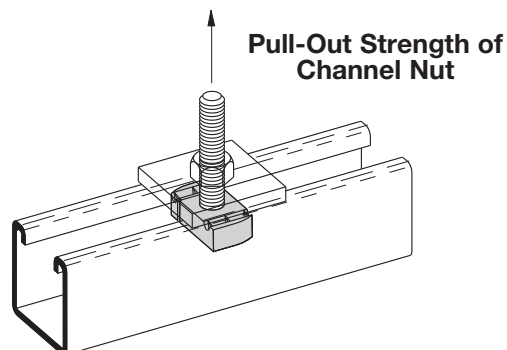

Reference page 44 for general fitting and standard finish specifications.