

Coupling contactor relay, 2 NO + 2 NC, 24 V DC, 0.7 ... 1.25* US, with integrated diode, Size S00, screw terminal suitable for PLC outputs



Product brand name	SIRIUS
Product designation	Coupling relay for switching auxiliary circuits
Product type designation	3RH2
General technical data	
Size of contactor	S00
Product extension	No
• Auxiliary switch	
Degree of pollution	3
Surge voltage resistance rated value	6 kV
Protection class IP	
• on the front	IP20
Shock resistance at rectangular impulse	
• at DC	10g / 5 ms, 5g / 10 ms
Shock resistance with sine pulse	
• at DC	15g / 5 ms, 8g / 10 ms
Mechanical service life (switching cycles)	
• of contactor typical	30 000 000
Reference code acc. to DIN EN 81346-2	K
Reference code acc. to DIN EN 61346-2	K

Ambient conditions

Installation altitude at height above sea level

- maximum 2 000 m

Main circuit

No-load switching frequency

- at AC 10 000 1/h
- at DC 10 000 1/h

Control circuit/ Control

Type of voltage of the control supply voltage

DC

Control supply voltage at DC

- rated value 24 V

Operating range factor control supply voltage rated value of magnet coil at DC

- initial value 0.7
- Full-scale value 1.25

Design of the surge suppressor

with diode

Closing power of magnet coil at DC

2.8 W

Holding power of magnet coil at DC

2.8 W

Closing delay

- at DC 30 ... 100 ms

Opening delay

- at DC 7 ... 13 ms

Arcing time

10 ... 15 ms

Auxiliary circuit

Number of NC contacts for auxiliary contacts

2

- instantaneous contact 2

Number of NO contacts for auxiliary contacts

2

- instantaneous contact 2

Identification number and letter for switching elements

22 E

Operating current at AC-12 maximum

10 A

Operating current at AC-15

- at 230 V rated value 10 A
- at 400 V rated value 3 A
- at 500 V rated value 2 A
- at 690 V rated value 1 A

Operating current at 1 current path at DC-12

- at 24 V rated value 10 A
- at 110 V rated value 3 A
- at 220 V rated value 1 A
- at 440 V rated value 0.3 A













<ul style="list-style-type: none"> • at 600 V rated value 	0.15 A
Operating current with 2 current paths in series at DC-12	
<ul style="list-style-type: none"> • at 24 V rated value 	10 A
<ul style="list-style-type: none"> • at 60 V rated value 	10 A
<ul style="list-style-type: none"> • at 110 V rated value 	4 A
<ul style="list-style-type: none"> • at 220 V rated value 	2 A
<ul style="list-style-type: none"> • at 440 V rated value 	1.3 A
<ul style="list-style-type: none"> • at 600 V rated value 	0.65 A
Operating current with 3 current paths in series at DC-12	
<ul style="list-style-type: none"> • at 24 V rated value 	10 A
<ul style="list-style-type: none"> • at 60 V rated value 	10 A
<ul style="list-style-type: none"> • at 110 V rated value 	10 A
<ul style="list-style-type: none"> • at 220 V rated value 	3.6 A
<ul style="list-style-type: none"> • at 440 V rated value 	2.5 A
<ul style="list-style-type: none"> • at 600 V rated value 	1.8 A
Operating frequency at DC-12 maximum	1 000 1/h
Operating current at 1 current path at DC-13	
<ul style="list-style-type: none"> • at 24 V rated value 	10 A
<ul style="list-style-type: none"> • at 110 V rated value 	1 A
<ul style="list-style-type: none"> • at 220 V rated value 	0.3 A
<ul style="list-style-type: none"> • at 440 V rated value 	0.14 A
<ul style="list-style-type: none"> • at 600 V rated value 	0.1 A
Operating current with 2 current paths in series at DC-13	
<ul style="list-style-type: none"> • at 24 V rated value 	10 A
<ul style="list-style-type: none"> • at 60 V rated value 	3.5 A
<ul style="list-style-type: none"> • at 110 V rated value 	1.3 A
<ul style="list-style-type: none"> • at 220 V rated value 	0.9 A
<ul style="list-style-type: none"> • at 440 V rated value 	0.2 A
<ul style="list-style-type: none"> • at 600 V rated value 	0.1 A
Operating current with 3 current paths in series at DC-13	
<ul style="list-style-type: none"> • at 24 V rated value 	10 A
<ul style="list-style-type: none"> • at 60 V rated value 	4.7 A
<ul style="list-style-type: none"> • at 110 V rated value 	3 A
<ul style="list-style-type: none"> • at 220 V rated value 	1.2 A
<ul style="list-style-type: none"> • at 440 V rated value 	0.5 A
<ul style="list-style-type: none"> • at 600 V rated value 	0.26 A
Operating frequency at DC-13 maximum	1 000 1/h
Design of the miniature circuit breaker	

<ul style="list-style-type: none"> for short-circuit protection of the auxiliary circuit up to 230 V 	C characteristic: 6 A; 0.4 kA
Contact reliability of auxiliary contacts	1 faulty switching per 100 million (17 V, 1 mA)
UL/CSA ratings	
Contact rating of auxiliary contacts according to UL	A600 / Q600
Short-circuit protection	
Design of the fuse link <ul style="list-style-type: none"> for short-circuit protection of the auxiliary switch required 	fuse gL/gG: 10 A
Installation/ mounting/ dimensions	
Mounting position	+/-180° rotation possible on vertical mounting surface; can be tilted forward and backward by +/- 22.5° on vertical mounting surface
Mounting type	screw and snap-on mounting onto 35 mm standard mounting rail
Height	57.5 mm
Width	45 mm
Depth	73 mm
Required spacing <ul style="list-style-type: none"> with side-by-side mounting <ul style="list-style-type: none"> — forwards 10 mm — upwards 10 mm — downwards 10 mm — at the side 0 mm for grounded parts <ul style="list-style-type: none"> — forwards 10 mm — upwards 10 mm — at the side 6 mm — downwards 10 mm for live parts <ul style="list-style-type: none"> — forwards 10 mm — upwards 10 mm — downwards 10 mm — at the side 6 mm 	
Connections/Terminals	
Type of electrical connection <ul style="list-style-type: none"> for auxiliary and control current circuit 	screw-type terminals
Type of connectable conductor cross-sections <ul style="list-style-type: none"> for auxiliary contacts <ul style="list-style-type: none"> — single or multi-stranded 2x (0,5 ... 1,5 mm²), 2x (0,75 ... 2,5 mm²), 2x 4 mm² — finely stranded with core end processing 2x (0.5 ... 1.5 mm²), 2x (0.75 ... 2.5 mm²) at AWG conductors for auxiliary contacts 2x (20 ... 16), 2x (18 ... 14), 2x 12 	

Safety related data

B10 value	
<ul style="list-style-type: none"> with high demand rate acc. to SN 31920 	1 000 000; With 0.3 x Ie
Proportion of dangerous failures	
<ul style="list-style-type: none"> with low demand rate acc. to SN 31920 with high demand rate acc. to SN 31920 	40 % 73 %
Failure rate [FIT]	
<ul style="list-style-type: none"> with low demand rate acc. to SN 31920 	100 FIT
Product function	
<ul style="list-style-type: none"> positively driven operation acc. to IEC 60947-5-1 	Yes
T1 value for proof test interval or service life acc. to IEC 61508	20 y

Certificates/approvals

General Product Approval		Functional Safety/Safety of Machinery
 CCC	 CSA	 UL
		 EAC
		KC Type Examination Certificate
Declaration of Conformity	Test Certificates	Marine / Shipping
 EG-Konf.	Miscellaneous Type Test Certificates/Test Report	 ABS
		 BUREAU VERITAS
		 LRS
Marine / Shipping	other	
 PRS	 RINA	 RMRS
	 TYPE-APPROVED PRODUCT DNV-GL DNVGL.COM/AF	Confirmation  VDE

Further information

Information- and Downloadcenter (Catalogs, Brochures,...)

<http://www.siemens.com/industrial-controls/catalogs>

Industry Mall (Online ordering system)

<https://mall.industry.siemens.com/mall/en/en/Catalog/product?mlfb=3RH2122-1JB40>

Cax online generator

<http://support.automation.siemens.com/WW/CAXorder/default.aspx?lang=en&mlfb=3RH2122-1JB40>

Service&Support (Manuals, Certificates, Characteristics, FAQs,...)

<https://support.industry.siemens.com/cs/ww/en/ps/3RH2122-1JB40>

Image database (product images, 2D dimension drawings, 3D models, device circuit diagrams, EPLAN macros, ...)
http://www.automation.siemens.com/bilddb/cax_de.aspx?mlfb=3RH2122-1JB40&lang=en

Characteristic: Tripping characteristics, I^2t , Let-through current
<https://support.industry.siemens.com/cs/ww/en/ps/3RH2122-1JB40/char>

Further characteristics (e.g. electrical endurance, switching frequency)
<http://www.automation.siemens.com/bilddb/index.aspx?view=Search&mlfb=3RH2122-1JB40&objecttype=14&gridview=view1>

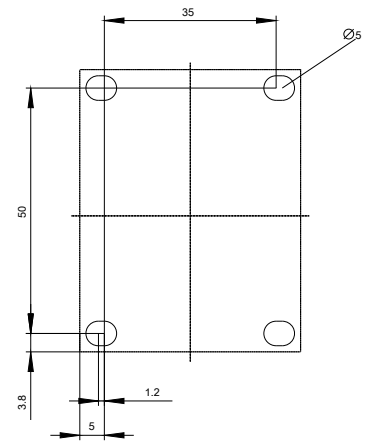
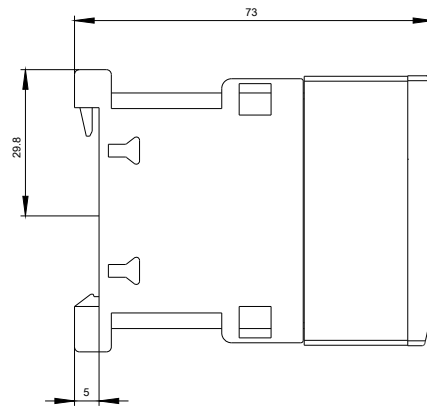
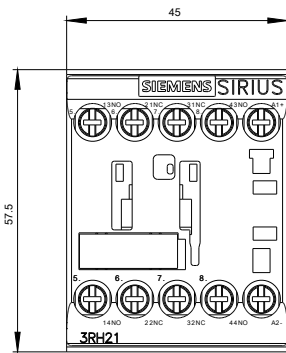

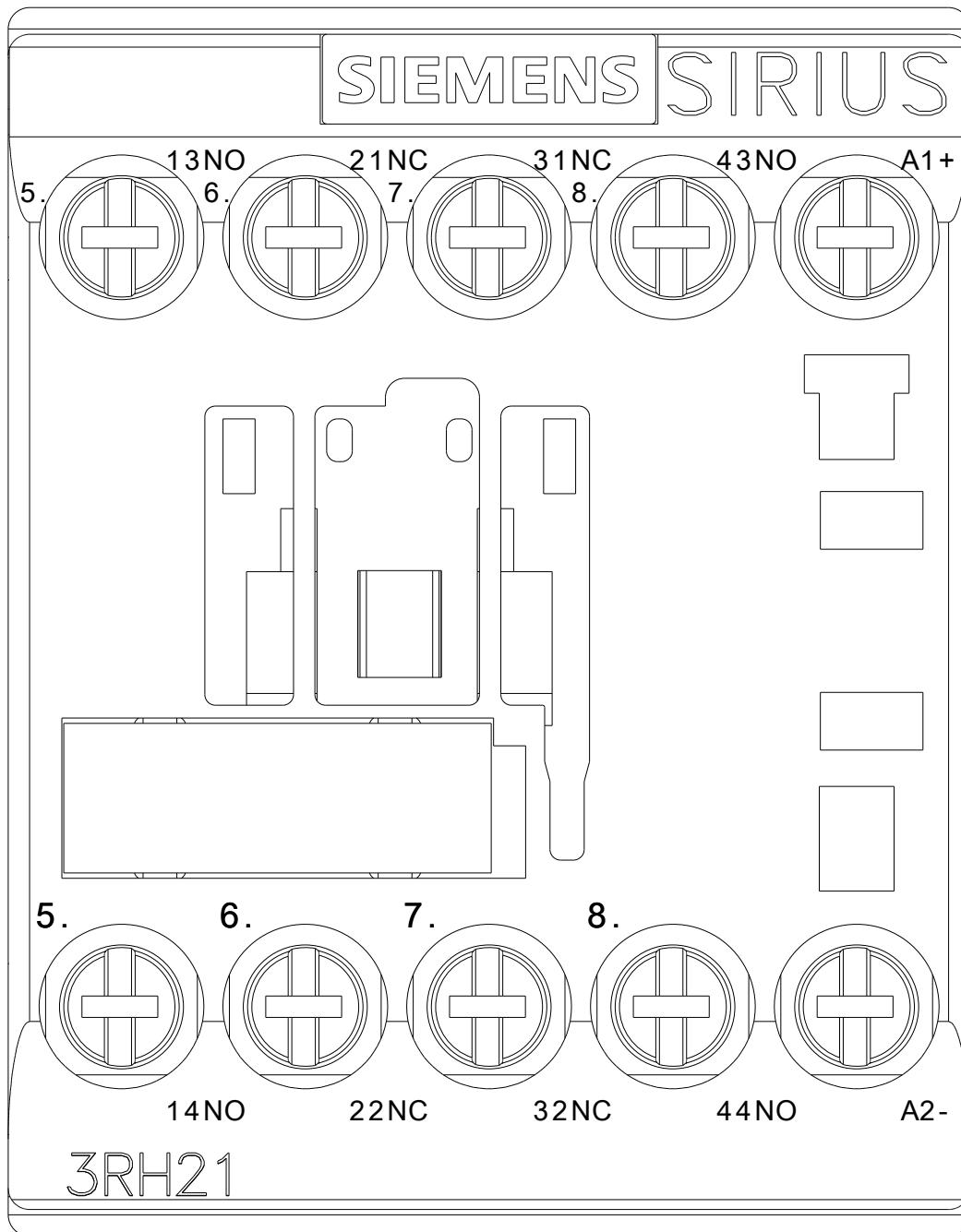

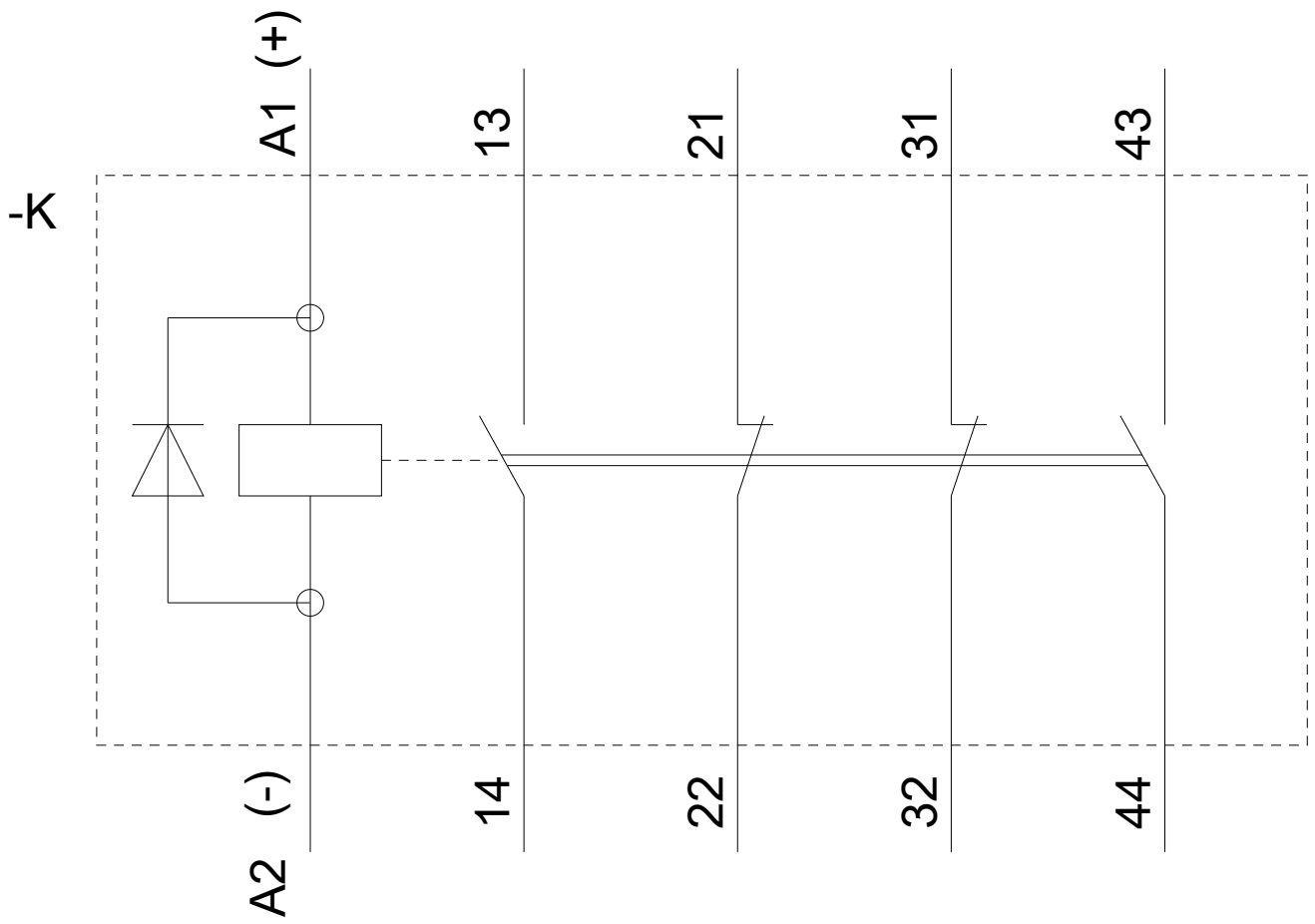

last modified:

06/07/2019