

Link module Electrical and mechanical for 3RV2.3 and 3RT2.3. (multi-unit packaging)

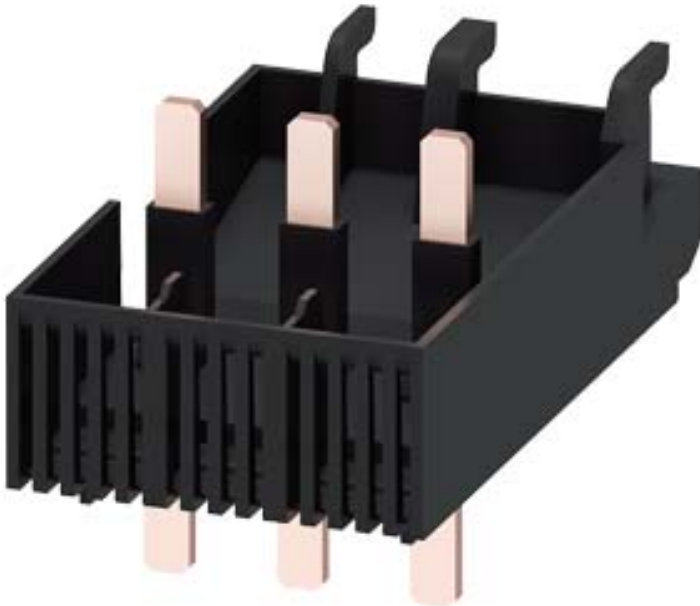





General technical data

Product brand name		SIRIUS
Product designation		link module
Size of the circuit-breaker		S2
Size of contactor		S2
Product component bottom wiring module		No
Product component top wiring module		No

Installation/ mounting/ dimensions

Mounting type		screw fixing
---------------	--	--------------

Certificates/approvals

General Product Approval		Declaration of Conformity		Test Certificates
 CSA	 UL		 EG-Konf.	Miscellaneous Type Test Certificates/Test Report

Test Certificates	Shipping Approval			other
Special Test Certificate	 ABS	 BUREAU VERITAS	 PRS	 RINA
				Confirmation

Further information

Information- and Downloadcenter (Catalogs, Brochures,...)

<http://www.siemens.com/industrial-controls/catalogs>

Industry Mall (Online ordering system)

<https://mall.industry.siemens.com/mall/en/en/Catalog/product?mlfb=3RA2931-1A>

Cax online generator

<http://support.automation.siemens.com/WW/CAXorder/default.aspx?lang=en&mlfb=3RA2931-1A>

Service&Support (Manuals, Certificates, Characteristics, FAQs,...)

<https://support.industry.siemens.com/cs/ww/en/ps/3RA2931-1A>

Image database (product images, 2D dimension drawings, 3D models, device circuit diagrams, EPLAN macros, ...)

http://www.automation.siemens.com/bilddb/cax_de.aspx?mlfb=3RA2931-1A&lang=en

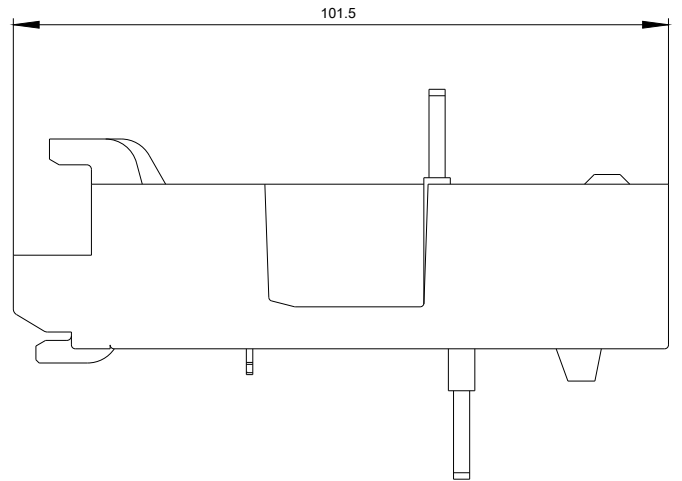
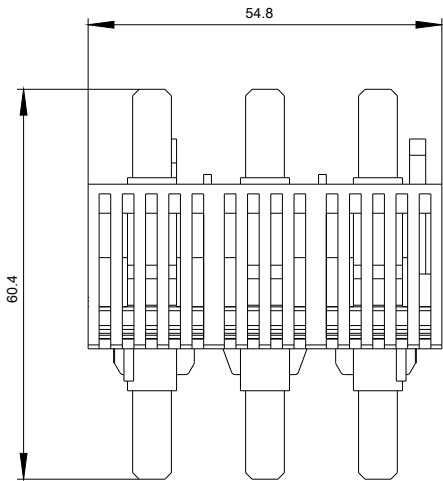

last modified:

02/18/2019