

Enclosure for command devices, 22 mm, round, Enclosure material plastic, enclosure top part gray, 1 control point plastic, Recess for label, without equipment



Product brand name	SIRIUS ACT
Product designation	Enclosures
Product type designation	3SU1

Enclosure	
Design of the housing	with recess for label
Shape of the enclosure front	Square
Material of the enclosure	plastic
Number of command points	1
Product component	
• protective collar	No
Color	
• of top part of the enclosure	grey
Mounting type of the enclosure	Vertical / horizontal

General technical data	
Protection class IP	IP66, IP67, IP69(IP69K)
Degree of protection NEMA rating	NEMA 1, 2, 3, 3R, 4, 4X, 12, 13
Shock resistance	
• for railway applications acc. to DIN EN 61373	Category 1, Class B
Vibration resistance	

• for railway applications acc. to DIN EN 61373	Category 1, Class B
Cable entry type	Without

Connections/ Terminals

Type of electrical connection on enclosure	Cable routing above and below, both 1 x M20
Tightening torque of mounting screws in the enclosure cover	1.5 ... 1.7 N·m







Ambient conditions

Ambient temperature	
• during operation	-25 ... +70 °C
• during storage	-40 ... +80 °C

Installation/ mounting/ dimensions

Mounting type	
• of modules and accessories	Floor mounting
Height	85 mm
Width	85 mm
Depth	64 mm
Mounting diameter	22.3 mm
Positive tolerance of installation diameter	0.4 mm



Certificates/ approvals

General Product Approval	Declaration of Conformity
 CCC  CSA  UL  VDE  EAC  EG-Konf.	

Declaration of Conformity	Test Certificates	Marine / Shipping
----------------------------------	--------------------------	--------------------------

Miscellaneous	Special Test Certificate	Type Test Certificates/Test Report	 ABS  LRS  PRS
-------------------------------	--	--	---

Marine / Shipping	other
--------------------------	--------------

 RINA  RMRS  DNV-GL <small>DNVGL.COM/AF</small>	Confirmation
---	------------------------------

Further information

Information- and Downloadcenter (Catalogs, Brochures,...)

www.siemens.com/sirius/catalogs

Industry Mall (Online ordering system)

<https://mall.industry.siemens.com/mall/en/en/Catalog/product?mfb=3SU1801-0AA00-0AB1>

Cax online generator

<http://support.automation.siemens.com/WW/CAXorder/default.aspx?lang=en&mfb=3SU1801-0AA00-0AB1>

Service&Support (Manuals, Certificates, Characteristics, FAQs,...)

<https://support.industry.siemens.com/cs/ww/en/ps/3SU1801-0AA00-0AB1>

Image database (product images, 2D dimension drawings, 3D models, device circuit diagrams, EPLAN macros, ...)

http://www.automation.siemens.com/bilddb/cax_de.aspx?mfb=3SU1801-0AA00-0AB1&lang=en

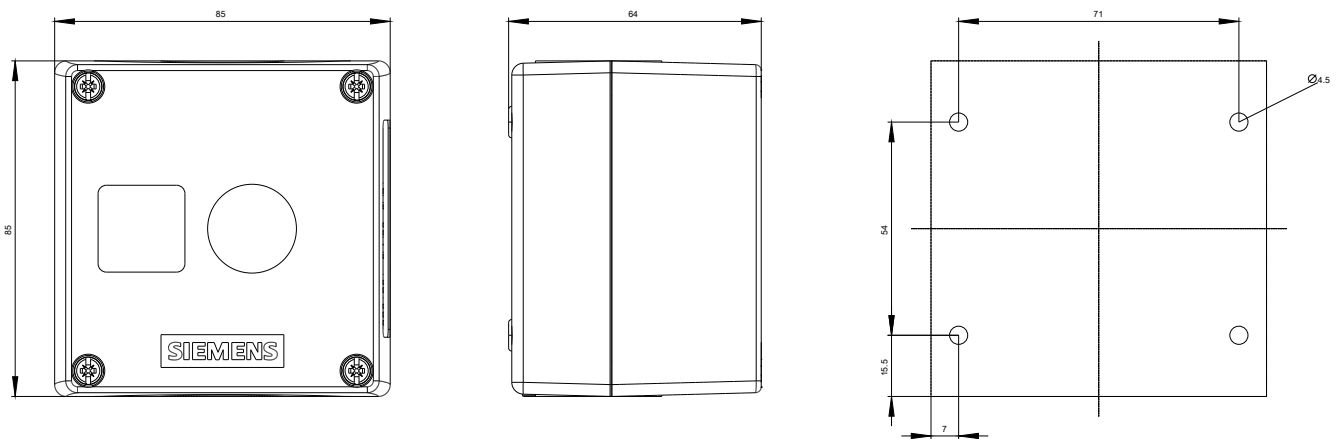

last modified:

10/02/2019