

Contactor relay, 2 NO + 2 NC, 600 V AC, 60 Hz, Size S00, screw terminal



Product brand name	SIRIUS
Product designation	Auxiliary contactor
Product type designation	3RH2
General technical data	
Size of contactor	S00
Product extension	
• Auxiliary switch	Yes
Insulation voltage	
• with degree of pollution 3 at AC rated value	690 V
Degree of pollution	3
Surge voltage resistance rated value	6 kV
Protection class IP	
• on the front	IP20
Shock resistance at rectangular impulse	
• at AC	7,3g / 5 ms, 4,7g / 10 ms
Shock resistance with sine pulse	
• at AC	11,4g / 5 ms, 7,3g / 10 ms
Mechanical service life (switching cycles)	
• of contactor typical	30 000 000

<ul style="list-style-type: none"> • of the contactor with added electronics-compatible auxiliary switch block typical 	5 000 000
<ul style="list-style-type: none"> • of the contactor with added auxiliary switch block typical 	10 000 000
Reference code acc. to DIN EN 81346-2	K
Reference code acc. to DIN EN 61346-2	K

Ambient conditions

Installation altitude at height above sea level	
<ul style="list-style-type: none"> • maximum 	2 000 m
Ambient temperature	
<ul style="list-style-type: none"> • during operation 	-25 ... +60 °C
<ul style="list-style-type: none"> • during storage 	-55 ... +80 °C

Main circuit

No-load switching frequency	
<ul style="list-style-type: none"> • at AC 	10 000 1/h
<ul style="list-style-type: none"> • at DC 	10 000 1/h

Control circuit/ Control

Type of voltage of the control supply voltage	AC
Control supply voltage at AC	
<ul style="list-style-type: none"> • at 60 Hz rated value 	600 V
Control supply voltage frequency	
<ul style="list-style-type: none"> • 2 rated value 	60 Hz
Operating range factor control supply voltage rated value of magnet coil at AC	
<ul style="list-style-type: none"> • at 60 Hz 	0.85 ... 1.1
Apparent pick-up power of magnet coil at AC	37 V·A
Inductive power factor with closing power of the coil	0.8
Apparent holding power of magnet coil at AC	5.7 V·A
Inductive power factor with the holding power of the coil	0.25
Closing delay	
<ul style="list-style-type: none"> • at AC 	8 ... 33 ms
Opening delay	
<ul style="list-style-type: none"> • at AC 	4 ... 15 ms
Arcing time	10 ... 15 ms

Auxiliary circuit

Number of NC contacts for auxiliary contacts	2
<ul style="list-style-type: none"> • instantaneous contact 	2
Number of NO contacts for auxiliary contacts	2
<ul style="list-style-type: none"> • instantaneous contact 	2
Identification number and letter for switching elements	22 E

Operating current at AC-12 maximum	10 A
Operating current at AC-15	
• at 230 V rated value	10 A
• at 400 V rated value	3 A
• at 500 V rated value	2 A
• at 690 V rated value	1 A
Operating current at 1 current path at DC-12	
• at 24 V rated value	10 A
• at 110 V rated value	3 A
• at 220 V rated value	1 A
• at 440 V rated value	0.3 A
• at 600 V rated value	0.15 A
Operating current with 2 current paths in series at DC-12	
• at 24 V rated value	10 A
• at 60 V rated value	10 A
• at 110 V rated value	4 A
• at 220 V rated value	2 A
• at 440 V rated value	1.3 A
• at 600 V rated value	0.65 A
Operating current with 3 current paths in series at DC-12	
• at 24 V rated value	10 A
• at 60 V rated value	10 A
• at 110 V rated value	10 A
• at 220 V rated value	3.6 A
• at 440 V rated value	2.5 A
• at 600 V rated value	1.8 A
Operating frequency at DC-12 maximum	1 000 1/h
Operating current at 1 current path at DC-13	
• at 24 V rated value	10 A
• at 110 V rated value	1 A
• at 220 V rated value	0.3 A
• at 440 V rated value	0.14 A
• at 600 V rated value	0.1 A
Operating current with 2 current paths in series at DC-13	
• at 24 V rated value	10 A
• at 60 V rated value	3.5 A
• at 110 V rated value	1.3 A
• at 220 V rated value	0.9 A
• at 440 V rated value	0.2 A

<ul style="list-style-type: none"> • at 600 V rated value 	0.1 A
Operating current with 3 current paths in series at DC-13	
<ul style="list-style-type: none"> • at 24 V rated value • at 60 V rated value • at 110 V rated value • at 220 V rated value • at 440 V rated value • at 600 V rated value 	10 A 4.7 A 3 A 1.2 A 0.5 A 0.26 A
Operating frequency at DC-13 maximum	1 000 1/h
Design of the miniature circuit breaker	
<ul style="list-style-type: none"> • for short-circuit protection of the auxiliary circuit up to 230 V 	C characteristic: 6 A; 0.4 kA
Contact reliability of auxiliary contacts	1 faulty switching per 100 million (17 V, 1 mA)

UL/CSA ratings

Contact rating of auxiliary contacts according to UL	A600 / Q600
---	-------------

Short-circuit protection

Design of the fuse link	
<ul style="list-style-type: none"> • for short-circuit protection of the auxiliary switch required 	fuse gL/gG: 10 A

Installation/ mounting/ dimensions

Mounting position	+/-180° rotation possible on vertical mounting surface; can be tilted forward and backward by +/- 22.5° on vertical mounting surface
Mounting type	screw and snap-on mounting onto 35 mm standard mounting rail
Height	57.5 mm
Width	45 mm
Depth	73 mm
Required spacing	
<ul style="list-style-type: none"> • with side-by-side mounting <ul style="list-style-type: none"> — forwards — upwards — downwards — at the side • for grounded parts <ul style="list-style-type: none"> — forwards — upwards — at the side — downwards • for live parts <ul style="list-style-type: none"> — forwards — upwards 	10 mm 10 mm 10 mm 0 mm 10 mm 10 mm 6 mm 10 mm 10 mm 10 mm

- downwards
- at the side

10 mm
6 mm

Connections/ Terminals

Type of electrical connection	
<ul style="list-style-type: none"> • for auxiliary and control current circuit 	screw-type terminals
Type of connectable conductor cross-sections	
<ul style="list-style-type: none"> • for auxiliary contacts <ul style="list-style-type: none"> — single or multi-stranded — finely stranded with core end processing • at AWG conductors for auxiliary contacts 	2x (0,5 ... 1,5 mm ²), 2x (0,75 ... 2,5 mm ²), 2x 4 mm ² 2x (0.5 ... 1.5 mm ²), 2x (0.75 ... 2.5 mm ²) 2x (20 ... 16), 2x (18 ... 14), 2x 12

Safety related data

B10 value	
<ul style="list-style-type: none"> • with high demand rate acc. to SN 31920 	1 000 000; With 0.3 x I _e
Proportion of dangerous failures	
<ul style="list-style-type: none"> • with low demand rate acc. to SN 31920 • with high demand rate acc. to SN 31920 	40 % 73 %
Failure rate [FIT]	
<ul style="list-style-type: none"> • with low demand rate acc. to SN 31920 	100 FIT
Product function	
<ul style="list-style-type: none"> • positively driven operation acc. to IEC 60947-5-1 	Yes
T1 value for proof test interval or service life acc. to IEC 61508	20 y

Certificates/ approvals

General Product Approval	EMC
--------------------------	-----



[KC](#)



Functional Safety/Safety of Machinery	Declaration of Conformity	Test Certificates	Marine / Shipping
---------------------------------------	---------------------------	-------------------	-------------------

[Type Examination Certificate](#)



[Miscellaneous](#)

[Type Test Certificates/Test Report](#)

[Special Test Certificate](#)



Marine / Shipping



other

[Confirmation](#)



Further information

Information- and Downloadcenter (Catalogs, Brochures,...)

www.siemens.com/ic10

Industry Mall (Online ordering system)

<https://mall.industry.siemens.com/mall/en/en/Catalog/product?mlfb=3RH2122-1AT60>

Cax online generator

<http://support.automation.siemens.com/WW/CAXorder/default.aspx?lang=en&mlfb=3RH2122-1AT60>

Service&Support (Manuals, Certificates, Characteristics, FAQs,...)

<https://support.industry.siemens.com/cs/ww/en/ps/3RH2122-1AT60>

Image database (product images, 2D dimension drawings, 3D models, device circuit diagrams, EPLAN macros, ...)

http://www.automation.siemens.com/bilddb/cax_de.aspx?mlfb=3RH2122-1AT60&lang=en

Characteristic: Tripping characteristics, I²t, Let-through current

<https://support.industry.siemens.com/cs/ww/en/ps/3RH2122-1AT60/char>

Further characteristics (e.g. electrical endurance, switching frequency)

<http://www.automation.siemens.com/bilddb/index.aspx?view=Search&mlfb=3RH2122-1AT60&objecttype=14&gridview=view1>

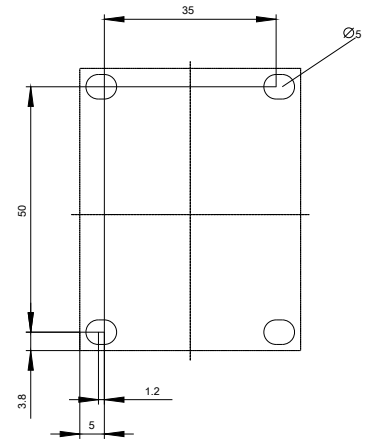
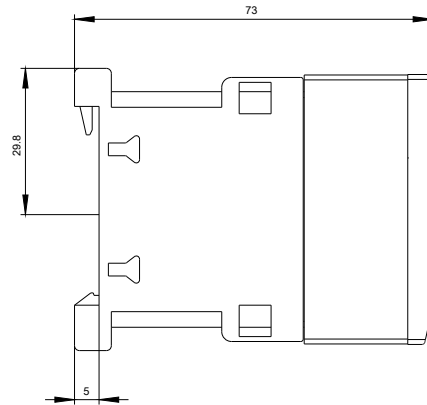
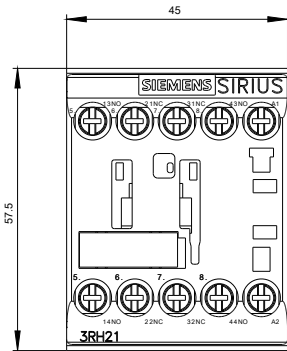





last modified:

12/20/2019