

SIRIUS motor starter M200D communication module
 PROFIBUS DP removable Bus connection 2 x M12 with
 loop-through Power connection 24 V 2 x 7/8" with loop-
 through Bus terminating resistor integrated via
 technology module 3RK1395* can be used as Motor
 starter M200D with communication



General technical data:

Product brand name		SIRIUS
Product designation		Communication module
Design of the product		communication module
Product function Bus communication		Yes
Surge voltage resistance rated value	V	800
Insulation voltage rated value	V	30
Reference code acc. to DIN EN 61346-2		Q
Mounting type		screw fixing
Width	mm	174
Height	mm	139
Depth	mm	32

Control circuit/ Control:

Type of voltage of the control supply voltage		DC
Control supply voltage 1		
• at DC rated value	V	24

Supply voltage:

Type of voltage of the supply voltage		DC
---------------------------------------	--	----

Supply voltage		
• at DC rated value	V	24
• at DC rated value minimum permissible	V	20.4
• at DC rated value maximum permissible	V	28.8

Ambient conditions:

Protection class IP		IP65
Ambient temperature		
• during storage	°C	-40 ... +70
• during operation	°C	-25 ... +55
• during transport	°C	-40 ... +70
Relative humidity during operation	%	10 ... 95
Vibration resistance		7 mm / 2g
Shock resistance		12g / 11 ms
Degree of pollution		3
Installation altitude at height above sea level maximum	m	2 000
Mounting position		vertical, horizontal, flat
Mounting position recommended		horizontal

Communication/ Protocol:

Design of the interface AS-interface protocol		No
Protocol is supported AS-interface protocol		No
Design of the interface PROFIBUS DP protocol		Yes
Protocol is supported PROFIBUS DP protocol		Yes
Product function		
• Control circuit interface with IO link		No
• Control circuit interface to parallel wiring		No
Protocol is supported PROFINET protocol		No
Type of electrical connection of the communication interface		M12 plug

Connections/ Terminals:





Type of electrical connection		
• for communication transmission		M12 socket
• for auxiliary and control current circuit		connector

Electromagnetic compatibility:

EMI immunity acc. to IEC 60947-1		corresponds to degree of severity 3, ambience A (industrial sector)
Conducted interference due to burst acc. to IEC 61000-4-4		2 kV network connection / 1 kV control connection
Conducted interference due to conductor-earth surge acc. to IEC 61000-4-5		2 kV
Conducted interference due to conductor-conductor surge acc. to IEC 61000-4-5		1 kV

EMC emitted interference acc. to IEC 60947-1	CISPR11, ambience A (industrial sector)
Certificate of suitability	CE

Certificates/ approvals:

General Product Approval	EMC	Declaration of Conformity
 CSA  UL	 EAC  RCM	 EG-Konf. Miscellaneous

Test Certificates	other
-------------------	-------

[Type Test Certificates/Test Report](#)

[Confirmation](#)



Profibus

Further information

Information- and Downloadcenter (Catalogs, Brochures,...)

<http://www.siemens.com/industrial-controls/catalogs>

Industry Mall (Online ordering system)

<http://www.siemens.com/industrymall>

Cax online generator

<http://support.automation.siemens.com/WW/CAXorder/default.aspx?lang=en&mlfb=3RK1305-0AS01-0AA0>

Service&Support (Manuals, Certificates, Characteristics, FAQs,...)

<https://support.industry.siemens.com/cs/ww/en/ps/3RK1305-0AS01-0AA0>

Image database (product images, 2D dimension drawings, 3D models, device circuit diagrams, EPLAN macros, ...)

http://www.automation.siemens.com/bilddb/cax_de.aspx?mlfb=3RK1305-0AS01-0AA0&lang=en

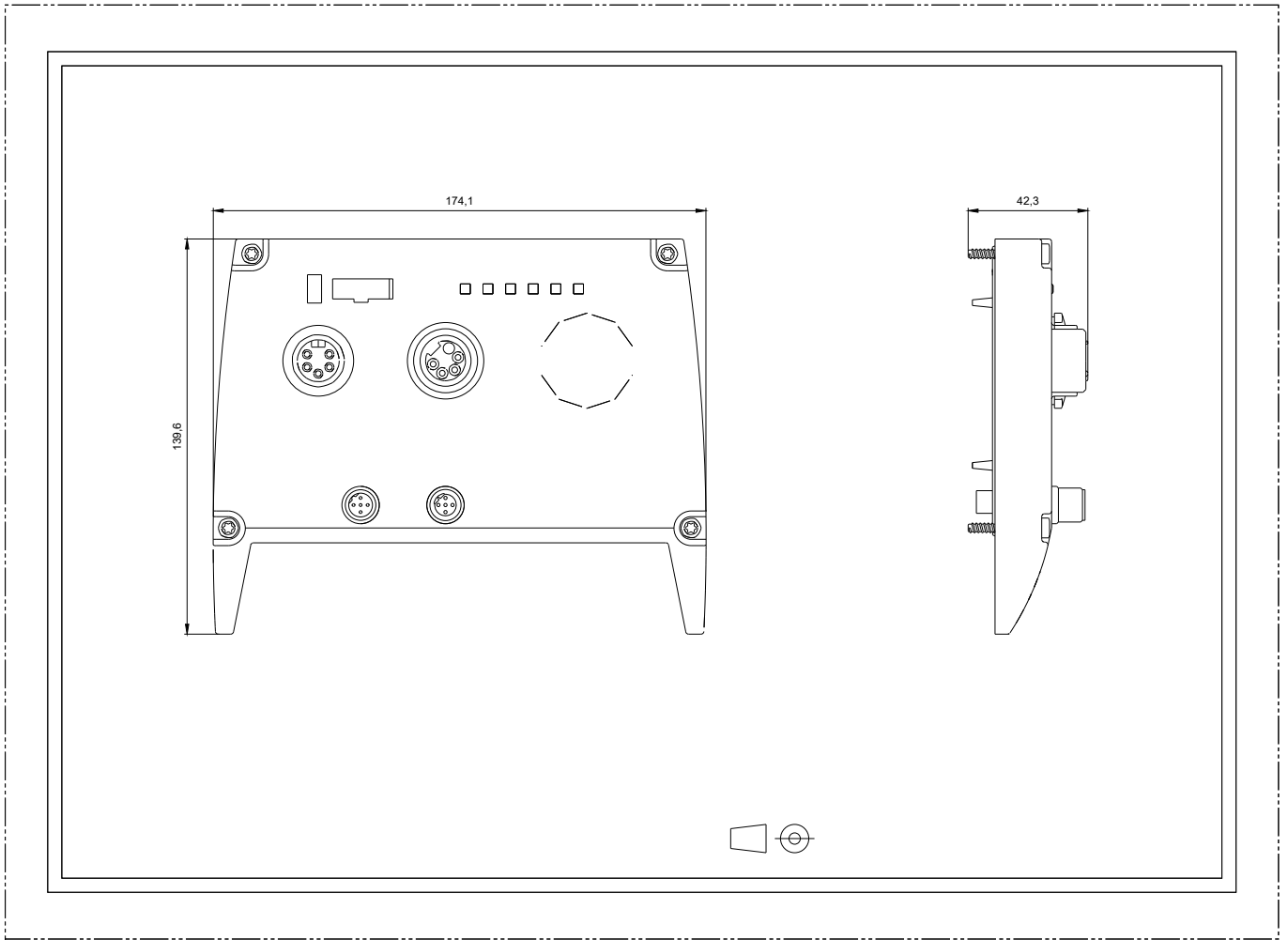

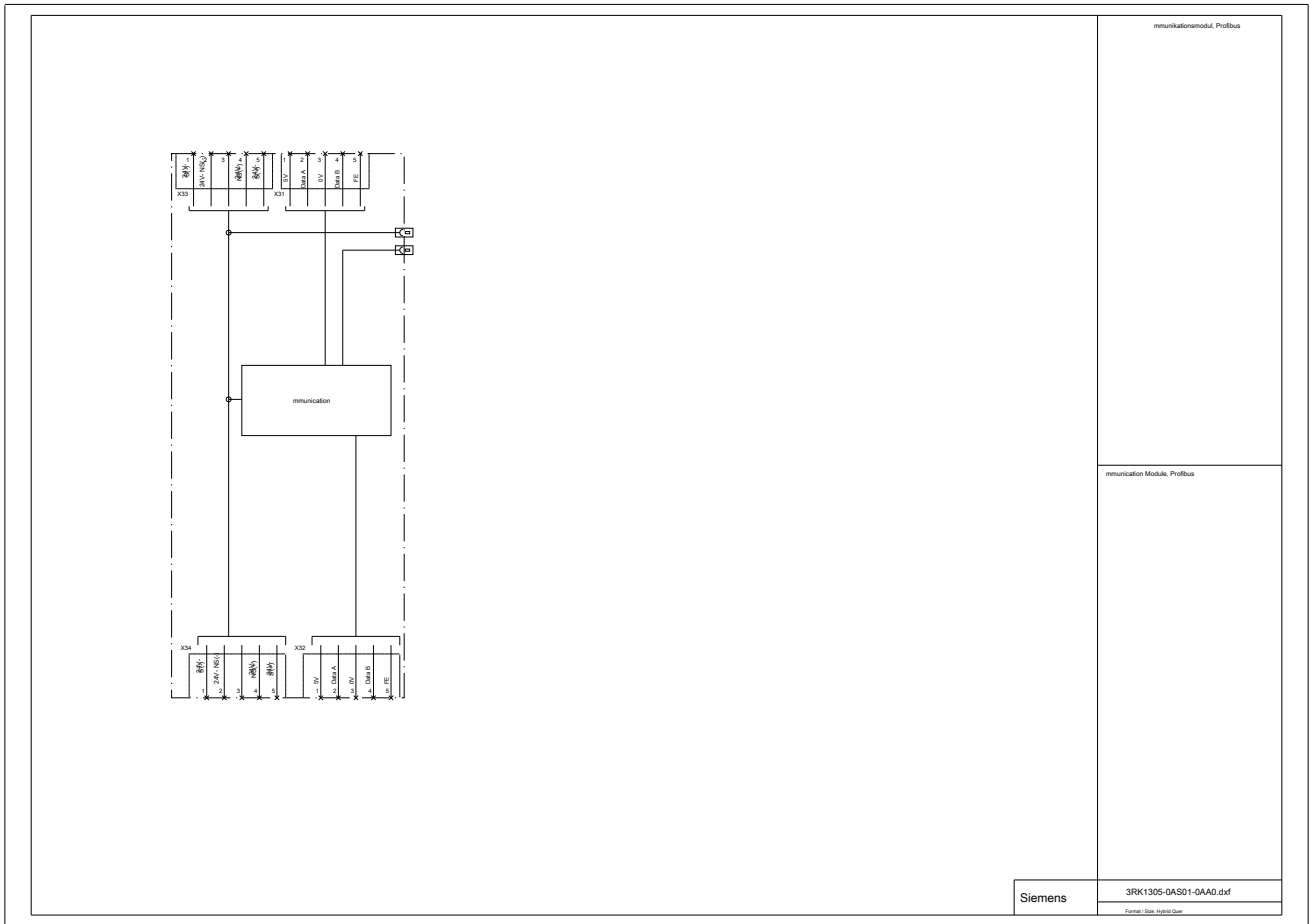

last modified:

09/13/2019