













RC element 48...127 V AC, 70...150 V DC Surge suppressor For mounting onto contactors Size S00 !!! Phased-out product !!! Successor is SIRIUS 3RT2 Preferred successor type is >>3RT2916-1CC00<<

Figure similar

product brand name	SIRIUS				
product designation	surge suppressor				
General technical data					
size of contactor	S00				
certificate of suitability	CE / UL / CSA				
Substance Prohibitance (Date)	07/01/2006				
type of voltage of the control supply voltage	AC/DC				
control supply voltage 1 at AC	48 ... 127 V				
• at 50 Hz	48 ... 127 V				
• at 60 Hz	48 ... 127 V				
control supply voltage frequency	50 Hz				
• 1 rated value	60 Hz				
• 2 rated value	60 Hz				
control supply voltage 1	70 ... 150 V				
• at DC	70 ... 150 V				
design of the surge suppressor	RC element				
Ambient conditions					
ambient temperature	-25 ... +60 °C				
• during operation	-40 ... +80 °C				
• during storage	-40 ... +80 °C				
Approvals Certificates					
General Product Approval	EMC	Declaration of Conformity			
 CSA	Confirmation	 UR	 EAC	 RCM	 UK CA
Declaration of Conformity	Test Certificates	Marine / Shipping			
 EG-Konf.	Special Test Certificate	 ABS	 PRS	 RINA	 DNV-GL
other	Railway				

**Further information**

Siemens has decided to exit the Russian market (see here).

<https://press.siemens.com/global/en/pressrelease/siemens-wind-down-russian-business>

Siemens is working on the renewal of the current EAC certificates.

Please contact your local Siemens office on the status of validity of the EAC certification if you intend to import or offer to supply these products to an EAC relevant market (other than the sanctioned EAEU member states Russia or Belarus).

Information on the packaging

<https://support.industry.siemens.com/cs/ww/en/view/109813875>

Information- and Downloadcenter (Catalogs, Brochures,...)

<https://www.siemens.com/ic10>

Industry Mall (Online ordering system)

<https://mall.industry.siemens.com/mall/en/en/Catalog/product?mlfb=3RT1916-1CC00>

Cax online generator

<http://support.automation.siemens.com/WW/CAXorder/default.aspx?lang=en&mlfb=3RT1916-1CC00>

Service&Support (Manuals, Certificates, Characteristics, FAQs,...)

<https://support.industry.siemens.com/cs/ww/en/ps/3RT1916-1CC00>

Image database (product images, 2D dimension drawings, 3D models, device circuit diagrams, EPLAN macros, ...)

http://www.automation.siemens.com/bilddb/cax_de.aspx?mlfb=3RT1916-1CC00&lang=en

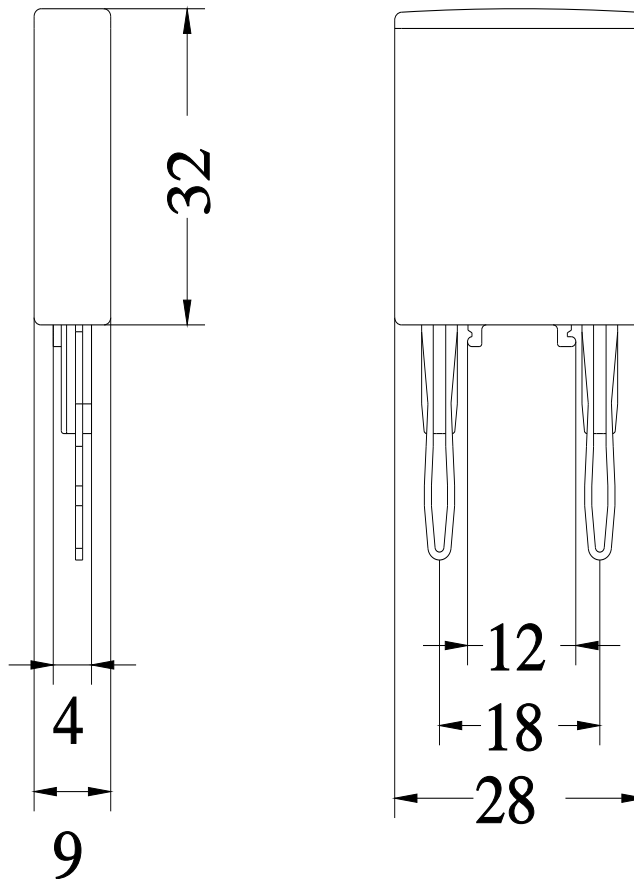

last modified:

10/22/2022