

SIEMENS



Communication Manual

SENTRON

3VA Molded Case Circuit Breakers

with IEC- and UL-Certification

Edition

08/2017

www.siemens.com/3VA

SIEMENS

SENTRON

Protection devices 3VA IEC/UL molded case circuit breaker communication

System Manual

<u>Introduction</u>	1
<u>System description</u>	2
<u>Functions</u>	3
<u>Application examples</u>	4
<u>Connection, commissioning, operation</u>	5
<u>Addressing via Modbus</u>	6
<u>Commissioning and service software: powerconfig</u>	7
<u>Service and maintenance</u>	8
<u>Appendix</u>	A

Legal information

Warning notice system

This manual contains notices you have to observe in order to ensure your personal safety, as well as to prevent damage to property. The notices referring to your personal safety are highlighted in the manual by a safety alert symbol, notices referring only to property damage have no safety alert symbol. These notices shown below are graded according to the degree of danger.

DANGER

indicates that death or severe personal injury **will** result if proper precautions are not taken.

WARNING

indicates that death or severe personal injury **may** result if proper precautions are not taken.

CAUTION

indicates that minor personal injury can result if proper precautions are not taken.

NOTICE

indicates that property damage can result if proper precautions are not taken.

If more than one degree of danger is present, the warning notice representing the highest degree of danger will be used. A notice warning of injury to persons with a safety alert symbol may also include a warning relating to property damage.

Qualified Personnel

The product/system described in this documentation may be operated only by **personnel qualified** for the specific task in accordance with the relevant documentation, in particular its warning notices and safety instructions. Qualified personnel are those who, based on their training and experience, are capable of identifying risks and avoiding potential hazards when working with these products/systems.

Proper use of Siemens products

Note the following:

WARNING

Siemens products may only be used for the applications described in the catalog and in the relevant technical documentation. If products and components from other manufacturers are used, these must be recommended or approved by Siemens. Proper transport, storage, installation, assembly, commissioning, operation and maintenance are required to ensure that the products operate safely and without any problems. The permissible ambient conditions must be complied with. The information in the relevant documentation must be observed.

Trademarks

All names identified by ® are registered trademarks of Siemens AG. The remaining trademarks in this publication may be trademarks whose use by third parties for their own purposes could violate the rights of the owner.

Disclaimer of Liability

We have reviewed the contents of this publication to ensure consistency with the hardware and software described. Since variance cannot be precluded entirely, we cannot guarantee full consistency. However, the information in this publication is reviewed regularly and any necessary corrections are included in subsequent editions.

Table of contents

1	Introduction	11
1.1	Security information	15
1.2	Open Source Software	16
2	System description	17
2.1	Communication system of the 3VA molded case circuit breaker	18
2.2	Access to the 3VA molded case circuit breaker via TD500.....	20
2.3	Information security.....	21
2.4	COM800 / COM100 breaker data server.....	22
2.4.1	Area of application	23
2.4.2	Features.....	24
2.5	Communication with ETUs	25
2.5.1	Area of application	25
2.5.2	Features.....	26
2.6	EFB300 external function box.....	27
2.6.1	Area of application	27
2.6.2	Features.....	27
2.7	DSP800 display	28
2.7.1	Area of application	28
2.7.2	Features.....	29
2.8	TD500 test device	30
2.8.1	Area of application	30
2.8.2	Features.....	31
2.9	7KM PAC PROFIBUS DP expansion module	32
2.9.1	Area of application	32
2.9.2	Features.....	33
2.10	7KM PAC Switched Ethernet PROFINET expansion module	34
2.10.1	Area of application	35
2.10.2	Features.....	35
2.11	7KM PAC RS 485 expansion module for Modbus RTU	36
2.11.1	Area of application	36
2.11.2	Features.....	37
2.12	Commissioning and service software: powerconfig.....	38
2.12.1	Area of application	38
2.12.2	Features.....	39

3	Functions	41
3.1	Parameterizing 3VA molded case circuit breakers	42
3.2	Status of the molded case circuit breaker	44
3.2.1	Switching 3VA molded case circuit breakers	45
3.2.2	Switching state and accompanying information	46
3.2.3	Displaying draw-out status	50
3.3	Test functions	51
3.4	Acquiring and communicating measured variables	52
3.4.1	Current variables	54
3.4.2	Voltage variables	56
3.4.2.1	Voltage variables L-N	56
3.4.2.2	Voltage variables L-L	57
3.4.3	Measuring power	59
3.4.3.1	Active power	59
3.4.3.2	Reactive power	61
3.4.3.3	Apparent power	64
3.4.3.4	Power factors	65
3.4.4	Measuring energy	66
3.4.4.1	Energy variables	67
3.4.5	Evaluating the load profile	67
3.4.6	Measuring the frequency and harmonic content	68
3.4.6.1	Frequency variables	68
3.4.6.2	Harmonic content	68
3.5	Messages	72
3.6	Available database	73
3.6.1	Data formats and byte ordering	74
3.6.2	Data contents and register addresses	76
4	Application examples	91
4.1	Power monitoring with powermanager	95
4.1.1	Application	96
4.1.2	Multi-language capability	96
4.2	Automation technology	97
4.3	Building automation	100
5	Connection, commissioning, operation	101
5.1	Application planning	101
5.1.1	Installation locations	101
5.1.2	Supply voltages and grounding system	104
5.1.3	Heat loss calculation of the communication components	105
5.1.4	Ambient conditions	105
5.1.5	Communication network planning	106

5.2	COM800 / COM100 breaker data server	107
5.2.1	Connecting	108
5.2.1.1	Connecting the 24 V supply	108
5.2.1.2	Connecting the 3VA-line	109
5.2.1.3	Ethernet connection	110
5.2.1.4	Connecting the module interface	111
5.2.2	Operator controls and displays	112
5.2.2.1	LED display	112
5.2.2.2	Write-protect switch	114
5.2.3	Commissioning	115
5.2.3.1	First commissioning	115
5.2.3.2	Configuring from the device library	116
5.2.3.3	Resetting	118
5.2.3.4	Commissioning a 3VA connected to COM800 / COM100	119
5.2.4	Operation	122
5.3	COM060 communication module and draw-out unit	124
5.3.1	Connecting	124
5.3.1.1	Connection of supply voltage	124
5.3.1.2	Connecting the 3VA-line	124
5.3.1.3	Connecting the T-connectors	124
5.3.2	Commissioning	124
5.3.2.1	First commissioning	124
5.3.2.2	Resetting	124
5.3.2.3	Commissioning with powerconfig	125
5.3.3	Operation	125
5.3.3.1	Position in draw-out unit	126
5.4	Communication with ETUs 5-series and 8-series	127
5.4.1	Connecting	127
5.4.1.1	Connection of supply voltage	127
5.4.1.2	Connecting the ETUs 5-series and 8-series for communication	127
5.4.2	Operator controls and displays	127
5.4.3	Commissioning	128
5.4.3.1	First commissioning	128
5.4.3.2	Resetting	128
5.4.3.3	Commissioning with powerconfig	128
5.4.3.4	Signaling the communication capability	130
5.4.4	Operation	130
5.5	EFB300 external function box	131
5.5.1	Connecting	131
5.5.1.1	Connecting the 24 V supply	131
5.5.1.2	Connection of the EFB300 external function box	132
5.5.2	Operator controls	133
5.5.2.1	Display elements and terminal assignments	133
5.5.3	Commissioning	135
5.5.3.1	First commissioning	135
5.5.3.2	Resetting	135
5.5.3.3	Commissioning with powerconfig	136
5.5.4	Operation	138

5.6	DSP800 display.....	139
5.6.1	Connecting.....	139
5.6.1.1	Connecting the 24 V supply.....	139
5.6.1.2	Connection to COM800 / COM100 via Ethernet.....	140
5.6.2	Operator controls.....	141
5.6.3	Display.....	142
5.6.4	Commissioning.....	143
5.6.4.1	First commissioning.....	143
5.6.4.2	Resetting.....	144
5.6.4.3	Commissioning with powerconfig.....	145
5.6.5	Operation.....	146
5.6.5.1	Home menu.....	146
5.6.5.2	Navigation in the DSP800.....	147
5.7	TD500 test device.....	148
5.7.1	Connecting.....	148
5.7.1.1	PC connection.....	149
5.7.2	Operator controls.....	150
5.7.2.1	LED displays.....	151
5.7.3	Commissioning.....	152
5.7.3.1	First commissioning.....	152
5.7.3.2	Resetting.....	152
5.7.4	Operation.....	153
5.7.4.1	Execute a test with TD500.....	153
5.7.4.2	Test with TD500 and powerconfig.....	153
5.7.4.3	Evaluate tests with powerconfig.....	154
5.8	PROFIBUS DP expansion module.....	155
5.8.1	Connecting.....	155
5.8.1.1	Connecting the 24 V supply.....	155
5.8.1.2	Connecting PROFIBUS DP.....	155
5.8.2	Operator controls.....	158
5.8.2.1	LED display.....	158
5.8.3	Commissioning.....	159
5.8.3.1	First commissioning.....	159
5.8.3.2	Resetting.....	160
5.8.3.3	Commissioning.....	161
5.8.3.4	PROFIBUS DP.....	163
5.8.4	Operation.....	164
5.8.4.1	Cyclic communication via PROFIBUS DP.....	164
5.8.4.2	Acyclic communication via PROFIBUS DP.....	170
5.8.4.3	Access to all data.....	173
5.8.4.4	Interrupt and diagnosis concept with PROFIBUS DP.....	173

5.9	Switched Ethernet PROFINET expansion module	177
5.9.1	Connecting	177
5.9.1.1	Connecting the 24 V supply	177
5.9.1.2	Connecting Switched Ethernet PROFINET	177
5.9.2	Operator controls	179
5.9.2.1	LED display	179
5.9.3	Commissioning	180
5.9.3.1	First commissioning	180
5.9.3.2	Resetting	181
5.9.3.3	Commissioning	182
5.9.3.4	PROFINET IO	184
5.9.4	Operation	186
5.9.4.1	Cyclic communication via PROFINET IO	186
5.9.4.2	PROFIenergy	192
5.9.4.3	Acyclic communication via PROFINET	195
5.9.4.4	Modbus TCP with the Switched Ethernet PROFINET expansion module	195
5.10	RS 485 expansion module	195
5.10.1	Connection	195
5.10.1.1	Connection of 24 V supply	195
5.10.1.2	Connection of the 7KM PAC RS 485 expansion module	196
5.10.2	Commissioning	200
5.10.2.1	First commissioning	200
5.10.2.2	Resetting	201
5.10.2.3	Commissioning	202
5.10.3	Operation	203
6	Addressing via Modbus	205
6.1	Addressing in the COM800 / COM100 breaker data server	205
6.2	Communication via Modbus	206
6.2.1	Addressing via Modbus TCP	206
6.2.2	Establishing a connection for Modbus TCP	207
6.3	Addressing via Modbus RTU	208
7	Commissioning and service software: powerconfig	211
7.1	Description	211
7.1.1	Delivery	212
7.1.2	System requirements	212
7.1.3	PC network settings	213
7.2	User interface	217
7.3	Application types	219
7.3.1	Project management	220
7.3.2	Parameterizing 3VA molded case circuit breakers	222
7.3.3	Testing 3VA molded case circuit breakers	223
7.3.4	Commissioning of 3VA molded case circuit breakers	224

7.4	Configuration with powerconfig.....	228
7.4.1	From planning to installation: Top-down.....	228
7.4.1.1	Import from SIMARIS design.....	228
7.4.1.2	Create the project from the device library.....	229
7.4.1.3	Setting the configuration parameters in the Parameters view.....	229
7.4.1.4	Communication with the devices.....	230
7.4.1.5	Searching for devices in the communication network.....	230
7.4.1.6	Download the parameters to the devices and check them.....	231
7.4.2	From installation to power monitoring: Bottom-up.....	232
7.4.2.1	Installation of the devices and communication channels (pre-installation).....	232
7.4.2.2	Searching for devices in the communication network.....	232
7.4.2.3	Transferring 3VA molded case circuit breakers into the powerconfig project.....	235
7.4.2.4	Transfer the device configuration and parameters to the powerconfig project.....	235
7.4.3	Commission the installation with powerconfig.....	236
7.4.4	Archiving and documenting the installation with powerconfig.....	236
7.4.5	Continuing to use results from powerconfig in powermanager.....	237
7.4.6	Maintaining an installation with powerconfig.....	238
7.5	IP addressing.....	238
7.5.1	IP addressing with fixed IP addresses.....	239
7.5.2	IP addressing via name.....	240
7.5.3	IP addressing from the Internet.....	242
8	Service and maintenance.....	245
8.1	Firmware update.....	245
8.2	Replacing the 3VA molded case circuit breaker connected to a COM800 / COM100.....	247
8.3	Understanding status transitions.....	251
8.4	What to do in the event of communication faults.....	253
8.4.1	Check communication between COM800 / COM100 breaker data server and external partner.....	253
8.4.2	Check communication between COM800 / COM100 breaker data server and 3VA molded case circuit breakers.....	255
8.4.3	Kommunikation zwischen externem Kommunikationspartner und 3VA prüfen.....	256
A	Appendix.....	257
A.1	Standards and specifications.....	257
A.1.1	3VA molded case circuit breaker.....	257
A.1.2	PROFIBUS / PROFINET expansion modules.....	258
A.1.3	Ethernet interface COM800 / COM100.....	258
A.2	List of abbreviations.....	259
A.3	Comprehensive support from A to Z.....	261
A.3.1	Comprehensive support from A to Z.....	261
A.4	References.....	263
A.4.1	References.....	263
	Glossary.....	265
	Index.....	275

Introduction

Users of power supply systems for industrial applications, infrastructure and buildings are setting ever higher standards of the flexibility, transparency and communication capability offered by these systems. Intelligent switching devices are networked via communication systems and play an important role in industrial production and building management.

The standards expected of molded case circuit breakers in terms of their electrical and mechanical properties, their adaptability and cost effectiveness coupled with the ongoing trends in favor of rationalization and automation have greatly accelerated advances in the design of molded case circuit breakers over recent years.

In order to allow continuous monitoring of installations and achieve optimum metering of power supply and consumption with efficient process integration, it is important to consider two factors, i.e. the design of the required measuring points and early planning of the power distribution components which need to be monitored.

The following information is important to this process:

- Structure of the power distribution system
- Components of the power supply system
- Position of components in the power distribution system
- Allocation of power demands according to planned usage scenarios

For different levels and power distribution components, it is important to take into account the measurements and signals/feedback required during operation as well as various other requirements with respect to:

- Critical areas of the process
- Availability of loads
- Billing data (plausibility, contract monitoring, cost center management)
- Transparency for operation (measured variables, status)
- Capacity utilization (current metering)

Content and target readers of this manual

This communication manual will help you to configure your installation in a systematic way and enable you to monitor it effectively. Example applications are used in order to explain proper usage of communication-capable 3VA molded case circuit breakers.

The manual is aimed at the following target readers:

- Persons involved in commissioning of the plant, such as
 - commissioning engineers
 - technicians
 - application programmers
- (System) commissioning engineers
- Service and maintenance personnel
- Plant operators including users of power monitoring software such as powermanager

Please note that only information technology aspects of 3VA molded case circuit breakers are described in this manual.

For information pertaining to electrical engineering, safety features, installation and other details, please refer to the following documents:

- Manual "3VA Molded Case Circuit Breakers with IEC Certification"
(<http://support.automation.siemens.com/WW/view/de/90318775/0/en>)
- Manual "3VA Molded Case Circuit Breakers with IEC and UL Certification"
(<https://support.industry.siemens.com/cs/ww/en/view/109749082>)
- Manual "7KM PAC PROFIBUS DP, 7KM PAC Switched Ethernet PROFINET Communication and Expansion Modules"
(<http://support.automation.siemens.com/WW/view/en/26504372>)
- Operating instructions for the IEC components:
 - COM800 / COM100 breaker data server
(<http://support.automation.siemens.com/WW/view/en/80601362>)
 - 3VA molded case circuit breakers with all ETUs
(<http://support.automation.siemens.com/WW/view/en/80595722>)
 - EFB300 external function box
(<http://support.automation.siemens.com/WW/view/en/80600828>)
 - COM060 communication module
(<http://support.automation.siemens.com/WW/view/en/80600984>)
 - RCD820 residual current devices
(<http://support.automation.siemens.com/WW/view/en/91495016>)
 - Draw-out unit (<https://support.industry.siemens.com/cs/ww/en/view/80597246>)
 - DSP800 display (<https://support.industry.siemens.com/cs/de/en/view/102393764>)
 - TD500 test device (<http://support.automation.siemens.com/WW/view/en/80600753>)

- Operating instructions for the UL components:
 - COM800 / COM100 breaker data server, UL (<https://support.industry.siemens.com/cs/ww/en/view/109742912>)
 - 3VA molded case circuit breakers with electronic trip units, 3-series, UL (<https://support.industry.siemens.com/cs/ww/en/view/109740265>)
 - 3VA molded case circuit breakers with electronic trip units, 5-series and 8-series, UL (<https://support.industry.siemens.com/cs/ww/en/view/109740267>)
 - EFB300 external function box, UL (<https://support.industry.siemens.com/cs/ww/en/view/109742911>)
 - COM060 communication module, UL (<https://support.industry.siemens.com/cs/ww/en/view/109742908>)
 - Draw-out unit, UL (<https://support.industry.siemens.com/cs/ww/en/view/109742931>)
 - DSP800 display, UL (<https://support.industry.siemens.com/cs/ww/en/view/109742915>)
 - TD500 test device, UL (<https://support.industry.siemens.com/cs/ww/en/view/109742905>)
- Operating instructions for 7KM PAC PROFIBUS DP, 7KM PAC Switched Ethernet PROFINET communication and expansion modules
- Operating instructions for the PAC PROFIBUS DPV1 expansion module (<https://support.industry.siemens.com/cs/ww/en/view/26504884>)
- Operating instructions for the SENTRON SWITCHED ETHERNET PROFINET module (<https://support.industry.siemens.com/cs/ww/en/view/49742527>)
- Documentation "Quick Start" (<https://support.industry.siemens.com/cs/ww/en/view/92189166>) with instructions on how to use the energy management software powermanager
- Online help of powerconfig

In the system manual "3VA Molded Case Circuit Breaker Communication", the components are regarded merely as data suppliers or command receivers.

The documents are available under the link to the 3VA documentation (<https://support.industry.siemens.com/cs/ww/en/ps/19479>).

Structure of the manual

The manual is divided into the following chapters:

- Chapter 2 - System description (Page 17)
This chapter presents an overview of the components of the communication system of 3VA molded case circuit breakers.
- Chapter 3 - Functions (Page 41)
This chapter explains the functionality and data provided by 3VA molded case circuit breakers.
- Chapter 4 - Example applications (Page 91)
This chapter presents possible applications for 3VA molded case circuit breakers.
- Chapter 5 - Connection, commissioning, operation (Page 101)
This chapter describes how individual components can be used and configured to operate with other components.
- Chapter 6 - Addressing via Modbus (Page 205)
Addressing of the 3VA molded case circuit breakers via COM800 / COM100 breaker data servers is explained in this chapter. Addressing via Modbus TCP and Modbus RTU is also described.
- Chapter 7 - Commissioning and service software: powerconfig (Page 211)
Describes the handling and procedure for powerconfig.
- Chapter 8 - Servicing and maintenance (Page 245)
Information on how to update the firmware, replace communication-capable 3VA molded case circuit breakers and handle exceptional situations is provided in this chapter.

Navigation around the manual

The following guides to accessing information are provided:

- Table of contents
- Section "Structure of the manual"
- Index

General information

When using communication-capable 3VA molded case circuit breakers, please observe the following information:

Safety-relevant information

When working on or around electrical equipment, appropriate safety procedures must be followed. Proper isolation actions must be directly measured and verified. Operational or power status as directly provided by installed components, including the 3VA molded case circuit breaker, is not sufficient by itself to determine the operational or power status of the system. Independent verification is required.

See also

Technical Support (<http://support.automation.siemens.com>)

1.1 Security information

Siemens provides products and solutions with industrial security functions that support the secure operation of plants, systems, machines and networks.

In order to protect plants, systems, machines and networks against cyber threats, it is necessary to implement – and continuously maintain – a holistic, state-of-the-art industrial security concept. Siemens' products and solutions only form one element of such a concept.

Customer is responsible to prevent unauthorized access to its plants, systems, machines and networks. Systems, machines and components should only be connected to the enterprise network or the internet if and to the extent necessary and with appropriate security measures (e.g. use of firewalls and network segmentation) in place.

Additionally, Siemens' guidance on appropriate security measures should be taken into account. For more information about industrial security, please visit internet (<http://www.siemens.com/industrialsecurity>)

Siemens' products and solutions undergo continuous development to make them more secure. Siemens strongly recommends to apply product updates as soon as available and to always use the latest product versions. Use of product versions that are no longer supported, and failure to apply latest updates may increase customer's exposure to cyber threats.

To stay informed about product updates, subscribe to the Siemens Industrial Security RSS Feed (<http://www.siemens.com/industrialsecurity>).

1.2 Open Source Software

This product, solution or service ("Product") contains third-party software components listed in this document. These components are Open Source Software licensed under a license approved by the Open Source Initiative (www.opensource.org (<http://www.opensource.org>)) or similar licenses as determined by SIEMENS ("OSS") and/or commercial or freeware software components. With respect to the OSS components, the applicable OSS license conditions prevail over any other terms and conditions covering the Product. The OSS portions of this Product are provided royalty-free and can be used at no charge.

If SIEMENS has combined or linked certain components of the Product with/to OSS components licensed under the GNU LGPL version 2 or later as per the definition of the applicable license, and if use of the corresponding object file is not unrestricted ("LGPL Licensed Module", whereas the LGPL Licensed Module and the components that the LGPL Licensed Module is combined with or linked to is the "Combined Product"), the following additional rights apply, if the relevant LGPL license criteria are met: (i) you are entitled to modify the Combined Product for your own use, including but not limited to the right to modify the Combined Product to relink modified versions of the LGPL Licensed Module, and (ii) you may reverse-engineer the Combined Product, but only to debug your modifications. The modification right does not include the right to distribute such modifications and you shall maintain in confidence any information resulting from such reverse-engineering of a Combined Product.

Certain OSS licenses require SIEMENS to make source code available, for example, the GNU General Public License, the GNU Lesser General Public License and the Mozilla Public License. If such licenses are applicable and this Product is not shipped with the required source code, a copy of this source code can be obtained by anyone in receipt of this information during the period required by the applicable OSS licenses by contacting the following address:

Siemens AG
Energy Management
Low Voltage & Products
Technical Support
Postfach 10 09 53
93009 Regensburg
Germany

www.siemens.com/lowvoltage/support-request
(<https://support.industry.siemens.com/cs/us/en/ps>)

Keyword: Open Source Request (please specify Product name and version, if applicable)

SIEMENS may charge a handling fee to fulfil the request.

Warranty regarding further use of the Open Source Software

SIEMENS' warranty obligations are set forth in your agreement with SIEMENS. SIEMENS does not provide any warranty or technical support for this Product or any OSS components contained in it if they are modified or used in any manner not specified by SIEMENS. The license conditions listed below may contain disclaimers that apply between you and the respective licensor. For the avoidance of doubt, SIEMENS does not make any warranty commitment on behalf of or binding upon any third-party licensor.

System description

Communication-capable 3VA molded case circuit breakers are presented in this chapter. You will find out about the components that 3VA molded case circuit breakers require in order to communicate, how these components are interconnected and what properties they have.

In the system manual "3VA Molded Case Circuit Breaker Communication", the components are regarded merely as data suppliers or command receivers. The references in the Manual "3VA Molded Case Circuit Breakers with IEC Certification" (<http://support.automation.siemens.com/WW/view/de/90318775/0/en>) or in the Manual "3VA Molded Case Circuit Breakers with IEC and UL Certification" (<https://support.industry.siemens.com/cs/ww/en/view/109749082>) will direct you to more detailed information about the individual components.

The advantages of optimum integration of 3VA molded case circuit breakers into a software or communication system are as follows:

- Acquisition of breaker status (On, Off, Tripped)
- Monitoring of capacity utilization
- Acquisition of power data
- Creation of an energy data profile
- Local visual indication on a display
- Tracking of problems in the power distribution by means of a message archive with time stamp
- Downtimes can be avoided thanks to comprehensive maintenance information
- Performance and archiving of test functions using the TD500 test device
- Parameterization and wiring test of the electrical signals of the EFB300
- Parameterization and diagnostics of the plant from one location
- Remote switching of the 3VA molded case circuit breaker via the SEO (Stored Energy Operator / synchronizable motor operator)

2.1 Communication system of the 3VA molded case circuit breaker

The following components combine with the 3VA molded case circuit breaker to create a communication system:

- Electronic trip unit (ETU)
- COM800 / COM100 breaker data server
- Optional expansion modules for three other communication networks
- COM060 communication module
- Draw-out unit with communication interface
- RCD820 residual current device (RCD) - (IEC only)
- EFB300 external function box (EFB)
- DSP800 display
- Commissioning and service software: powerconfig

The diagram below presents the components which render a 3VA molded case circuit breaker capable of communication.

Communication system architecture for 3VA

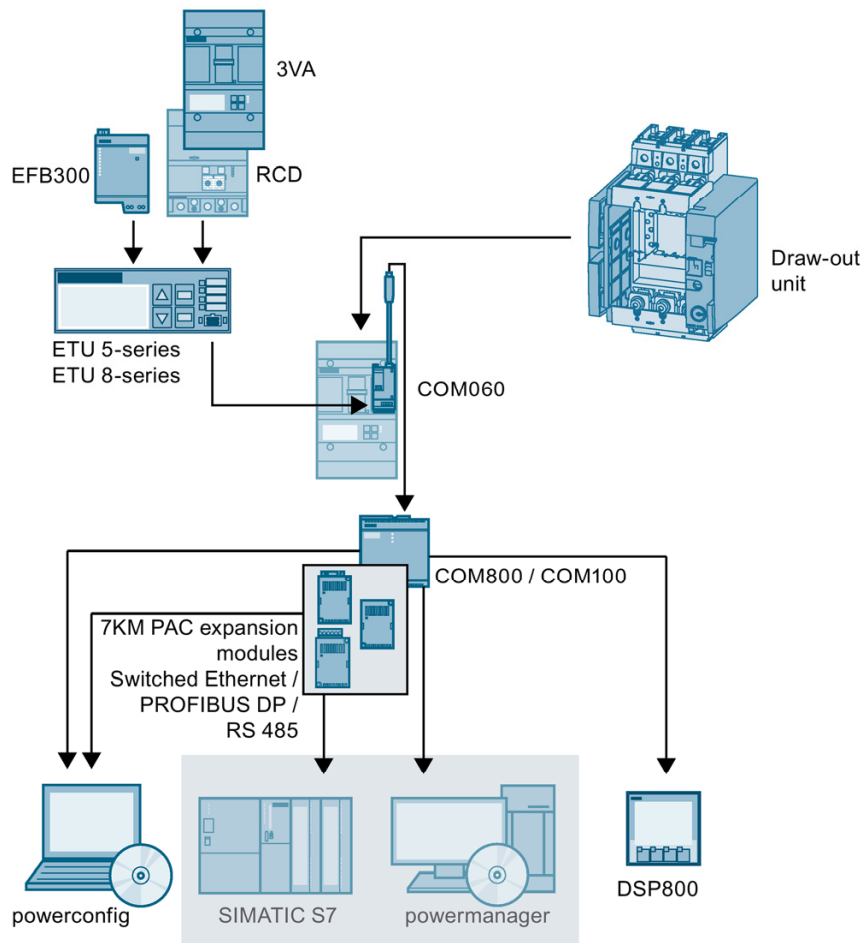

The central components of communication-capable 3VA molded case circuit breakers are the electronic trip units ETU 5-series or 8-series. The protection functions afforded by ETUs are described in the 3VA manual.

Typical communication partners are:

- SIMATIC S7
- powermanager

While reference is frequently made to these systems, they are not an integral part of the 3VA communication system.

See also

Manual "3VA Molded Case Circuit Breakers"
(<http://support.automation.siemens.com/WW/view/en/90318775>)

2.2 Access to the 3VA molded case circuit breaker via TD500

The TD500 test device can be used to test and commission 3VA molded case circuit breakers and to archive their settings.

This requires the following components:

- Electronic trip units (ETUs)
- TD500 test device
- powerconfig

Optional:

- EFB300 external function box (EFB)
- RCD820 residual current device (RCD) - (IEC only)

The diagram below shows the 3VA molded case circuit breaker components required for this purpose.

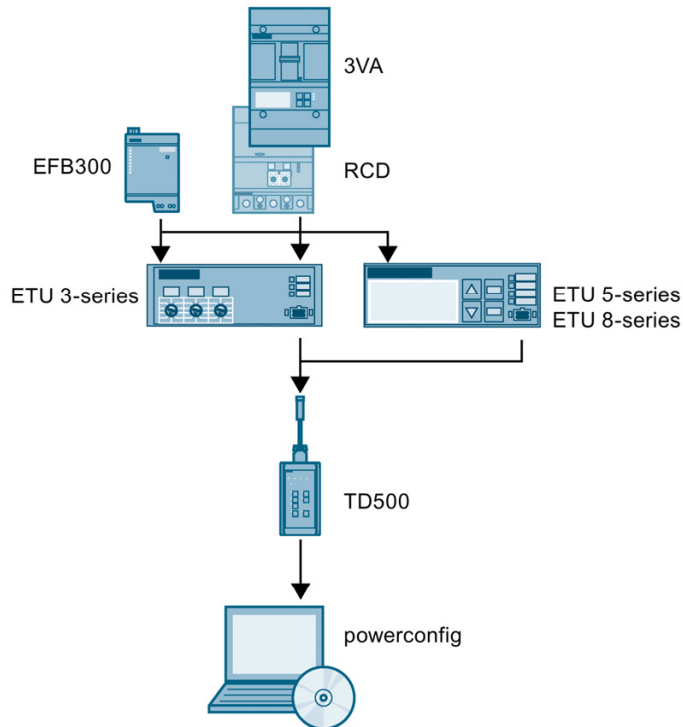

2.3 Information security

Due to the host of communication options, the 3VA molded case circuit breaker may be subject to inadvertent operator actions or even intentional information security attacks.

For this reason, the following is recommended:



1. Protect any physical access to the 3VA molded case circuit breaker in an appropriate manner, for example, by lockable doors. This particularly applies to access to the ETU.
2. Configure communication networks in accordance with section Security information (Page 15).
3. If you do not want to make the settings using communication, activate the write-protect switch on the COM800/COM100 after commissioning. The functions protected by the write-protect switch, e.g. remote switching, can be found in chapter Write-protect switch (Page 114)

2.4 COM800 / COM100 breaker data server

The COM800/COM100 breaker data servers can be used to integrate communication-capable 3VA molded case circuit breakers with ETUs 5-series and 8-series into communication networks of various types.

- The COM800 breaker data server supports a maximum of eight 3VA molded case circuit breakers
- The COM100 breaker data server supports one 3VA molded case circuit breaker

3VA molded case circuit breakers can be connected to higher-level communication networks by the following methods:

- Direct Ethernet connection to Modbus TCP
- 7KM PAC PROFIBUS DP expansion module to PROFIBUS DPV1 / V2
- 7KM PAC Switched Ethernet PROFINET expansion module to PROFINET IO and PROFINET energy, as well as Modbus TCP
- 7KM PAC RS 485 expansion module for Modbus RTU

3VA molded case circuit breakers are typically linked to the power monitoring software powermanager or the automation concept TIA (Totally Integrated Automation) via a communication network.

3VA molded case circuit breakers can also be connected to the commissioning and service software powerconfig.

The 3VA molded case circuit breakers can also be linked to many non-Siemens systems through such communication networks.

Furthermore, local visual indication on the DSP800 display can be implemented with the COM800/COM100 breaker data server.

Example: Configuration of the COM800/COM100 breaker data server with 3VA molded case circuit breakers and with connection to the power monitoring software powermanager (left), to the DSP800 (center) and to the commissioning and service software powerconfig (right).

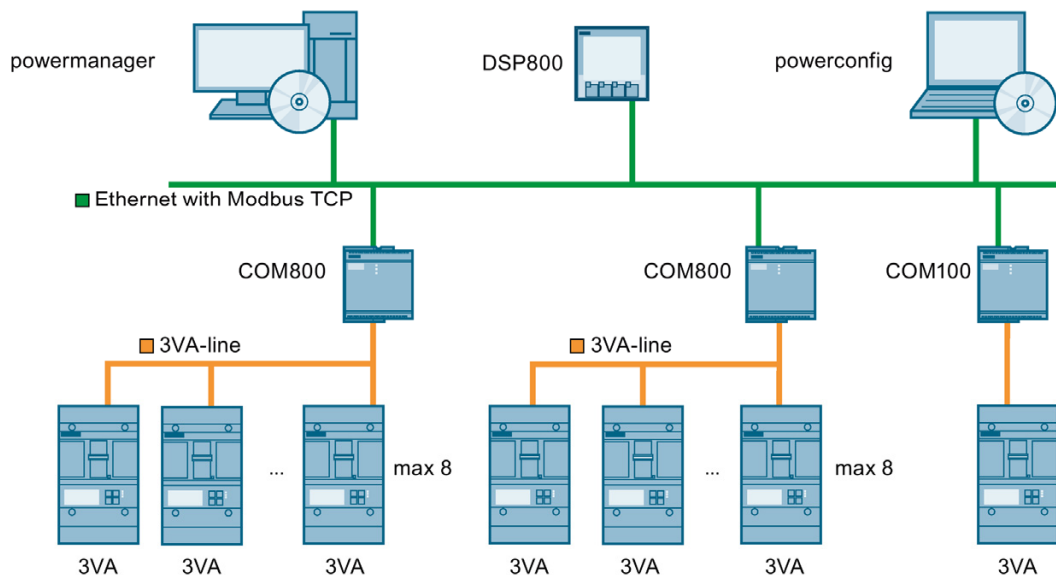

To establish a communication link, the COM800 or COM100 breaker data server is connected via the 3VA-line to the COM060 communication module of the relevant circuit breaker.

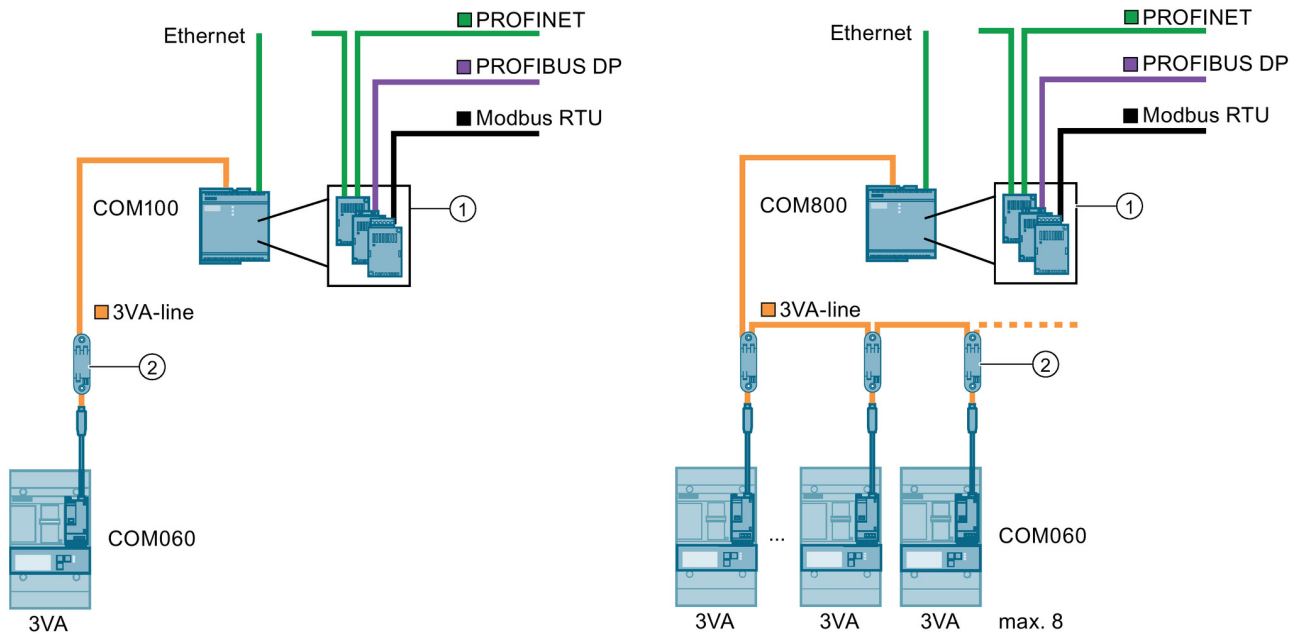

- ① 7KM PAC expansion modules
 ② T-connector

See also

DSP800 display (Page 28)

Connection, commissioning, operation (Page 101)

2.4.1 Area of application

The COM800/COM100 breaker data server can be used to link 3VA molded case circuit breakers to:

- Power monitoring software powermanager
- Industrial automation systems
- Building automation systems
- Maintenance systems

2.4.2 Features

Working in conjunction with the connected 3VA molded case circuit breakers with ETUs 5-series and 8-series, the COM800/COM100 breaker data server supplies the following information about the power distribution system:

- Condition of the 3VA molded case circuit breaker
- Tripping history with time stamp, cause of trip and number of trip events for breakers with ETUs 5-series and 8-series
- Minimum and maximum values of measured variables
- Limit-value monitoring for measured variables in the 3VA molded case circuit breakers
- Load curves with power demands, e.g. 15-minute demands
- Energy values such as active energy (kWh) and reactive energy (kvarh)

From a 24 V DC supply, the COM800/COM100 breaker data server with direct Ethernet connection supplies power to all the connected 3VA molded case circuit breakers and the following components:

- COM060 communication module
- ETUs 5-series and 8-series
- Communication interface of the guide frame
- 7KM PAC PROFIBUS DP expansion module
- 7KM PAC Switched Ethernet PROFINET expansion module
- 7KM PAC RS 485 expansion module

2.5 Communication with ETUs

Electronic trip units allow detailed setting of protection parameters from a central location. They record measured variables and maintenance information in order to support power and installation monitoring.

The electronic trip units (ETU) provide the following protection functions:

- Overload protection L ("L" = Long time)
- Short-time delayed short-circuit protection S ("S" = Short time) for time-selective response in case of a short-circuit
- Instantaneous short-circuit release I ("I" = Instantaneous)
- Protection of the neutral conductor against overload and short-circuit ("N" = Neutral)
- Protection against residual currents to ground ("G" = Ground fault)
- Motor protection functions, e.g. blocking protection and idling protection

2.5.1 Area of application

Communication-capable ETUs are deployed for any application which requires the following functions:

- Diverse protection functions
- Smaller increment of the setting parameters
- Metering functions
- for 50 Hz and 60 Hz systems (45 ... 65 Hz)
- Communication of the actual condition and history of the molded case circuit breaker

2.5.2 Features

Electronic trip units offer the following features:

- Display of absolute setting values, e.g. amperes, to allow detailed, flexible but simple setting of protection parameters
- Complete measurement of the current in the phases L1, L2 and L3, with N and currents to ground optional
- Integrated, precise Rogowski coils in all ETU variants
- Measurement of current with an accuracy of 1% at 0.2 to 1.2 I_n with ETUs 8-series
- Ground fault protection by precise computation of residual currents through vector sum calculation of phase and neutral conductor currents
- Evaluation of the current measurement values and constant comparison with the tripping limits
- Metering function, measurement of current and voltage, with calculation of power and energy values in the ETUs 8-series
- ETUs 8-series in conjunction with the COM800 / COM100 breaker data server: Recording the load profile of the power variables over 40 days

2.6 EFB300 external function box

The EFB300 external function box provides digital outputs and inputs.

The functions of these inputs and outputs can be programmed with the commissioning and service software powerconfig.

2.6.1 Area of application

3VA molded case circuit breakers equipped with the electronic trip unit systems ETU 3-series, ETU 5-series and ETU 8-series can be optionally upgraded with an EFB300 external function box.

The EFB300 external function box is used to output a wide range of electrical signals that indicate various states of the 3VA molded case circuit breaker. These signals can be connected to transmitters, e.g. lights, adjacent contact blocks or to signal acquisition devices of control systems.

It can be installed together with the 3VA molded case circuit breaker in the control cabinet or accessories cabinet.

2.6.2 Features

Below is a list of the possible events that can be selected by parameterization for output as electrical signals via the digital outputs of the EFB300:

- All trip causes differentiated according to LSIG, RCD - (for IEC only)
- Overload alarms AL1 and AL2
- Pre-trip alarm from overload protection system
- Output of an energy pulse (S0 signal) (with ETUs 8-series only)
- Load shedding
- Load acceptance
- Zone-selective interlocking ZSI

The digital input can be used to

- acknowledge output signals and reset them
- acquire an electrical signal from the environment and use it for communication purposes

The EFB300 external function box is supplied with 24 V DC and acts as a power supply for the connected ETU. This allows the ETU to remain operational even when a 3VA molded case circuit breaker has tripped.

2.7 DSP800 display

The DSP800 is used for visual indication directly at the enclosure.

The COM800/COM100 breaker data server can be combined with the DSP800 display to visualize switching states, measured variables and the parameter settings of the connected 3VA molded case circuit breakers. Information is visualized using preprogrammed menus and does not require software development.

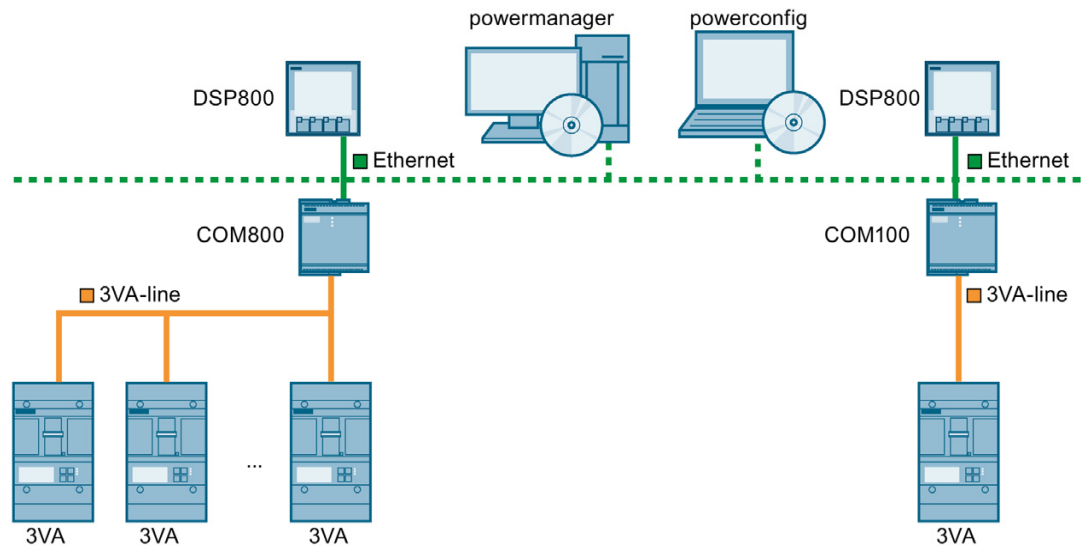

The DSP800 display is used to show the following variables of 3VA molded case circuit breakers:

- Measured variables such as current, voltage and energy values
- Circuit breaker states
- Settings of circuit breaker protection parameters

2.7.1 Area of application

The DSP800 display is deployed for any application which requires visual indication (i.e. directly at the distribution equipment) without additional software support.

The data from 3VA molded case circuit breakers that are difficult to access or inaccessible can be read from this display.

The DSP800 display can communicate directly via Ethernet or IP communication with the COM800/COM100 breaker data server. The DSP800 can function as a display while communicating simultaneously with the COM800/COM100 breaker data server.

2.7.2 Features

The DSP800 display is used to monitor up to eight 3VA molded case circuit breakers with ETUs 5-series and 8-series and has the following features:

- Display
 - Status of 3VA molded case circuit breaker
 - Current values
 - Voltage, power and energy variables (with ETUs 8-series)
 - Protection parameter settings
- Backlit LCD (W x H = 92 x 92 mm) [3.62 x 3.62 in]) that is easy to read thanks to
 - high resolution
 - inverse display
- Simple installation
 - door cutout sized 92 x 92 mm [3.62 x 3.62 in]
 - secured by clips
 - easy to network via RJ45 ports and Ethernet patch cable

2.8 TD500 test device

Using the mobile TD500 test device during the commissioning process, you can check that the system components connected to your 3VA molded case circuit breaker are functioning properly and correctly connected. The system behaves as it would in normal productive operation. The molded case circuit breaker trips when the set delay times expire and signals all alarms and tripped signals from connected components.

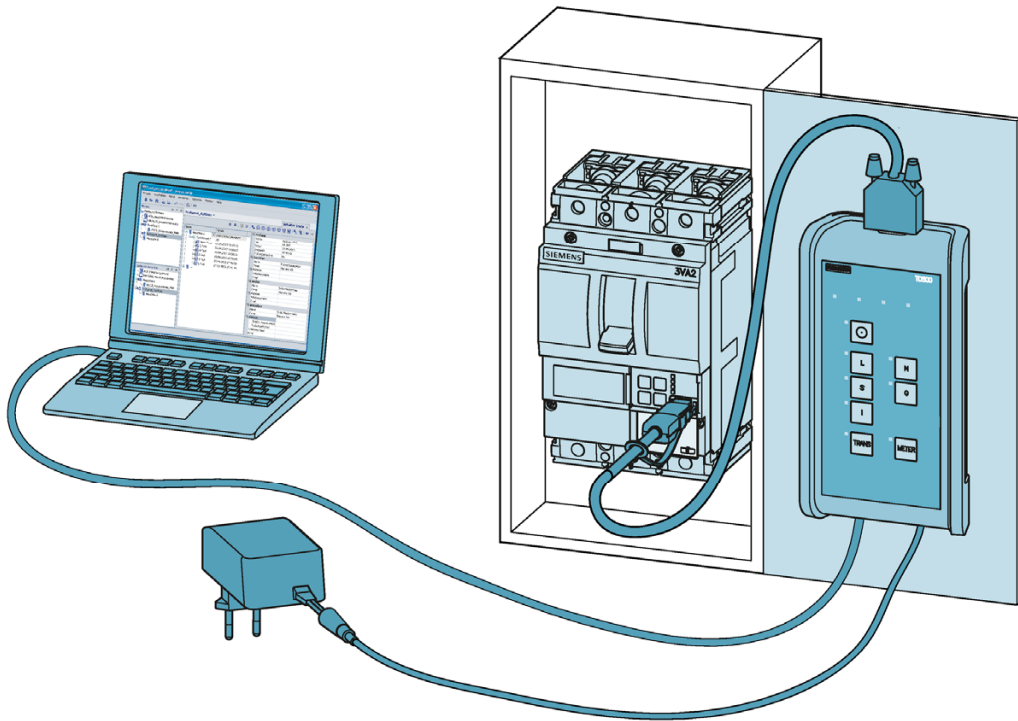

The TD500 test device is connected to the PC via a USB cable and is powered by the 24 V power pack (USB cable and power pack are supplied with the unit). A cable with plug-in connection supplied with the unit allows the test device to function as an interface to the ETU of the 3VA molded case circuit breaker. The test results can be evaluated, archived and stored as a file in ".csv" format with the commissioning and service software powerconfig. The setting parameters of the 3VA molded case circuit breaker can also be read out and changed.

2.8.1 Area of application

The TD500 test device can be deployed in conjunction with ETUs 3-series, 5-series and 8-series.

2.8.2 Features

The device tests all tripping functions of the 3VA molded case circuit breaker

- L = Overload protection
- S = Short-time delayed short-circuit protection
- I = Instantaneous short-circuit protection
- N = Neutral conductor protection
- G = Ground fault protection
- TRANS = Testing of energy transformers that supply ETUs
- METER = Testing of current metering function

The test device can also be used in conjunction with the commissioning and service software powerconfig to document the circuit breaker. Key data are as follows:

- Device type, e.g. article and serial number
- Plant and location identifiers
- Equipment used
- Parameter settings, particularly for ETUs 3-series
- Tests performed and test results

The TD500 test device is supplied with 24 V DC and acts as a power supply for the connected ETU. This allows the ETU to remain operational even when a 3VA molded case circuit breaker has tripped.

2.9 7KM PAC PROFIBUS DP expansion module

3VA molded case circuit breakers are integrated into TIA (Totally Integrated Automation) via PROFIBUS DP using the COM800/COM100 breaker data server and an attached 7KM PAC PROFIBUS DP expansion module.

The 3VA molded case circuit breakers supply the status and electrical measured variables for the automation system, maintenance information, messages, the control-based power management system powerrate, as well as I&C systems like the SIMATIC WinCC SCADA system.

Using the 7KM PAC PROFIBUS DP expansion module and the commissioning and service software powerconfig, it is possible to parameterize and diagnose 3VA molded case circuit breakers via PROFIBUS DP.

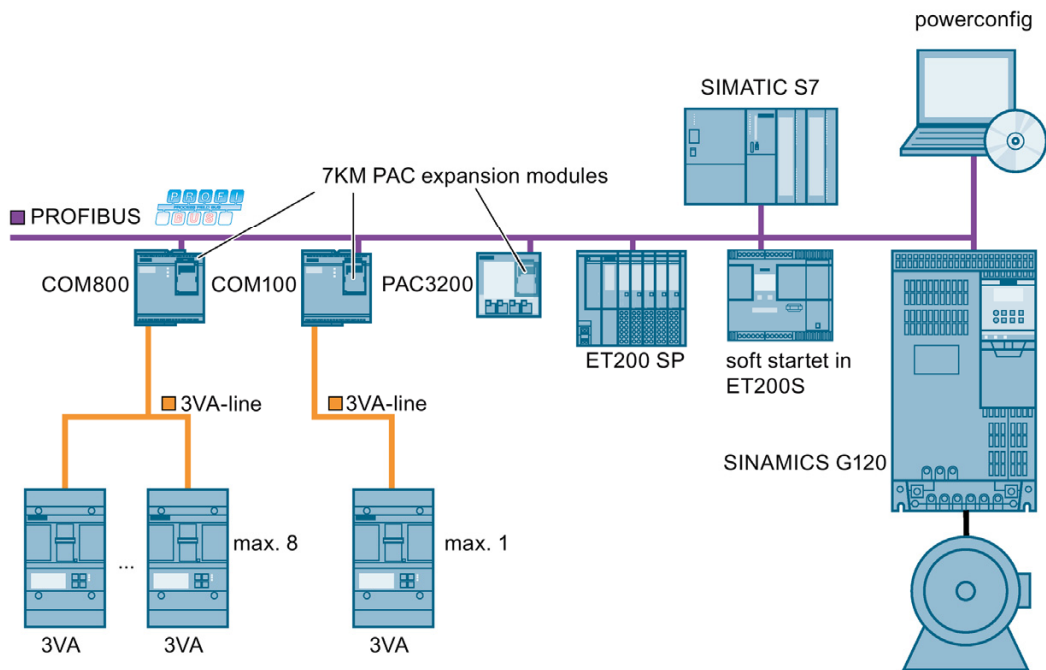

The 7KM PAC PROFIBUS DP expansion module is used to connect COM800/COM100 breaker data servers, and the 3VA molded case circuit breakers connected to them, to PROFIBUS DPV1.

You can find more information on PROFIBUS DP on the PROFIBUS Web site (<http://www.profibus.com>).

2.9.1 Area of application

The 7KM PAC PROFIBUS DP expansion module is primarily deployed in industrial automation systems in conjunction with SIMATIC or SIMOTION controllers and in drive systems like SINAMICS.

2.9.2 Features

The 7KM PAC PROFIBUS DP expansion module offers the following features:

- Communication based on the PROFIBUS DP master-slave principle:
The 7KM PAC PROFIBUS DP expansion module provides the status and measured variables of the 3VA molded case circuit breaker for the PROFIBUS DP master.
- The 7KM PAC PROFIBUS DP expansion module receives information (e.g. commands) from the PROFIBUS DP master, and transfers this information to the 3VA molded case circuit breaker.
- Function: PROFIBUS DP slave
- Communication with class 1 and class 2 masters
- Cyclic data transfer
- Acyclic data transfer
- Specific GSD file for the 3VA molded case circuit breaker, allowing correct integration of the breaker into the control system
- Automatic detection of the baud rate
- Time synchronization of the COM800/COM100 via PROFIBUS DPV2
- Setting of the PROFIBUS address:
 - With parameterization software
 - Via PROFIBUS, e.g. with TIA portal
- Generation of diagnostic interrupts and process interrupts
- Status display via LED
- Galvanic isolation between the 3VA molded case circuit breaker and PROFIBUS
- No external supply voltage required

2.10 7KM PAC Switched Ethernet PROFINET expansion module

Automation networking

3VA molded case circuit breakers connected to a COM800/COM100 breaker data server and equipped with a 7KM PAC Switched Ethernet PROFINET expansion module can be integrated into TIA (Totally Integrated Automation) via PROFINET.

The 3VA molded case circuit breaker supplies the status and electrical measured variables for the automation system, the control-based energy management system as well as I&C systems like the SIMATIC WinCC SCADA system. The commissioning and service software powerconfig can also be connected to 3VA molded case circuit breakers via this network configuration.

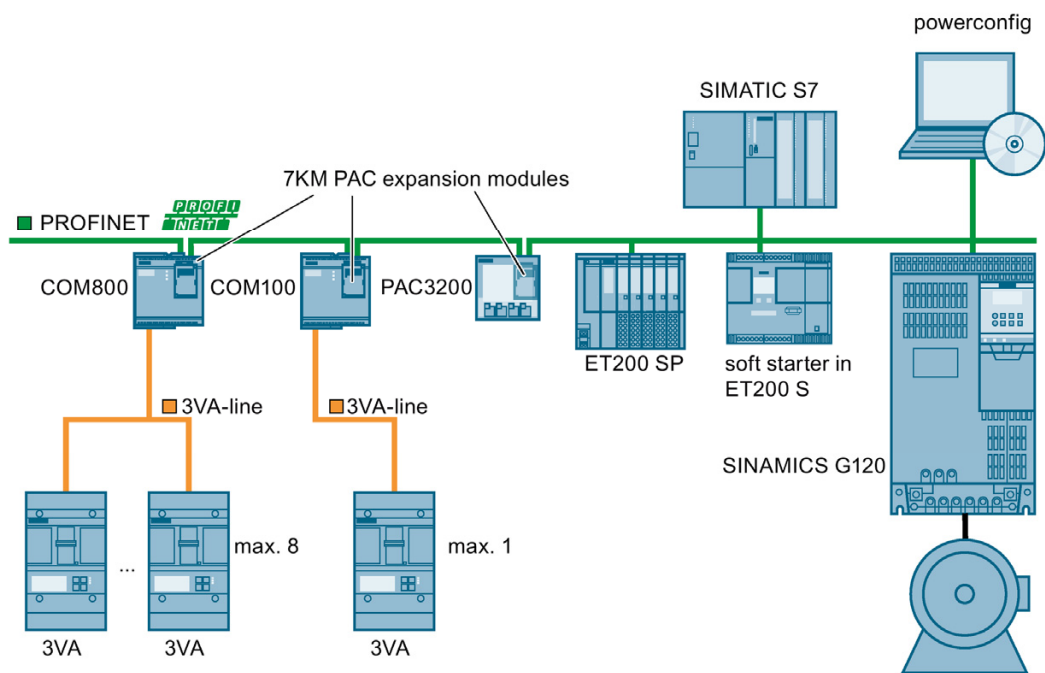

The appropriate components

(<http://support.automation.siemens.com/WW/view/en/37432205/133200>), e.g. of SIMATIC NET, must be used to create the PROFINET network.

The 7KM PAC Switched Ethernet PROFINET expansion module is used to connect COM800/COM100 breaker data servers to Switched Ethernet PROFINET via PROFINET IO, PROFlenergy and Modbus TCP.

2.10.1 Area of application

Typical applications for the 7KM PAC Switched Ethernet PROFINET expansion module are as follows:

- Industrial automation systems with exacting real-time requirements, primarily in conjunction with SIMATIC, SIMOTION and drive systems such as SINAMICS
- When a number of COM800/COM100 breaker data servers and 7KM PAC3200 / 7KM PAC4200 modules are installed in one switchboard installation, the network can be implemented in the form of a cable-saving linear structure with the help of the Ethernet switch integrated in the module.

2.10.2 Features

Automation networking

- Integrated Ethernet switch that reduces cabling requirements
- Optimum use of the process image of a controller thanks to the selection of individual basic types
- Simple engineering with SIMATIC TIA Portal or other programming systems thanks to the use of GDSML files
- Integration into time synchronization system
- When the 7KM PAC Switched Ethernet PROFINET expansion module is installed, all 3VA molded case circuit breaker communication functions can be utilized. It is then possible to make use of the powermanager and powerconfig software.
- Direct communication with SIMATIC, SIMOTION and SINAMICS via PROFINET IRT thanks to integrated, real-time Ethernet switch
- Measured variables of the 3VA molded case circuit breaker are supplied by the "Common Application Profile" PROFInergy developed by the PROFINET user organization (PNO).

2.11 7KM PAC RS 485 expansion module for Modbus RTU

The 3VA molded case circuit breakers can be connected to a Modbus RTU network with the COM800/COM100 breaker data server and an attached 7KM PAC RS 485 expansion module.

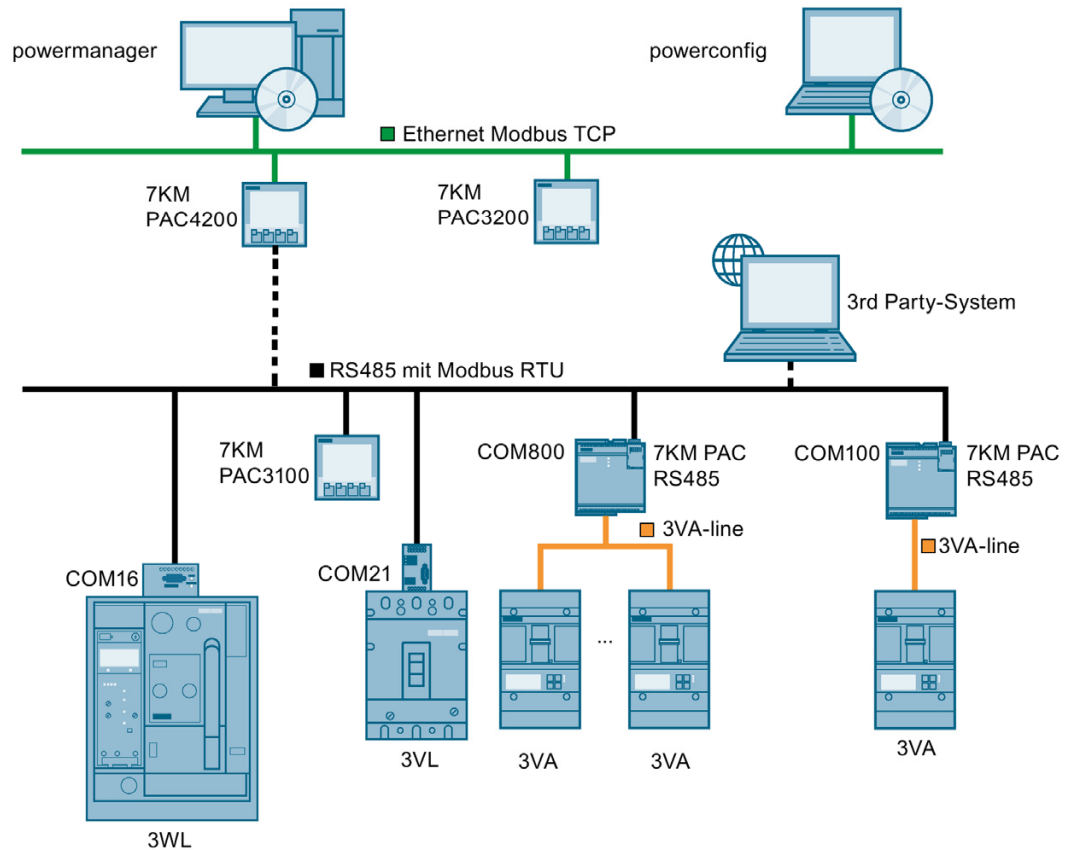

2.11.1 Area of application

The 7KM PAC RS 485 expansion module is used in the following areas:

- RS 485 networks with the Modbus RTU protocol are installed in many existing systems.
- RS 485 networks are a low-cost option for spanning medium distances (up to 1 km) without intermediate amplification.
- In the case of simple systems, RS 485 with Modbus RTU is often the only communication interface.

2.11.2 Features

The 7KM PAC RS 485 expansion module has the following features:

- 7KM PAC RS 485 plug-in expansion module for the COM800/COM100 breaker data servers
- Can be parameterized using the powerconfig commissioning and service software
- Support for the Modbus RTU protocol
- Data transfer rates 4.8/9.6 and 19.2 kbps are supported.
- Connection by means of 6-pole terminal connector.
- No external supply voltage required
- Status indication by LED on the module

If an existing system is expanded or upgraded with 3VA molded case circuit breakers, this network configuration results. Also when software from other vendors is available.

2.12 Commissioning and service software: powerconfig

The commissioning and service software powerconfig for communication-capable devices belongs to the SENTRON product range.

powerconfig performs the following functions in relation to 3VA molded case circuit breakers:

- Parameterization of ETUs 5-series and 8-series and other 3VA components
- Commissioning of 3VA molded case circuit breakers
- Function-testing of 3VA molded case circuit breakers with the TD500 test device
- Readout of measured variables such as energy, current, voltage and power from 3VA molded case circuit breakers
- Readout or reset of minimum and maximum values from 3VA molded case circuit breakers
- Readout and display of the load profile of the 3VA molded case circuit breakers, and saving of the load profile in a csv file that can be read in and displayed again later
- Statistical analysis of 3VA molded case circuit breakers
- Diagnosis of 3VA molded case circuit breakers
- Archiving of settings in digital form or as a printout
- Firmware updating

The PC on which powerconfig is installed is connected to the 3VA molded case circuit breaker by means of the COM800/COM100 breaker data server, optionally with modules or the TD500 test device. A TD500 test device is required in order to function-test 3VA molded case circuit breakers.

2.12.1 Area of application

- Simplified, rational parameterization of SENTRON devices
- Parameterization, documentation, operation and monitoring of 3VA, 3WL, 3VL circuit breakers, 7KM PAC3100 / 3200 / 4200 and ATC5300 measuring devices via various communication interfaces
- Monitoring and, when necessary, diagnosis of the low-voltage power distribution enclosure for the purpose of maintenance and servicing

2.12.2 Features

The commissioning and service software powerconfig has the following features:

- Clear presentation of the available parameters including validity testing of the inputs
- Display of the available device statuses and measured variables in standardized views
- Project-oriented storage of device data
- Consistent operation and usability
- Support for various device communication interfaces (e.g. Modbus TCP, PROFIBUS, PROFINET, and RS 485 via USB depending on the SENTRON device used)
- Supported languages:
 - German
 - English
 - Chinese
 - Portuguese
 - Spanish
 - Italian

For other languages, contact your sales partner.
- Readout and storage of device recordings (device-dependent)
- Updating of device firmware and loading of language packs (device-dependent)
- No programming knowledge required for operation

The screenshot displays the 'powerconfig' software interface for a 'Car Body Shop' project. The main workspace shows an 'Overview' for a circuit breaker. A bar chart indicates the current status for 'Phase L2' with a 'Maximum Conductor Current' of 35A. A red line marks the 'Overload release I_r 44 A'. To the right, a green box with a black 'X' indicates the circuit breaker is closed. A text box explains: 'The circuit breaker is closed. At the moment there are neither tripping nor warning or setpoint messages present.'

Plant Identifier	Rack 3
Location Identifier	Breaker 5
Current L1	35.0 A
Current L2	30.0 A
Current L3	30.0 A
Current N	10.0 A
Current G	0.0 A
System time	15/01/2016 10:0...

At the bottom of the workspace, the message log shows:

- Last Warning Message:** No messages available
- Last Trip Message:** The 3VA tripped because of an instantaneous short-circuit..

The status bar at the bottom indicates the system is 'Online' and '1 selected items' are shown.

3

Functions

As energy, operating and investment costs steadily increase, it is important for operators to keep track of actual power consumption and the status of the power distribution system. A 3VA molded case circuit breaker will require certain communication functions depending on how it is deployed and on the applications into which it is integrated.

For greater clarity, these communication functions can be assigned to one or several types of application:

1. Process control

Operative part of a production process, building or infrastructure

2. Power management

Acquisition, transparency and control of energy flows in a power distribution system

3. Operations management

Measures to provide and secure the electricity supply in a plant, especially when maintenance or servicing is in progress

4. Commissioning

Measures implemented at a power distribution system, from installation to handover to the operator.

Power distribution	Tasks	Life phases			Communication-based functions
		Engineering & installation	Operation	Maintenance	
	Commissioning	<ul style="list-style-type: none"> - Set protection parameters - Document completed tests 			<ul style="list-style-type: none"> - Set protection parameters - Transfer measured values - Control circuit breakers - Monitor states - Record operational events - Log faults - Archive test results - Document settings
	Operations management		<ul style="list-style-type: none"> - Fault management - Service management - Maintenance management 	<ul style="list-style-type: none"> - Optimize settings - Document changes/modifications - Evaluate causes of tripping - Analyze statistics - Isolate switchgear sections 	
	Power management		<ul style="list-style-type: none"> - Make power flows transparent - Allocate costs - Prevent peak loads 		
	Process control		<ul style="list-style-type: none"> - Monitor plant utilization - Monitor equipment - Commission or decommission equipment - Record energy costs 		

3.1 Parameterizing 3VA molded case circuit breakers

With ETUs 3-series, 5-series and 8-series, protection parameters can be set on the ETU itself. The references in the Manual "3VA Molded Case Circuit Breakers with IEC Certification" (<http://support.automation.siemens.com/WW/view/de/90318775/0/en>) and in the Manual "3VA Molded Case Circuit Breakers with IEC and UL Certification" (<https://support.industry.siemens.com/cs/ww/en/view/109749082>) will direct you to more detailed information about the individual components.

The primary function of 3VA molded case circuit breakers is to protect against overload, short circuits and ground faults. The tripping characteristics are graphically represented in the Time Current Curves.

All protection functions of the trip units work independently of one another.

All information pertaining to the status of the 3VA molded case circuit breaker can be accessed by users when the appropriate software and communication system are available.

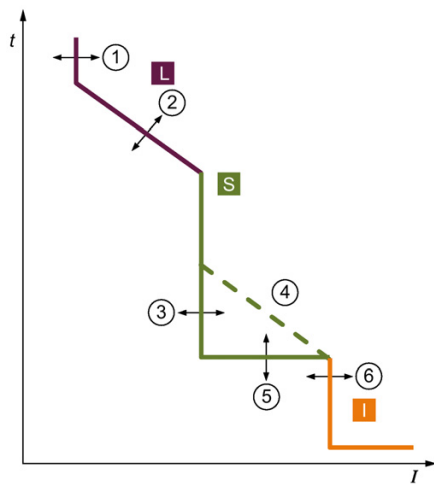

- | | |
|---|--|
| ① Response threshold of the long-time delayed protection | ⑥ Response threshold of the instantaneous protection |
| ② Delay of the long-time delayed protection | L Overload range |
| ③ Response threshold of the short-time delayed protection | S Short-time delayed short-circuit protection |
| ④ I^2t characteristic ON/OFF of the short-time delayed protection | I Instantaneous short-circuit protection |
| ⑤ Delay of the short-time delayed protection | |

In addition to the protection functions for phases, others are also provided:

- Protection of the neutral conductor
- Protection against residual current
- Protection against overtemperature

The protection parameters of 3VA molded case circuit breakers can be read out via a communication link. Protection parameters can be archived and documented at the end of the commissioning process.

With ETUs 5-series and 8-series, parameters can also be set using the powerconfig software.

The screenshot below shows the setting options in powerconfig:

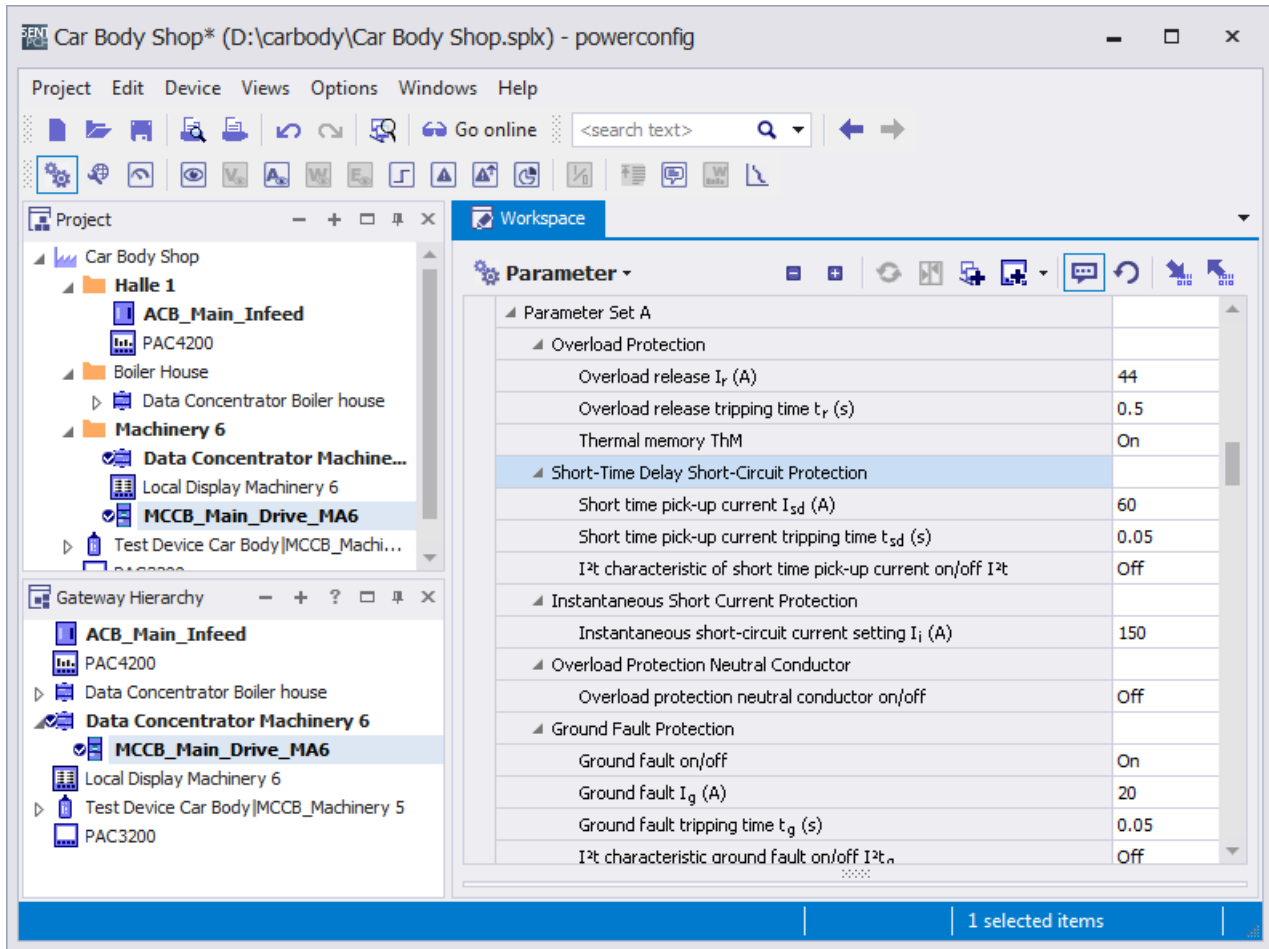

See also

Manual "3VA Molded Case Circuit Breakers"
<http://support.automation.siemens.com/WW/view/de/90318775/0/en>

3.2 Status of the molded case circuit breaker

The switching state of the 3VA molded case circuit breaker is an important item of information that the circuit breaker supplies. Information about the switching state is required for various purposes, i.e. for process control, power monitoring, operations management and commissioning. The switching state is transmitted via all communication channels and also displayed in powerconfig.

The screenshot shows the 'powerconfig' software interface for a 'Car Body Shop' project. The 'Overview' panel is active, displaying the following information:

- Text:** The circuit breaker is closed. At the moment there are neither tripping nor warning or setpoint messages present.
- Bar Chart:** Shows 'Phase L2' with a 'Maximum Conductor Current' of 35A. An 'Overload release' level is marked at I_r 44 A.
- Table:**

Plant Identifier	Rack 3
Location Identifier	Breaker 5
Current L1	35.0 A
Current L2	30.0 A
Current L3	30.0 A
Current N	10.0 A
Current G	0.0 A
System time	15/01/2016 10:0...
- Message Log:**
 - Last Warning Message: No messages available
 - Last Trip Message: The 3VA tripped because of an instantaneous short-circuit..

The status bar at the bottom indicates the device is 'Online' and '1 selected items' are shown.

3.2.1 Switching 3VA molded case circuit breakers

The 3VA molded case circuit breaker can also be switched with an SEO (Stored Energy Operator). The diagram below illustrates the possible switching states and the transitions between them.

A 3VA molded case circuit breaker can assume one of three switching states:

- ON: Current can flow
- OFF: Main contacts have been opened by a normal switching operation
- TRIP: Main contacts have been opened by protective trip or test function

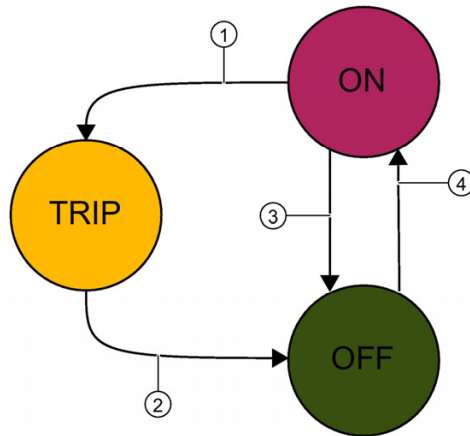

- | | |
|--|-----------------------------|
| <p>① - Protective trip
- Test function
- Shunt trip
- Undervoltage release</p> | <p>③ - SEO
- Manual</p> |
| <p>② - SEO (Stored Energy Operator)
- Manual</p> | <p>④ - SEO
- Manual</p> |

The switching states of 3VA molded case circuit breakers are detected by the COM060 communication module. The switching state information is communicated to the higher-level system or DSP800 via the COM800/COM100 breaker data server and displayed on the DSP800.

The 3VA molded case circuit breaker can be switched by means of the SEO (Stored Energy Operator). For this purpose corresponding values shall be written in a register.

Name	Access	ETU 5-series/ 8-series	COM800 / 100	COM060	SEO	Register address
Switching of the SEO	W		□	□	✓	0x9C5E
Status of the SEO	R		□	□	✓	0x5179

- R - Read access
- W - Write access
- - Requirement for availability of information
- ✓ - Supplies information

The 3VA molded case circuit breaker can be switched via PROFIBUS and PROFINET by means of the control bytes in accordance with the PI profile LVSG.

3.2.2 Switching state and accompanying information

The switching state is the most important information about a circuit breaker that is made available by the communication-capable 3VA molded case circuit breaker.

In addition to the three switching states ON / OFF / TRIP , there is further important accompanying information which influences the behavior and the status of the 3VA molded case circuit breaker, such as:

Name	Access	ETU 8-series	ETU 5-series	COM800 / COM100	COM060	EFB 300	DO ¹	RCD	Register address
Status of 3VA molded case circuit breaker	R			□	✓				0x00D9
Status of circuit breaker profile ²	R	✓	✓						0x00DA
Protection function status	R	✓	✓						0x00D2
Breaker status and diagnostic data	R	✓	✓	□					0x00CB
Metering function status	R	✓							0x00D5
Alarm status	R	✓	✓						0x0102
Limit violation status	R	✓	✓	□					0x0100
Status of the draw-out unit	R						✓		0x5175
EFB inputs and outputs	R	✓	✓			✓			0x516C
RCD status	R	□	□					✓	0x517B

- ¹ - Draw-out unit
- ² - Circuit breaker status according to PI profile, LVSG, see annex
- ✓ - Supplies information
- - Requirement for availability of information
- R - Read access

- **System time**

Name	Description	Access	Register address
System time ST*)	Value range of system time	RW	0x0098

RW - Read and write access

ST- System time

*) The system time and time stamp use the same format based on 2 x U32

1. U32: Number of seconds since 1st January 1970, without leap seconds.
This corresponds to UNIX time (epoch time).

2. U32: Fractions of current second, i.e. 2^{-32} seconds or about 4 millionths of a second.

- **Protection function status**

- Overload current in phases
- Overload current in neutral conductor
- Overtemperature alarm
- Protection function with trip capability
- ETU mode
- Metering function defective
- Electronic trip unit ETU defective

- **Status of metering function**

- Voltage unbalance in excess of threshold value
- Current unbalance in excess of threshold value
- Reference conditions (e.g. line frequency) for measured value accuracy outside permissible range

- **Alarm status**

- Pre-trip alarm for overload
- Alarm level 1 for overload
- Alarm level 2 for overload
- Ground fault protection alarm
- Overtemperature alarm
- Alarm to indicate violation of load shedding upper threshold limit
- Alarm to indicate violation of load shedding lower threshold limit
- Alarm to indicate internal ETU fault

- **Limit violation status**
 - Limit violation 0
 - Limit violation 1
 - Limit violation 2
 - Limit violation 3
 - Limit violation 4
 - Limit violation 5
 - Limit violation 6
 - Limit violation 7
 - Limit violation 8
 - Limit violation 9
 - Overload alarm present
 - Status of the write-protect switch
 - Reason for last trip (remains active until trip has been acknowledged)
 - Load shedding alarm
- **Breaker status**
 - Status of EFB300 missing *)
 - Status of SEO missing *)
 - *) Depending on the configuration
- **Trip counter**
 - Number of residual current trips
 - Number of temperature trips
 - Number of blocking protection trips
 - Number of G trips
 - Number of I trips
 - Number of L trips
 - Number of N trips
 - Number of phase failure trips
 - Number of all trips
- **Maintenance information**
 - Mechanical switching cycles
 - Operating hours counter

In any application in which a 3VA molded case circuit breaker is frequently switched in normal operation or by protection functions, the switching operation statistics supply important information.

The switching operation statistics are important for managing maintenance routines which can be implemented cost effectively when the number of trips and causes of tripping can be taken into account.

Name	ETU 8-series	ETU 5-series	COM800 / COM100	COM060	Unit	Access	Register address
Number of all trips	✓	✓				R	0x00E8
Number of residual current trips	✓	✓				R	0x00E2
Number of temperature trips	✓	✓				R	0x00E0
Number of G trips	✓	✓				R	0x00DF
Number of I trips	✓	✓				R	0x00DB
Number of L trips	✓	✓				R	0x00DD
Number of N trips	✓	✓				R	0x00DE
Number of S trips	✓	✓				R	0x00DC
Mechanical switching cycles				✓		R	0x00F8
Operating hours counter	✓				h	R	0x00E9
Operating hours counter COM800 / COM100			✓		s	R	0x4BFE

✓ - Supplies information

□ - Requirement for availability of information

R - Read access

See also

Switching 3VA molded case circuit breakers (Page 45)

3.2.3 Displaying draw-out status

In addition to fixed mounting, the 3VA molded case circuit breaker is also available in a draw-out version. In this case the circuit breaker sits in a guide frame and can be moved by means of a crank handle. The guide frame itself is connected to the main conducting paths. The draw-out version enables quick assembly and dismantling of the breaker, also without having to switch off the complete system. The position of the breaker in the guide frame can be detected by an additional component. This information can be forwarded via communication to higher-level systems (SIMATIC, powermanager) and used there. It is then possible from a remote position to see whether a breaker is in the CONNECT position and thus ready for operation.

If the 3VA molded case circuit breaker is moved by means of a crank handle into one of the following positions in the draw-out socket, the appropriate position signaling switch outputs an electrical signal that can be utilized for other purposes in the customer's installation:

- **CONNECT:**

The molded case circuit breaker is connected to the main circuit.

- **TEST:**

In the TEST position, the main contacts of the 3VA molded case circuit breaker are not connected to the main circuit, but only to the auxiliary circuit. It is therefore possible to verify that the auxiliary circuit is functioning properly when the main circuit is open.

- **DISCONNECT:**

The 3VA molded case circuit breaker is not connected to the main circuit or to the auxiliary circuit.

- **UNBLOCK:**

The 3VA molded case circuit breaker is not in any of the positions defined above and can be moved by means of the crank handle.

In the UNBLOCK state, the 3VA molded case circuit breaker is always switched off (contacts are open) or in the "TRIP" position (contacts are open). The molded case circuit breaker cannot be switched on from the UNBLOCK state.

Depending on the position of the 3VA molded case circuit breaker, the outputs of the position signaling switches assume one of the following states:

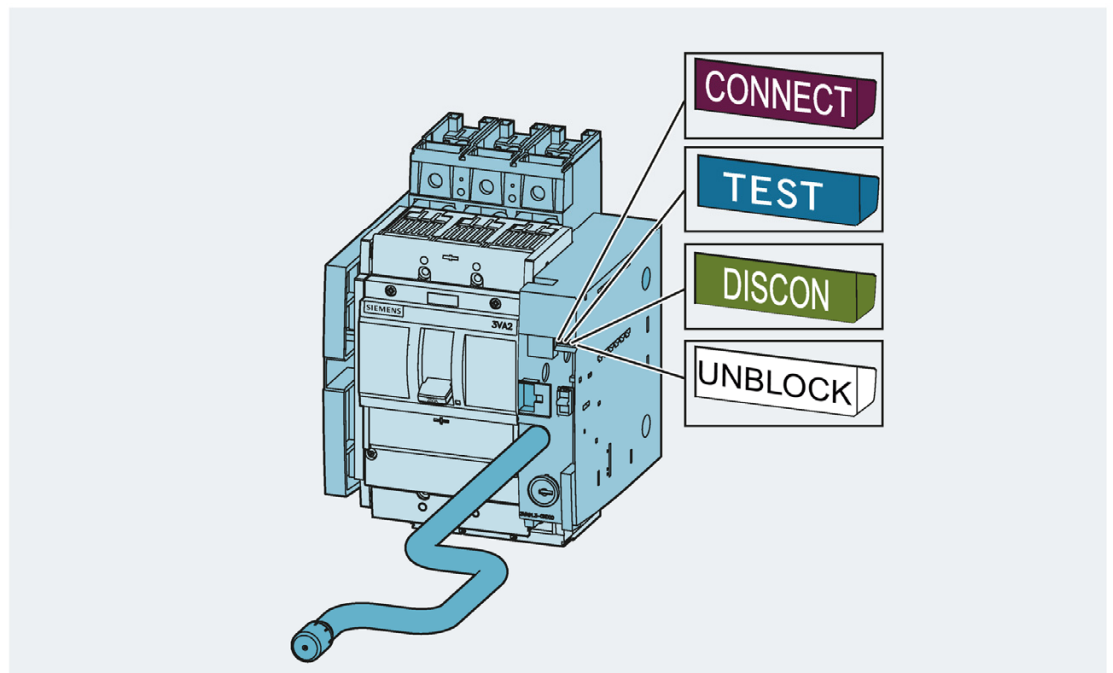

3.3 Test functions

The test functions simulate the protection functions of the ETUs of the 3VA molded case circuit breaker. Regular testing of these functions is recommended. You can find further information in chapter "Regular inspection" of the manual "3VA molded case circuit breakers".

The TD500 test device is used to test L, S, I, N and G tripping and proper functioning of the transformers.

The test results can be analyzed and archived with powerconfig.

The trips deliberately caused using the TD500 test device are also signaled via the EFB300 external function box. You can find more detailed information on this in chapter EFB300 external function box (Page 131)

You will find further information in chapter TD500 test device (Page 148) or in the 3VA molded case circuit breaker manual (<https://support.industry.siemens.com/cs/ww/en/view/90318775>).

3.4 Acquiring and communicating measured variables

Metering functions are essential to the implementation of precise process control, operations management and power management. The measured variables relevant to a particular application depend on whether the 3VA molded case circuit breaker is installed in the infeed, the sub-distribution board or directly in the process.

The measurable variables of 3VA molded case circuit breakers are summarized in the following table:

				ETUs		Display		Communication
				5-series	8-series	Display in ETU	DSP800	COM800 / COM100 via COM060
Current	Phase and neutral conductor currents	I_a, I_b, I_c, I_N	A	■	■	👁	👁	👁
	Residual current to ground	I_G	A	■	■	👁	👁	👁
	Phase with highest load		A	■	■	👁	👁	👁
	Mean value over the three phase currents	$I_{LAVG}(I_a + I_b + I_c)/3$	A	--	■	--	👁	👁
	Asymmetry of the phase currents	I_{nba}	%	--	■	--	👁	👁
	THD of the 3 phases	$THDI_a, THDI_b, THDI_c$	%	--	■	--	👁	👁
Voltage	Phase voltages incl. mean value	$U_{a,b,c}, U_{PHAVG}$	V	--	■	👁	👁	👁
	Voltages to N conductor incl. mean value	$U_{a-N}, U_{b-N}, U_{c-N}, U_{N-avg}$	V	--	■	--	👁	👁
	Asymmetry of the voltages		%	--	■	--	👁	👁
	THD phase/phase and phase/N	$THDU_{a-N}, THDU_{b-N}, THDU_{c-N}$	%	--	■	--	👁	👁
Power	Active power, total and per phase	P_a, P_b, P_c, P	kW	--	■	👁 (P)	👁	👁
	Apparent power, total and per phase	S_a, S_b, S_c, S	kVA	--	■	--	👁	👁
	Reactive power, total and per phase	Q_a, Q_b, Q_c, Q	kVAr	--	■	👁 (Q)	👁	👁
	Fundamental power factor	PF_a, PF_b, PF_c, PF		--	■	👁 (PF)	👁	👁
Energy	Active energy, infeed and feedback	E_a	kWh	--	■	👁	👁	👁
	Reactive energy, infeed and feedback	E_r	kVArh	--	■	--	👁	👁
	Apparent energy	E_{ap}	kVAh	--	■	--	👁	👁
Frequency	Present frequency	f	Hz	--	■	👁	👁	👁
Maximum pointer function	Min/max current, voltage, power	with time stamp		--	--	--	--	👁

- 👁 Value can be read
- Provided by the ETUs
- Not available

ANSI / L1 = a, L2 = b, L3 = c
UL

Measuring accuracy

The variables in the individual categories are measured with the following accuracy:

Category	Supplementary condition	Accuracy	Accuracy class acc. to IEC 61557-12
Current (ETU 8-series)	$0.2 \times I_N$ to $1.2 \times I_N$	1 % *)	
Current (ETU 5-series)	$0.2 \times I_N$ to $1.2 \times I_N$	10 % *)	
Voltage	$80 \text{ V} \leq U_{LN} \leq 800 \text{ V}$	1 % *)	
THD current	Up to 19th harmonic $0.2 \times I_N$ to $1.2 \times I_N$	5 % *)	
THD voltage	Up to 19th harmonic $80 \text{ V} \leq U_{LN} \leq 800 \text{ V}$	5 % *)	
Active power			Class 2
Reactive power	$0.2 \times I_N$ to $1.2 \times I_N$ LF ≥ 0.6 inductive, LF ≥ 0.8 capacitive	2 %	
Power factor (p.f.)	$0.2 \times I_N$ to $1.2 \times I_N$	0.05 absolute	
Active energy			Class 2
Reactive energy	$0.2 \times I_N$ to $1.2 \times I_N$ LF ≥ 0.6 inductive, LF ≥ 0.8 capacitive	2 %	
Frequency	$80 \text{ V} \leq U_{LN}$	0.1 %	

*) of the actual value

The measured variables of 3VA molded case circuit breakers can be used to monitor and meter power-related characteristics in a low-voltage distribution system to the specified level of accuracy. The accuracy specifications are valid at 23 °C ($\pm 2^\circ\text{C}$). At a different temperature, the accuracy can deviate by $\pm 0.05 \text{ %/K}$.

They are less suitable for open-loop and closed-loop control applications.

3.4.1 Current variables

Current measurements provide important information about capacity utilization and loading of the power distribution system.

The ETUs 5-series and 8-series supply the following current variables:

- Phase currents I_{L1} , I_{L2} , I_{L3} / I_a , I_b , I_c
- Neutral conductor current I_N
- Ground fault current I_G
- Maximum phase current; current in phase under highest load I_{L123} / I_{abc}
- The ETUs 8-series also supply the following current variables:
 - Average current $I_{L\text{ AVG}}$ / $I_{PH\text{ AVG}}$
 - Current unbalance

The maximum and minimum values of the current variables are also supplied. If time synchronization is configured, the maximum and minimum values are time-stamped.

Instantaneous values

Name	Description	IEC	ANSI	Unit	Access	Register address
Current L1 / a	Current in phase L1 / a	I_{L1}	I_a	A	R	0x0002
Current L2 / b	Current in phase L2 / b	I_{L2}	I_b	A	R	0x0004
Current L3 / c	Current in phase L3 / c	I_{L3}	I_c	A	R	0x0006
3-phase average current	3-phase average value of currents in phases	$I_{L\text{ AVG}}$	$I_{PH\text{ AVG}}$	A	R	0x0012
Neutral conductor current	Electric current in the neutral conductor.	I_N	I_n	A	R	0x0008
Ground fault current	Current between a live conductor (phase, neutral conductor) and ground	I_G	I_G	A	R	0x000A
Current unbalance	Current unbalance, calculated from the rms values of the currents	I_{nba}	I_{ampl}	%	R	0x0014
Highest phase current	Current of phase under highest load	$I_{L123\text{ max}}$	$I_{abc\text{ max}}$	A	R	0x0018
Phase with the highest current	Phase with the highest current	L1, L2, L3	a, b, c		R	0x0016

R - Read access

Maximum values including time stamp

Name	Description	IEC	ANSI	Unit	Access	Register address
Maximum current L1 / a	Maximum value of the current in phase L1 / a	$I_{L1 \text{ max}}$	$I_{a \text{ max}}$	A	R	0x0200
Maximum current L2 / b	Maximum value of the current in phase L2 / b	$I_{L2 \text{ max}}$	$I_{b \text{ max}}$	A	R	0x0206
Maximum current L3 / c	Maximum value of the current in phase L3 / c	$I_{L3 \text{ max}}$	$I_{c \text{ max}}$	A	R	0x020C
Maximum 3-phase average current	Maximum of the 3-phase average value of currents in the phases	$I_{L \text{ AVG max}}$	$I_{PH \text{ AVG max}}$	A	R	0x0230
Maximum neutral conductor current	Maximum value of the current in the neutral conductor.	$I_{N \text{ max}}$	$I_{n \text{ max}}$	A	R	0x0212
Maximum ground fault current	Maximum current between a live conductor (phase, neutral conductor) and ground	$I_{G \text{ max}}$	$I_{G \text{ max}}$	A	R	0x0218
Maximum current unbalance	Maximum value of the current unbalance	$I_{nba \text{ max}}$	$I_{ampl \text{ max}}$	%	R	0x0236

R - Read access

Minimum values including time stamp

Name	Description	IEC	ANSI	Unit	Access	Register address
Minimum current L1 / a	Minimum value of the current in phase L1 / a	$I_{L1 \text{ min}}$	$I_{a \text{ min}}$	A	R	0x0400
Minimum current L2 / b	Minimum value of the current in phase L2 / b	$I_{L2 \text{ min}}$	$I_{b \text{ min}}$	A	R	0x0406
Minimum current L3 / c	Minimum value of the current in phase L3 / c	$I_{L3 \text{ min}}$	$I_{c \text{ min}}$	A	R	0x040C
Minimum 3-phase average current	Minimum value of the 3-phase average value of currents in the phases	$I_{L \text{ AVG min}}$	$I_{PH \text{ AVG min}}$	A	R	0x0430
Minimum neutral conductor current	Minimum value of the current in the neutral conductor.	$I_{N \text{ min}}$	$I_{n \text{ min}}$	A	R	0x0412
Minimum ground fault current	Minimum current between a live conductor and ground.	$I_{G \text{ min}}$	$I_{G \text{ min}}$	A	R	0x0418
Minimum current unbalance	Minimum value of the current unbalance	$I_{nba \text{ min}}$	$I_{ampl \text{ min}}$	%	R	0x0436

R - Read access

3.4 Acquiring and communicating measured variables

3.4.2 Voltage variables

To ensure fault-free operation of all electrical loads, they must be supplied with voltage that is maintained within narrow tolerance levels. For this reason, the voltage variables at the infeed and directly at the load are relevant.

The ETUs 8-series supply the following voltage variables:

- Voltages U_{L1-L2} , U_{L2-L3} , U_{L3-L1} , U_{L1-N} , U_{L2-N} , U_{L3-N} / V_{a-b} , V_{b-c} , V_{c-a} , V_{a-n} , V_{b-n} , V_{c-n}
- Average voltage $U_{L-N AVG}$, $U_{L-L AVG}$ / $V_{PH-N AVG}$, $V_{PH-PH AVG}$
- Voltage unbalance U_{nba} / U_{nbal} V_{ampl}

The voltages and measured variables derived from them such as power and energy, for example, are acquired solely by ETUs 8-series.

3.4.2.1 Voltage variables L-N

Instantaneous values

Name	Description	IEC	ANSI	Unit	Access	Register address
Voltage L1-N / a-n	Value of voltage between phase L1 / a and the neutral conductor	U_{L1-N}	V_{a-n}	V	R	0x001A
Voltage L2-N / b-n	Value of voltage between phase L2 / b and the neutral conductor	U_{L2-N}	V_{b-n}	V	R	0x001C
Voltage L3-N / c-n	Value of voltage between phase L3 / c and the neutral conductor	U_{L3-N}	V_{c-n}	V	R	0x001E
3-phase average voltage L-N / PH-n	3-phase average value of the voltage between the phases and the neutral conductor	$U_{L-N AVG}$	$V_{PH-N AVG}$	V	R	0x0026

R - Read access

Maximum values including time stamp

Name	Description	IEC	ANSI	Unit	Access	Register address
Maximum voltage L1-N / a-n	Maximum value of voltage between phase L1 / a and the neutral conductor	$U_{L1-N max}$	$V_{a-n max}$	V	R	0x023C
Maximum voltage L2-N / b-n	Maximum value of voltage between phase L2 / b and the neutral conductor	$U_{L2-N max}$	$V_{b-n max}$	V	R	0x0242
Maximum voltage L3-N / c-n	Maximum value of voltage between phase L3 / c and the neutral conductor	$U_{L3-N max}$	$V_{c-n max}$	V	R	0x0248
Maximum value of the 3-phase average voltage L-N	Maximum value of the 3-phase average voltage between the phases and the neutral conductor	$U_{L-N AVG max}$	$V_{PH-N AVG max}$	V	R	0x0260

R - Read access

Minimum values including time stamp

Name	Description	IEC	ANSI	Unit	Access	Register address
Minimum voltage L1-N / a-n	Minimum value of voltage between phase L1 / a and the neutral conductor	$U_{L1-N \text{ min}}$	$V_{a-n \text{ min}}$	V	R	0x043C
Minimum voltage L2-N / b-n	Minimum value of voltage between phase L2 / b and the neutral conductor	$U_{L2-N \text{ min}}$	$V_{b-n \text{ min}}$	V	R	0x0442
Minimum voltage L3-N / c-n	Minimum value of voltage between phase L3 / c and the neutral conductor	$U_{L3-N \text{ min}}$	$V_{b-n \text{ min}}$	V	R	0x0448
Minimum value of the 3-phase average voltage L-N / PH-n	Minimum value of the 3-phase average voltage between the phases and the neutral conductor	$U_{L-N \text{ AVG min}}$	$V_{PH-N \text{ AVG min}}$	V	R	0x0460

R - Read access

3.4.2.2 Voltage variables L-L

Instantaneous values

Name	Description	IEC	ANSI	Unit	Access	Register address
Voltage L1-L2 / a-b	Value of the voltage between phases L1 / a and L2 / b	U_{L1-L2}	V_{a-b}	V	R	0x0020
Voltage L2-L3 / b-c	Value of the voltage between phases L2 / b and L3 / c	U_{L2-L3}	V_{b-c}	V	R	0x0022
Voltage L3-L1 / c-a	Value of the voltage between phases L3 / c and L1 / a	U_{L3-L1}	V_{c-a}	V	R	0x0024
3-phase average voltage L-L / PH-PH	Average of the 3-phase voltages	$U_{L-L \text{ AVG}}$	$V_{PH-PH \text{ AVG}}$	V	R	0x0028
Voltage unbalance	Voltage unbalance, calculated from the rms values of the phase voltages	U_{nba}	V_{ampl}	%	R	0x002A

R - Read access

3.4 Acquiring and communicating measured variables

Maximum values including time stamp

Name	Description	IEC	ANSI	Unit	Access	Register address
Maximum voltage L1-L2 / a-b	Maximum value of the voltage between phases L1 / a and L2 / b	U _{L1-L2 max}	V _{a-b max}	V	R	0x024E
Maximum voltage L2-L3 / b-c	Maximum value of the voltage between phases L2 / b and L3 / c	U _{L2-L3 max}	V _{b-c max}	V	R	0x0254
Maximum voltage L3-L1 / c-a	Maximum value of the voltage between phases L3 / c and L1 / a	U _{L3-L1 max}	V _{c-a max}	V	R	0x025A
Maximum value of the 3-phase average voltage L-L / PH-PH	Maximum 3-phase average value of the phase voltages	U _{L-L AVG max}	V _{PH-PH AVG max}	V	R	0x0266
Maximum voltage unbalance	Maximum value of the voltage unbalance	U _{nba max}	V _{ampl max}	%	R	0x026C

R - Read access

Minimum values including time stamp

Name	Description	IEC	ANSI	Unit	Access	Register address
Minimum voltage L1-L2 / a-b	Minimum value of the voltage between phases L1 / a and L2 / b	U _{L1-L2 min}	V _{a-b min}	V	R	0x044E
Minimum voltage L2-L3 / b-c	Minimum value of the voltage between phases L2 / b and L3 / c	U _{L2-L3 min}	V _{b-c min}	V	R	0x0454
Minimum voltage L3-L1 / c-a	Minimum value of the voltage between phases L3 / c and L1 / a	U _{L3-L1 min}	V _{c-a min}	V	R	0x045A
Minimum 3-phase Average voltage L-L / PH-PH	Minimum 3-phase average value of the phase voltages	U _{L-L AVG min}	V _{PH-PH AVG min}	V	R	0x0466
Minimum voltage unbalance	Minimum value of the voltage unbalance	U _{nba min}	V _{ampl min}	%	R	0x046C

R - Read access

3.4.3 Measuring power

With 3VA molded case circuit breakers, the power demand of the connected loads is measured without the installation of additional measuring equipment. The measurement results are made available to process control, power monitoring or power management systems.

ETUs 8-series supply the following measured variables for this purpose:

- Power values
 - $P_{L1}, P_{L2}, P_{L3}, P / W_a, W_b, W_c, W$
 - $Q_{totL1}, Q_{totL2}, Q_{totL3}, Q_{tot} / VAR_{tot a}, VAR_{tot b}, VAR_{tot c}, VAR_{tot}$
 - $S_{L1}, S_{L2}, S_{L3}, S_{tot} / VA_a, VA_b, VA_c, VA_{a tot}$
- Average imported and exported power $P, Q_{tot} / W, VAR_{tot}$ of last and present measuring interval and the apparent power S of the last and present measuring interval
- Power factors
 - $LF_{L1}, LF_{L2}, LF_{L3}, LF / PF_a, PF_b, PF_c, PF$

3.4.3.1 Active power

Actual measured values

Instantaneous values

Name	Description	IEC	ANSI	Unit	Access	Register address
Active power L1 / a	Active power in phase L1 / a as import (+) or export (-)	$\pm P_{L1}$	$\pm W_a$	W	R	0x0030
Active power L2 / b	Active power in phase L2 / b as import (+) or export (-)	$\pm P_{L2}$	$\pm W_b$	W	R	0x0032
Active power L3 / c	Active power in phase L3 / c as import (+) or export (-)	$\pm P_{L3}$	$\pm W_c$	W	R	0x0034
Total active power	Total active power in phases as import (+) or export (-)	$\pm P$	$\pm W$	W	R	0x0036

R - Read access

3.4 Acquiring and communicating measured variables

Maximum values including time stamp

Name	Description	IEC	ANSI	Unit	Access	Register address
Maximum active power L1 / a	Maximum value of active power in phase L1 / a	$P_{L1 \max}$	$W_{a \max}$	A	R	0x0278
Maximum active power L2 / b	Maximum value of active power in phase L2 / b	$P_{L2 \max}$	$W_{b \max}$	A	R	0x027E
Maximum active power L3 / c	Maximum value of active power in phase L3 / c	$P_{L3 \max}$	$W_{c \max}$	A	R	0x0284
Maximum total active power	Maximum value of the total active power in the 3-phase system	$\pm P_{\max}$	$\pm W_{\max}$	W	R	0x028A

R - Read access

Minimum values including time stamp

Name	Description	IEC	ANSI	Unit	Access	Register address
Minimum active power L1 / a	Minimum value of active power in phase L1 / a	$\pm P_{L1 \min}$	$\pm W_{a \min}$	W	R	0x0478
Minimum active power L2 / b	Minimum value of active power in phase L2 / b	$\pm P_{L2 \min}$	$\pm W_{b \min}$	W	R	0x047E
Minimum active power L3 / c	Minimum value of active power in phase L3 / c	$\pm P_{L3 \min}$	$\pm W_{c \min}$	W	R	0x0484
Minimum total active power	Minimum value of the total active power in the 3-phase system	$\pm P_{\min}$	$\pm W_{\min}$	W	R	0x048A

R - Read access

Present measuring interval

Name	Description	IEC	ANSI	Unit	Access	Register address
Active power import in the present period	Cumulated active power import in the present period	P	W	W	R	0x442A
Active power export in the present period	Cumulated active power export in the present period	P	W	W	R	0x442E
Maximum active power in the present period	Maximum active power in the present period	P_{\max}	W_{\max}	W	R	0x4436
Minimum active power in the present period	Minimum active power in the present period	P_{\min}	W_{\min}	W	R	0x4438

R - Read access

Last measuring interval

Name	Description	IEC	ANSI	Unit	Access	Register address
Active power import in the last period	Cumulated active power import in the last period	P	W	W	R	0x4412
Active power export in the last period	Cumulated active power export in the last period	P	W	W	R	0x4416
Maximum active power in the last period	Maximum active power in the last period	P _{max}	W _{max}	W	R	0x441E
Minimum active power in the last period	Minimum active power in the last period	P _{min}	W _{min}	W	R	0x4420

R - Read access

3.4.3.2 Reactive power

Actual measured values

Instantaneous values

Name	Description	IEC	ANSI	Unit	Value range	Access	Register address
Total reactive power Q _{tot L1} / VAR _{tot a}	Total reactive power in phase L1 / a referred to the load counting system, fundamental, and harmonics	Q _{tot L1}	VAR _{tot a}	var	[0;1807000]	R	0x0040
Total reactive power Q _{tot L2} / VAR _{tot b}	Total reactive power in phase L2 / b referred to the load counting system, fundamental, and harmonics	Q _{tot L2}	VAR _{tot b}	var	[0;1807000]	R	0x0042
Total reactive power Q _{tot L3} / VAR _{tot c}	Total reactive power in phase L3 / c referred to the load counting system, fundamental, and harmonics	Q _{tot L3}	VAR _{tot c}	var	[0;1807000]	R	0x0044
Total reactive power Q _{tot} / VAR _{tot}	Total reactive power Q _{tot} / VAR _{tot} in the phases from fundamental and harmonics referred to the load counting system	Q _{tot}	VAR _{tot}	var	[0;5421000]	R	0x0046

R - Read access

3.4 Acquiring and communicating measured variables

Maximum values including time stamp

Name	Description	IEC	ANSI	Unit	Value range	Access	Register address
Maximum total reactive power Q_{tot} L1 / VAR_{tot} a max	Maximum value of the total reactive power in phase L1 / a referred to the load counting system, fundamental, and harmonics	Q_{tot} L1 max	VAR_{tot} a max	var	[0;1807000]	R	0x02A8
Maximum total reactive power Q_{tot} L2 / VAR_{tot} b max	Maximum value of the total reactive power in phase L2 / b referred to the load counting system, fundamental, and harmonics	Q_{tot} L2 max	VAR_{tot} b max	var	[0;1807000]	R	0x02AE
Maximum total reactive power Q_{tot} L3 / VAR_{tot} c max	Maximum value of the total reactive power in phase L3 / c referred to the load counting system, fundamental, and harmonics	Q_{tot} L3 max	VAR_{tot} c max	var	[0;1807000]	R	0x02B4
Maximum total reactive power Q_{tot} / VAR_{tot} max	Maximum value of the total reactive power of the fundamental and harmonics in the 3-phase system	Q_{tot} max	VAR_{tot} max	var	[0;5421000]	R	0x02BA

R - Read access

Minimum values including time stamp

Name	Description	IEC	ANSI	Unit	Value range	Access	Register address
Minimum total reactive power Q_{tot} L1 / VAR_{tot} a min	Minimum value of the total reactive power in phase L1 / a referred to the load counting system, fundamental, and harmonics	Q_{tot} L1 min	VAR_{tot} a min	var	[0;1807000]	R	0x04A8
Minimum total reactive power Q_{tot} L2 / VAR_{tot} b min	Minimum value of the total reactive power in phase L2 / b referred to the load counting system, fundamental, and harmonics	Q_{tot} L2 min	VAR_{tot} b min	var	[0;1807000]	R	0x04AE
Minimum total reactive power Q_{tot} L3 / VAR_{tot} c min	Minimum value of the total reactive power in phase L3 / c referred to the load counting system, fundamental, and harmonics	Q_{tot} L3 min	VAR_{tot} c min	var	[0;1807000]	R	0x04B4
Minimum total reactive power Q_{tot} / VAR_{tot} min	Minimum value of the total reactive power of the fundamental and harmonics in the 3-phase system	Q_{tot} min	VAR_{tot} min	var	[0;5421000]	R	0x04BA

R - Read access

Present measuring interval

Name	Description	IEC	ANSI	Unit	Value range	Access	Register address
Reactive power import in the present period	Cumulated reactive power import Q_{tot} / VAR_{tot} in the present period	Q_{tot}	VAR_{tot}	var	[0;5421000]	R	0x442C
Reactive power export in the present period	Cumulated reactive power export Q_{tot} / VAR_{tot} in the present period	Q_{tot}	VAR_{tot}	var	[0;5421000]	R	0x4430
Maximum reactive power in the present period	Maximum reactive power Q_{tot} / VAR_{tot} in the present period	Q_{tot} max	VAR_{tot} max	var	[0;5421000]	R	0x443A
Minimum reactive power in the present period	Minimum reactive power Q_{tot} / VAR_{tot} in the present period	Q_{tot} min	VAR_{tot} min	var	[0;5421000]	R	0x443C

R - Read access

Last measuring interval

Name	Description	IEC	ANSI	Unit	Value range	Access	Register address
Reactive power import in the last period	Cumulated reactive power import Q_{tot} / VAR_{tot} in the present period	Q_{tot}	VAR_{tot}	var	[0;5421000]	R	0x4414
Reactive power export in the last period	Cumulated reactive power export Q_{tot} / VAR_{tot} in the last period	Q_{tot}	VAR_{tot}	var	[0;5421000]	R	0x4418
Maximum reactive power in the last period	Maximum reactive power Q_{tot} / VAR_{tot} in the last period	Q_{tot} max	VAR_{tot} max	var	[0;5421000]	R	0x4422
Minimum reactive power in the last period	Minimum reactive power Q_{tot} / VAR_{tot} in the last period	Q_{tot} min	VAR_{tot} min	var	[0;5421000]	R	0x4424

R - Read access

3.4.3.3 Apparent power

Actual measured values

Instantaneous values

Name	Description	IEC	ANSI	Unit	Value range	Access	Register address
Apparent power L1 / a	Apparent power in phase L1 / a	S _{L1}	VA _a	VA	[0;1807000]	R	0x0038
Apparent power L2 / b	Apparent power in phase L2 / b	S _{L2}	VA _b	VA	[0;1807000]	R	0x003A
Apparent power L3 / c	Apparent power in phase L3 / c	S _{L3}	VA _c	VA	[0;1807000]	R	0x003C
Total apparent power	Total apparent power in the phases	S	VA	VA	[0;5421000]	R	0x003E

R - Read access

Maximum values

Name	Description	IEC	ANSI	Unit	Value range	Access	Register address
Maximum apparent power L1 / a	Maximum value of the apparent power in phase L1 / a	S _{L1 max}	VA _{a max}	VA	[0;1807000]	R	0x0290
Maximum apparent power L2 / b	Maximum value of the apparent power in phase L2 / b	S _{L2 max}	VA _{b max}	VA	[0;1807000]	R	0x0296
Maximum apparent power L3 / c	Maximum value of the apparent power in phase L3 / c	S _{L3 max}	VA _{c max}	VA	[0;1807000]	R	0x029C
Maximum total apparent power	Maximum value of the total apparent power in the 3-phase system	S _{max}	VA _{max}	VA	[0;5421000]	R	0x02A2

R - Read access

Minimum values

Name	Description	IEC	ANSI	Unit	Value range	Access	Register address
Minimum apparent power L1 / a	Minimum value of apparent power in phase L1 / a	S _{L1 min}	VA _{a min}	VA	[0;1807000]	R	0x0490
Minimum apparent power L2 / b	Minimum value of apparent power in phase L2 / b	S _{L2 min}	VA _{b min}	VA	[0;1807000]	R	0x0496
Minimum apparent power L3 / c	Minimum value of apparent power in phase L3 / c	S _{L3 min}	VA _{c min}	VA	[0;1807000]	R	0x049C
Minimum total apparent power	Minimum value of the total apparent power in the 3-phase system	S _{min}	VA _{min}	VA	[0;5421000]	R	0x04A2

R - Read access

Present measuring interval

Name	Description	IEC	ANSI	Unit	Values range	Access	Register address
Apparent power in the present period	Cumulated apparent power in the present period	S	VA	VA	[0;5421000]	R	0x4428
Maximum apparent power in the present period	Maximum apparent power in the present period	S _{max}	VA _{max}	VA	[0;5421000]	R	0x4432
Minimum apparent power in the present period	Minimum apparent power in the present period	S _{min}	VA _{min}	VA	[0;5421000]	R	0x4434

R - Read access

Last measuring interval

Name	Description	IEC	ANSI	Unit	Value range	Access	Register address
Apparent power in the last period	Cumulated apparent power in the last period	S	VA	VA	[0;5421000]	R	0x4410
Maximum apparent power in the last period	Maximum apparent power in the last period	S _{max}	VA _{max}	VA	[0;5421000]	R	0x441A
Minimum apparent power in the last period	Minimum apparent power in the last period	S _{min}	VA _{min}	VA	[0;5421000]	R	0x441C

R - Read access

3.4.3.4 Power factors**Instantaneous values**

Name	Description	IEC	ANSI	Unit	Value range	Access	Register address
Power factor L1 / a	Power factor (arithmetic) in phase L1 / a	PF _{L1}	PF _a		[0;1]	R	0x0050
Power factor L2 / b	Power factor (arithmetic) in phase L2 / b	PF _{L2}	PF _b		[0;1]	R	0x0052
Power factor L3 / c	Power factor (arithmetic) in phase L3 / c	PF _{L3}	PF _c		[0;1]	R	0x0054
Total power factor	Total power factor	PF	PF		[0;1]	R	0x0056

R - Read access

3.4 Acquiring and communicating measured variables

Maximum values including time stamp

Name	Description	IEC	ANSI	Unit	Value range	Access	Register address
Maximum power factor L1 / a	Maximum value of the power factor (arithmetic) in phase L1 / a	PF _{L1 max}	PF _{a max}		[0;1]	R	0x02D8
Maximum power factor L2 / b	Maximum value of the power factor (arithmetic) in phase L2 / b	PF _{L2 max}	PF _{b max}		[0;1]	R	0x02DE
Maximum power factor L3 / c	Maximum value of the power factor (arithmetic) in phase L3 / c	PF _{L3 max}	PF _{c max}		[0;1]	R	0x02E4
Maximum total power factor	Maximum total power factor	PF _{max}	PF _{max}		[0;1]	R	0x02EA

R - Read access

Minimum values including time stamp

Name	Description	IEC	ANSI	Unit	Value range	Access	Register address
Minimum power factor L1 / a	Minimum value of the power factor (arithmetic) in phase L1 / a	PF _{L1 min}	PF _{a min}		[0;1]	R	0x04D8
Minimum power factor L2 / b	Minimum value of the power factor (arithmetic) in phase L2 / b	PF _{L2 min}	PF _{b min}		[0;1]	R	0x04DE
Minimum power factor L3 / c	Minimum value of the power factor (arithmetic) in phase L3 / c	PF _{L3 min}	PF _{c min}		[0;1]	R	0x04E4
Minimum total power factor	Minimum total power factor	PF _{min}	PF _{min}		[0;1]	R	0x04EA

R - Read access

3.4.4 Measuring energy

With 3VA molded case circuit breakers, the energy flow through the connected loads is measured without the installation of additional measuring equipment. The measurement results are made available to power monitoring or power management systems.

ETUs 8-series supply the following measured variables for this purpose:

- Imported and exported active energy
- Imported and exported reactive energy
- Apparent energy

3.4.4.1 Energy variables

	Description	IEC	ANSI	Unit	Value range	Access	Register address
Active energy	Active energy import	$E_{a\ imp}$	$Wh_{\ imp}$	kWh	[0;131900000]	RW	0x007A
	Active energy export	$E_{a\ exp}$	$Wh_{\ exp}$	kWh	[0;131900000]	RW	0x007E
Reactive energy	Reactive energy import	$E_{r\ imp}$	VARh	kvarh	[0;131900000]	RW	0x0082
	Reactive energy export	$E_{r\ exp}$	VARh	kvarh	[0;131900000]	RW	0x0086
Apparent energy	Apparent energy	E_{ap}	VAh	kVAh	[0;131900000]	RW	0x008A

RW - Read and write access

3.4.5 Evaluating the load profile

The 3VA molded case circuit breakers with ETUs 8-series record the load profile with the following measured variables:

- Imported active energy
- Imported reactive energy
- Exported active energy
- Exported reactive energy
- Apparent energy
- Mean total active power
- Mean total reactive power
- Mean total apparent power
- Minimum and maximum values
- Time of day and actual duration of period

The load profile encompasses up to 3840 time periods, e.g. for recording the 15 min values over 40 days. If the load profile is not backed up within this time, the oldest periods are overwritten (= ring buffer).

The period duration can be set via powerconfig.

Powermanager should be used for continuous evaluation and archiving of the load profile. You can find more information in chapter Power monitoring with powermanager (Page 95).

For sporadic reading out of the load profile, powerconfig version 3.4 or higher can also be used. You can find more information in chapter Commissioning and service software: powerconfig (Page 211).

3.4.6 Measuring the frequency and harmonic content

With 3VA molded case circuit breakers, the frequency and harmonic content of the connected loads is measured without the installation of additional measuring equipment. The measurement results are made available to the operations management system for monitoring purposes.

ETUs 8-series supply the following measured variables for this purpose:

- Actual, minimum and maximum frequency
- Harmonic content of the currents THD_{L1}, THD_{L2}, THD_{L3} / THD_a, THD_b, THD_c
- Harmonic content of the voltages THD_{L1-N}, THD_{L2-N}, THD_{L3-N}, THD_{L1-L2}, THD_{L2-L3}, THD_{L3-L1} / THD_{a-n}, THD_{b-n}, THD_{c-n}, THD_{a-b}, THD_{b-c}, THD_{c-a}

3.4.6.1 Frequency variables

	Name	Description	IEC	ANSI	Unit	Value range	Access	Register address
Instantaneous values	Line frequency	Line frequency value	f	f	Hz	[45;65]	R	0x002E
Maximum values including time stamp	Maximum line frequency	Maximum value of the line frequency	f _{max}	f _{max}	Hz	[45;65]	R	0x0272
Minimum values including time stamp	Minimum line frequency	Minimum value of the line frequency	f _{min}	f _{min}	Hz	[45;65]	R	0x0472

R - Read access

3.4.6.2 Harmonic content

Current THDs

	Name	Description	IEC	ANSI	Unit	Value range	Access	Register address
Instantaneous values	THD current L1 / a	Harmonic content (Total Harmonic Distortion) of the current in phase L1 / a referred to the fundamental	THD _{IL1}	THD _{Ia}	%	[0;250]	R	0x005E
	THD current L2 / b	Harmonic content of the current in phase L2 / b referred to the fundamental	THD _{IL2}	THD _{Ib}	%	[0;250]	R	0x0060
	THD current L3 / c	Harmonic content of the current in phase L3 / c referred to the fundamental	THD _{IL3}	THD _{Ic}	%	[0;250]	R	0x0062

3.4 Acquiring and communicating measured variables

	Name	Description	IEC	ANSI	Unit	Value range	Access	Register address
Maximum values including time stamp	Maximum THD current L1 / a	Maximum harmonic content of the current in phase L1 / a referred to the fundamental	THD _{IL1} max	THD _{I a} max	%	[0;250]	R	0x0302
	Maximum THD current L2 / b	Maximum harmonic content of the current in phase L2 / b referred to the fundamental	THD _{IL2} max	THD _{I b} max	%	[0;250]	R	0x0308
	Maximum THD current L3 / c	Maximum harmonic content of the current in phase L3 / c referred to the fundamental	THD _{IL3} max	THD _{I c} max	%	[0;250]	R	0x030E

R - Read access

THD of the voltage L-N / phase-neutral

Instantaneous values

Name	Description	IEC	ANSI	Unit	Value range	Access	Register address
THD voltage L1 / a	Harmonic content of the voltage between phase L1 / a and the neutral conductor referred to the fundamental	THD _{UL1}	THD _{V a}	%	[0;100]	R	0x0064
THD voltage L2 / b	Harmonic content of the voltage between phase L2 / b and the neutral conductor referred to the fundamental	THD _{UL2}	THD _{V b}	%	[0;100]	R	0x0066
THD voltage L3 / c	Harmonic content of the voltage between phase L3 / c and the neutral conductor referred to the fundamental	THD _{UL3}	THD _{V c}	%	[0;100]	R	0x0068

R - Read access

3.4 Acquiring and communicating measured variables

Maximum values including time stamp

Name	Description	IEC	ANSI	Unit	Value range	Access	Register address
Maximum THD voltage L1 / a	Maximum harmonic content of the voltage between phase L1 / a and the neutral conductor referred to the fundamental	THD _{UL1} max	THD _{V a} max	%	[0;100]	R	0x0314
Maximum THD voltage L2 / b	Maximum harmonic content of the voltage between phase L2 / b and the neutral conductor referred to the fundamental	THD _{UL2} max	THD _{V b} max	%	[0;100]	R	0x031A
Maximum THD voltage L3 / c	Maximum harmonic content of the voltage between phase L3 / c and the neutral conductor referred to the fundamental	THD _{UL3} max	THD _{V c} max	%	[0;100]	R	0x0320

R - Read access

Minimum values including time stamp

Name	Description	IEC	ANSI	Unit	Value range	Access	Register address
Minimum THD voltage L1 / a	Minimum harmonic content of the voltage between phase L1 / a and the neutral conductor referred to the fundamental	THD _{UL1} min	THD _{V a} min	%	[0;100]	R	0x0514
Minimum THD voltage L2 / b	Minimum harmonic content of the voltage between phase L2 / b and the neutral conductor referred to the fundamental	THD _{UL2} min	THD _{V b} min	%	[0;100]	R	0x051A
Minimum THD voltage L3 / c	Minimum harmonic content of the voltage between phase L3 / c and the neutral conductor referred to the fundamental	THD _{UL3} min	THD _{V c} min	%	[0;100]	R	0x0520

R - Read access

THD of the voltage L-L / phase-phase

Instantaneous values

Name	Description	IEC	ANSI	Unit	Value range	Access	Register address
THD voltage L1-L2 / a-b	Harmonic content of the voltage between phases L1 / a and L2 / b referred to the fundamental	THD _{UL1-L2}	THD _{V a-b}	%	[0;100]	R	0x006A
THD voltage L2-L3 / b-c	Harmonic content of the voltage between phases L2 / b and L3 / c referred to the fundamental	THD _{UL2-L3}	THD _{V b-c}	%	[0;100]	R	0x006C
THD voltage L3-L1 / c-a	Harmonic content of the voltage between phases L3 / c and L1 / a referred to the fundamental	THD _{UL3-L1}	THD _{V c-a}	%	[0;100]	R	0x006E

R - Read access

Maximum values including time stamp

Name	Description	IEC	ANSI	Unit	Value range	Access	Register address
Maximum THD voltage L1-L2 / a-b	Maximum harmonic content of the voltage between phase L1 / a and phase L2 / b referred to the fundamental	THD _{UL1-L2 max}	THD _{V a-b max}	%	[0;100]	R	0x0326
Maximum THD voltage L2-L3 / b-c	Maximum harmonic content of the voltage between phase L2 / b and phase L3 / c referred to the fundamental	THD _{UL2-L3 max}	THD _{V b-c max}	%	[0;100]	R	0x032C
Maximum THD voltage L3-L1 / c-a	Maximum harmonic content of the voltage between phase L3 / c and phase L1 / a referred to the fundamental	THD _{UL3-L1 max}	THD _{V c-a max}	%	[0;100]	R	0x0332

R - Read access

Minimum values including time stamp

Name	Description	IEC	ANSI	Unit	Value range	Access	Register address
Minimum THD voltage L1-L2 / a-b	Minimum harmonic content of the voltage between phases L1 / a and L2 / b referred to the fundamental	THD _{UL1-L2 min}	THD _{V a-b min}	%	[0;100]	R	0x0526
Minimum THD voltage L2-L3 / b-c	Minimum harmonic content of the voltage between phases L2 / b and L3 / c referred to the fundamental	THD _{UL2-L3 min}	THD _{V b-c min}	%	[0;100]	R	0x052C
Minimum THD voltage L3-L1 / c-a	Minimum harmonic content of the voltage between phases L3 / c and L1 / a referred to the fundamental	THD _{UL3-L1 min}	THD _{V c-a min}	%	[0;100]	R	0x0532

R - Read access

3.5 Messages

The 3VA molded case circuit breaker provides 3 kinds of message:



1. **Operational messages** document events which might occur during normal operation. These include:
 - When protective tripping occurs, the trip cause and, if appropriate, the phase which initiated the trip are recorded.
 - Switching operations: A message is generated every time the circuit breaker is switched on or off.
 - Limit or threshold violations: Up to 10 different limit values can be monitored by the user. The limit values can refer to different measured variables depending on the type of ETU used. Hysteresis, delay time, greater/less than, and category can be programmed for each limit value.
 - Changes to the configuration at the 3VA-line are always logged.
2. **Operator action messages** document operator actions by the user at the 3VA molded case circuit breaker system.

Recording of operator action messages can be controlled via four event types:

 - Parameter changes
 - Reset extreme values
 - Reset energy storage
 - 3VA with unknown version connected to COM800/COM100
3. **System messages** document events which cause a significant change to the 3VA molded case circuit breaker system. System messages are always recorded.

These events are stored retentively and fail-safe in the 3VA molded case circuit breaker system. At an appropriate time (even after power supply recovery), the events can be read out via the commissioning and service software powerconfig or (in future) via the power monitoring software powermanager or a process control system. System messages can be analyzed by the user.

The extent to which events are recorded can be controlled via powerconfig so that message recording can be tailored to specific requirements. You can find more information in chapter Parameterizing 3VA molded case circuit breakers (Page 222)

The categories Information , Warning  and Alarm  can also be selected.

You can find more information on the categories in chapter Understanding status transitions (Page 251).

3.6 Available database

Units of information such as status information or measured variables are made available in suitable data formats by products in the SENTRON range.

3.6.1 Data formats and byte ordering

Abbreviation	Description
U8	unsigned 8-bit
U16	unsigned 16-bit
U32	unsigned 32-bit
FP32	floating point 32-bit
FP64	floating point 64-bit
TS	time stamp
ST	system time

Individual units of information are identified by register addresses. A register is 16 bits in size. If a unit of information is larger than 16 bits, it will require the corresponding number of registers.

The individual data types are stored as described in the table below:

Register		U8	U16	U32	FP32
Register address	High Byte	0x00	High Data Byte	High Data Byte	1st Data Byte (sign Bit)
	Low Byte	Data Byte	Low Data Byte	2nd Data Byte	2nd Data Byte
Register address + 1	High Byte	-	-	3rd Data Byte	3rd Data Byte
	Low Byte	-	-	Low Data Byte	Last Data Byte
Number of registers		1	1	2	2

Example of bit counting using a 32-bit data format:

Bit	31	-	24	23	-	16	15	-	8	7	-	0
Byte	High Byte			Low Byte			High Byte			Low Byte		
Register	Register address						Register address + 1					

Float32 (FP32) and Float64 (FP64) are stored in accordance with the following tables:

Representation of the 32-bit floating-point number (single precision) in accordance with IEEE 754

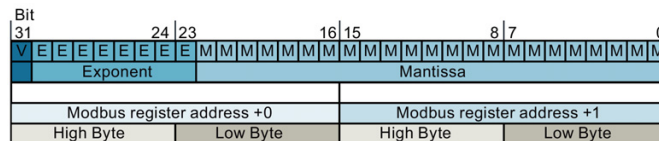

Representation of the 64-bit floating-point number (double precision) in accordance with IEEE 754

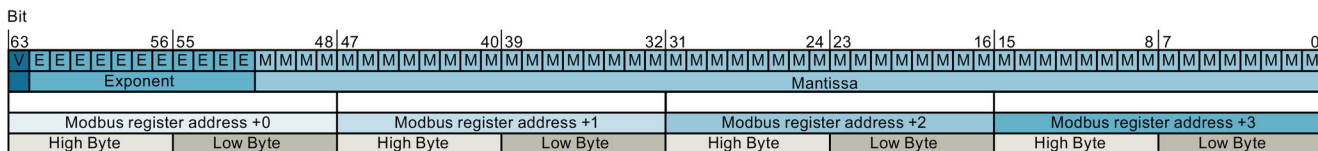

Representation of the system time or the time stamp

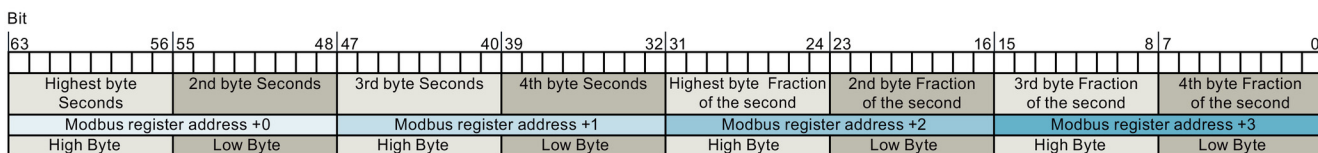

Invalid contents of registers:

Temporary events such as interruption of the 3VA-line make it necessary to designate the contents of registers as invalid since no valid values are available.

Invalid values are represented by hexadecimal FF in every data format.

If validity is important for an application, the register contents must be checked for "not equal to FF" before processing.

3.6.2 Data contents and register addresses

Register address	Number of registers	Name	Format	Breaker address / COM800 / COM100	Value range	Access
0x0002	2	Current L1	FP32	Breaker address		R
0x0004	2	Current L2	FP32	Breaker address		R
0x0006	2	Current L3	FP32	Breaker address		R
0x0008	2	Neutral conductor current	FP32	Breaker address		R
0x000A	2	Ground fault current	FP32	Breaker address		R
0x0012	2	3-phase average current	FP32	Breaker address		R
0x0014	2	Current unbalance	FP32	Breaker address		R
0x0016	1	Phase with the highest current	U16	Breaker address	[0;3]	R
0x0018	2	Maximum phase current	FP32	Breaker address		R
0x001A	2	Voltage L1-N	FP32	Breaker address		R
0x001C	2	Voltage L2-N	FP32	Breaker address		R
0x001E	2	Voltage L3-N	FP32	Breaker address		R
0x0020	2	Voltage L1-L2	FP32	Breaker address		R
0x0022	2	Voltage L2-L3	FP32	Breaker address		R
0x0024	2	Voltage L3-L1	FP32	Breaker address		R
0x0026	2	3-phase average voltage L-N	FP32	Breaker address		R
0x0028	2	3-phase average voltage L-L	FP32	Breaker address		R
0x002A	2	Voltage unbalance	FP32	Breaker address		R
0x002E	2	Line frequency	FP32	Breaker address		R
0x0030	2	Active power L1	FP32	Breaker address		R
0x0032	2	Active power L2	FP32	Breaker address		R
0x0034	2	Active power L3	FP32	Breaker address		R
0x0036	2	Total active power	FP32	Breaker address		R
0x0038	2	Apparent power L1	FP32	Breaker address		R
0x003A	2	Apparent power L2	FP32	Breaker address		R
0x003C	2	Apparent power L3	FP32	Breaker address		R
0x003E	2	Total apparent power	FP32	Breaker address		R
0x0040	2	Total reactive power Q_{tot} L1	FP32	Breaker address		R
0x0042	2	Total reactive power Q_{tot} L2	FP32	Breaker address		R
0x0044	2	Total reactive power Q_{tot} L3	FP32	Breaker address		R
0x0046	2	Total reactive power Q_{tot}	FP32	Breaker address		R
0x0050	2	Power factor L1	FP32	Breaker address		R
0x0052	2	Power factor L2	FP32	Breaker address		R
0x0054	2	Power factor L3	FP32	Breaker address		R

Register address	Number of registers	Name	Format	Breaker address / COM800 / COM100	Value range	Access
0x0056	2	Total power factor	FP32	Breaker address		R
0x005E	2	THD current L1	FP32	Breaker address		R
0x0060	2	THD current L2	FP32	Breaker address		R
0x0062	2	THD current L3	FP32	Breaker address		R
0x0064	2	THD voltage L1	FP32	Breaker address		R
0x0066	2	THD voltage L2	FP32	Breaker address		R
0x0068	2	THD voltage L3	FP32	Breaker address		R
0x006A	2	THD voltage L1-L2	FP32	Breaker address		R
0x006C	2	THD voltage L2-L3	FP32	Breaker address		R
0x006E	2	THD voltage L3-L1	FP32	Breaker address		R
0x007A	4	Imported active energy	FP64	Breaker address	4.000.000.000.000 Wh \triangleq 4.000.000.000 kWh	RW
0x007E	4	Exported active energy	FP64	Breaker address	4.000.000.000.000 Wh \triangleq 4.000.000.000 kWh	RW
0x0082	4	Imported reactive energy	FP64	Breaker address	4.000.000.000.000 Wh \triangleq 4.000.000.000 kWh	RW
0x0086	4	Exported reactive energy	FP64	Breaker address	4.000.000.000.000 Wh \triangleq 4.000.000.000 kWh	RW
0x0098	4	System time	U32 + U32	COM800 / COM100	ST	RW
0x00C6	1	Write protection	U8	COM800 / COM100	[0;1]	R
0x00CB	1	Breaker status and diagnostic data	U16	Breaker address	Bit 0: Molded case circuit breaker installed Bit 1: Molded case circuit breaker is part of breaker configuration Bit 2 ... 8: Reserved Bit 9: Limit violation Bit 10 ... 15: Reserved	R

Register address	Number of registers	Name	Format	Breaker address / COM800 / COM100	Value range	Access
0x00CE	2	COMx00 Status / ... / Diagnosis	U32	COM800 / COM100	Bit 0: Relevant parameter change Bit 1: Reserved Bit 2: Module slot 1 - firmware update Bit 3: Firmware data block available Bit 4: Bootloader update Bit 5 ... 7: Reserved Bit 8: Energy pulse overflow Bit 9: Limit has been violated Bit 10: Reserved Bit 11: Device restarted Bit 12 ... 15: Reserved Bit 16: Module slot 1 Bit 17: Test mode activated Bit 18 ... 23: Reserved Bit 22: Bootloader active Bit 24: No SNTP server synchronization message frame Bit 25 ... 27: Reserved Bit 28: Date and time of device Bit 29: Update mode Bit 30: Write protection Bit 31: Reserved	R

Register address	Number of registers	Name	Format	Breaker address / COM800 / COM100	Value range	Access
0x00D2	2	Protection function status	U32	Breaker address	Bit 0: System error Bit 1: Overload Bit 2: Overload N Bit 3 ... 6: Reserved Bit 7: Overtemperature Bit 8: Energy pulse overflow Bit 9: Application active Bit 10 ... 13: Reserved Bit 14 +15: ETU mode 0: Normal ETU operation 1: In bootloader mode 2: Protection function not active 3: Reserved Bit 16: ETU test active Bit 17: Test mode activated Bit 18: No calibration data Bit 19: Current transformer wire break Bit 20: Application error Bit 21: Bootloader error Bit 22: Device Parameter Set error Bit 23: Production data faulty or non-existent Bit 24: Rotary coding switch fault Bit 25: Connection error metering function Bit 26: EEPROM defective Bit 27: DPS defaults in use Bit 28: Current unbalance in excess of threshold value Bit 29 ... 31: Reserved	R

3.6 Available database

Register address	Number of registers	Name	Format	Breaker address / COM800 / COM100	Value range	Access
0x00D5	2	Status of metering function	U32	Breaker address	Bit 0 ... 7: Reserved Bit 8: Voltage unbalance in excess of threshold value Bit 9: Application active Bit 10 ... 27: Reserved Bit 28: Current unbalance in excess of threshold value Bit 29: Measuring range exceeded The accuracy of measured values can be outside the permissible tolerances stated in the operating instructions. Bit 30: Frequency outside permissible range	R
0x00D9	1	Status of 3VA molded case circuit breaker	U8	Breaker address	[0;255] 0000.0000 reserved 0000.1000 breaker ON 0000.0100 breaker OFF 0000.1100 breaker TRIP	R

Register address	Number of registers	Name	Format	Breaker address / COM800 / COM100	Value range	Access
0x00DA	1	Status of circuit breaker profile	U16	Breaker address	Bit 0: Limit reached Bit 1: An alarm is currently active Bit 2: Write protection Bit 3: Reserved Bit 4 ... 6: Reason for last trip Value: 0 = No trip 1 = Overload tripping (L) 2 = Instantaneous short circuit (I) 3 = Short-time delayed short circuit (S) 4 = Ground fault (G) 5 = Tripping operation as a result of extended protection function 6 = Overload in neutral conductor 7 = Reserved Bit 7: Load shedding alarm Bit 8 ... 9: Breaker position Value: 0 = Disconnected position 1 = Operating position 2 = Test position 3 = Breaker not available Bit 10 ... 11: Breaker status Value: 0 = Not ready 1 = OFF 2 = ON 3 = TRIP Bit 12: Reserved Bit 13: Reserved Bit 14: Spring energy store is compressed Bit 15: Overload alarm present	R
0x00DB	1	Number of I trips	U16	Breaker address	[0;255]	R
0x00DC	1	Number of S trips	U16	Breaker address	[0;255]	R
0x00DD	1	Number of L trips	U16	Breaker address	[0;255]	R
0x00DE	1	Number of N trips	U16	Breaker address	[0;255]	R

Functions

3.6 Available database

Register address	Number of registers	Name	Format	Breaker address / COM800 / COM100	Value range	Access
0x00DF	1	Number of G trips	U16	Breaker address	[0;255]	R
0x00E0	2	Number of temperature trips	FP32	Breaker address		R
0x00E2	1	Number of residual current trips	U16	Breaker address	[0;255]	R
0x00E4	1	Number of phase failure trips	U16	Breaker address	[0;255]	R
0x00E8	1	Number of all trips	U16	Breaker address	[0;65535]	R
0x00E9	2	Operating hours counter	U32	Breaker address	[0;4294967295]	R
0x00F8	2	Mechanical switching cycles	U32	Breaker address	[0;4294967295]	R
0x0100	2	Limit violation status	U32	Breaker address	Bit 0: Limit violation 0 Bit 1: Limit violation 1 Bit 2: Limit violation 2 Bit 3: Limit violation 3 Bit 4: Limit violation 4 Bit 5: Limit violation 5 Bit 6: Limit violation 6 Bit 7: Limit violation 7 Bit 8: Limit violation 8 Bit 9: Limit violation 9 Bit 10 ... 12: Reserved	R
0x0102	2	Alarm status	U32	Breaker address	[0;4294967295]	R
0x0200	6	Maximum current L1	FP32+TS	Breaker address		R
0x0206	6	Maximum current L2	FP32+TS	Breaker address		R
0x020C	6	Maximum current L3	FP32+TS	Breaker address		R
0x0212	6	Maximum neutral conductor current	FP32+TS	Breaker address		R
0x0218	6	Maximum ground fault current	FP32+TS	Breaker address		R
0x0230	6	Maximum 3-phase average current	FP32+TS	Breaker address		R
0x0236	6	Maximum current unbalance	FP32+TS	Breaker address		R
0x023C	6	Maximum voltage L1-N	FP32+TS	Breaker address		R
0x0242	6	Maximum voltage L2-N	FP32+TS	Breaker address		R
0x0248	6	Maximum voltage L3-N	FP32+TS	Breaker address		R
0x024E	6	Maximum voltage L1-L2	FP32+TS	Breaker address		R
0x0254	6	Maximum voltage L2-L3	FP32+TS	Breaker address		R
0x025A	6	Maximum voltage L3-L1	FP32+TS	Breaker address		R
0x0260	6	Maximum 3-phase average voltage L-N	FP32+TS	Breaker address		R

Register address	Number of registers	Name	Format	Breaker address / COM800 / COM100	Value range	Access
0x0266	6	Maximum 3-phase average voltage L-L	FP32+TS	Breaker address		R
0x026C	6	Maximum voltage unbalance	FP32+TS	Breaker address		R
0x0272	6	Maximum line frequency	FP32+TS	Breaker address		R
0x0278	6	Maximum active power L1	FP32+TS	Breaker address		R
0x027E	6	Maximum active power L2	FP32+TS	Breaker address		R
0x0284	6	Maximum active power L3	FP32+TS	Breaker address		R
0x028A	6	Maximum total active power	FP32+TS	Breaker address		R
0x0290	6	Maximum apparent power L1	FP32+TS	Breaker address		R
0x0296	6	Maximum apparent power L2	FP32+TS	Breaker address		R
0x029C	6	Maximum apparent power L3	FP32+TS	Breaker address		R
0x02A2	6	Maximum total apparent power	FP32+TS	Breaker address		R
0x02A8	6	Maximum total reactive power Q_{tot} L1	FP32+TS	Breaker address		R
0x02AE	6	Maximum total reactive power Q_{tot} L2	FP32+TS	Breaker address		R
0x02B4	6	Maximum total reactive power Q_{tot} L3	FP32+TS	Breaker address		R
0x02BA	6	Maximum total reactive power Q_{tot}	FP32+TS	Breaker address		R
0x02D8	6	Maximum power factor L1	FP32+TS	Breaker address		R
0x02DE	6	Maximum power factor L2	FP32+TS	Breaker address		R
0x02E4	6	Maximum power factor L3	FP32+TS	Breaker address		R
0x02EA	6	Maximum total power factor	FP32+TS	Breaker address		R
0x0302	6	Maximum THD current L1	FP32+TS	Breaker address		R
0x0308	6	Maximum THD current L2	FP32+TS	Breaker address		R
0x030E	6	Maximum THD current L3	FP32+TS	Breaker address		R
0x0314	6	Maximum THD voltage L1	FP32+TS	Breaker address		R
0x031A	6	Maximum THD voltage L2	FP32+TS	Breaker address		R
0x0320	6	Maximum THD voltage L3	FP32+TS	Breaker address		R
0x0326	6	Maximum THD voltage L1-L2	FP32+TS	Breaker address		R
0x032C	6	Maximum THD voltage b-c L2-L3	FP32+TS	Breaker address		R
0x0332	6	Maximum THD voltage L3-L1	FP32+TS	Breaker address		R
0x0400	6	Minimum current L1	FP32+TS	Breaker address		R

3.6 Available database

Register address	Number of registers	Name	Format	Breaker address / COM800 / COM100	Value range	Access
0x0406	6	Minimum current L2	FP32+TS	Breaker address		R
0x040C	6	Minimum current L3	FP32+TS	Breaker address		R
0x0412	6	Minimum neutral conductor current	FP32+TS	Breaker address		R
0x0418	6	Minimum ground fault current	FP32+TS	Breaker address		R
0x0430	6	Minimum 3-phase average current	FP32+TS	Breaker address		R
0x0436	6	Minimum current unbalance	FP32+TS	Breaker address		R
0x043C	6	Minimum voltage L1-N	FP32+TS	Breaker address		R
0x0442	6	Minimum voltage L2-N	FP32+TS	Breaker address		R
0x0448	6	Minimum voltage L3-N	FP32+TS	Breaker address		R
0x044E	6	Minimum voltage L1-L2	FP32+TS	Breaker address		R
0x0454	6	Minimum voltage L2-L3	FP32+TS	Breaker address		R
0x045A	6	Minimum voltage L3-L1	FP32+TS	Breaker address		R
0x0460	6	Minimum 3-phase average voltage L-N	FP32+TS	Breaker address		R
0x0466	6	Minimum 3-phase average voltage L-L	FP32+TS	Breaker address		R
0x046C	6	Minimum voltage unbalance	FP32+TS	Breaker address		R
0x0472	6	Minimum line frequency	FP32+TS	Breaker address		R
0x0478	6	Minimum active power L1	FP32+TS	Breaker address		R
0x047E	6	Minimum active power L2	FP32+TS	Breaker address		R
0x0484	6	Minimum active power L3	FP32+TS	Breaker address		R
0x048A	6	Minimum total active power	FP32+TS	Breaker address		R
0x0490	6	Minimum apparent power L1	FP32+TS	Breaker address		R
0x0496	6	Minimum apparent power L2	FP32+TS	Breaker address		R
0x049C	6	Minimum apparent power L3	FP32+TS	Breaker address		R
0x04A2	6	Minimum total apparent power	FP32+TS	Breaker address		R
0x04A8	6	Minimum total reactive power Q_{tot} L1	FP32+TS	Breaker address		R
0x04AE	6	Minimum total reactive power Q_{tot} L2	FP32+TS	Breaker address		R
0x04B4	6	Minimum total reactive power Q_{tot} L3	FP32+TS	Breaker address		R
0x04BA	6	Minimum total reactive power Q_{tot}	FP32+TS	Breaker address		R

Register address	Number of registers	Name	Format	Breaker address / COM800 / COM100	Value range	Access
0x04D8	6	Minimum power factor L1	FP32+TS	Breaker address		R
0x04DE	6	Minimum power factor L2	FP32+TS	Breaker address		R
0x04E4	6	Minimum power factor L3	FP32+TS	Breaker address		R
0x04EA	6	Minimum total power factor	FP32+TS	Breaker address		R
0x0502	6	Minimum THD current L1	FP32+TS	Breaker address		R
0x0508	6	Minimum THD current L2	FP32+TS	Breaker address		R
0x050E	6	Minimum THD current L3	FP32+TS	Breaker address		R
0x0514	6	Minimum THD voltage L1	FP32+TS	Breaker address		R
0x051A	6	Minimum THD voltage L2	FP32+TS	Breaker address		R
0x0520	6	Minimum THD voltage L3	FP32+TS	Breaker address		R
0x0526	6	Minimum THD voltage L1-L2	FP32+TS	Breaker address		R
0x052C	6	Minimum THD voltage L2-L3	FP32+TS	Breaker address		R
0x0532	6	Minimum THD voltage L3-L1	FP32+TS	Breaker address		
0x4268	2	COM800 supply voltage [V]	FP32	COM800 / COM100		R
0x426A	2	COM060 supply voltage [V]	FP32	COM800 / COM100		R
0x426C	6	Maximum COM800 supply voltage [V]	FP32+TS	COM800 / COM100		R
0x4272	6	COM060 maximum supply voltage	FP32+TS	COM800 / COM100		R
0x4278	6	Minimum COM800 supply voltage [V]	FP32+TS	COM800 / COM100		R
0x427E	6	Minimum COM060 supply voltage [V]	FP32+TS	COM800 / COM100		R
0x4400	4	Time stamp of the last period	TS	Breaker address		R
0x4404	2	Actual length of the last period [ms]	U32	Breaker address	[0;3600000]	R
0x4406	2	Mean apparent power in the last period [W]	FP32	Breaker address		R
0x4408	2	Mean active power import in the last period [var]	FP32	Breaker address		R
0x440A	2	Mean reactive power import in the last period	FP32	Breaker address		R
0x440C	2	Mean active power export in the last period [W]	FP32	Breaker address		R
0x440E	2	Mean reactive power export in the last period [var]	FP32	Breaker address		R
0x4410	2	Apparent power in the last period [W]	FP32	Breaker address		R

Functions

3.6 Available database

Register address	Number of registers	Name	Format	Breaker address / COM800 / COM100	Value range	Access
0x4412	2	Active power import in the last period [W]	FP32	Breaker address		R
0x4414	2	Reactive power import in the last period [var]	FP32	Breaker address		R
0x4416	2	Active power export in the last period [W]	FP32	Breaker address		R
0x4418	2	Reactive power export in the last period [var]	FP32	Breaker address		R
0x441A	2	Maximum apparent power in the last period [VA]	FP32	Breaker address		R
0x441C	2	Minimum apparent power in the last period [VA]	FP32	Breaker address		R
0x441E	2	Maximum active power in the last period [W]	FP32	Breaker address		R
0x4420	2	Minimum active power in the last period [W]	FP32	Breaker address		R
0x4422	2	Maximum reactive power in the last period [var]	FP32	Breaker address		R
0x4424	2	Minimum reactive power in the last period [var]	FP32	Breaker address		R
0x4426	2	Time since the start of the present period [s]	U32	Breaker address	[0;3600]	R
0x4428	2	Apparent power export in the present period [VA]	FP32	Breaker address		R
0x442A	2	Active power import in the present period [W]	FP32	Breaker address		R
0x442C	2	Reactive power import in the present period [var]	FP32	Breaker address		R
0x442E	2	Active power export in the present period [W]	FP32	Breaker address		R
0x4430	2	Reactive power export in the present period [var]	FP32	Breaker address		R
0x4432	2	Maximum apparent power in the present period [VA]	FP32	Breaker address		R
0x4434	2	Minimum apparent power in the present period [VA]	FP32	Breaker address		R
0x4436	2	Maximum active power in the present period [W]	FP32	Breaker address		R
0x4438	2	Minimum active power in the present period [W]	FP32	Breaker address		R
0x443A	2	Maximum reactive power in the present period [var]	FP32	Breaker address		R
0x443C	2	Minimum reactive power in the present period [var]	FP32	Breaker address		R
0x4BFE	2	Operating hours counter [s]	U32	COM800 / COM100	[0;999999999]	R

Register address	Number of registers	Name	Format	Breaker address / COM800 / COM100	Value range	Access
0x516C	1	EFB inputs and outputs	U16	Breaker address	Bit 0: ZSI input signal Bit 1: Digital input Bit 2: Confirmation by user Bit 3: Test mode Bit 4 ... 6: Fault Value: 0 = No error 1 = Communication error 2 = Hardware fault within EFB 3 = Current overload Bit 7: Reserved Bit 8: ZSI output signal Bit 9: Digital output 0 Bit 10: Digital output 1 Bit 11: Digital output 2 Bit 12: Digital output 3 Bit 13 ... 15: Reserved	R
0x5174	1	Draw-out unit available	U16	Breaker address	0 = Not available 1 = Available	R
0x5175	1	Draw-out unit: Status	U16	Breaker address	Bit 0: Wire break (connection) Bit 1: Reserved (connection) Bit 2: Open (connection) Bit 3: Closed (connection) Bit 4: Wire break (test) Bit 5: Reserved (test) Bit 6: Open (test) Bit 7: Closed (test) Bit 8: Wire break (interruption) Bit 9: Reserved (interruption) Bit 10: Open (interruption) Bit 11: Closed (interruption) Bit 12 ... 15: Reserved	R

3.6 Available database

Register address	Number of registers	Name	Format	Breaker address / COM800 / COM100	Value range	Access
0x517B	1	RCD status (IEC only)	U16	Breaker address	Bit 0: Alarm level 1 for residual current Bit 1: Alarm level 2 for residual current Bit 2: Internal supply Bit 3: External supply Bit 4: Maglatch unlatched Bit 5: Fault Bit 6 ... 8: Reserved Bit 9: Tripped Bit 10: Test trip via trip button on device Bit 11: Test trip via electrical contact Bit 12: Test trip via communication channel Bit 13 ... 15: Reserved	R
0x9C5E	1	Switching of the SEO	U16	Breaker address	2069: Initiate switch-on 2070: Initiate switch-off 2071: Acknowledge SEO	

Register address	Number of registers	Name	Format	Breaker address / COM800 / COM100	Value range	Access
0x5179	1	Status of the SEO	U16	Breaker address	Bits 0-7: Reserved bits must be zero Bit 8: Operator on state: 0 = Spring discharged 1 = Spring charged Bit 9: Operator off state: 0 = Spring discharged 1 = Spring charged Bits 10-11: Operation mode 0 = locked 1 = manual 2 = automatic 3 = defect Bits 12-13: Reset mode 0 = automatic reset 1 = manual or autom. reset 2 = remote operation 3 = error Bit 14: Error state 0 = no error 1 = error Bit 15: acknowledge state 0 = acknowledge was carried out 1 = acknowledge is pending	
0xF9E1	1	3VA-line: Status	U16	COM800 / COM100	Bit 0: Configuration is set Bit 1: Configuration is valid Bit 2: At least one known breaker cannot be accessed Bit 3: At least one known breaker is connected Bit 4: Too many breakers connected Bit 5 ... 15: Reserved	R

*) The system time and time stamp use the same format based on 2 x U32
 1. U32: Number of seconds since January 1, 1970, without leap seconds. This corresponds to UNIX time
 2. U32: Fractions of current second, i.e. 2⁻³² seconds or about 4 millions of a second.

Application examples

The power distribution network can be integrated into the production or building automation system or implemented as a separate, autonomous information system via communication. The following application scenarios will be analyzed in this chapter:

- **Totally Integrated Automation (TIA)** for production plants
- **Total Building Solutions (TBS)** for utility buildings
- **Totally Integrated Power (TIP)** for the power distribution systems of the two applications mentioned above
- Power management with powermanager

In addition to coordinated power distribution equipment in all phases and levels, TIP also offers a standardized information and communication structure.

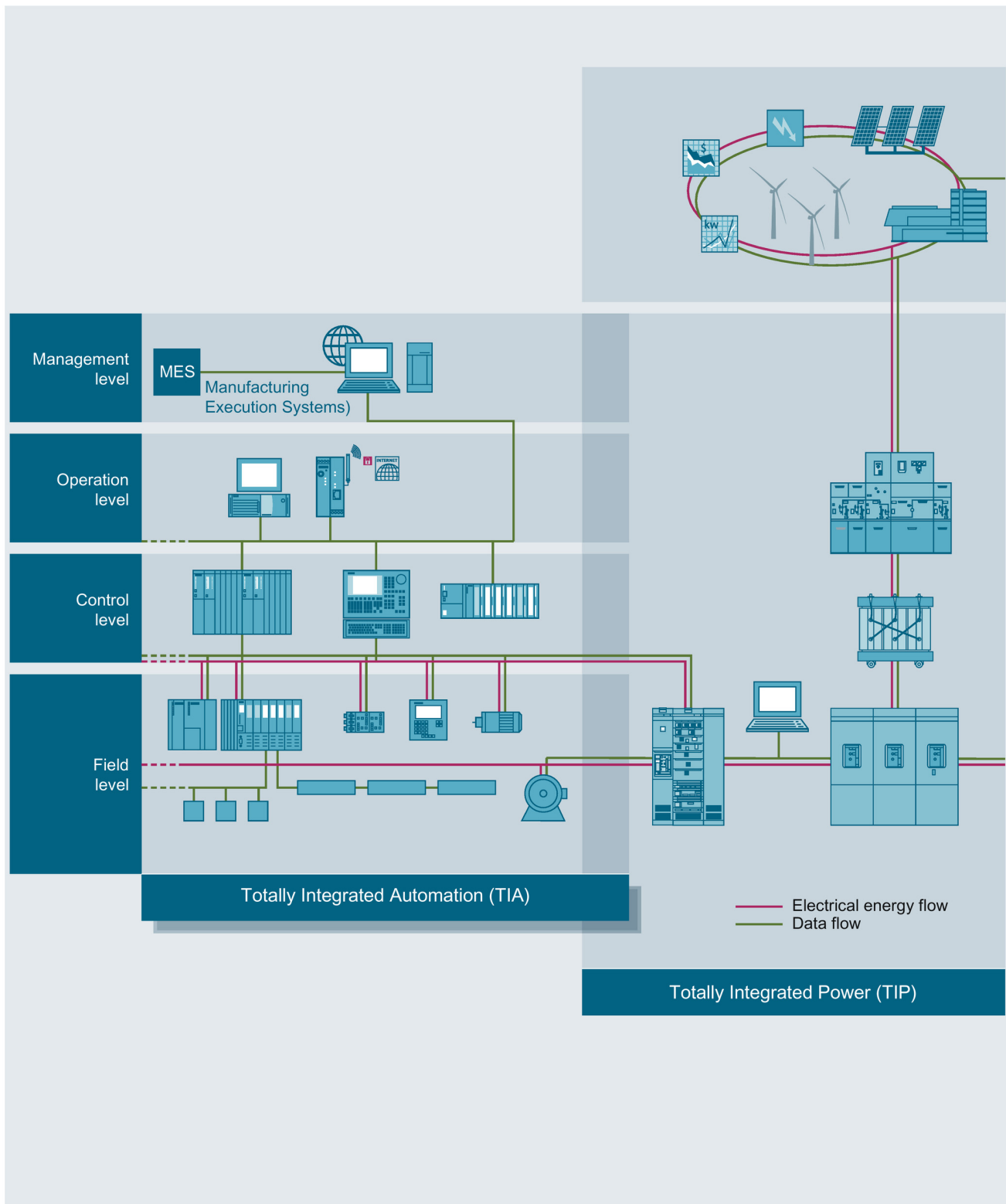

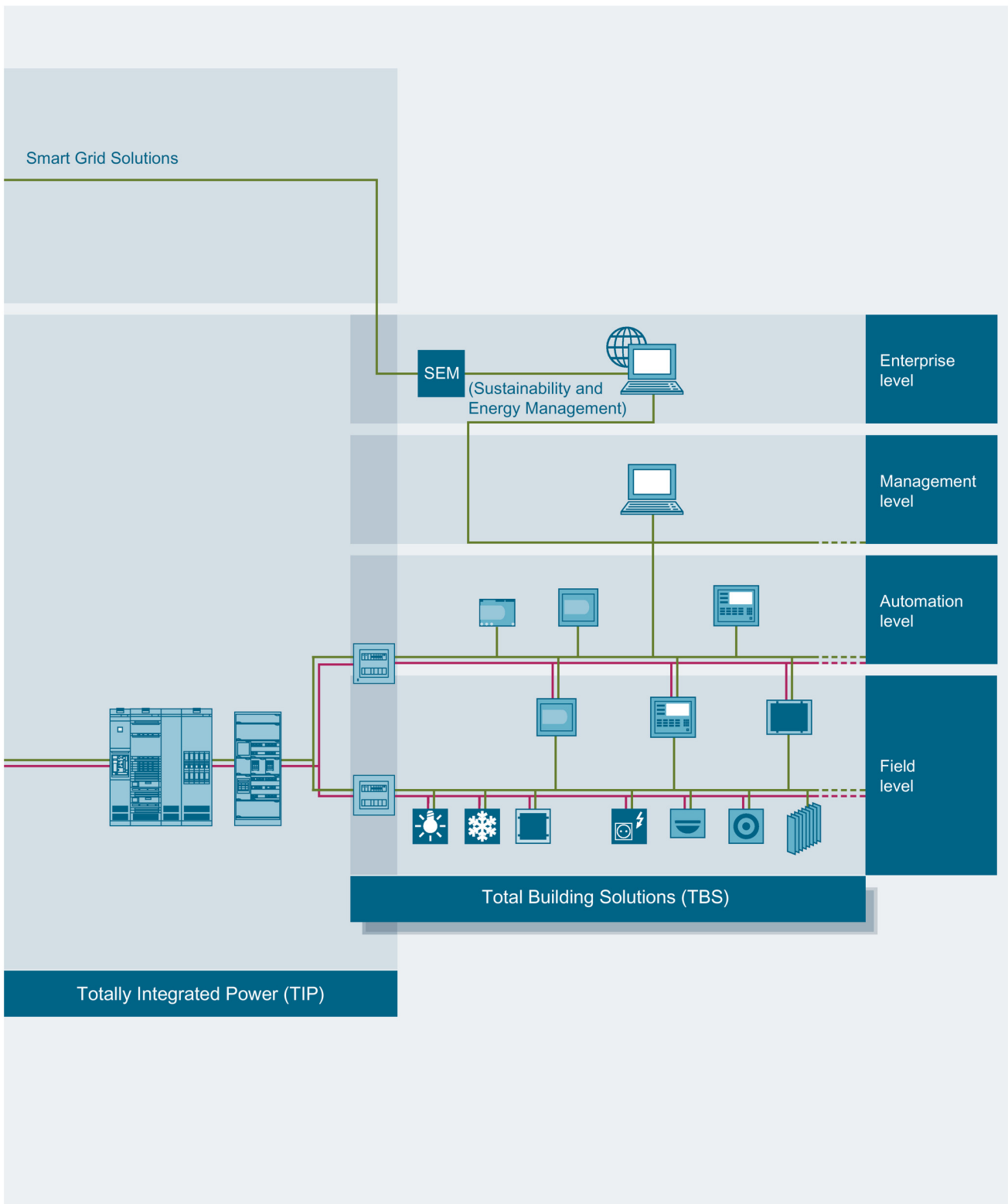

3VA molded case circuit breakers with ETUs 5-series and 8-series use communication systems to deliver important information in power distribution systems.

The following information is available for power and line monitoring:

- Actual measured values
- Status and maintenance information

These large volumes of information can be used for the following applications:

- Power monitoring, e.g. cost center management
- Process and factory automation
- Building management
- Maintenance management, with diagnostics and fault localization

Commissioning and maintenance

Examples of information that can be retrieved when commissioning or maintenance is in progress:

- Setting values for protection parameters
- Test functions
- Status and diagnostic information
- Trip history and operational events

Siemens offers the software application powerconfig (<http://support.automation.siemens.com/WW/view/en/63452759>) for commissioning and maintenance.

powerconfig is a parameterization, testing and commissioning application designed for use with the following circuit breakers and measuring devices:

- Communication-capable 3VA molded case circuit breakers with appropriate ETUs
- 3WL air circuit breakers with appropriate ETUs
- 3VL molded case circuit breakers with appropriate ETUs
- 7KM PAC5100 / 5200 measuring device
- 7KM PAC4200 measuring device
- 7KM PAC3200 measuring device
- 7KM PAC3100 measuring device
- 7KT PAC1500 measuring device
- ATC5300 automatic transfer control device

powerconfig can be downloaded (<http://support.automation.siemens.com/WW/view/en/63452759>) free of charge.

To be able to connect with a device, powerconfig requires a Windows-based PC*) and one of the communication networks described in chapter System description (Page 17).

*) For the precise requirements, please refer to the latest product information at Siemens Industry Online Support (<https://support.industry.siemens.com/cs/ww/en/ps>).

For additional information about powerconfig, please refer to chapter Commissioning and service software: powerconfig (Page 38).

4.1 Power monitoring with powermanager

Siemens has developed the powermanager software for power and line monitoring

Identifying cost-cutting potential

The powermanager power monitoring software processes and monitors the measured data obtained from 7KT/7KM PAC measuring devices and communication-capable 3WL/ 3VA / 3VL circuit breakers. Potential energy savings can easily be identified thanks to the transparency of the energy flows.

The entire SENTRON portfolio with power monitoring software, measuring devices and circuit breakers has been certified by the TÜV Rheinland for its suitability to support a power management system in accordance with ISO 50001.

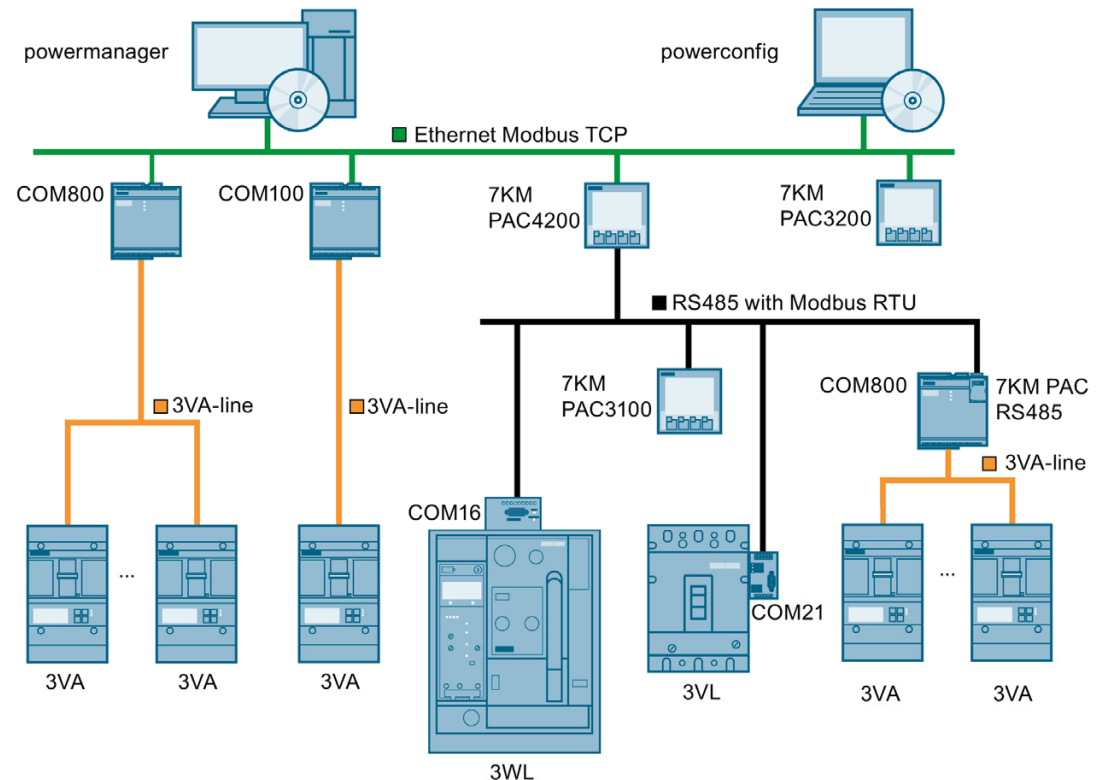

4.1.1 Application

The power monitoring software "powermanager" is used to acquire, monitor, evaluate, display and archive power data from 7KM PAC1500, 7KM PAC3100, 7KM PAC3200, 7KM PAC4200, 7KM PAC5100 / 5200 measuring devices, 3WL, 3VL and 3VA circuit breakers and any Modbus-enabled measuring devices.

powermanager offers the following power monitoring functions:

- Tree view of the customer's system (project tree)
- Measured value display with pre-defined user views
- Alarm management
- Demand curve
- Reporting, different report types, e.g. cost center report
- Load monitoring
- Reaction plans
- Power peak analysis
- Support of distributed estates (systems)
- Archiving system
- User administration

4.1.2 Multi-language capability

Powermanager V3.2 or higher comes with support for eight languages:

- German
- English
- French
- Italian
- Spanish
- Portuguese
- Turkish
- Chinese

Windows, dialogs and the designations of measured variables used in the standard version are displayed in these languages.

An experimental version (<http://support.automation.siemens.com/WW/view/en/51591062>) can be downloaded directly from the Internet.

4.2 Automation technology

Solutions for the process and manufacturing industries with Totally Integrated Automation (TIA)

Totally Integrated Automation, the industrial automation solution developed by Siemens, supports the efficient automation of a broad range of processes. Standardized interfaces, in particular communication interfaces, help to ensure effective interaction between all components.

A salient feature of the process and manufacturing industries is their high power consumption. The integration of power data and the status of the power distribution network into existing systems is therefore a logical step forward.

In the SIMATIC or TIA environment combinations of devices and software are offered which are capable of measuring energy. SIMATIC Energy Suite in STEP 7 and WinCC (TIA Portal). With the components of SIMATIC Energy Suite, referred to in the following as Energy Suite, you already integrate central tasks of energy management at your automation system level. Configuration takes place easily and conveniently directly in TIA Portal (STEP 7 and WinCC). Energy Suite acquires, archives and makes the energy data available in the CPU in standardized form. You can then visualize and use the energy data in your automation program (e.g. for monitoring purposes).

Template pictures and picture elements are available in Siemens Industry Online Support for the visual indication of the acquired energy data in WinCC Professional or in WinCC Basic, Comfort or Advanced. In addition, you can further process the energy data in SIMATIC Energy Manager PRO:

- For key data calculation, for example, energy costs per produced unit, annual CO² emission
- For the user-friendly compilation of energy reports, for example, to optimize energy purchasing

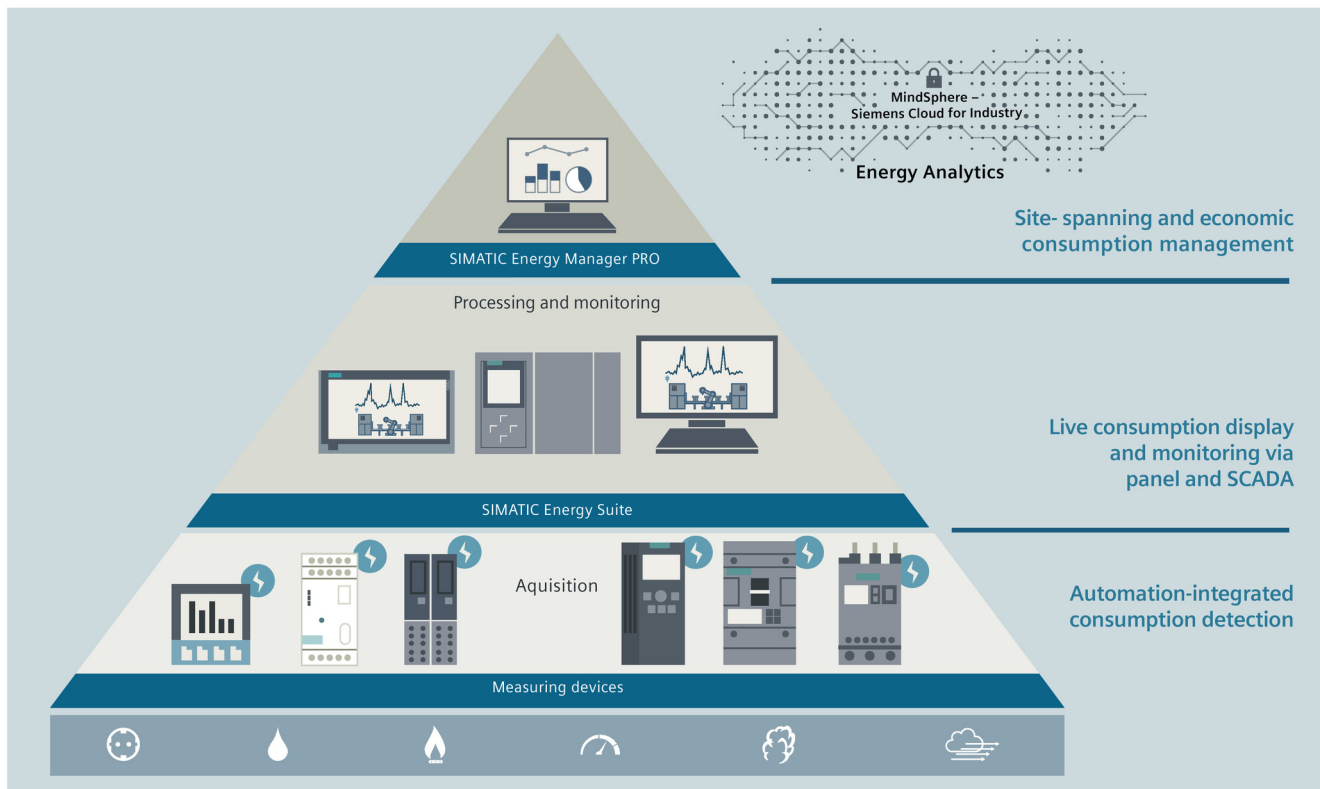

The 3VA molded case circuit breaker can also be integrated into the configuration via PROFINET IO.

PROFINET and PROFlenergy

An increasing number of devices in automation technology offer PROFINET. A 7KM PAC Switched Ethernet PROFINET expansion module is also available for 3VA molded case circuit breakers and 7KM PAC3200 and 7KM PAC4200 measuring devices.

PROFlenergy is a "Common Application Profile" developed by Profibus International. PROFlenergy makes it possible to retrieve power data via a standardized interface.

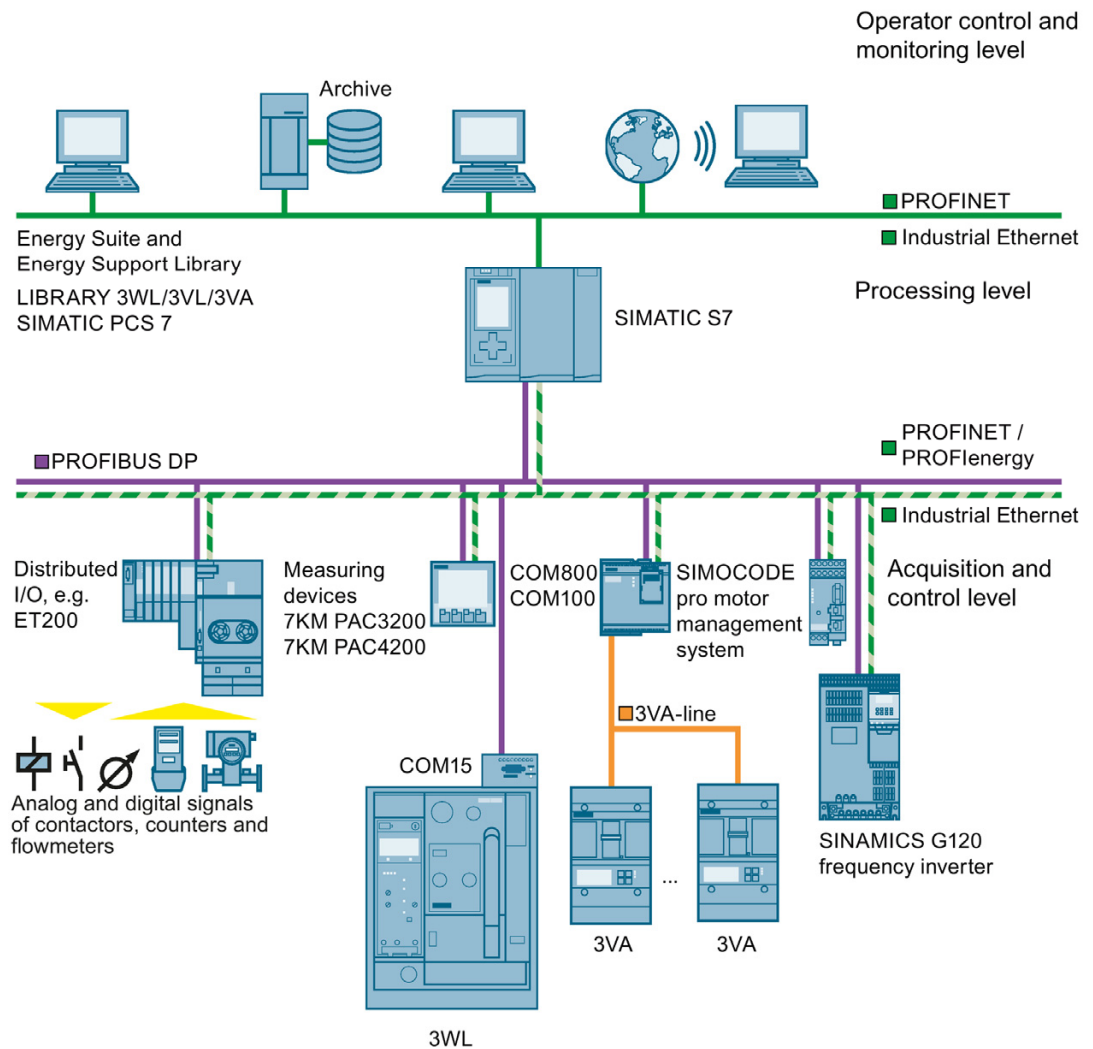

Communication via PROFIBUS DP

PROFIBUS DP enables integration of a wide range of devices:

- Protection devices such as 3WL, 3VA circuit breakers for power distribution equipment and loads
- Equipment for the open-loop and closed-loop control of electricity, such as frequency converters, motor management systems and soft starters
- Equipment for measuring power:
 - electrical measured variables: e.g. via the 7KM PAC3200 / 4200 measuring devices
 - non-electrical measured variables: via analog/digital converters

4.3 Building automation

Intelligent buildings with Total Building Solutions

Modern buildings need to satisfy many different criteria. Building services with integrated disciplines such as building automation, fire safety, security, lighting, and low-voltage power distribution form the core of a total building solution. The objective of a total building solution is to achieve optimum integration of these disciplines in order to make buildings safer, more comfortable, more economical and more efficient.

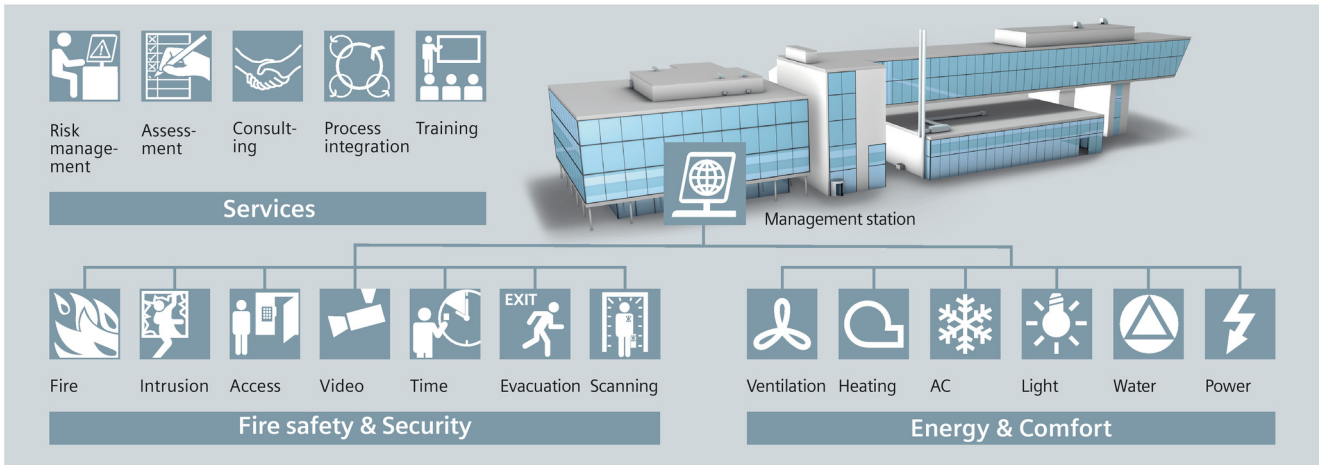

3VA molded case circuit breakers are particularly helpful in meeting power consumption and comfort targets and should be incorporated via a communication interface into the building automation system of the total building solution design.

Connection, commissioning, operation

This chapter describes in detail how a communication network of 3VA molded case circuit breakers can be created.

5.1 Application planning

The following issues need to be clarified before a communication network can be set up in a power distribution system:

- Installation location
- Supply voltage and grounding system
- Heat loss calculation
- Climatic operating environments
- Communication network planning

This chapter gives instructions on how to plan communication networks and explains what factors need to be taken into account in order to make optimum use of the communication capability of 3VA molded case circuit breakers.

5.1.1 Installation locations

To be able to make full use of all the communication functions provided by 3VA molded case circuit breakers, it is first important to plan the precise installation location of the components in the power distribution system. To ensure that sufficient space is available for individual components and their connections, this chapter provides an overview of space requirements and gives recommendations as to how components should be installed.

Note**DIN rail**

DIN rail type DIN EN 60715 - TH35 – 7.5 / TH 35 – 15 may be used to mount the COM800/COM100 breaker data server and the EFB300 external function box.

COM800 / COM100 breaker data server

The following space requirements must be calculated for the COM800 / COM100 breaker data server:

- Width 90 mm [3.5 in]
- Height 114 mm [4.5 in]
- Depth 34 mm [1.3 in] without and 56 mm [2.2 in] with 7KM expansion module

Space must also be provided above the COM800 / COM100 breaker data server for:

- the connections
- the Ethernet connector
- the 24 V supply
- the connector for the 3VA-line

You can find additional information in chapters Connecting PROFIBUS DP (Page 155) and Connecting Switched Ethernet PROFINET (Page 177).

EFB300 external function box

The following space requirements must be calculated for the EFB300 external function box:

- Width 70 mm [2.7 in]
- Height 117 mm [4.6 in] incl. connections
- Depth 33 mm [1.2 in]

The external function box can also be mounted directly on a wall. You can find additional information in the operating instructions for the EFB300 external function box.

<http://support.automation.siemens.com/WW/view/en/80600828>

COM060 communication module

The COM060 communication module is installed in the right-hand accessories compartment of the 3VA molded case circuit breaker. The communication module occupies four slots which are then no longer available for other accessories. The ambient conditions for the 3VA molded case circuit breaker are not altered as a result of installing the COM060 communication module.

DSP800 display

The DSP800 display is intended for installation in permanently installed distribution equipment and control cabinets within closed rooms.

Note

The DSP800 display requires installation of a COM800 or COM100 breaker data server.

TD500 test device

The TD500 test device can be attached by a magnet holder to a steel plate (e.g. on the distribution equipment door).

Please note the following:

- The connecting cable (1.5 m) supplied with the device determines the cable length between the TD500 test device and the 3VA molded case circuit breaker.
- TD500 must be supplied by the plug-in power pack shipped with the device.
- TD500 is operated by buttons which must be accessible.
- TD500 can be connected to the PC by means of a USB cable (1.5 m).

Note

The TD500 may only be connected to and operated with a 3VA molded case circuit breaker that is disconnected from the power supply.

5.1.2 Supply voltages and grounding system

The 3VA molded case circuit breaker can be supplied with voltage from various sources depending on the required scope of functions.

The ETU protection function is supplied from the main circuit.

Status, control, test, metering and communications functions as well as the LCD must be connected to an additional auxiliary power supply. This ensures that these functions will be available even when the main circuit is de-energized.

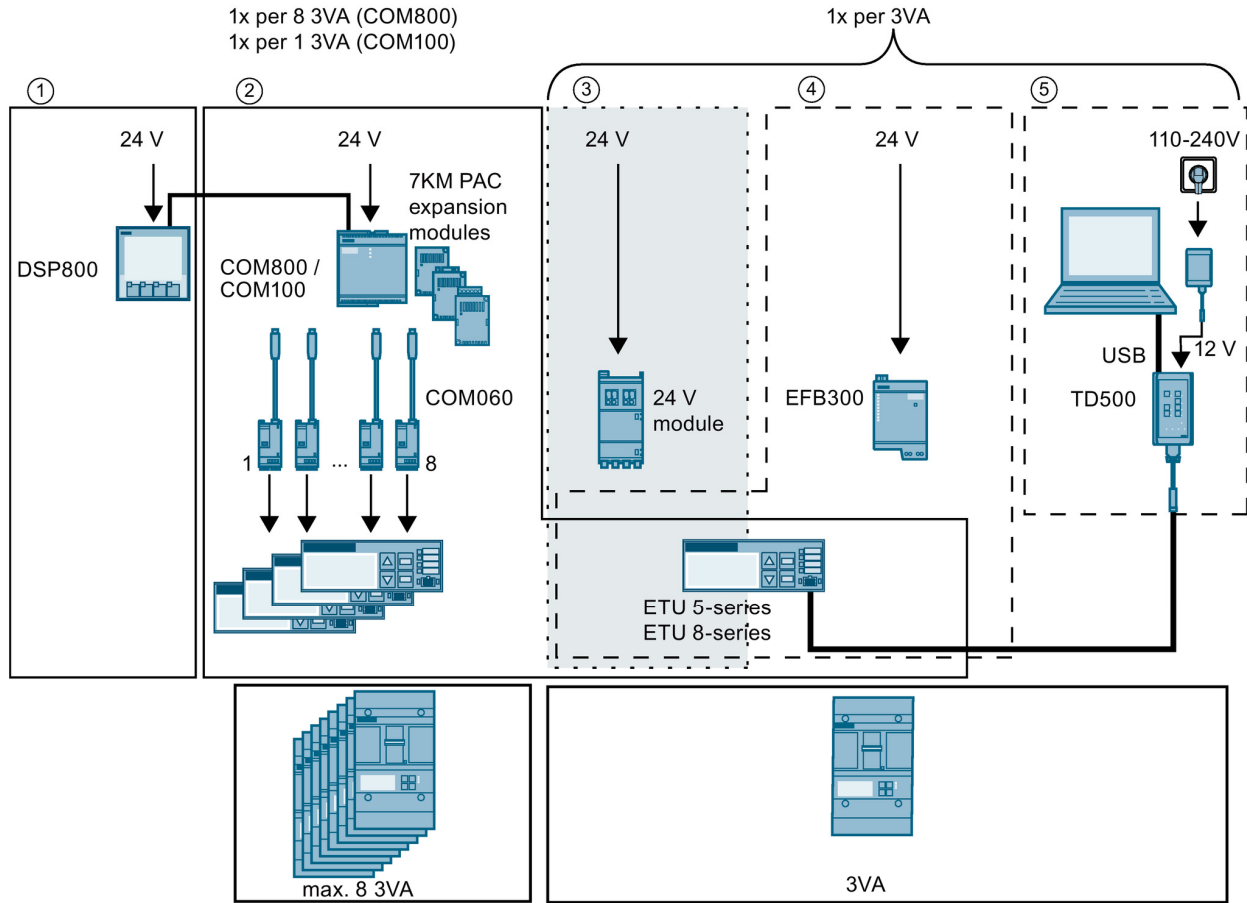

	Function	Supply via	Voltage	Tolerance	Protection class	Current max.	Making current	Power losses
①	Local display via DSP	DSP800	24 V DC	± 20 %	SELV/ PELV	90 mA		2.2 W
②	Measurement and communication & local display and operation ¹⁾	COM800 breaker data server	24 V DC	± 20 %	SELV / PELV	1120 mA	2000 mA	27 W
		COM100 breaker data server	24 V DC	± 20 %	SELV / PELV	350 mA		7.5 W
③	Measurement with local display and operation	24 V module	24 V DC	± 20 %	SELV / PELV	100 mA		2.5 W
④	Switching of digital inputs / outputs & measurement with local display and operation ¹⁾	EFB300 external function box	24 V DC	± 20 %	SELV / PELV	80 mA		2.0 W
⑤	Testing	TD500 test device	110 - 240 V AC	± 3 %				2.5 W

24 V DC Direct current

The DC supply must comply with the requirements defined in IEC 61558 or Class 2 according to UL 1310. The residual ripple must be limited to < 250 mVpp. We therefore recommend use of a power supply from the SITOP product range.

- 1) If both COM800 / COM100 ② and EFB300 ④ are to be used on a 3VA molded case circuit breaker, both COM800 / COM100 and EFB300 must be supplied with voltage. It is recommended to connect both power supplies with a common functional ground.

5.1.3 Heat loss calculation of the communication components

In order to calculate the total heat loss, the heat losses of each individual component installed must be added up.

5.1.4 Ambient conditions

The electronic components of the 3VA molded case circuit breaker can operate in the following ambient conditions:

Ambient conditions		
Operating temperature	[° C]	-25 .. +70
Storage temperature	[° C]	-40 .. +80
Relative humidity		≤ 95 %
Altitude	For altitudes of ≤ 2000 m above sea level without restriction to ratings.	

5.1.5 Communication network planning

The 3VA molded case circuit breaker combined with the COM800 / COM100 breaker data server and optional communication modules is a:

- PROFINET IO device
- PROFIBUS DP slave
- Modbus TCP slave
- Modbus RTU slave

IP network planning is required for Modbus TCP and PROFINET IO.

The network planning, particularly of the free IP addresses, must be completed before the COM800 / COM100 breaker data server and the optional communication modules are commissioned.

The IP address of the DSP800, the assigned COM800 / COM100 and the IP address of the PC with powerconfig must be taken into account when planning a network with DSP800.

An example of simple IP address assignment is:

- PC with powerconfig 192.168.0.1
- COM800 or COM100 192.168.0.2
- DSP800 192.168.0.3

For all devices

- Subnet mask 255.255.255.0 or 255.255.0.0; i.e. the "0"s mark the relevant positions for the device address.
- Gateway 0. 0. 0.0

When the PROFIBUS DP protocol is used, it is only necessary to specify the network address. The baud rate and character frame are automatically detected or predefined.

On RS 485 networks, the specifications of the Modbus master for addresses, data transfer rate, character frame with parity and, possibly, response times, must be adopted and set with powerconfig.

Further information

You can find further information about PROFIBUS and PROFINET at:

- PROFIBUS and PROFINET documentation from PI International
<http://www.profibus.com> (<http://www.profibus.com>)
- PROFenergy profile
<http://www.profibus.com/nc/downloads/downloads/commonapplication-profile-profienergy/display>
(<http://www.profibus.com/nc/downloads/downloads/commonapplication-profile-profienergy/display>)
- SIMATIC NET "PROFIBUS Network Manual"
- Modbus-IDA.org "MODBUS APPLICATION PROTOCOL SPECIFICATION V1.1a"
- MODBUS.org "MODBUS over Serial Line Specification & Implementation Guide V1.02"

You can find the latest guides at:

- Ethernet: <http://support.automation.siemens.com/WW/view/en/27069465>
(<http://support.automation.siemens.com/WW/view/en/27069465>)
- PROFIBUS: <http://support.automation.siemens.com/WW/view/en/35222591>
(<http://support.automation.siemens.com/WW/view/en/35222591>)

The communication infrastructure is already defined in many cases and must be applied appropriately to the 3VA molded case circuit breakers.

5.2 COM800 / COM100 breaker data server

The COM800 / COM100 breaker data server provides the following functions:

- Parameterization and diagnosis of the COM800 / COM100 breaker data server itself
- Communication with the power monitoring system powermanager V3.x or other software available on the market
- Configuration of the COM800 / COM100 breaker data server and the connected 3VA molded case circuit breakers with the powerconfig software
- Communication with the DSP800 display
- Updating of firmware of the COM800 / COM100 breaker data server, the connected COM060 and the PROFIBUS DPV1 expansion module with powerconfig (see Firmware update (Page 245))

This chapter gives instructions on how to connect up and use the COM800 / COM100 breaker data server. For information about installation, please refer to the Operating Instructions (<http://support.automation.siemens.com/WW/view/en/80601362>).

5.2.1 Connecting

5.2.1.1 Connecting the 24 V supply

The 24 V DC supply is connected to the COM800 / COM100 breaker data server via terminal X1. This 24 V DC supply also feeds the connected 3VA molded case circuit breakers.

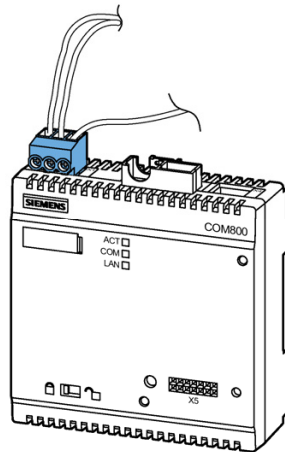

The functional ground must be connected to terminal X1 of the COM800 / COM100 breaker data server (if possible, at the same potential as the shield of the communication network).

5.2.1.2 Connecting the 3VA-line

The COM800 / COM100 breaker data server is equipped with two terminals for making the 3VA-line connection.

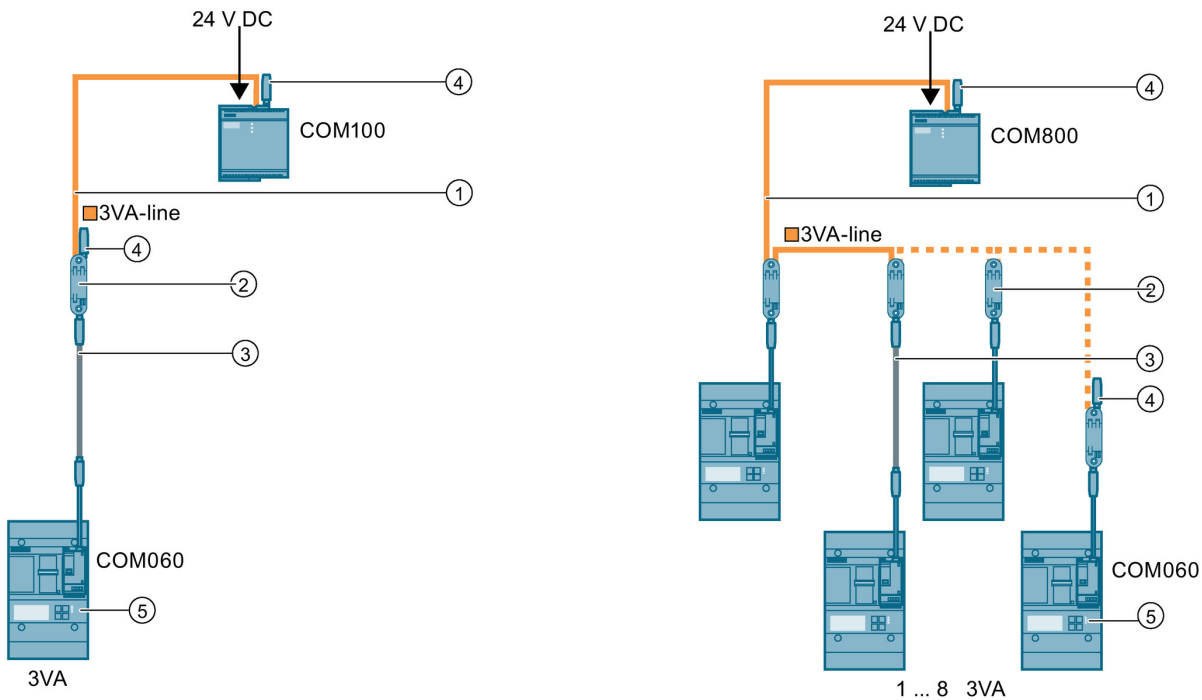

- ① Pre-assembled connecting cable T-connector
- ② T-connector
- ③ Pre-assembled connecting cable for extending the COM060-to-T-connector spur line connection
- ④ Terminating resistor

The connection sockets at the two ends of the 3VA-line must be equipped with terminating resistors.

Note

The total length of all cables must not exceed **20 m** and the number of 8 T-connectors must not be exceeded. The cables may be extended using T-connectors within the scope of the previously named conditions.

The 3VA-line comprises up to 8 connecting cables, up to 8 T-connectors and 2 terminating resistors to allow connection of up to 8 3VA molded case circuit breakers with the COM800 breaker data server.

For a COM100 breaker data server, the 3VA-line consists of a connecting cable, a T-connector and two terminating resistors.

The T-connectors link two connecting cables to a COM060 communication module. The two furthest distant ends of the 3VA-line must be equipped with a terminating resistor.

5.2.1.3 Ethernet connection

The COM800 / COM100 breaker data server is equipped with an Ethernet interface with the following properties:

- Transmission rates 10 / 100 Mbit/s
- RJ45 socket on the top of the device for RJ45 connector with EIA/TIA T568B assignment
- Cable type 100Base-TX (CAT5)

The Ethernet cable must be grounded for data transmission according to the Fast Ethernet standard. You can find information on grounding in Chapter Connection (Page 108).

- Autonegotiation
- MDI-X auto crossover
- Communication over Modbus TCP

NOTICE

Interference with other network nodes due to incorrect network settings
--

Incorrect network settings can adversely affect or interfere with the functions of other network nodes. The network settings for Ethernet are defined by the system administrator and must be set accordingly on the device.
--

If the settings are not known, the (Ethernet) cable must not be connected.
--

Autonegotiation

Autonegotiation is a method used by network communication peers to automatically negotiate the highest possible transmission rate. If the communication partner does not support autonegotiation, the COM800 / COM100 breaker data server adjusts automatically to the transmission rate of the communication partner.

5.2.1.4 Connecting the module interface

Either the 7KM PAC PROFIBUS DP, 7KM PAC Switched Ethernet PROFINET, or 7KM PAC RS 485 expansion module can be installed in the COM800 / COM100 breaker data server.

Install the expansion module before you commission the COM800 breaker data server.

Observe the ESD guidelines.

NOTICE

Non-functioning connector at the 7KM PAC expansion module

Dirty or bent pins can affect the function of the connectors. The connectors can be damaged.

Ensure the following:

- There are no metal parts between the pins.
- There are no metal parts stuck to the pins.
- Do not bend the pins.
- Do not touch the pins.
- Keep the pins clean

Connecting the module to the module interface

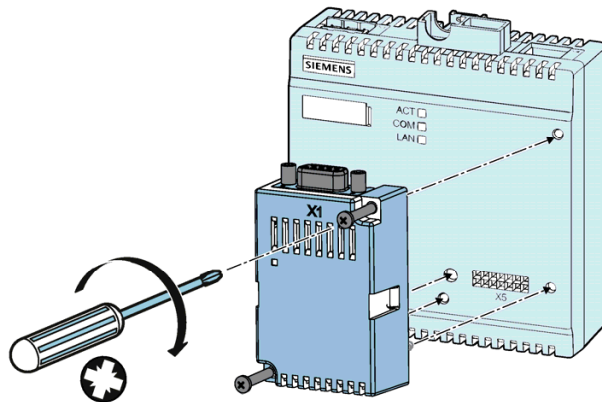

1. Ensure safe isolation from supply.
2. Make sure that you do not transfer any static charges to the device. Discharge the static electricity from your body before you touch the device.
3. Handle the 7KM PAC expansion module by its plastic housing only.
4. Attach the 7KM PAC expansion module to the COM800 / COM100. The guide pins will ensure that the 7KM expansion module is plugged in correctly.
5. Tighten the screws of the 7KM PAC expansion module to a torque of 0.5 Nm [4.5 lb-in].

5.2.2 Operator controls and displays

The COM800 / COM100 breaker data server is equipped with the following operator controls and displays:

- LED display
- Write-protect switch

This chapter provides a guide to use of the operator controls.





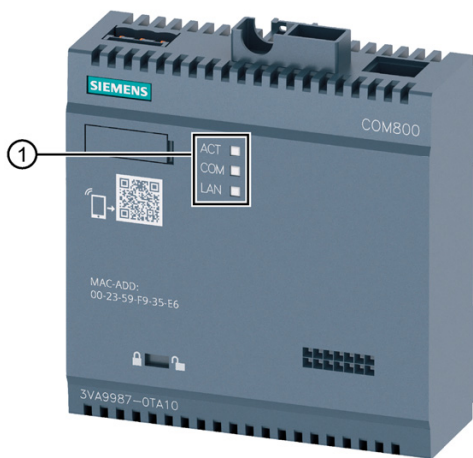







5.2.2.1 LED display

The COM800 / COM100 breaker data server has three LEDs for signaling status information.



- ① LED display

The following table provides an overview of possible LED states:

LED	Meaning	Description
 ACT	Off	No power supply
 ACT	Flashing (2 Hz)	Device powering up. Restricted operation ³⁾
 ACT	On	Ready for Operation
 COM	Off	No communication
 COM	Green Flashing (2 Hz)	Connection establishing to 3VA-line ¹⁾
 COM	Red Flashing (2 Hz)	Connection establishing to 3VA-line ²⁾
 COM	On	Communication with 3VA OK
 COM + ACT	Flashing (2 Hz)	Identification as communication partner
 LAN	Off	No communication via integrated Ethernet interface
 LAN	Flashing (2 Hz)	Connector ok, but no communication
 LAN	On	Communication via integrated Ethernet interface
 COM + ACT + LAN	Flashing (2 Hz)	Exceptional situation which cannot be remedied by user ⁴⁾
 COM + ACT + LAN	Off	COM800 / COM100 not functioning ⁵⁾

- 1) If the state persists for longer than 10 s, it is an indication of a communication error on the 3VA-line.
Measures
- Check whether all plug-in connections are correctly inserted.
 - Check whether both terminating resistors are correctly inserted.
 - Check whether more than the maximum permissible number of 3VA molded case circuit breakers (COM800: 8; COM100: 1) are connected to the COM800 / COM100 breaker data server.
- 2) The actual 3VA-line does not match the configured 3VA-line, for example, more or fewer 3VA molded case circuit breakers than the configured number are connected.
Measures:
- Check whether all configured 3VA molded case circuit breakers are connected
 - Check whether other 3VA molded case circuit breakers that have not been configured are connected
- You can view the target configuration (and update it, if necessary) in powerconfig.
- 3) ACT also flashes green when a firmware update is in progress. If ACT flashes continuously, it is recommended to update the firmware of the COM800 / COM100. powerconfig can be used to investigate the cause of the fault and restore the device to its normal operating condition.
- 4) Please contact technical support (<https://support.industry.siemens.com/cs/de/en/>).
- 5) No power supply or more than (8) 3VA molded case circuit breakers connected.

5.2.2.2 Write-protect switch

The COM800 / COM100 breaker data server is equipped with a write-protect slide switch.

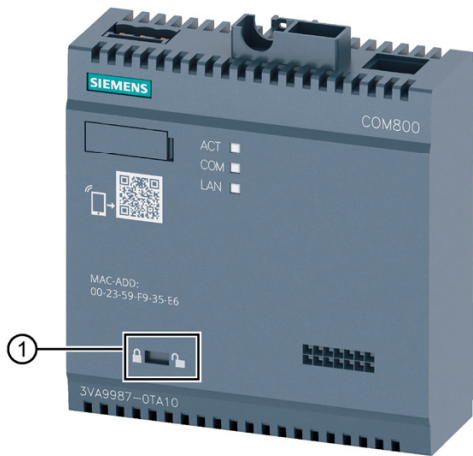

① Write-protect switch

When write protection is activated, configuration settings cannot be made via the communication system, e.g. by powerconfig. It is still possible to change warning and alarm limits.

The user is notified in powerconfig about any actions which have been rejected as a result of the write protection.

Write protection activated	Write protection deactivated	Function
	■	Parameter assignment via communication channel
	■	Firmware update
■	■	Read out configuration
■	■	Read measured values and load profiles
■	■	Change limits
	■	Change digital outputs
■	■	Time synchronization
	■	Switch via SEO

In order to prevent unauthorized manipulation of settings, it must be ensured that the COM800 / COM100 breaker data server is not accessible when the write protection is activated.

5.2.3 Commissioning

5.2.3.1 First commissioning

The COM800 / COM100 breaker data server can only be commissioned by means of powerconfig. The breaker data server can be accessed from powerconfig using the function "Search for Accessible Devices (F11)" on the condition that a communication link has been established via Ethernet or the plugged-in communication module.

Search for Accessible Devices

1. Select the network used in the dialog "Search for Accessible Devices". Commissioning and service software: powerconfig (Page 211).

Example: "Ethernet" network: With multiple Ethernet interfaces, the Ethernet interface used must be selected via "Ethernet interface".

2. Start the search 

All SENTRON devices (including COM800 / COM100) on the selected network are displayed

Select the correct COM800 / COM100 breaker data server

The COM800 / COM100 breaker data server to be used can be identified by:

- the MAC address printed on the device
- an optical identification command by means of flashing of the ACT and COM LEDs

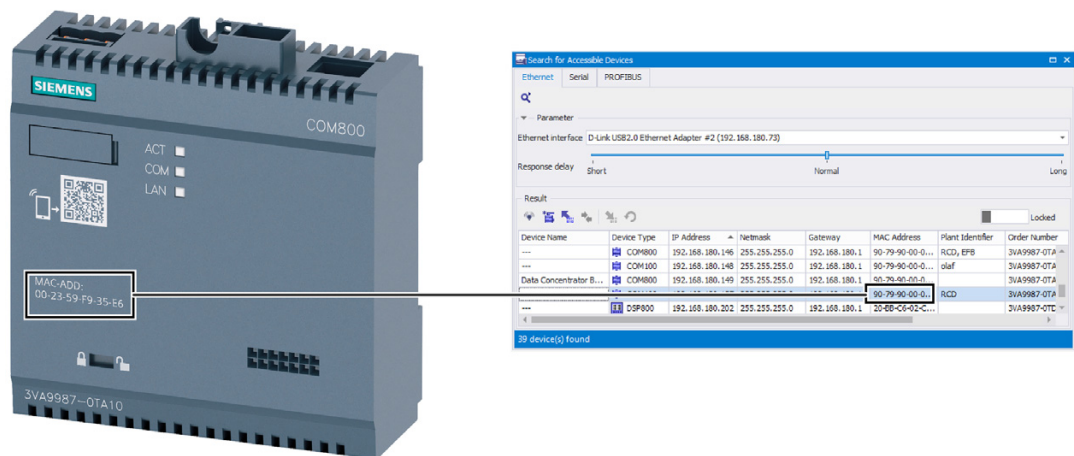

After the COM800 / COM100 had been identified, the button "Change network settings" must be selected to alter network settings in accordance with the planned network.

The COM800 / COM100 breaker data server can then be added to the project with the "Add" button.

Editing the device settings

1. Change to edit mode by "unlocking" the dialog.
2. Complete the missing specifications (e.g. device name, IP address ...)
3. Create the COM800 / COM100 breaker data server in powerconfig .
4. Load the settings into the COM800 / COM100 breaker data server.

See also

Communication network planning (Page 106)

5.2.3.2 Configuring from the device library

If a COM800 / COM100 breaker data server is inserted in the project from the device library, the network settings must be made via the Communication view.

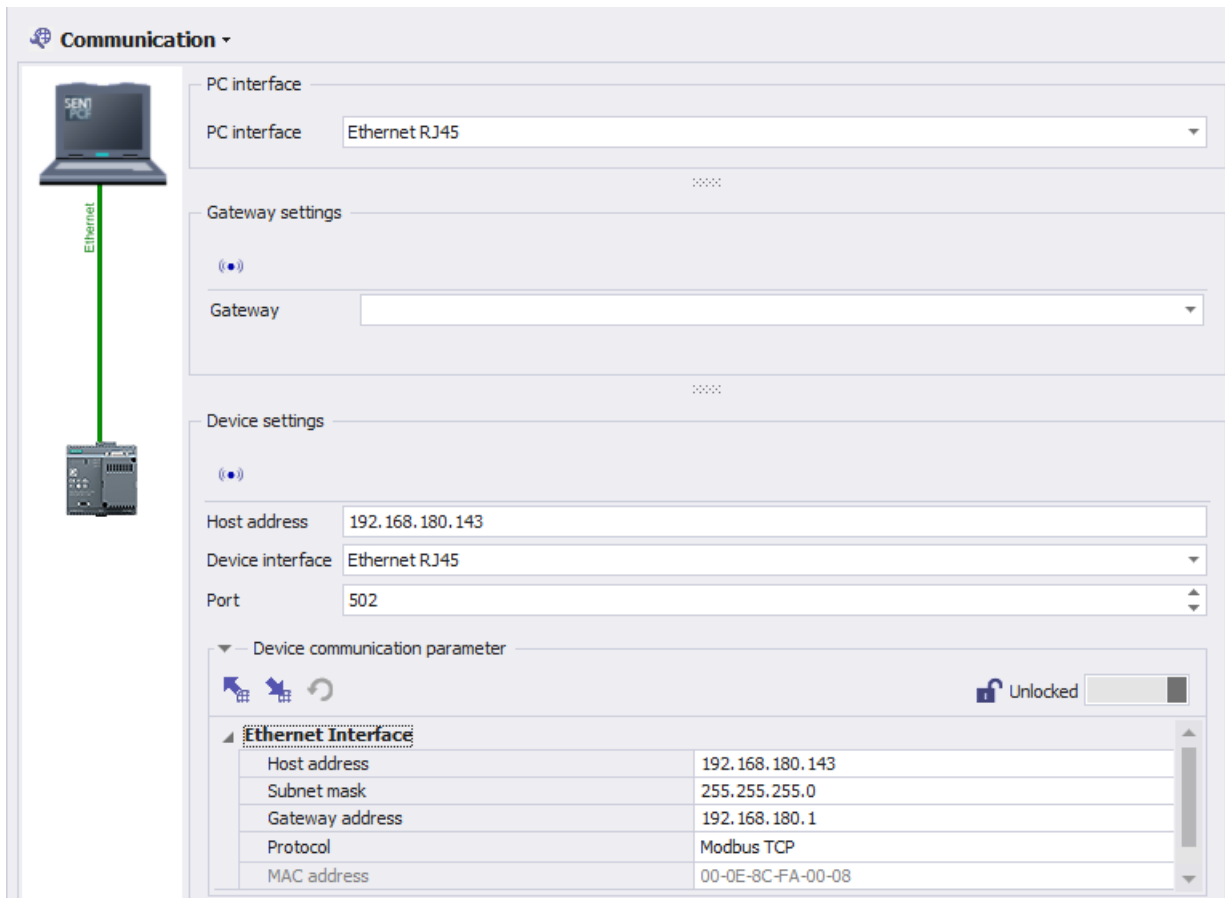

These settings are:

- IP address of the COM800 / COM100 breaker data server
- The subnet mask which marks the relevant positions of the IP address for the device with "0".

- It is also possible to enter the gateway address of a computer that can set up a connection from the network defined in the field "Subnet Mask" to another network (e.g. a router).

Other settings on the COM800 / COM100 breaker data server

The following settings can be made with powerconfig on the COM800 / COM100 breaker data server:

- Date & time:
 - Menu Device > Date and Time Settings
- Parameterize an SNTP server that will supply time information:

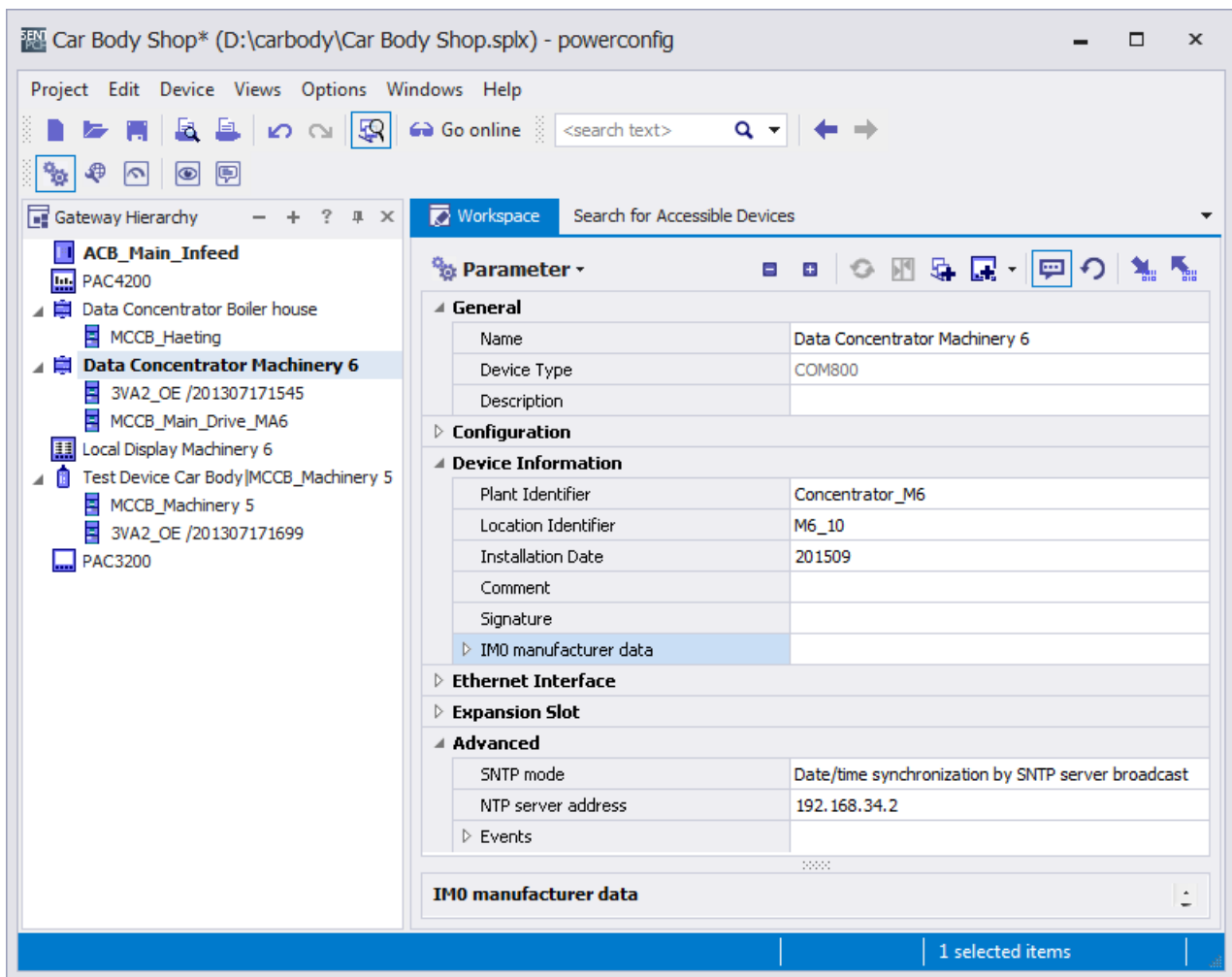

Note

Without an SNTP server, the time of day must be reset following an interruption of the supply voltage.

Additional options for time synchronization

- Commissioning and service software: powerconfig (Page 211)
- Power monitoring with powermanager (Page 95)
- PROFIBUS DP (Page 163)
- PROFINET IO (Page 184)

See also

First commissioning (Page 115)

5.2.3.3 Resetting

A communication link must have been established via Ethernet before the COM800 / COM100 breaker data server can be reset. The COM800 / COM100 breaker data server must also be selected in the project. Parameters can then be reset via the reset commands in the "Device" menu or the shortcut menu. If the communication parameters are reset, it is impossible to communicate with the device until the communication parameters are entered again.

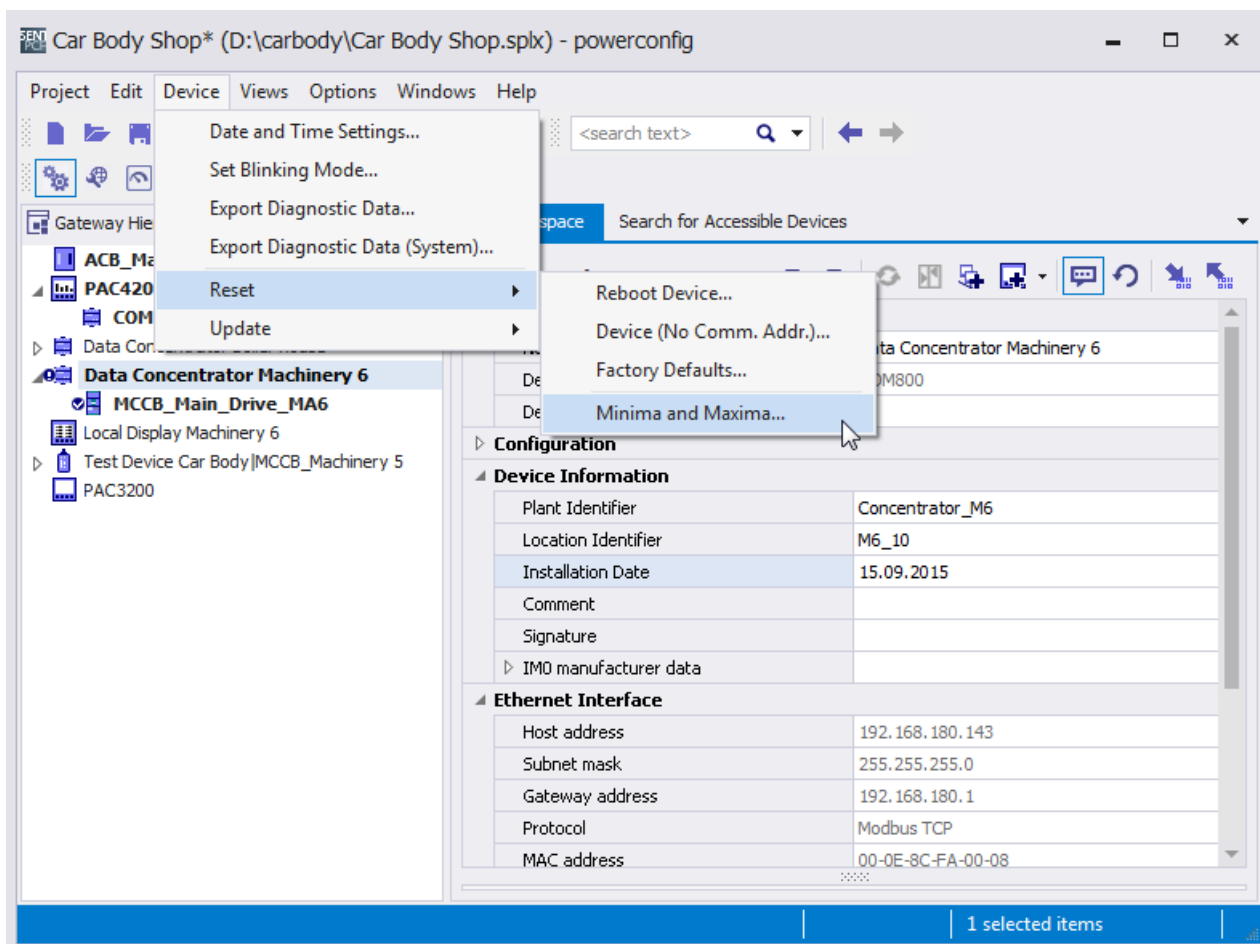

The COM800 / COM100 breaker data server can then be treated as if it were being commissioned for the first time (Page 115).

5.2.3.4 Commissioning a 3VA connected to COM800 / COM100

Select the COM800 / COM100 breaker data server from the project

Precondition: An IP address has already been assigned to the COM800 / COM100 breaker data server (e.g. from the First commissioning (Page 115)).

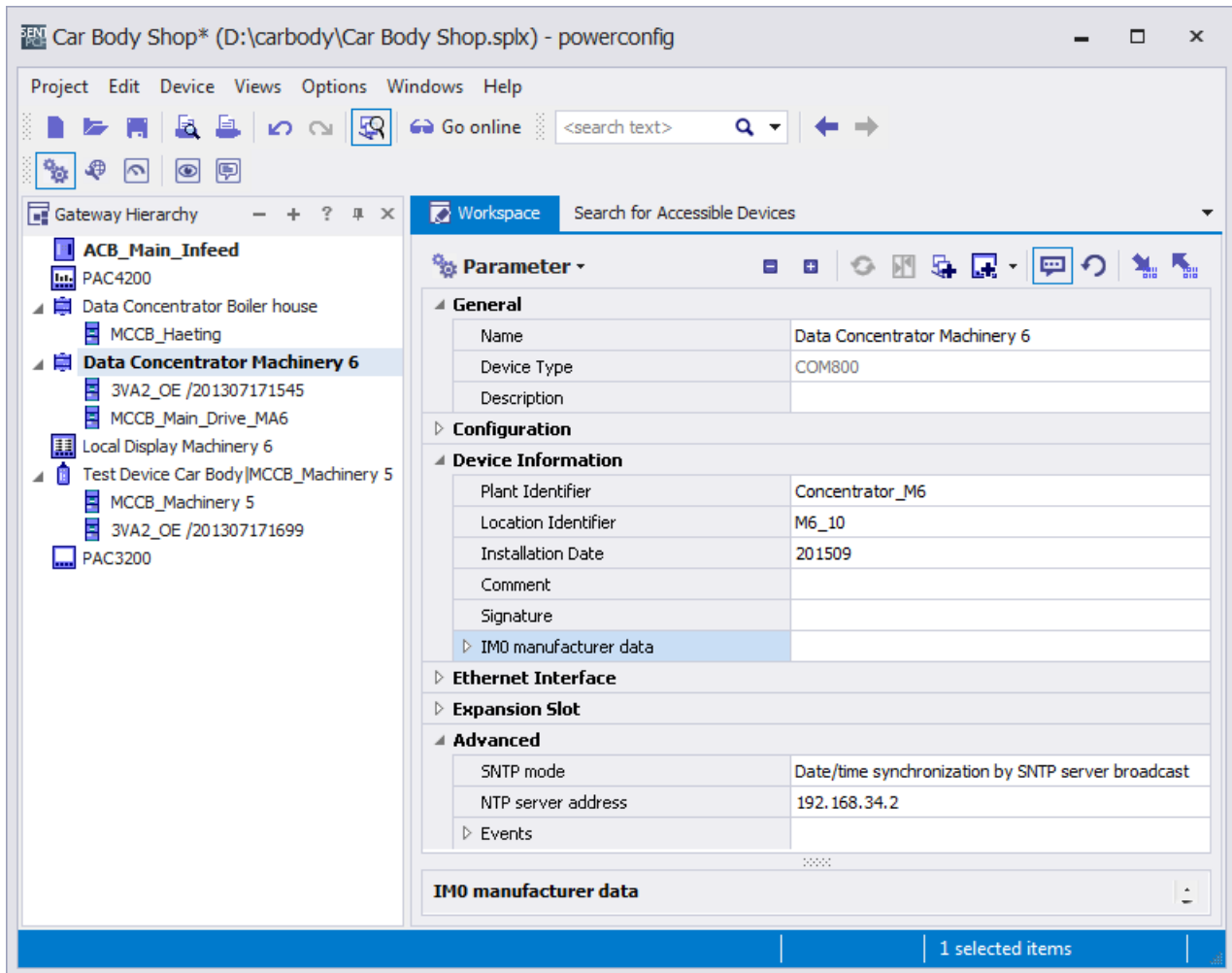

If the COM800 / COM100 breaker data server has not been added using the command "Search for Accessible Devices", it must be dragged out of the library and dropped in the project. The "Parameters" view opens when this is done. You can find additional information in chapter Parameterizing 3VA molded case circuit breakers (Page 222)

Automatic selection of 3VA molded case circuit breakers

Click on the icon  in order to establish a communication link with the selected COM800 / COM100 breaker data server.

In the "Overview", the COM800 / COM100 breaker data server automatically displays the 3VA molded case circuit breakers connected to it via the 3VA-line.

Use powerconfig to make 3VA molded case circuit breakers capable of communication

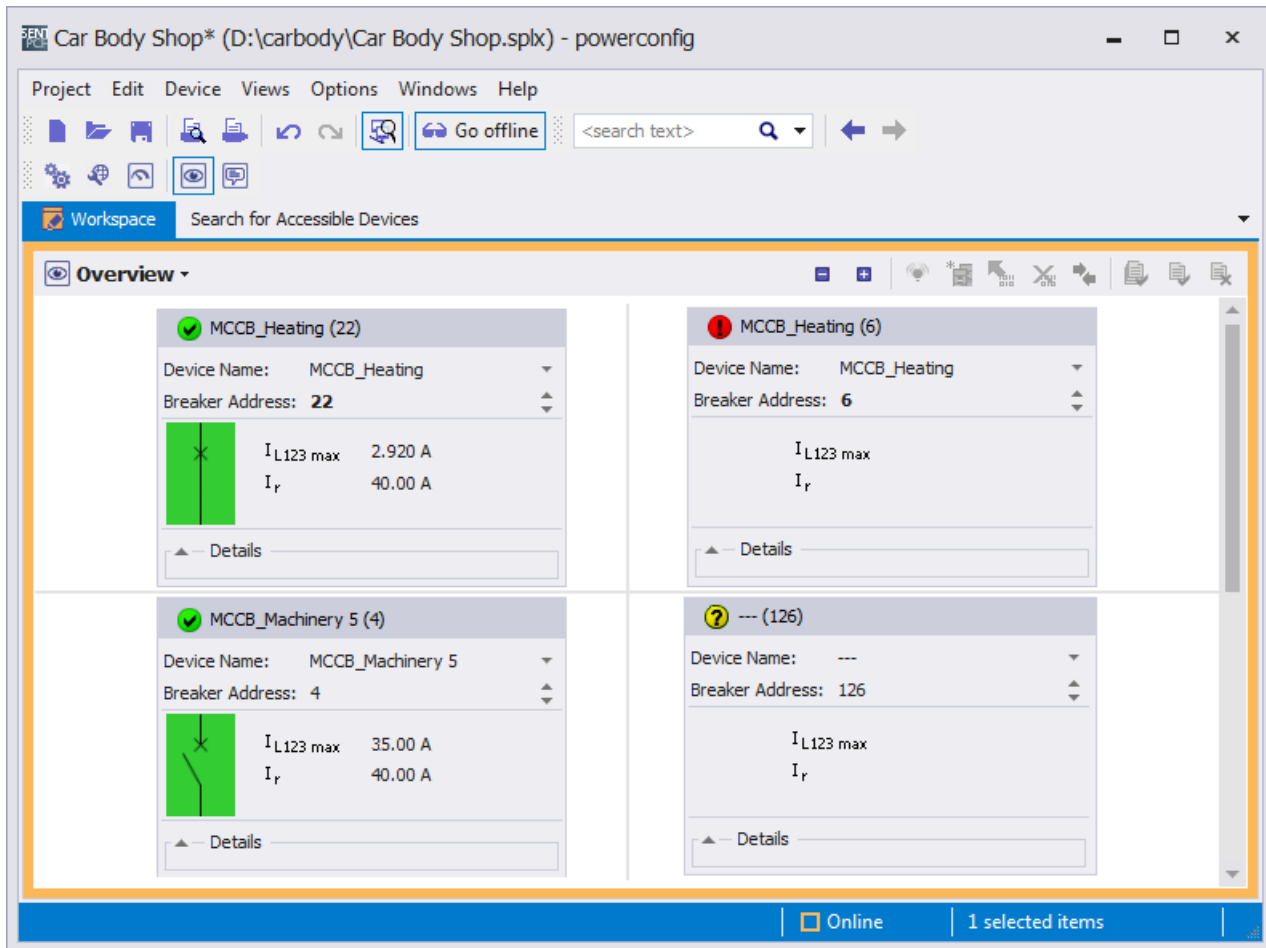

The following paragraph describes the correct procedure for connecting a new 3VA molded case circuit breaker:

Assign a breaker address

Every 3VA molded case circuit breaker connected to the COM800 / COM100 breaker data server is automatically detected and displayed with  on the screen.

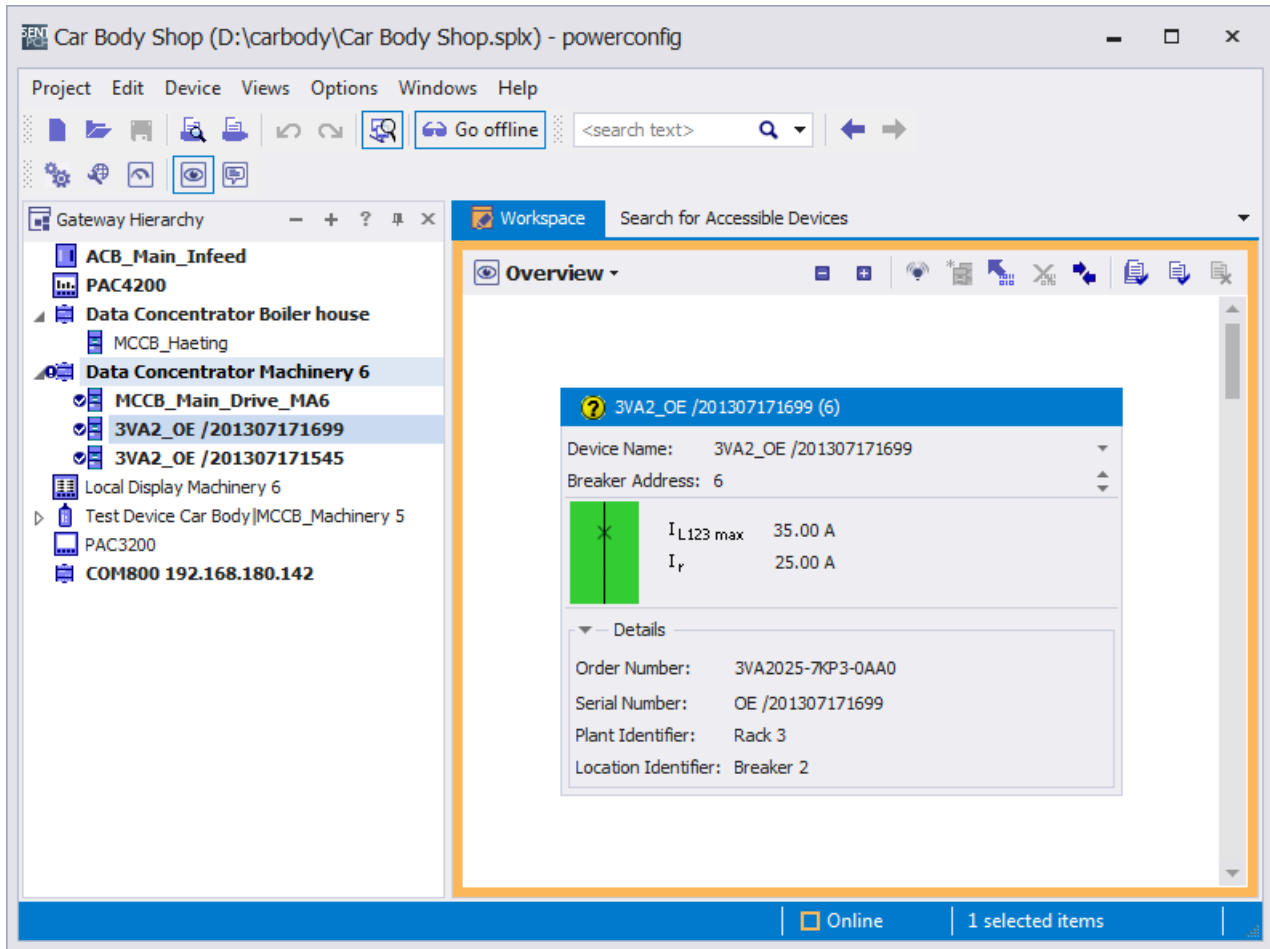



A breaker address is assigned to each 3VA molded case circuit breaker so that it can be identified by higher-level systems and used for other purposes.

The 3VA breakers are permanently transferred to the COM800 / COM100 configuration with . The COM800 / COM100 breaker data server can then monitor the accessibility of the 3VA molded case circuit breaker and signal any deviations from the correct status.

A click on the icon  transfers the 3VA to the powerconfig project.

A click on the icon  can initiate flashing of the ACT+COM LED on the ETU in order to identify the 3VA. This confirms that the 3VA is clearly identified in the communication system via the IP address of the COM800 / COM100 and the breaker address.

The protection parameters set for the 3VA as well as the configuration can either be transferred to powerconfig with the icon  or the protection parameters and the desired configuration can be set in powerconfig and then loaded to the 3VA at an appropriate time by means of the  icon.

It is advisable to assign an identity to the 3VA molded case circuit breaker in the form of

- a device name in powerconfig
- a plant and location identifier in the breaker.

5.2.4 Operation

The COM800 / COM100 breaker data server makes the database (see chapter Available database (Page 73)) of 3VA molded case circuit breakers available to the communication interfaces.

The relevant functions are:

- Commission and maintain the power distribution system. See chapter Commissioning and service software: powerconfig (Page 211).
- Display, archive and monitor states and measured variables of the connected 3VA molded case circuit breakers in applications. See chapter Application examples (Page 91).
- Evaluate maintenance and operating data.

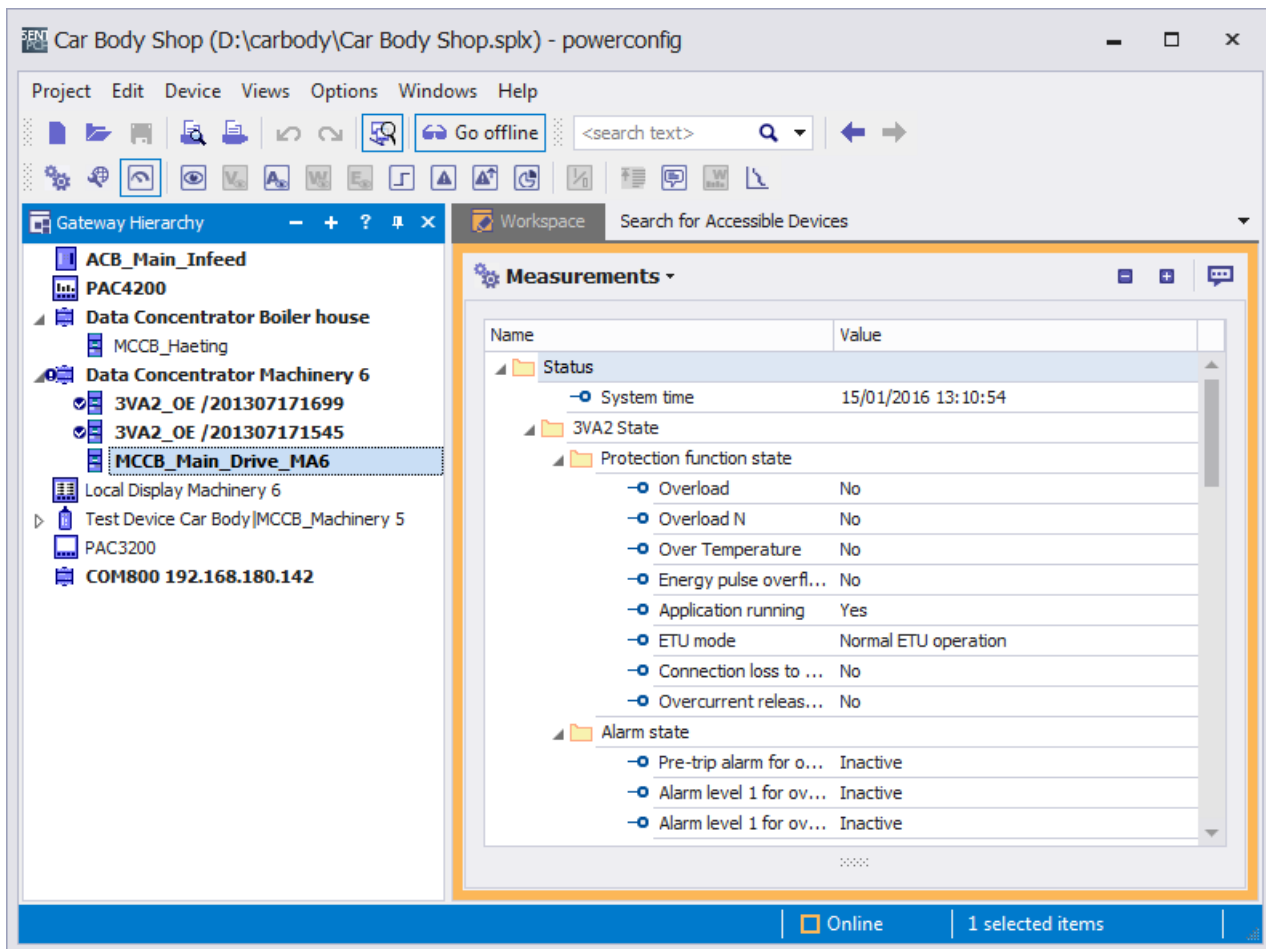

- In order to obtain the operating data of the COM800 / COM100 breaker data server and the connected 3VA breakers, the component must be selected in the project and a communication link established using the icon .

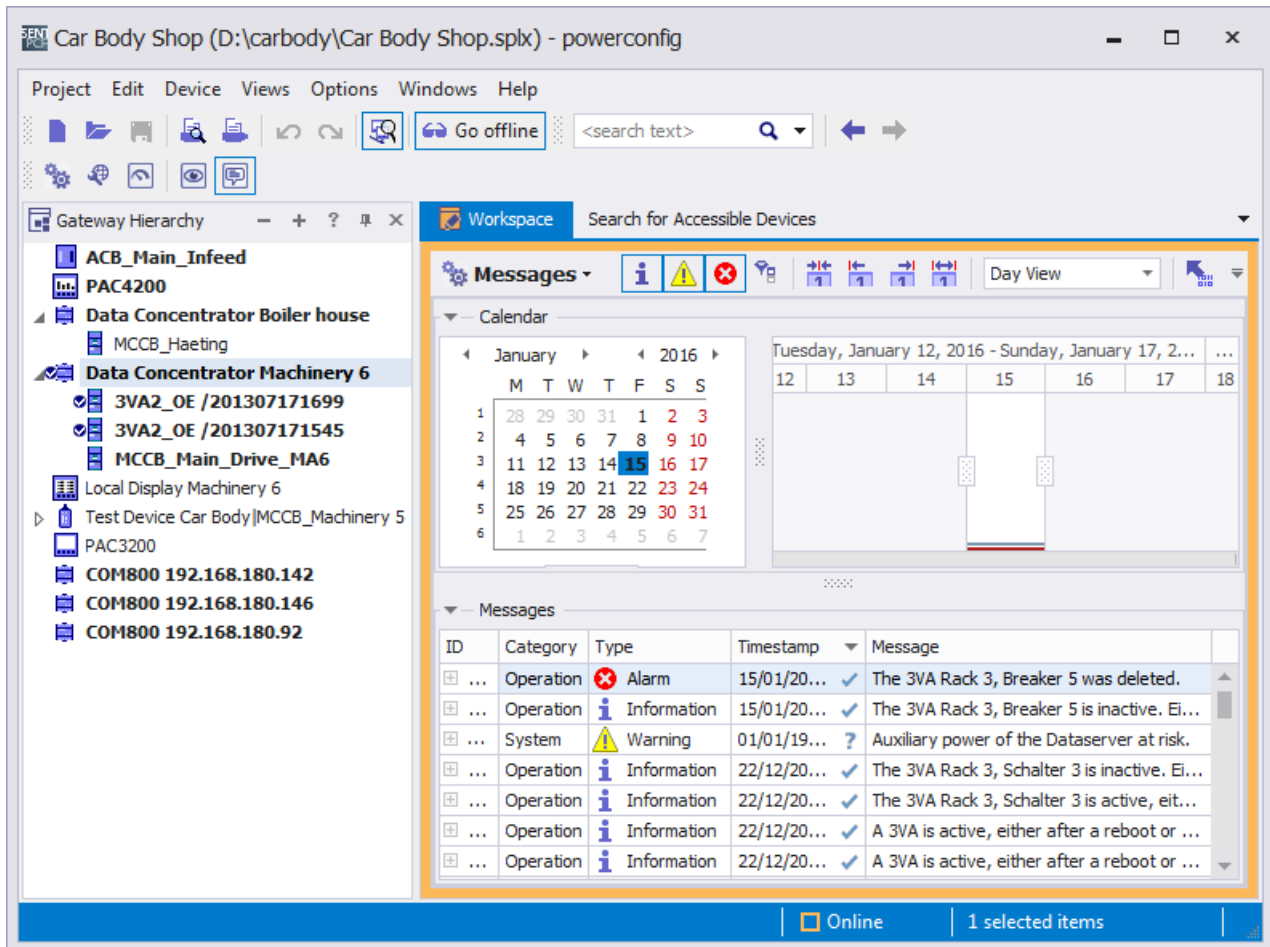

The COM800 / COM100 breaker data server collects the events pertaining to the connected 3VA molded case circuit breakers and lists them in an event log:

Events which can be logged

Operational events (see chapter Messages (Page 72)Messages) or operator action and system messages (see chapter Understanding status transitions (Page 251)) can be logged.

All these events can be read out of the COM800 / COM100 with powerconfig during operation, analyzed by the user and saved as a file in format ".csv" by means of icon .

The event log can also be cleared with menu commands Device > Reset > Event Log.

See also

Acquiring and communicating measured variables (Page 52)

5.3 COM060 communication module and draw-out unit

This chapter gives instructions on how to connect up and use the COM060 communication module. For information about installation, please refer to the operating instructions.

5.3.1 Connecting

5.3.1.1 Connection of supply voltage

The COM060 communication module is supplied with power by the COM800 / COM100 breaker data server via the 3VA-line.

5.3.1.2 Connecting the 3VA-line

The COM060 communication module is connected by its connecting cable to a T-connector of the 3VA-line. You can find more information in chapter Connecting the 3VA-line (Page 109) to the COM800 / COM100 breaker data server.

5.3.1.3 Connecting the T-connectors

The T-connector is installed on the 3VA molded case circuit breaker within reach of the connecting cable of the COM060 communication module.

As well as the three pre-assembled connecting cables of the Connecting the 3VA-line (Page 124), the functional ground must also be connected as directly as possible with the equipotential bonding.

5.3.2 Commissioning

5.3.2.1 First commissioning

The COM060 communication module is commissioned in conjunction with the COM800 / COM100 breaker data server. You can find more information in chapter Commissioning (Page 115).

5.3.2.2 Resetting

If a COM060 communication module (typically including a 3VA molded case circuit breaker) is operated on a different COM800 / COM100 breaker data server, it must be ensured that the breaker address does not conflict with a pre-existing breaker address.

A COM060 communication module can be operated on a different breaker data server. Instructions on how to exchange a 3VA molded case circuit breaker can be found in chapter Replacing the 3VA molded case circuit breaker connected to a COM800 / COM100 (Page 247)

5.3.2.3 Commissioning with powerconfig

The COM060 communication module does not require separate settings.

5.3.3 Operation

The COM060 communication module transfers all data of the 3VA molded case circuit breaker.

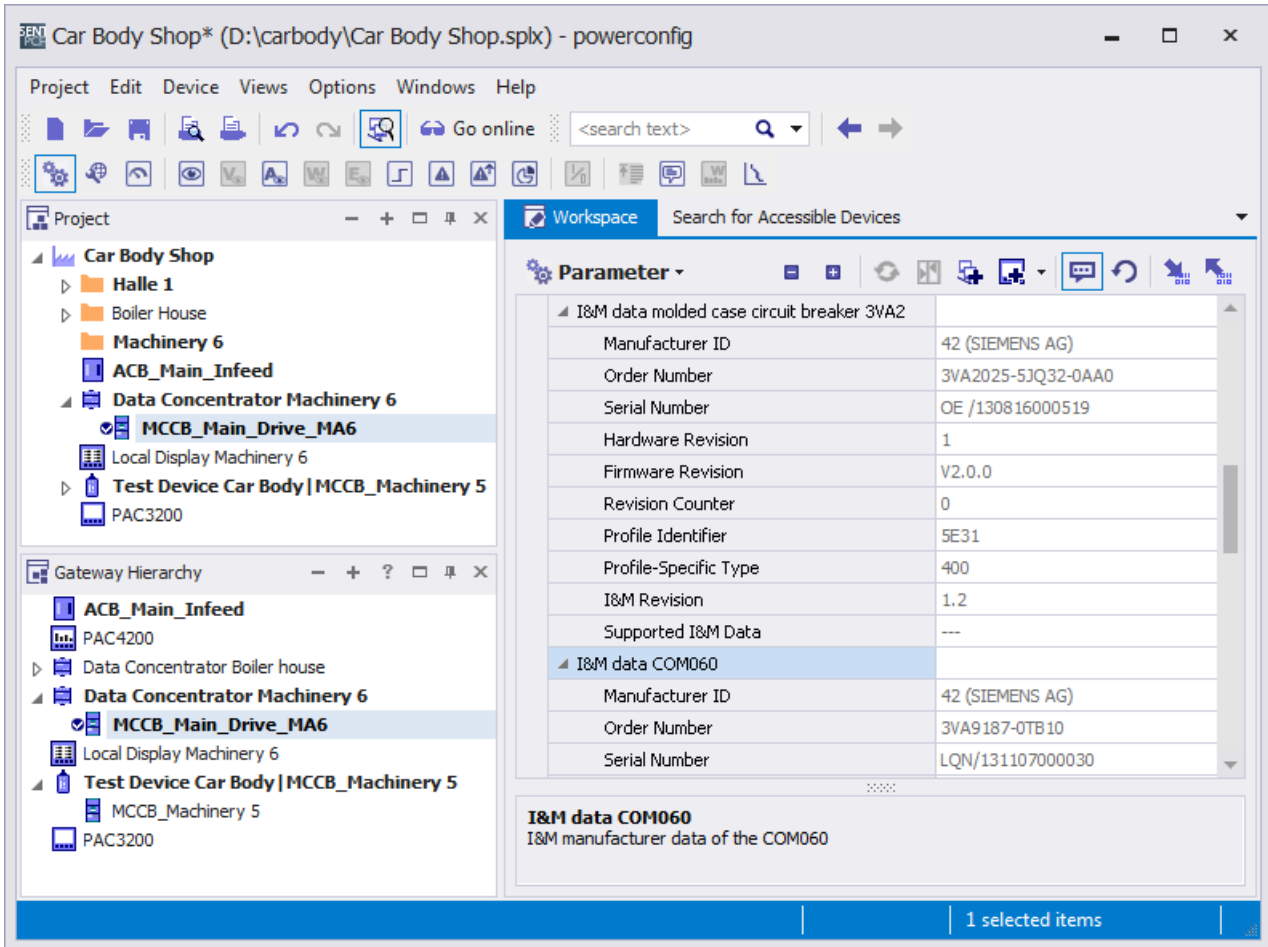

5.3.3.1 Position in draw-out unit

The position of the 3VA molded case circuit breaker in the draw-out unit can generally be interrogated as a Modbus register by any application. This is often done using powerconfig during commissioning and maintenance.

See also View → Measured Variables → Operation (Page 130)

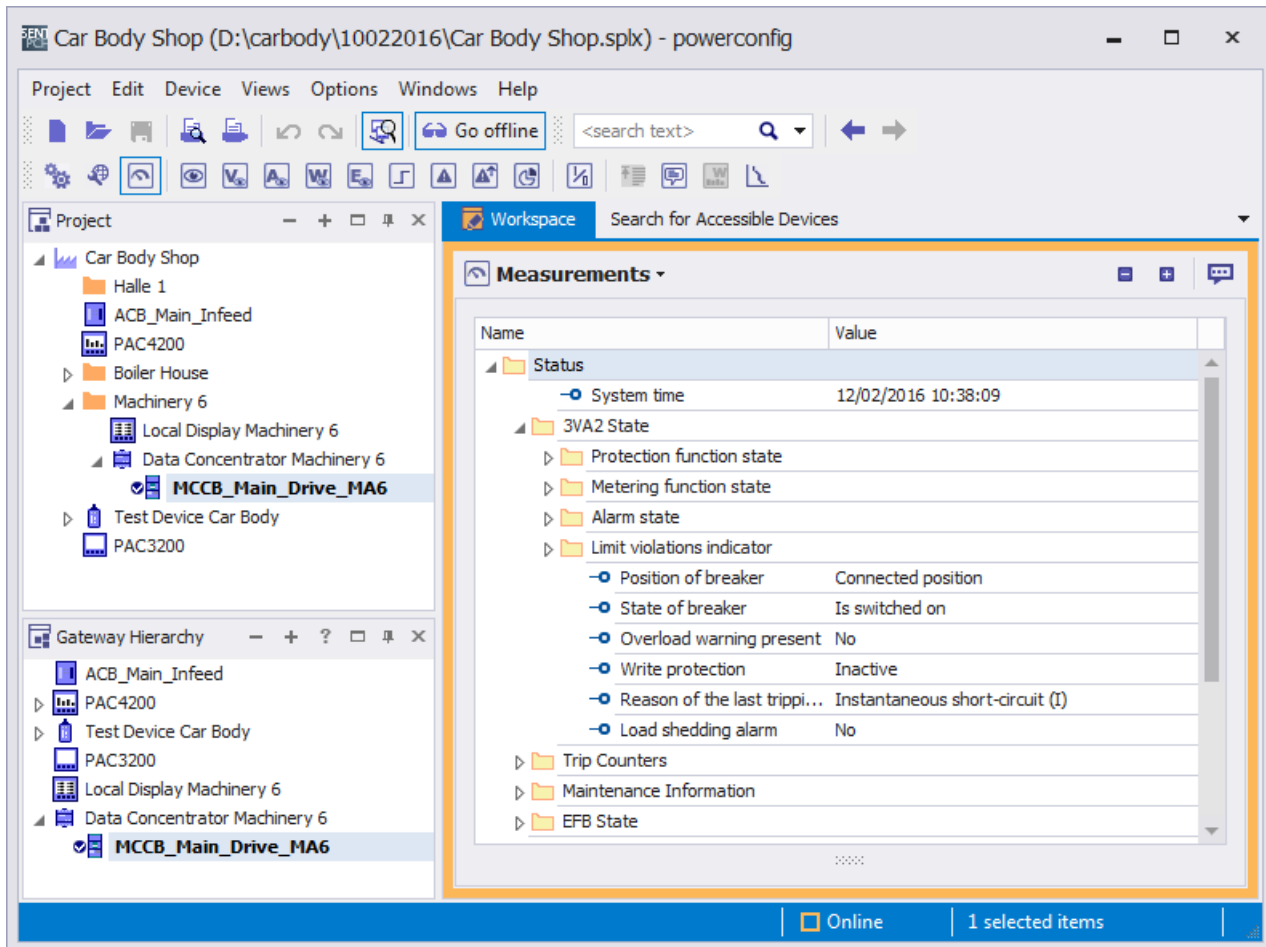

5.4 Communication with ETUs 5-series and 8-series

The electronic trip units of the 3VA molded case circuit breaker can be accessed via two communication channels:

1. Via the TD500 test device: You can find information on this in chapter TD500 test device (Page 148); for temporary actions, e.g. with powerconfig: See chapter Commissioning and service software: powerconfig (Page 211)
2. Via COM800 / COM100: You will find more information on this in chapter COM800 / COM100 breaker data server (Page 107) via COM060, and in chapter COM060 communication module and draw-out unit (Page 124); for continuous communication.

5.4.1 Connecting

5.4.1.1 Connection of supply voltage

For their protection functions, the ETUs 5-series and 8-series are supplied with power from the main circuit. ETUs 5-series and 8-series require a 24 V supply for their metering, display and communication functions. This supply can be provided by:

- the COM800 / COM100 breaker data server (typically for communication-capable 3VA molded case circuit breakers)
- the EFB300 external function box
- the 24 V module if only a metering function with display on the ETU is needed but no communication is required

It is permissible to supply the ETU from the TD500 test device only when the molded case circuit breaker is switched off.

5.4.1.2 Connecting the ETUs 5-series and 8-series for communication

The ETUs 5-series and 8-series are connected to a PC by means of the following components:

- COM060 communication module (see chapter COM060 communication module and draw-out unit (Page 124)) connected to COM800 / COM100 breaker data server (see chapter COM800 / COM100 breaker data server (Page 107))
- Communication network or TD500 test device, see chapter TD500 test device (Page 148).

5.4.2 Operator controls and displays

You can find information about the operator controls and displays in chapter What to do in the event of communication faults (Page 253) under Signaling the communication capability.

5.4.3 Commissioning

5.4.3.1 First commissioning

The ETUs are set to maximum protection (i.e. minimum setting parameters) when they are delivered. Parameters can be set via the ETUs.

5.4.3.2 Resetting

It is not possible to completely reset all settings on ETUs.

5.4.3.3 Commissioning with powerconfig

The ETUs 5-series and 8-series can be commissioned locally via the buttons on the LCD. You can find further information in chapter "Electronic trip unit" of the manual for 3VA molded case circuit breakers.

It may be more convenient to commission an ETU with powerconfig because the properties and the parameters of the 3VA molded case circuit breaker can be read out, and the parameters adapted to the application case and then downloaded to the 3VA molded case circuit breaker again.

- Configuration with order number, size, rated current, number of poles and equipment
- Protection parameters of the 3VA molded case circuit breaker

The following settings can be made:

- Options used, e.g. EFB300, RCD (IEC only) and their parameters
- Communication interfaces
- Identification of the 3VA molded case circuit breaker in the system
- Protection parameters
- Behavior of the 3VA molded case circuit breaker within the system, e.g. load monitoring and ZSI
- Metering function (energy flow)
- Limit values (current and voltage unbalance)
- Behavior of the 3VA molded case circuit breaker with respect to the user, e.g. event logging function

A description of suitable ETUs for specific applications, their protection settings and operating principles can be found in chapter "Protection system" of the manual for 3VA molded case circuit breakers. 3VA molded case circuit breakers can be commissioned correctly only if these aspects are understood.

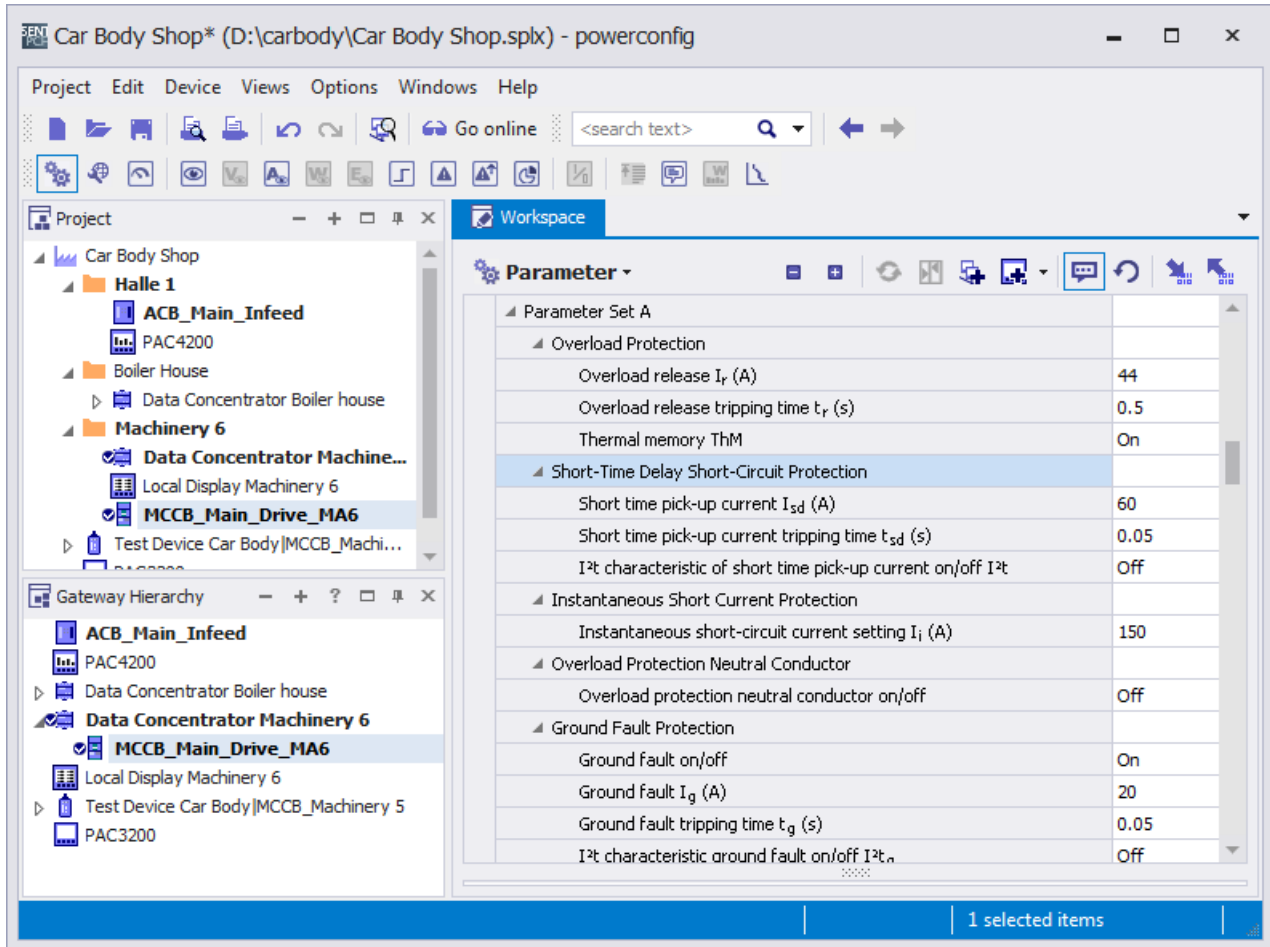

See also

Commissioning and service software: powerconfig (Page 211)

5.4.3.4 Signaling the communication capability

The ETUs 5-series and 8-series are equipped with a "COM" LED which lights up green when the ETU is connected to the COM800 / COM100 breaker data server via the COM060 communication module.

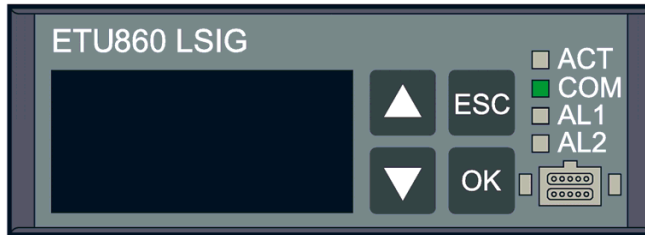

5.4.4 Operation

The screenshot below provides an overview of the information delivered by the ETU860:

The screenshot displays the 'powerconfig' software interface. The main window shows an 'Overview' section for a circuit breaker. On the left, a vertical bar indicates the current status of Phase L2, with a green section at the bottom labeled '35A' and a red line at the top labeled 'Overload release I_r 44 A'. To the right, a text box states: 'The circuit breaker is closed. At the moment there are neither tripping nor warning or setpoint messages present.' Next to this text is a green square with a black 'X' over it. Below the text box is a table with the following data:

Plant Identifier	Rack 3
Location Identifier	Breaker 5
Current L1	35.0 A
Current L2	30.0 A
Current L3	30.0 A
Current N	10.0 A
Current G	0.0 A
System time	15/01/2016 10:0...

At the bottom of the overview section, there are two message fields: 'Last Warning Message' (No messages available) and 'Last Trip Message' (The 3VA tripped because of an instantaneous short-circuit...). The bottom status bar shows 'Online' and '1 selected items'.

A detailed overview of measured variables can be found in chapter Acquiring and communicating measured variables (Page 52).

Status information is specified in sufficient detail in powerconfig.

See also

Available database (Page 73)

5.5 EFB300 external function box

This chapter gives instructions on how to connect up and use the EFB300 external function box. You can find information about installation in the Operating Instructions (<http://support.automation.siemens.com/WW/view/en/80600828/0/en>) on the Internet.

5.5.1 Connecting

5.5.1.1 Connecting the 24 V supply

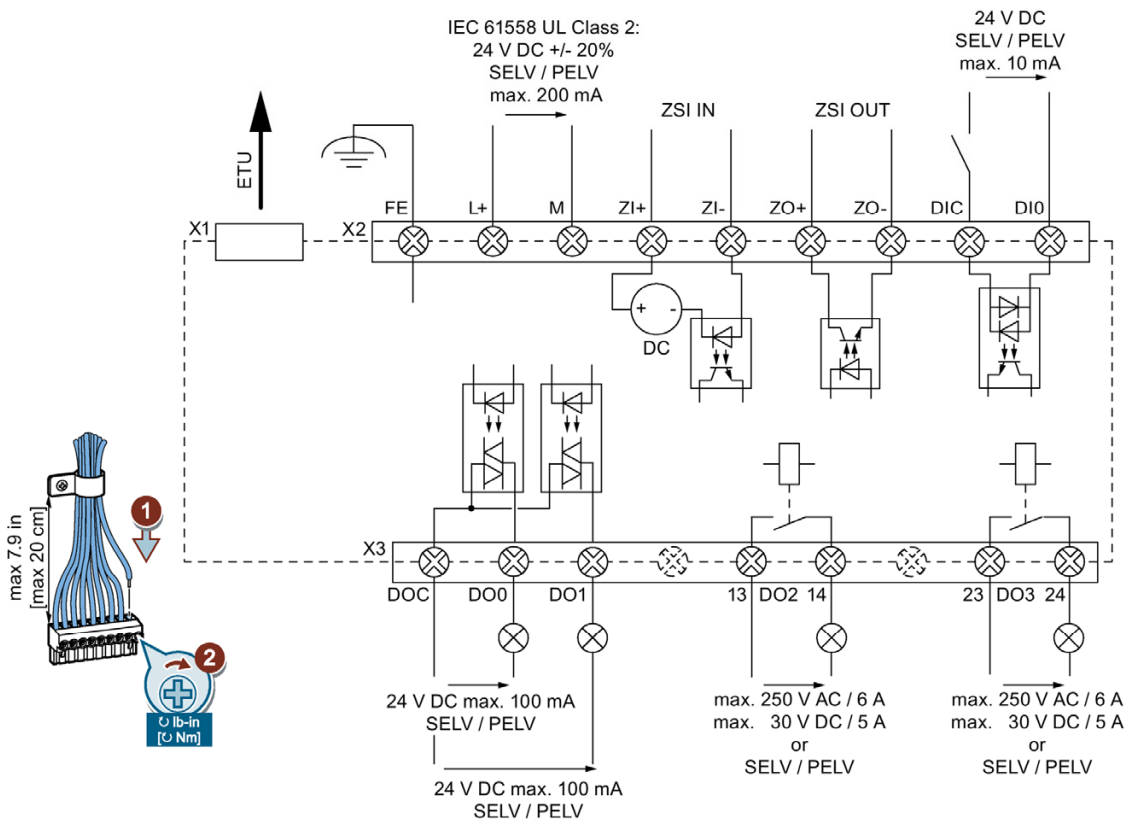

5.5.1.2 Connection of the EFB300 external function box

The EFB300 is connected to the ETU by means of the plug-in cable (1.5 m) supplied with the device.

The following lengths of cable for connecting the EFB300 to the 3VA are optionally available.

- 3.0 m (without RCD)
- 3.0 m for 3VA with EFB and RCD820 (IEC only)

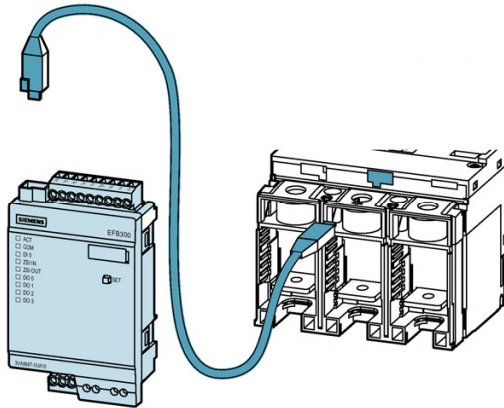





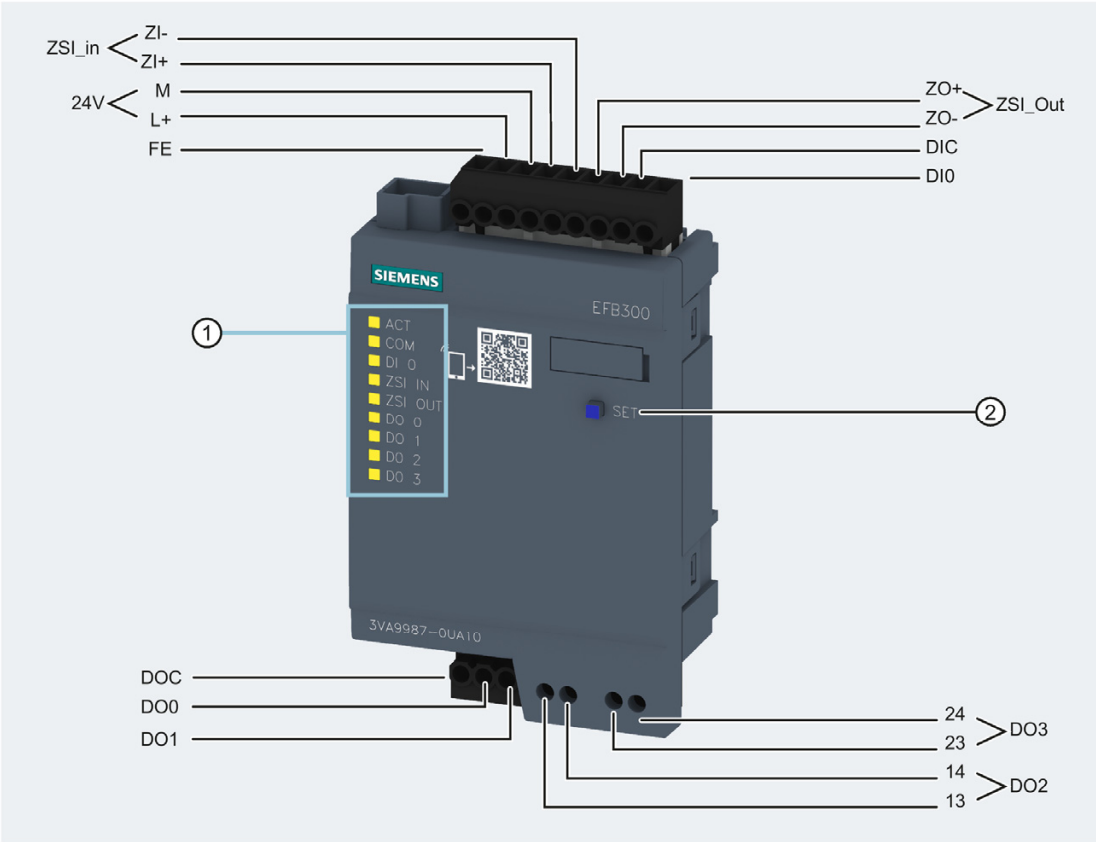





5.5.2 Operator controls

5.5.2.1 Display elements and terminal assignments



① LED displays

② <SET> button

LED	Meaning	Description
<input type="checkbox"/> ACT	Off	EFB300 not active
 ACT	On	EFB300 ready
<input type="checkbox"/> COM	Off	No communication link with ETU
 COM	Flashing (2 Hz)	Establishing communication link with ETU
 COM	On	Communication link with ETU established
<input type="checkbox"/> DI 0	Off	Input not activated
 DI 0	On	Input activated
<input type="checkbox"/> ZSI IN	Off	No notification from lower-level breakers regarding ZSI
 ZSI IN	On	Information from at least one breaker regarding ZSI
<input type="checkbox"/> ZSI OUT	Off	No information to higher-level breaker
 ZSI OUT	On	Information to higher-level breaker regarding own ZSI detection
<input type="checkbox"/> DO 0	Off	Output not activated
 DO 0	On	Output activated
<input type="checkbox"/> DO 1	Off	Output not activated
 DO 1	On	Output activated
<input type="checkbox"/> DO 2	Off	Output not activated
 DO 2	On	Output activated
<input type="checkbox"/> DO 3	Off	Output not activated
 DO 3	On	Output activated

The user can start test mode using the <SET> button (LEDs flash). You can find more information on this in chapter "External function box" in the 3VA manual.

The states of the signals of the EFB300 external function box are also displayed by powerconfig:

Menu View > Measured Variables > Status Information > EFB Status

5.5.3 Commissioning

5.5.3.1 First commissioning

All the digital outputs of the EFB300 are deactivated in the delivery state, i.e. the EFB300 external function box must be commissioned using powerconfig.

As soon as the EFB300 external function box is connected to the ETU and to a power supply, it can be accessed via powerconfig and the ETU. Various different communication options must be selected depending on the ETU in use. You can find additional information in Chapter EFB300 external function box (Page 27)

5.5.3.2 Resetting

The parameter settings for the functions of the EFB300 external function box can be changed individually for alternative uses.

5.5.3.3 Commissioning with powerconfig

A detailed description of the EFB300 external function box can be found in chapter "EFB300 external function box" in the manual. You will find information about individual parameters and their functions or operating principles in this chapter.

The table below provides an overview of the signals and functions of the EFB300 external function box according to the type of ETU in use.

	Number of poles	ETU 3-series						ETU 5-series				ETU 8-series			
		ETU320 LI		ETU330 LIG		ETU350 LSI		ETU550 LSI		ETU560 LSIG		ETU850 LSI		ETU860 LSIG	
		3	4	3	4	3	4	3	4	3	4	3	4	3	4
Trip reason overload		■	■	■	■	■	■	■	■	■	■	■	■	■	■
Trip reason short-time delayed short-circuit						■	■	■	■	■	■	■	■	■	■
Trip reason instantaneous short circuit		■	■	■	■	■	■	■	■	■	■	■	■	■	■
Trip reason overload at neutral conductor			■		■			■		■			■		■
Trip reason ground fault				■	■					■	■			■	■
Trip reason RCD		■	■	■	■	■	■	■	■	■	■	■	■	■	■
Trip reason overtemperature		■	■	■	■	■	■	■	■	■	■	■	■	■	■
Alarm level 1 for overload		■	■	■	■	■	■	■	■	■	■	■	■	■	■
Alarm level 2 for overload		■	■	■	■	■	■	■	■	■	■	■	■	■	■
Pre-trip alarm for overload		■	■	■	■	■	■	■	■	■	■	■	■	■	■
Temperature alarm		■	■	■	■	■	■	■	■	■	■	■	■	■	■
Alarm to indicate internal ETU fault		■	■	■	■	■	■	■	■	■	■	■	■	■	■
Violation of load shedding lower threshold limit		■	■	■	■	■	■	■	■	■	■	■	■	■	■
Violation of load shedding upper threshold limit		■	■	■	■	■	■	■	■	■	■	■	■	■	■
Energy pulse													■	■	■
Energy source	Apparent energy (kVAh)												■	■	■
	Active energy (kWh) import												■	■	■
	Active energy (kWh) export												■	■	■
	Reactive energy (kvarh) import												■	■	■
	Reactive energy (kvarh) export												■	■	■
Weight per pulse in kWh, kVAh, kVArh, kvarh	1 ... 1000 (increment 1 in kWh, kVAh or kVArh)												■	■	■
Pulse width in ms	30 ... 500 ms (increment 10 ms)												■	■	■
Time-delayed Zone Selective Interlocking ZSI			■	■	■	■	■	■	■	■	■	■	■	■	■
Load monitoring		■	■	■	■	■	■	■	■	■	■	■	■	■	■

The EFB300 external function box can be configured with powerconfig as described below:

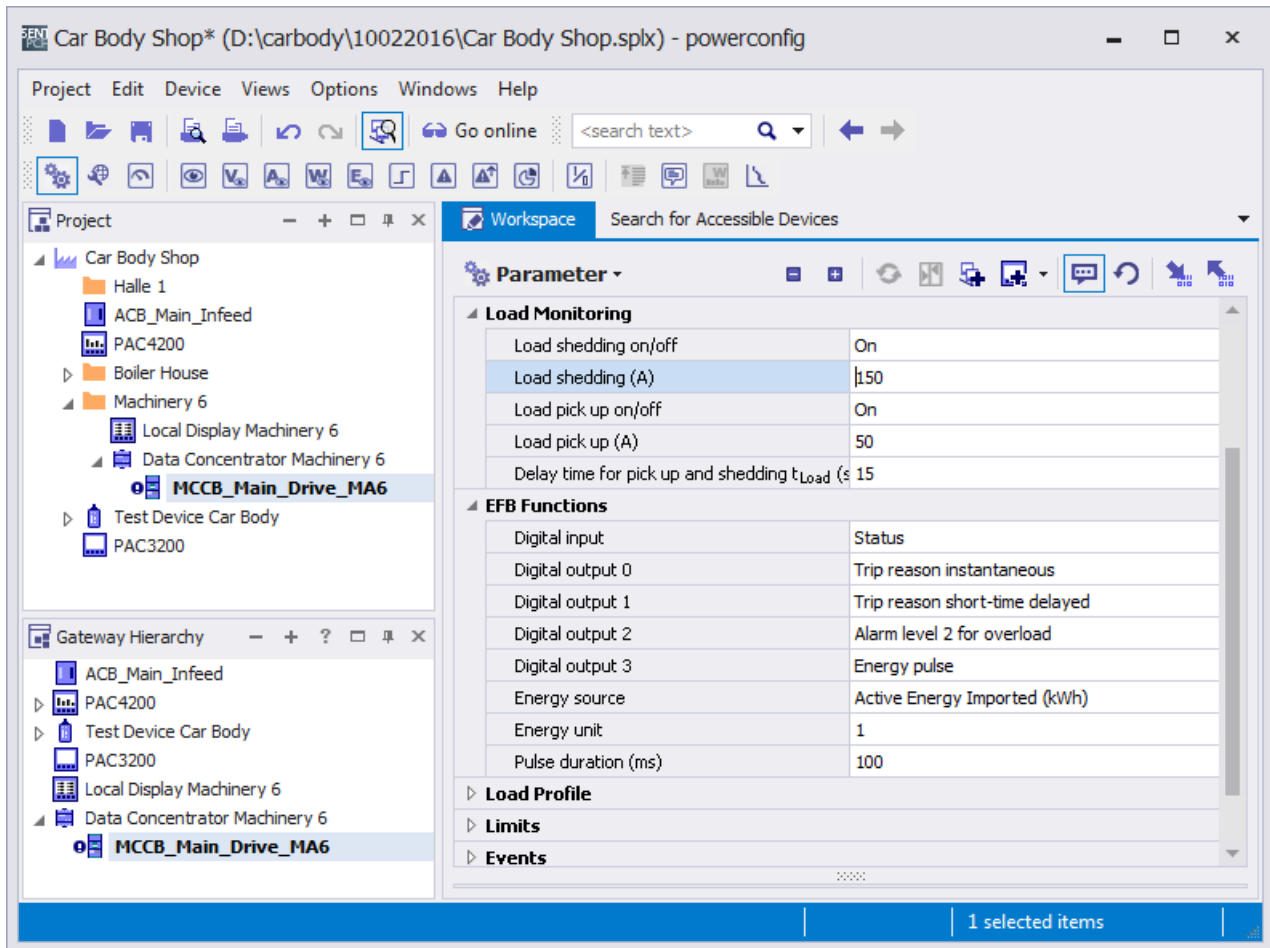

The EFB300 must be defined as an installed device in the 3VA molded case circuit breaker. The functions of the individual digital inputs and outputs can then be specified.

5.5.4 Operation

The EFB300 external function box uses digital signals to communicate with the environment of the 3VA molded case circuit breaker. powerconfig can be used to monitor the states of these signals.

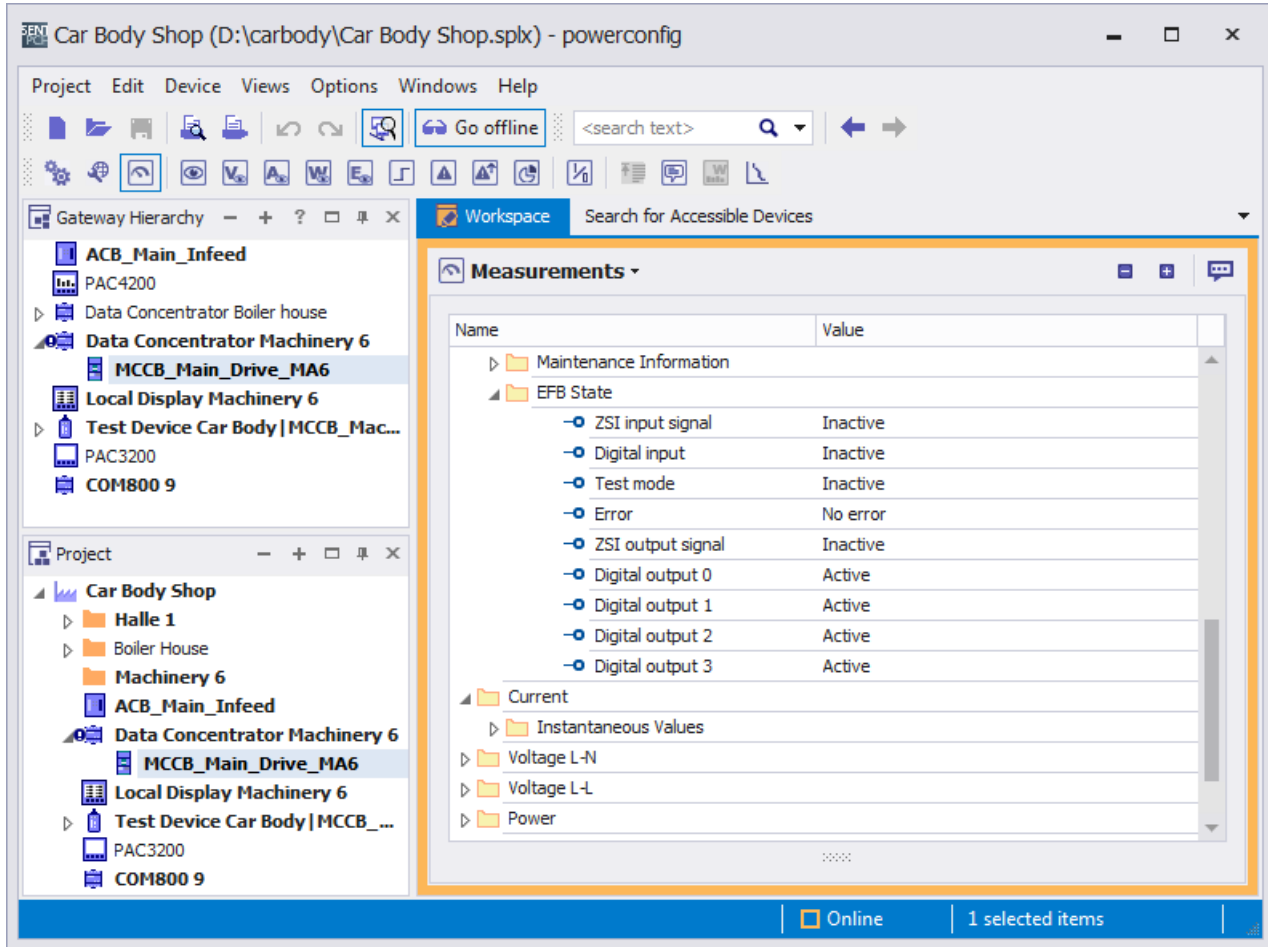

5.6 DSP800 display

The DSP800 display shows the data for up to 8 3VA molded case circuit breakers with ETUs 5-series and 8-series.

5.6.1 Connecting

5.6.1.1 Connecting the 24 V supply

The 24 V supply is connected via terminals.

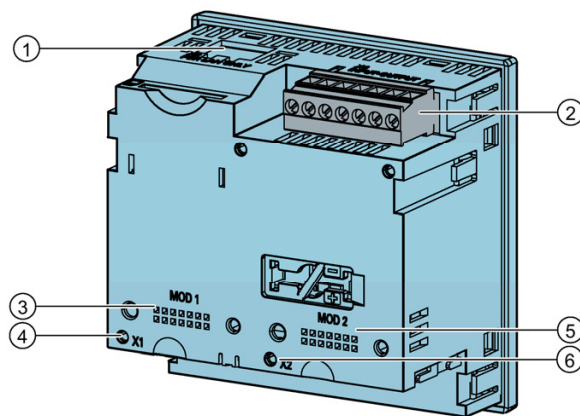

- | | |
|-----------------------------------|----------|
| ① RJ45 (LAN) | ④ Unused |
| ② 24 V supply & functional ground | ⑤ Unused |
| ③ Unused | ⑥ Unused |

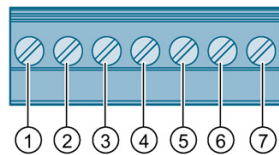

Pin	Label	Assignment
①		Not assigned
②		Not assigned
③	L+	24 V DC +/- 20 %
④	M	0 V DC reference
⑤	L+	24 V DC +/- 20 %
⑥	M	0 V DC reference
⑦	⏏	Functional ground

5.6.1.2 Connection to COM800 / COM100 via Ethernet

The DSP800 display is connected via the COM800 breaker data server to a total of eight 3VA molded case circuit breakers and via the COM100 breaker data server to one 3VA circuit breaker. The communication link is provided by an RJ45 patch cable connected between the Ethernet interface and the LAN interface of the DSP800.

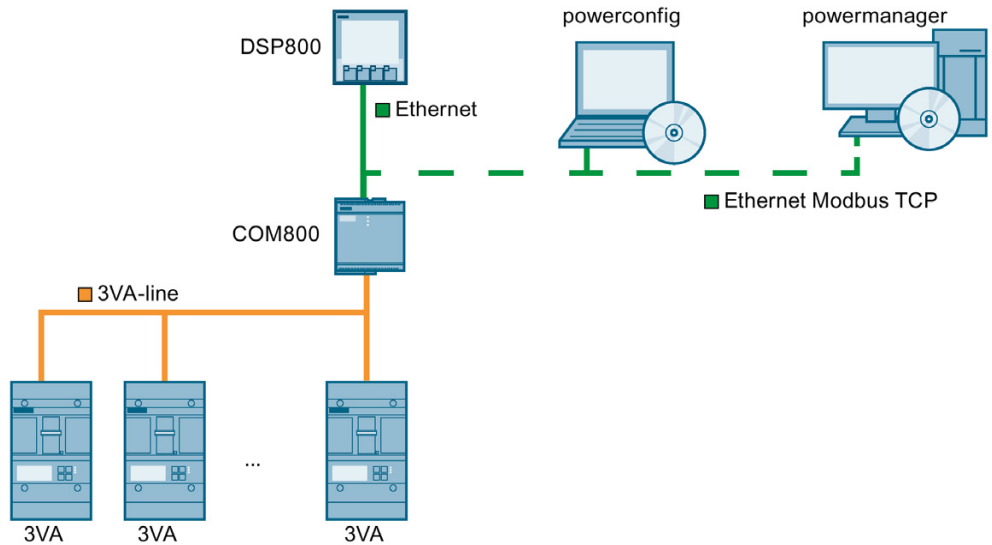

Using a standard Ethernet network, the breaker can communicate via the COM800 / COM100 breaker data server, e.g. with powerconfig and powermanager, in parallel with its communication with the DSP800.

Communication is also possible in parallel with DSP800 via the 7KM PAC PROFIBUS DP, 7KM PAC PROFINET or 7KM PAC RS 485 expansion modules.

The DSP800 can only be connected to the COM800 / COM100 via the integrated Ethernet connection.

5.6.2 Operator controls

The DSP800 display is operated by means of 4 keys (F1 to F4).



By means of these keys it is possible to select individual menus or menu items.

Buttons	Function keys	Description
	F1	Exit current menu
	F2	Move selection cursor up
	F3	Move selection cursor down
	F1	Go to detail menu
	F4	Go to selection menu
	F4	Select current view
	F4	Change to write mode
	F2	Raise current value by 1
	F3	Reduce current value by 1
	F4	Mark selected element
	F2	Move selection to right

5.6.3 Display

The DSP800 is a graphical LC display of size 74 x 58 mm [2.9 x 2.3 in].

A menu title, breaker identification, menu and submenu numbers appear at the top of the display.

The main area of the display shows a menu hierarchy as well as items of information about individual 3VA molded case circuit breakers.

Individual units of information such as states and measured values are displayed in the center.

At the bottom of the display, the function which can currently be performed by a function key is displayed above the relevant key.



You will find information about the menu hierarchy and the transitions between the individual views in chapter "Home menu (Page 146)".

See also

Operation (Page 146)

5.6.4 Commissioning

5.6.4.1 First commissioning

After the DSP800 display has powered up, the user interface language is English.

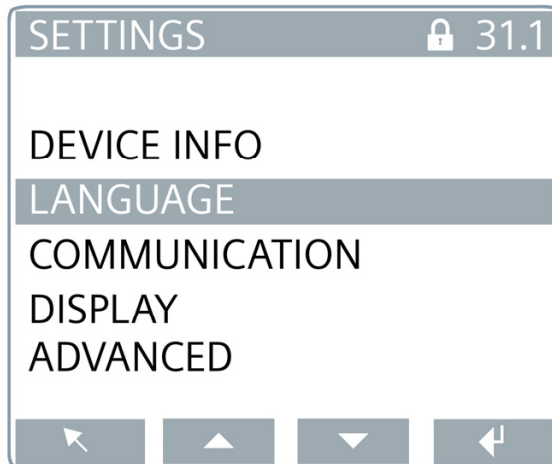

The DSP800 will need to be adapted depending on the intended application:

- Language setting
- Phase designation
- Adaptation to operating environment
- Input of communication parameters for the network environment and the connected COM800 / COM100 breaker data server

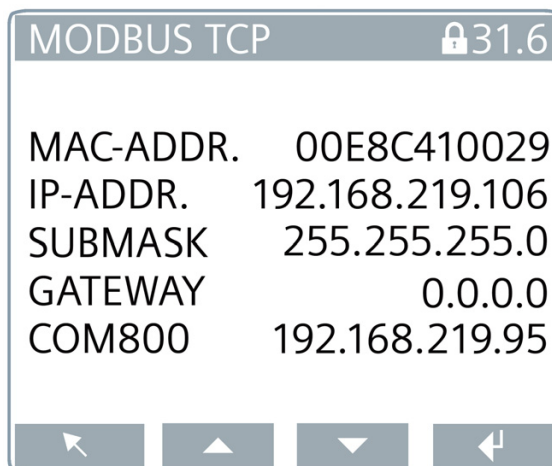

The following settings are possible or visible:

Address	Format	Description
MAC address		Read only
IP address		Must be unique within subnet.
Subnet		0 must be entered in positions that have address relevancy.
Gateway		Where known, otherwise 0.0.0.0
COM800/COM100 IP address		The address must be coordinated with other communication partners.

All properties of the DSP800 can be viewed in menu "Device Info". The data displayed by the DSP800 also includes a QR code.

IEC



UL



The QR code directs you to the address www.siemens.com/lvmobile?3VA9987-0TD10
 (www.siemens.com/lvmobile?3VA9977-0TD10)

The address for the UL product is www.siemens.com/lvmobile?3VA9977-0TD10
 (www.siemens.com/lvmobile?3VA9977-0TD10)

At these addresses you will find all relevant information about the DSP800 display including, for example, manuals, FAQs, etc.

5.6.4.2 Resetting

The DSP800 display can be reset in menu "Settings Advanced".

A password can be set in order to protect the DSP800 reset functions against unauthorized access. If password protection is activated, the correct password must be entered in order to reset the display.

It is possible to restore all the factory settings of the DSP800.

Alternatively, it is possible to restrict the reset operation to the communication settings in cases where, for example, the DSP800 is to be used in a different communication environment.

5.6.4.3 Commissioning with powerconfig

The DSP800 display can be commissioned with powerconfig.

The DSP800 is detected by means of the "Search for Accessible Devices (F11)" function and can be selected for parameterization.

When the "Activate blinking mode for selected device" function is selected, the screen of the DSP800 starts to flash for identification.

It is possible to enter the same settings in powerconfig as those set directly on the DSP800 unit. You can find more information on this in chapter First commissioning (Page 143).

The "Search for Accessible Devices (F11)" function can also be used to set the IP address and the subnet mask. In order to activate the changes, the inputs must be downloaded to the DSP800 with command "Apply Changes".

The "Create Devices" function is used to transfer the DSP800 to powerconfig.

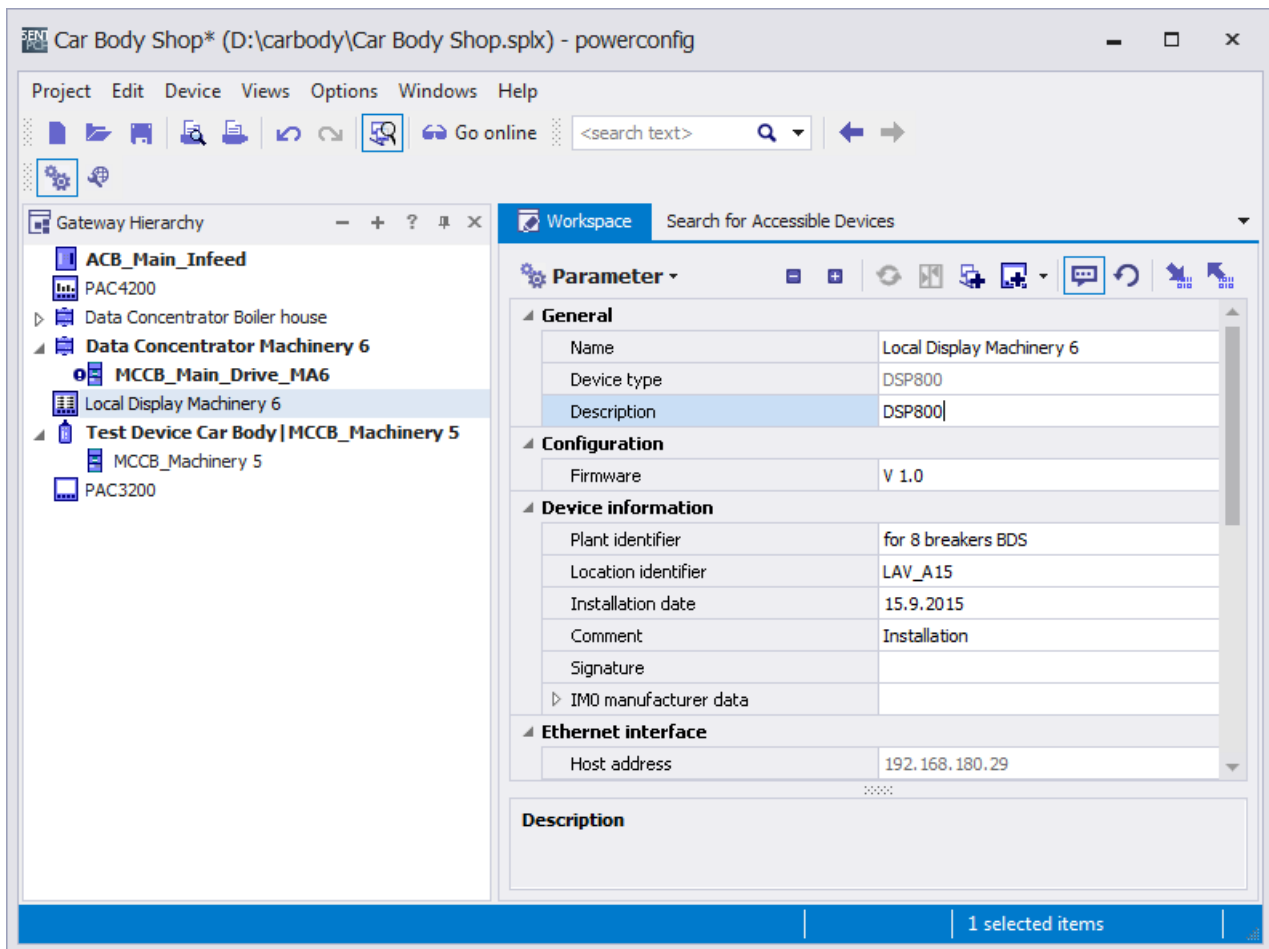

The DSP800 detects the assigned COM800 / COM100 breaker data server on the basis of the set IP address.

The IP addresses of the DSP800 display and the COM800 / COM100 breaker data server must be unique and set in the same subnet.

5.6.5 Operation

As soon as a communication link is established between the DSP800 display and the COM800 / COM100 breaker data server, the status of the active 3VA molded case circuit breakers is displayed in the main menu of the DSP800. You will find more information on this in chapter Switching state and accompanying information (Page 46).

5.6.5.1 Home menu

When the 3VA molded case circuit breaker is switched on, the breaker name and the current in the phase under the highest load are displayed.

S01 L1	173A	S05 L1	0.0A
S02 L1	0.5A	S06 L1	0.0A
S03 L1	OFF	S07 L1	OFF
S04 L1	TRIP	S08 L1	TRIP

The last three characters of the plant identifier are used as the breaker name if these have been assigned with powerconfig. The 3VA molded case circuit breakers are otherwise sorted in order of breaker addresses.

Note

When the DSP800 is used, it is advisable to assign plant identifiers in which the last 3 characters are different to individual 3VA molded case circuit breakers. The last 3 characters are displayed in the home menu and the breaker selection view.

If no plant identifiers have been assigned to the 3VA molded case circuit breakers, they are displayed in the home menu in order of breaker addresses and, in the breaker selection view, with the last 16 characters of the serial number. The serial number can be read out in powerconfig (View > 3VA > Parameters > Device Information > I&M Data COM060). The serial number is also printed on the label attached to the COM060.

If the 3VA molded case circuit breaker has tripped or is switched off, "OFF" or "TRIP" is displayed.

5.6.5.2 Navigation in the DSP800

When a 3VA molded case circuit breaker is selected, further information about the breaker is displayed. Starting from the home menu, it is possible to display various levels of detailed information about individual breakers.

The diagram below shows the information made available by the DSP800 and the options for navigation within and between menus.

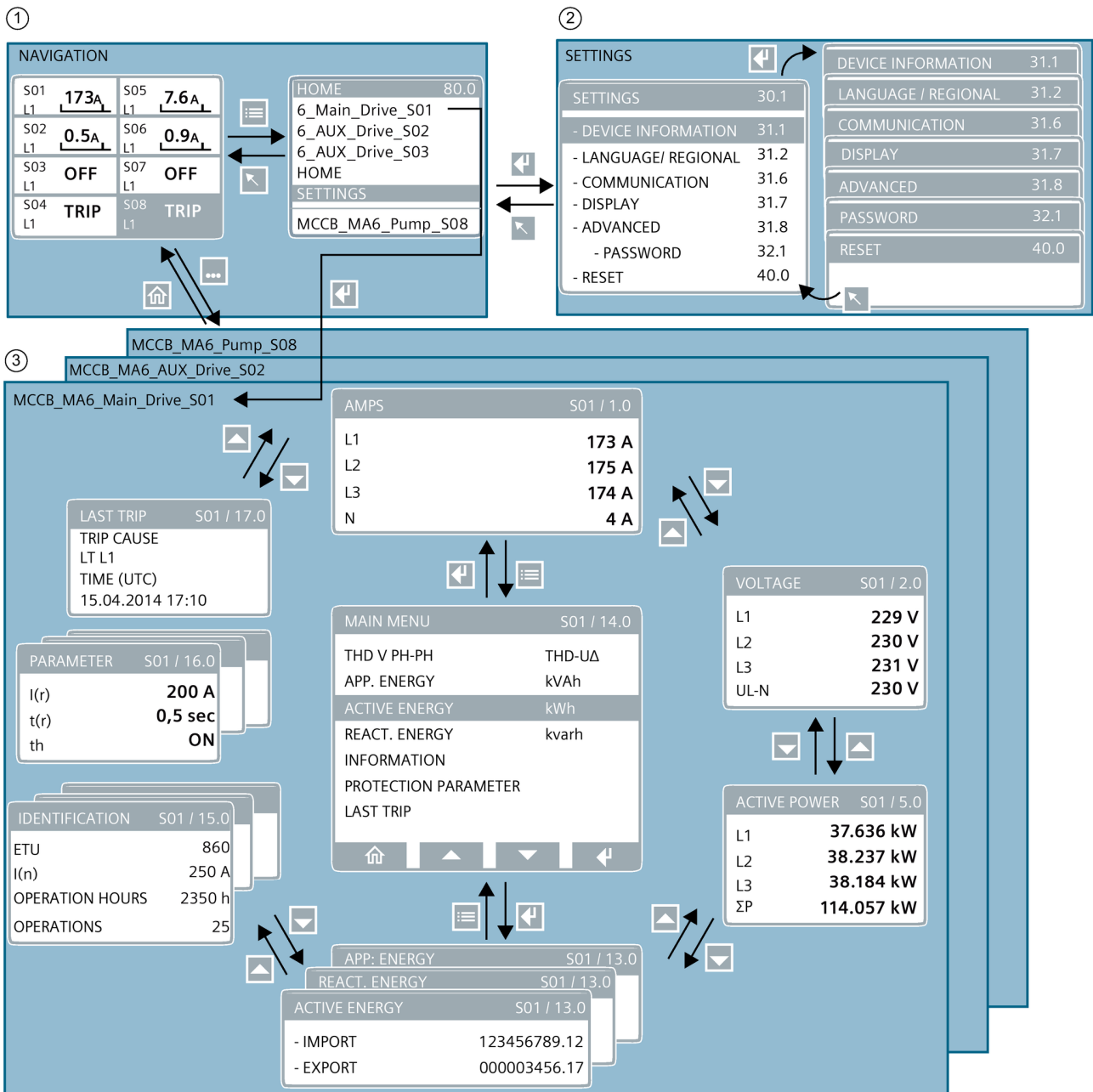

Key elements of the DSP800 display are

1. The overview in the home menu and breaker selection
2. The settings for language, communication, display and reset options
3. The information circle for each connected 3VA molded case circuit breaker

The information circle contains the measured variables of the relevant 3VA molded case circuit breaker and its identification. This includes information supplied by the manufacturer (Siemens) and by the user.

In addition, the protection parameter settings are displayed as well as the cause of the last trip of the relevant 3VA molded case circuit breaker.

5.7 TD500 test device

Using the mobile TD500 test device during the commissioning process, you can check that all system components connected to your 3VA molded case circuit breaker are functioning properly and correctly connected. It is possible to simulate various trip causes. The 3VA molded case circuit breaker responds as if the emergency were real – it trips in accordance with the set protection parameters and transmits all alarm and trip signals to the connected components.

The TD500 test device can be used as a mobile, hand-held test device and in conjunction with a PC. The TD500 test device is powered by the 12 V power pack supplied with the unit and is optionally connected to the PC via a USB cable.

The TD500 test device employs powerconfig as an interface to the 3VA molded case circuit breaker. powerconfig is able to archive all the protection parameters that were set during testing.

The TD500 can also be used to parameterize the EFB300, even when it is connected to ETUs 3-series. Furthermore, the parameters of the 3VA molded case circuit breaker and those of the ETUs 3-series can be read out and documented using the TD500.

The ETUs 5-series and 8-series can also be parameterized by means of the TD500.

5.7.1 Connecting

 DANGER
Hazardous voltage. Will cause death or serious injury.
Turn off and lock out all power supplying the breaker before working with the TD500 on the breaker.
Remove the TD500 and replace all covers before power supplying the breaker is turned on.
Connect up the test device in exactly the sequence described below.

Failure to connect the TD500 test device to the molded case circuit breaker according to the sequence of steps specified below can result in malfunctions and false test results.

For further information about the TD500 test device, refer to chapter "Test devices" of the manual for 3VA molded case circuit breakers.

Connecting the TD500 to the 3VA molded case circuit breaker

1. Disconnect the molded case circuit breaker from the power supply on all sides and all poles.
2. Insert the connecting cable in the socket on top of the TD500 test device.
3. Insert the connecting cable in the test socket of the ETU.
4. Insert the cable of the power supply unit in the socket on the bottom of the TD500 test device.
5. Connect the power supply unit to a socket.
The TD500 test device is now switched on and ready.
6. Press the pushbutton labeled <ON/OFF> on the TD500 test device.
The ETU is powered via the TD500 and is now activated.

Successful communication between the TD500 and ETU is indicated by illumination of the LED labeled "COM" on the TD500.

Disconnecting the TD500 from the 3VA molded case circuit breaker

1. Press the pushbutton labeled <ON/OFF> on the TD500 test device.
→ COM and Test LEDs go out
2. Unplug the TD500 at the ETU
3. If required connect the TD500 to other 3VA molded case circuit breakers.

5.7.1.1 PC connection

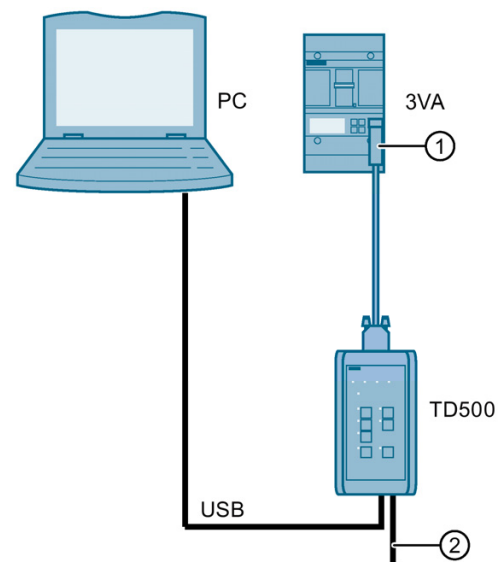

- ① TD500-to-ETU connector
- ② Connecting cable for power supply unit

5.7.2 Operator controls

The pushbuttons will indicate which tests are possible. These differ according to the type of ETU connected and its settings. The relevant test is carried out when the appropriate pushbutton is pressed.

Example: The L, S, I, N, G tripping functions, the transformers (TRANS), and the current meter (METER) can be tested on the ETU:

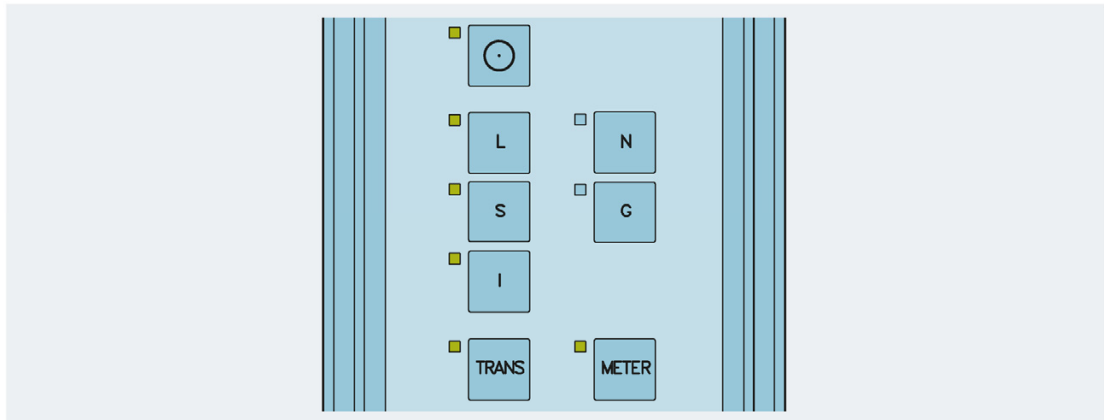





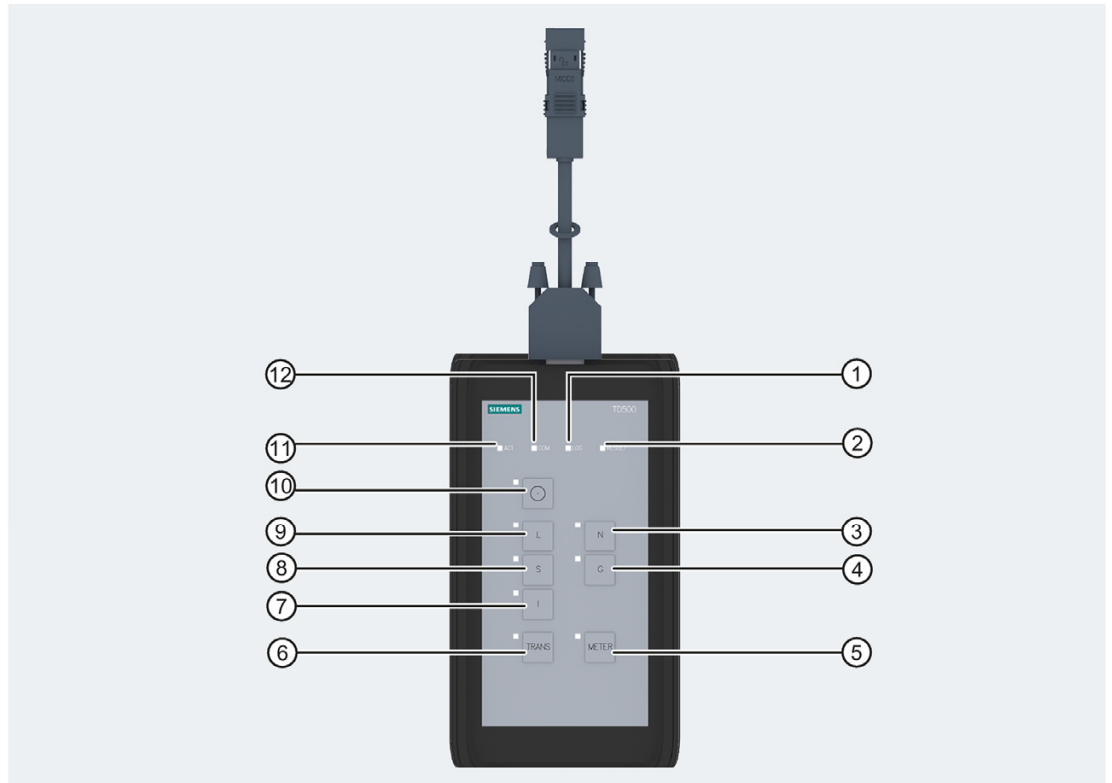

You can find further information in chapter "Test devices" of the manual for 3VA molded case circuit breakers.

5.7.2.1 LED displays



- | | |
|---|--|
| ① LED "LOG" (memory status) | ⑦ Pushbutton for instantaneous short-circuit trip test I |
| ② LED "RESULT" | ⑧ Pushbutton for short-time delayed short-circuit test S |
| ③ Pushbutton for neutral trip test N | ⑨ Pushbutton for overload trip test L |
| ④ Pushbutton for ground fault trip test G | ⑩ Pushbutton ON/OFF |
| ⑤ Pushbutton for meter test (current measurement display) | ⑪ LED "ACT" (status operating mode: ON = unit is ready) |
| ⑥ Pushbutton for transformer test | ⑫ LED "COM" (communication status) |

For an exact description of the meaning of individual LEDs, refer to the table below:

LED	Meaning	Description
<input type="checkbox"/> ACT	Off	TD500 switched off
 ACT	On	TD500 ready
<input type="checkbox"/> COM	Off	No communication link with ETU
 COM	Flashing (2 Hz)	- Establishing communication link with ETU - Communications error - TD500 not ready
 COM	On	Communication link established with ETU
<input type="checkbox"/> LOG	Off	No free memory space The TD500 device can continue to be used, but the results of the trip tests will no longer be stored on the TD500. The device is still capable of executing all test functions.
 LOG	Flashing (2 Hz)	Available memory space < 25 % The TD500 device can continue to be used without restriction, but there is only enough memory space available to store a few test results. In order to ensure safe storage of test results, save the existing results to a PC and delete the contents of the TD500 memory using powerconfig.
 LOG	On	Free memory space ≥ 25 % The TD500 device can continue to be used without restriction.
<input type="checkbox"/> RESULT	Off	No test has been carried out and no test result has been recorded.
 RESULT	Flashing red (2 Hz)	It has not been possible to establish whether or not the molded case circuit breaker is functioning correctly.
 RESULT	On	No faults have been detected.

5.7.3 Commissioning

5.7.3.1 First commissioning

When the TD500 test device is connected to the PC by means of the supplied USB cable, it will be detected automatically by powerconfig. No settings need to be made in advance.

5.7.3.2 Resetting

The TD500 test device can store more than 100 test operations. The available memory space is indicated by the "LOG" LED.

To erase the memory contents:

Select the relevant TD500 in powerconfig and navigate to menu item "Reset test log" via the "Device" menu

5.7.4 Operation

5.7.4.1 Execute a test with TD500

You can find information about test procedures using the TD500 test device in chapter "The TD500 test device" of the manual for 3VA molded case circuit breakers.

 **DANGER**









Hazardous voltage. Will cause death or serious injury.

Turn off and lock out all power supplying the breaker before working with the TD500 on the breaker.

Remove the TD500 and replace all covers before power supplying the breaker is turned on.

Connect up the test device in exactly the sequence described below.

5.7.4.2 Test with TD500 and powerconfig

1. Connect the TD500 to the 3VA molded case circuit breaker as described in chapter Connection (Page 148).
2. Connect the TD500 test device to the PC with powerconfig using the USB cable provided.
3. Drag the 3VA molded case circuit breaker from the library in the gateway hierarchy and drop it under the TD500 test device.
4. Select the TD500 test device and then select button **Breaker Tests** to open the view "Breaker tests".
5. Click on icon  in order to synchronize the TD500 test device with powerconfig. powerconfig displays all the supported tests for the relevant ETU.
6. Activate the tests by selecting icons L, to ME      .
7. Load the test data to the PC by selecting icon .

5.7.4.3 Evaluate tests with powerconfig

Test results can be evaluated by the method described below:

Display tested 3VA molded case circuit breakers

The individual results of tests carried out on a 3VA molded case circuit breaker are displayed in the form of test reports.

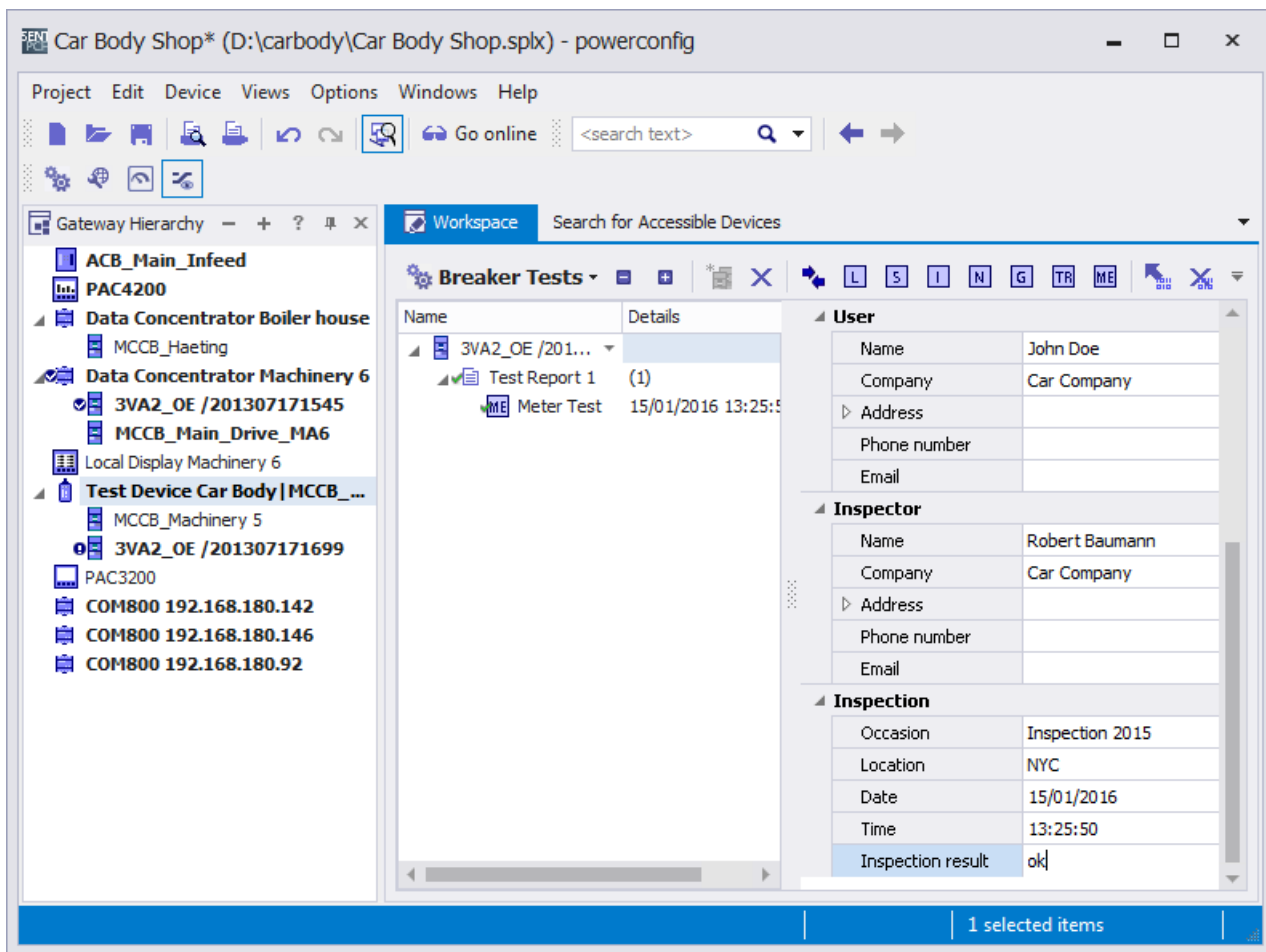

Archive test data

1. Load the test data into the PC (powerconfig) by selecting the icon .
2. Check the test data.
 - A test report contains:
 - Detailed test results in the 3VA (Ok, fault, aborted + accompanying values)
 - All valid parameter settings at the time of testing
 - Description (name, tester, etc.) - this information can be edited



Test data are thus archived in the project.

You can print out individual test reports by selecting the icon .

Transfer test reports to the project as 3VA configuration

- Individual test reports can be transferred to the project as a 3VA configuration.
- The icon  can be used to save test reports as a file in ".csv" format.
- 3VA configurations can be edited further (e.g. copied, duplicated or compared) in powerconfig after they have been transferred.
- Test reports are assigned to the TD500 test device. For this reason, you are recommended to position one test device in the project for every plant section in which the test reports are to be archived.

Delete test data

- A TD500 test device inserted in the project can be deleted again via the powerconfig menu "Device > Reset test log" .
→ All test data of the TD500 are then deleted. For this purpose, you must click on the icon  in the "Breaker tests" view of the TD500.
- You can delete individual test reports or entries by selecting the icon .

5.8 PROFIBUS DP expansion module

5.8.1 Connecting

5.8.1.1 Connecting the 24 V supply

The COM800 / COM100 breaker data server supplies power to the 7KM PAC PROFIBUS DP expansion module.

5.8.1.2 Connecting PROFIBUS DP

NOTICE**Voltage potential can damage communication module.**

- To avoid damage from active voltage, the system must be de-energized before installing the PROFIBUS DP expansion module.
- To avoid damage from the buildup of static charge, ensure there is no static buildup before touching the system components.

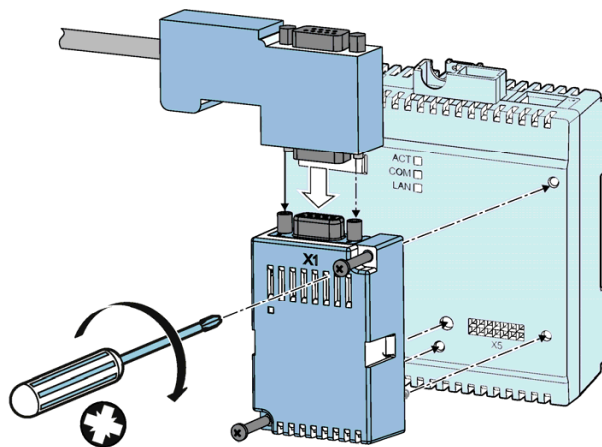

1. Ensure safe isolation from supply.
2. Make sure that you do not transfer any static charges to the device. Discharge the static electricity from your body before you touch the device.
3. Handle the 7KM PAC PROFIBUS DP expansion module by its plastic housing only.
4. Attach the 7KM PAC PROFIBUS DP expansion module to the COM800. The guide pins will ensure that the 7KM PROFIBUS DP is attached in the correct position.
5. Tighten the screws of the 7KM PAC PROFIBUS DP expansion module to a torque of 0.5 Nm [4.5 lb-in]. Plug the D-sub connector into the D-sub socket.
6. Screw the D-sub connector into place.
7. Provide sufficient mechanical strain relief for the PROFIBUS cable.
8. Ground the shield of the cable at both ends using a grounding clamp.

Note

Terminating resistor

When using the 7KM PAC PROFIBUS DP expansion module, observe the following:

- The specifications in the "PROFIBUS RS485-IS User and Installation Guideline"
 - The "SIMATIC NET PROFIBUS Network Manual"
-

Pin assignment for the PROFIBUS DP connection

The 7KM PAC PROFIBUS DP expansion module uses a 9-pin D-sub socket.

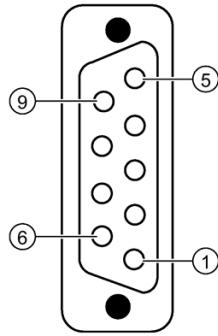









Pin	Designation	Meaning	Range
1	NC	Not assigned	-
2	NC	Not assigned	-
3	RxD / TxD-P	Receive/transmit data P	ANSI TIA/EIA-485-A
4	Control-P (RTS)	Control signal	TTL
5	DGND	PROFIBUS data reference potential	GND
6	VP	Power supply output	5 V _{ext} / 10mA
7	NC	Not assigned	-
8	RxD / TxD-N	Receive/transmit data N	ANSI TIA/EIA-485-A
9	NC	Not assigned	-

5.8.2 Operator controls

5.8.2.1 LED display

The LED display indicates the communication status.

LED	Status	Description	Measures
 Off	Off	No voltage connected to the 7KM PAC PROFIBUS DP expansion module	<ol style="list-style-type: none"> 1. Check whether the 7KM PAC PROFIBUS DP expansion module is correctly plugged into the COM800 / COM100 breaker data server. 2. Switch on the power supply to the COM800 / COM100 breaker data server.
 green	flashing (2 Hz)	PROFIBUS DP communications are OK. Data exchange with class 2 master.	–
 green	On	PROFIBUS DP communications are OK. Data exchange with class 1 master.	–
 red	flashing (2 Hz)	Parameter assignment error: <ul style="list-style-type: none"> • The slave has not been parameterized or has been wrongly parameterized. • An incorrect station address has been assigned. • An incorrect GSDML file has been used. 	<ol style="list-style-type: none"> 1. Check the communication and the parameter assignments. 2. Check the PROFIBUS address. 3. Check whether the GSD file matches the device, and firmware- and hardware version of the expansion module.
 red	On	Bus fault. Communication is not possible. No PROFIBUS DP communication with a class 1 or class 2 master.	7KM PAC PROFIBUS DP expansion module: <ol style="list-style-type: none"> 1. Use powerconfig to set a valid PROFIBUS address. 2. Check the bus installation. 3. Check whether the bus connector is correctly inserted. 4. Check whether the bus cable to the PROFIBUS DP master is interrupted or disconnected.
 orange	flashing (2 Hz)	Hardware fault on the expansion module or the COM800 / COM100 breaker data server, e.g.: <ul style="list-style-type: none"> • 12 V too weak or further internal faults 	Replace the module and/or the COM800 / COM100 breaker data server.
 orange	On	Communication fault between the module and the COM800 / COM100 breaker data server. The LED lights up for just a short time (e.g. during initialization) The LED turns green when communication has been restored.	Check whether the COM800 / COM100 breaker data server is functioning correctly. The usual diagnostics options on the master, e.g., error OB8x, are available for use.
		The LED lights up orange for a prolonged period: An internal fault has occurred.	Restart the device. Replace the module and/or the COM800 / COM100 breaker data server.
 green, red, orange	flashing (2 Hz)	A firmware update is in progress.	Do not abort the firmware update! The update will take between 8 and 13 minutes.

5.8.3 Commissioning

5.8.3.1 First commissioning

Factory settings of the 7KM PAC PROFIBUS DP expansion module

Parameter	Value
Address	126
Baud rate in bit/s	Automatic recognition
Type of connected device	Automatic recognition

With these factory settings, the 3VA molded case circuit breaker can be accessed via PROFIBUS from STEP 7, the TIA portal and powerconfig.

To activate the PROFIBUS DPV1 expansion module on the COM800 / COM100 breaker data server, the module must be selected at the expansion slot.

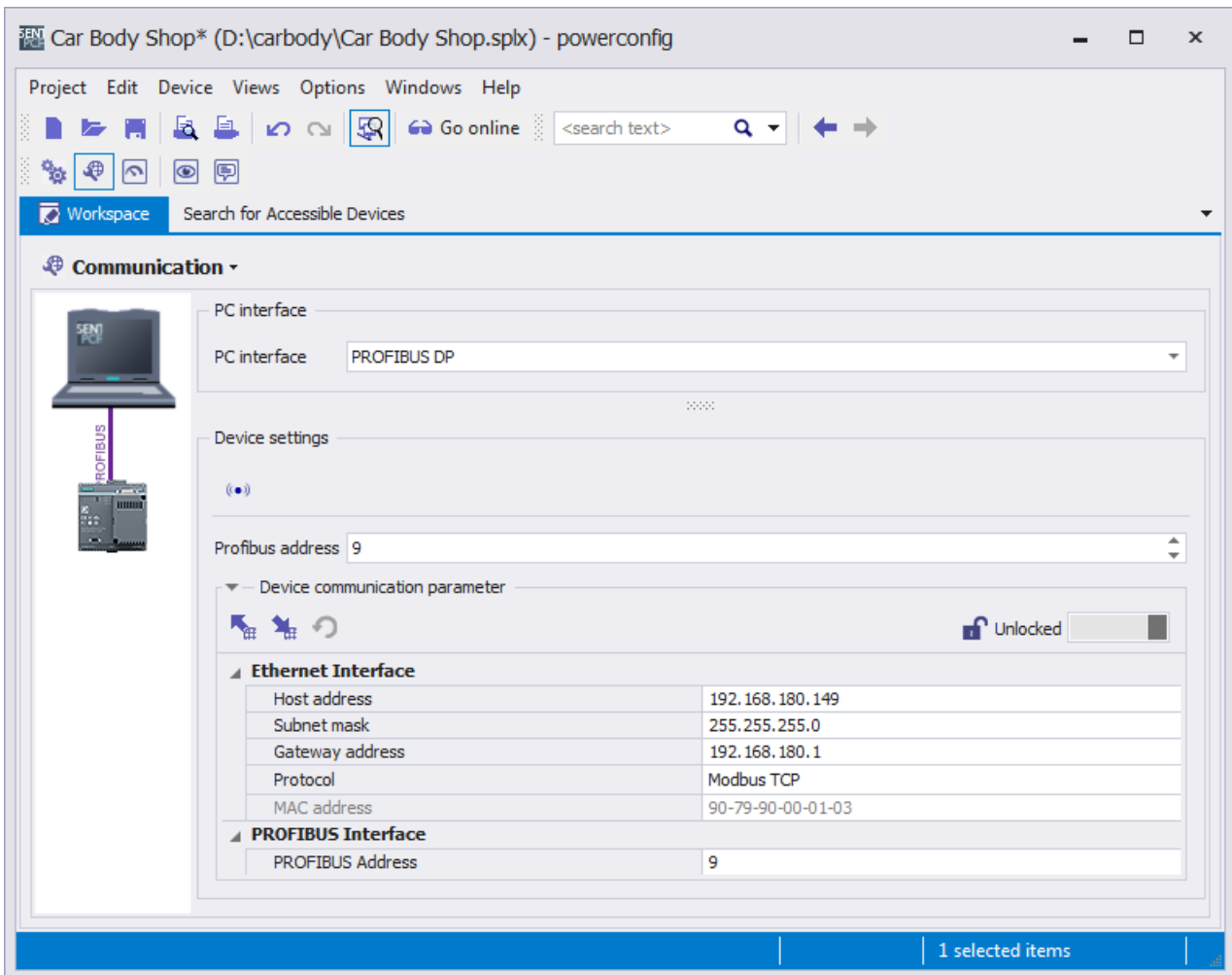

Changing the address of the 7KM PAC PROFIBUS DP expansion module

Each device requires a unique address in the range between 1 and 125. The address is stored in the 7KM PAC PROFIBUS DP expansion module. Address 126 is used for commissioning purposes only. It must not be used for data communication.

Change the address of each device before you begin transferring data. You can change the address:

- With powerconfig via the view: Communication
- With the PROFIBUS configuring software, e.g. TIA Portal, STEP 7, ...
- Via the PROFIBUS interface by means of a PROFIBUS DP class 2 master

If a 7KM PAC PROFIBUS DP expansion module is used by a PROFIBUS master, the PROFIBUS address cannot be set.

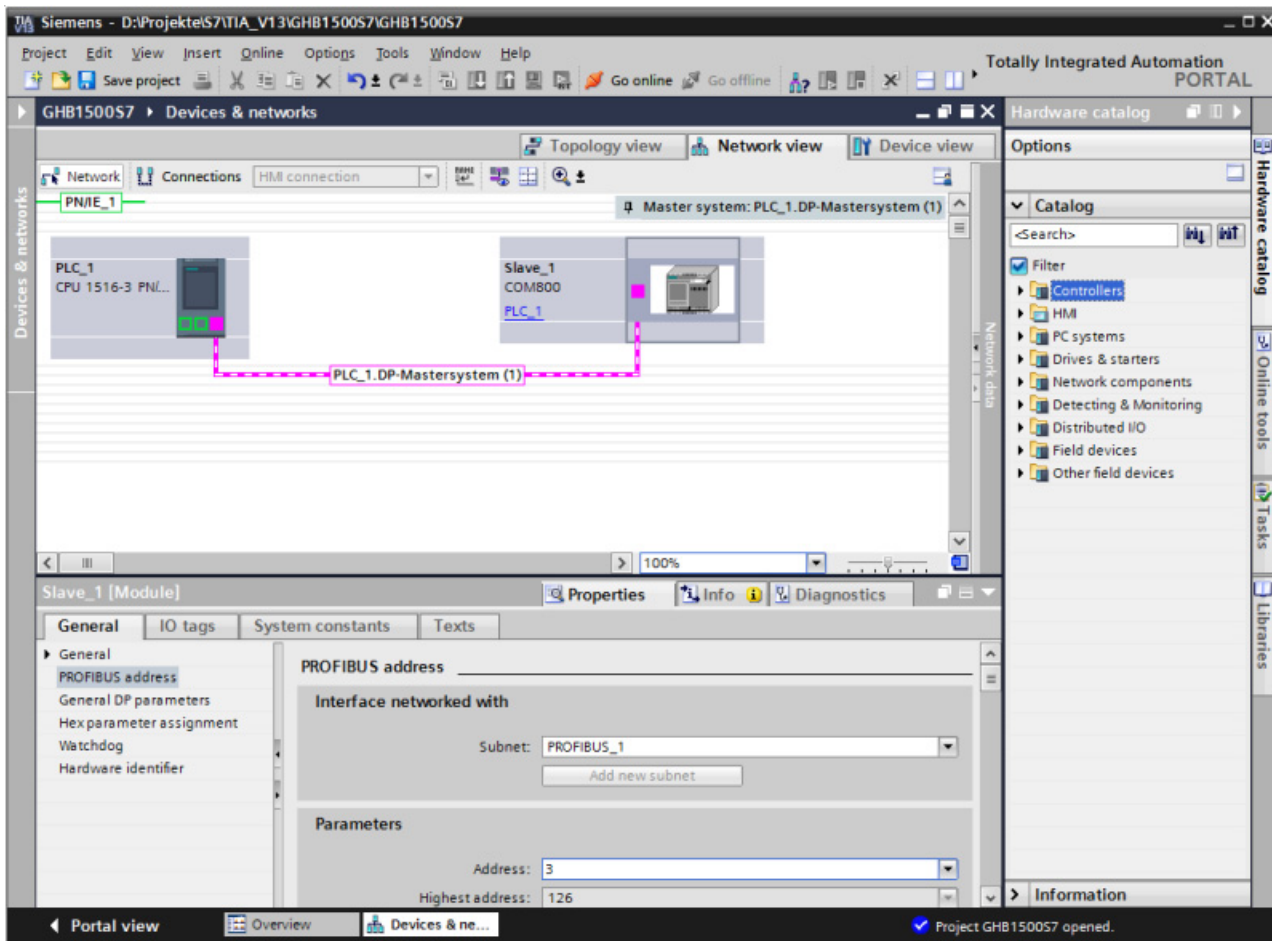

5.8.3.2 Resetting

Reset is accomplished by assigning a new PROFIBUS address.

Either the address of the expansion tool must be reset to 126 or the set address must be known.

5.8.3.3 Commissioning

Configuration scenario

In the SIMATIC environment, 3VA molded case circuit breakers can be integrated via PROFIBUS by means of STEP 7 and the device-specific GSD file.

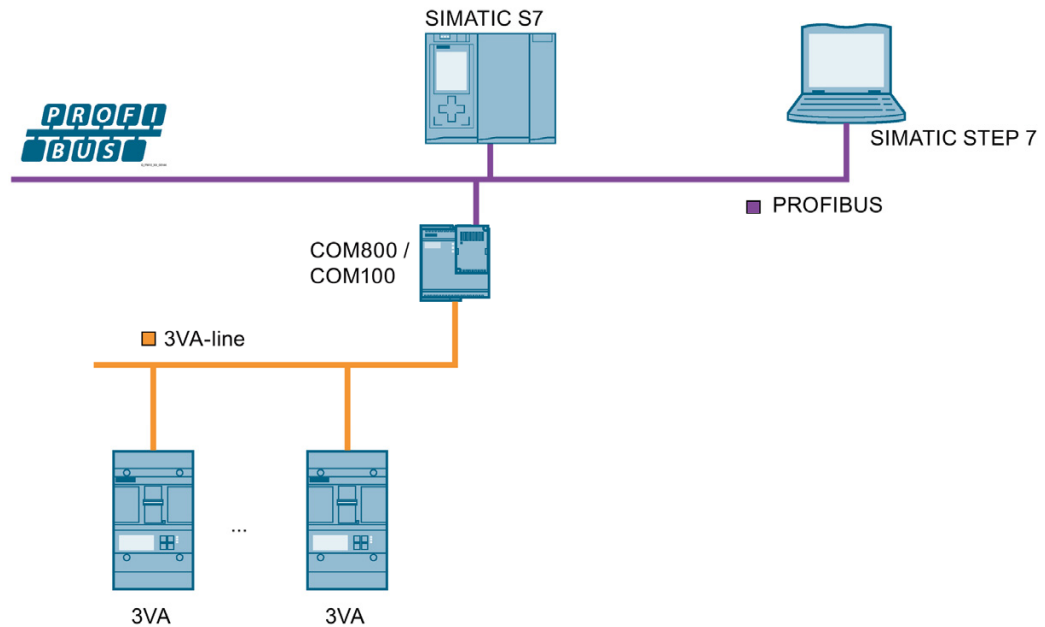

Note

Configuration with other tools

Configuration tools developed by other manufacturers can also be used.

Configuring with the GSD file

The GSD file forms the basis for the configuration of a device. Each PROFIBUS device has a PROFIBUS identification number and a GSD file created for a specific 3VA molded case circuit breaker.

The GSD file for PROFIBUS is a text file in ASCII format and defines the following for a 3VA molded case circuit breaker:

- Individual data structures (basic types)
- Characteristics
- Control data
- Status information

The basic types provide data in accordance with the Profiles for Low Voltage Switchgear Devices (LVSG), and they make this data available to the PROFIBUS DP class 1 master.

Naming convention of the PROFIBUS GSD file

The name of the GSD file contains the following information:

Places	Meaning
1 ... 2	"SI" for Siemens
3 ... 4	Version of the GSD file, e.g. "01" for the first version
5 ... 8	Identification number; this is assigned by PI

Assignment of a PROFIBUS GSD file to a device and firmware version of the expansion module

- Current version of the GSD file
You can find the current version of the GSD file at Industry Online Support under "GSD files (<https://support.industry.siemens.com/cs/ww/en/view/84054777>)". Save the GSD file on your PC for future use.

Further information

You can find further information about using the 7KM PAC PROFIBUS DP expansion module in chapter PROFIBUS DP (Page 163) and in the manual for the 7KM PAC PROFIBUS DP expansion module (<http://support.automation.siemens.com/WW/view/en/26504372>).

5.8.3.4 PROFIBUS DP

The COM800 breaker data server represents a total of eight 3VA molded case circuit breakers in a single PROFIBUS DPV1 slave, while the COM100 breaker data server represents only one 3VA breaker.

The configuration of the COM800 / COM100 breaker data server with the 3VA molded case circuit breakers is modeled as a modular device. Individual components can be addressed as slots and therefore have their own I&M data.

The component sequence is depicted in the screenshot below:

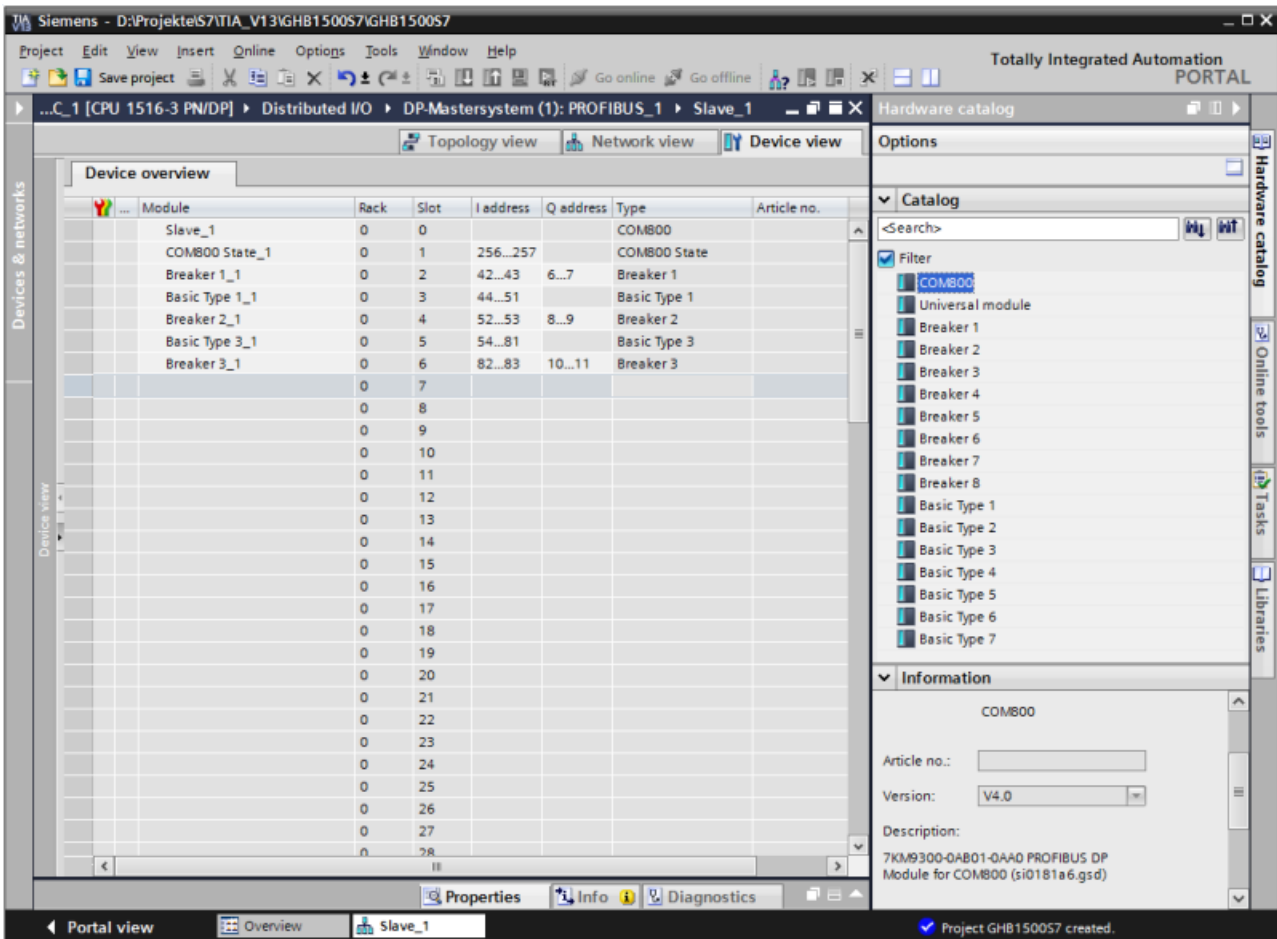

- COM800 / COM100 breaker data server
- 3VA molded case circuit breakers (= breakers 1 to 8)
 - Basic types 1 to 7
 - Control and status bytes (are inserted when the 3VA is created)

Only 3VA molded case circuit breakers with a breaker address between 1 and 8 can be addressed via PROFIBUS DP. PROFIBUS DP cannot address 3VA molded case circuit breakers with a breaker address of > 8.

When the COM800 / COM100 breaker data server is set up, it is possible to choose whether

- power-up should take place if the TARGET configuration does not match the ACTUAL configuration
- diagnostic interrupts should be employed
- process interrupts should be employed

In addition, the energy values of the 3VA molded case circuit breakers with ETUs 8-series can be read out by means of acyclic data exchange. See also chapter Acyclic communication via PROFIBUS DP (Page 170).

5.8.4 Operation

There are three possible methods to communicate with 3VA molded case circuit breakers via PROFIBUS DP during operation:

- Cyclic
- Acyclic
- Interrupts and diagnosis

You can find more information in the Manual "7KM PAC PROFIBUS DP, 7KM PAC SWITCHED ETHERNET expansion modules

(<http://support.automation.siemens.com/WW/view/en/26504372>)"

5.8.4.1 Cyclic communication via PROFIBUS DP

Cyclic communication permits continuous transfer of data, such as status and measured values, from the 3VA molded case circuit breaker. Switching and reset commands can be executed by means of simple binary operations.

The basic types, control bytes and status bytes conform to the following specifications:

Profiles for Low Voltage Switchgear Devices (LVSG) Technical Specification for PROFINET IO and PROFIBUS Version 1.32 - Date January 2013 Order No.: 3.122

The basic types are made available in the GSD file for configuring the PROFIBUS DP master.

Binary status information is created automatically when each circuit breaker is set up.

If one of the basic types 1, 2 or 3 is inserted immediately after the status information, the combination complies with the "Profiles for Low Voltage Switchgear Devices (LVSG) Technical Specification for PROFINET IO and PROFIBUS Version 1.32 - Date January 2013 Order No.: 3.122" which is also supported by 3WL and 3VL circuit breakers.

Status bytes

The following status bytes are available for each 3VA molded case circuit breaker:

Byte	Bit	Value	Information about 3VA molded case circuit breaker	ETU 8-series	ETU 5-series	DO ¹	SEO
0	0, 1	0	Disconnected position				
		1	Connected position	■	■	✓	-
		2	Test position				
		3	Not available				
	2, 3	0	Not ready				
		1	Off	■	■	■	■
		2	On				
		3	Has tripped				
	4	1	Reserved				
	5	1	Reserved	-	-	-	-
6	1	Spring energy store is compressed	■	■	■	✓	
7	1	Overload alarm present	✓	✓	-	-	
1	0	1	Reserved				
	1	1	Reserved				
	2	1	Write protection activated	■	■	-	-
	3	1	Reserved				
	4, 5, 6	0 ... 7	Reason for last trip				
		0	No tripping operation or last tripping operation acknowledged				
		1	Overload tripping (L)				
		2	Instantaneous short circuit (I)				
		3	Short-time delayed short circuit (sd)	✓	✓	-	-
		4	Ground fault (G)				
		5	Tripping operation as a result of extended protection function				
6	Overload in neutral conductor (N)						
7	1	Reserved					
7	1	Load shedding alarm	✓	✓	-	-	

- ¹ Draw-out unit
- ✓ Relevant for
- Available
- Not applicable

Availability via PROFIBUS DP of 3VA molded case circuit breakers linked to COM800 / COM100

The following status bytes of the COM800 / COM100 breaker data server signal the availability or non-availability of 3VA molded case circuit breakers linked to the breaker data server:

Byte	Bit	Value	3VA molded case circuit breaker with breaker address
0	0 ... 7	1	Available
	0	1	1
	1	1	2
	2	1	3
	3	1	4
	4	1	5
	5	1	6
	6	1	7
1	0 ... 7	1	Not available
	0	1	1
	1	1	2
	2	1	3
	3	1	4
	4	1	5
	5	1	6
	6	1	7
	7	1	8

Basic types 1 to 3

The cyclic IO data of 3VA molded case circuit breakers are grouped into seven different basic types. Each basic type supplies key items of information about a 3VA molded case circuit breaker in a level of detail and data format which vary according to the basic type.

The basic types are made available in the GSD file for configuring the PROFIBUS DP master.

Basic type 1 (LVSG format 1)

Byte	Data content	Format	Unit	ETU 8-series	ETU 5-series
0 ... 1	Current in phase L ₁	U16	A	✓	✓
2 ... 3	Current in phase L ₂	U16	A	✓	✓
4 ... 5	Current in phase L ₃	U16	A	✓	✓
6 ... 7	Current in phase under highest load	U16	A	✓	✓

✓ Relevant for

Basic type 2 (LVSG format 2)

Byte	Data content	Format	Unit	ETU 8-series	ETU 5-series
0 ... 1	Current in phase L ₁	U16	A	✓	✓
2 ... 3	Current in phase L ₂	U16	A	✓	✓
4 ... 5	Current in phase L ₃	U16	A	✓	✓
6 ... 7	Current in phase under highest load	U16	A	✓	✓
8 ... 9	Current in neutral conductor	U16	A	✓	✓
10 ... 11	Active energy import in 3 phases	U16	MWh	✓	-

✓ Relevant for

Basic type 3 (LVSG format 3)

Byte	Data content	Format	Unit	ETU 8-series	ETU 5-series
0 ... 1	Current in phase L ₁	U16	A	✓	✓
2 ... 3	Current in phase L ₂	U16	A	✓	✓
4 ... 5	Current in phase L ₃	U16	A	✓	✓
6 ... 7	Maximum current in phase under highest load	U16	A	✓	✓
8 ... 9	Current in neutral conductor	U16	A	✓	✓
10 ... 11	Voltage L ₁ -L ₂	U16	V	✓	-
12 ... 13	Voltage L ₂ -L ₃	U16	V	✓	-
14 ... 15	Voltage L ₃ -L ₁	U16	V	✓	-
16 ... 17	Voltage L ₁ -N	U16	V	✓	-
18 ... 19	Voltage L ₂ -N	U16	V	✓	-
20 ... 21	Voltage L ₃ -N	U16	V	✓	-
22 ... 23	Average power factor in 3 phases	U16	Factor 1000 of the actual value	✓	-
24 ... 25	Active energy import in 3 phases	U16	MWh	✓	-
26 ... 27	Apparent power Σ in 3 phases	U16	kVA	✓	-

✓ Relevant for
- Not applicable

Basic types 4 to 7

Measured variables are made available in FP32 format so that the data can be processed more simply and with a higher resolution in modern data processing systems and controllers.

Basic type 4

Byte	Data content	Format	Unit	ETU 8-series	ETU 5-series
0 ... 3	Current in phase L ₁	FP32	A	✓	✓
4 ... 7	Current in phase L ₂	FP32	A	✓	✓
8 ... 11	Current in phase L ₃	FP32	A	✓	✓
12 ... 15	Current in phase under highest load	FP32	A	✓	✓

✓ Relevant for

Basic type 5

Byte	Data content	Format	Unit	ETU 8-series	ETU 5-series
0 ... 3	Current in phase L ₁	FP32	A	✓	✓
4 ... 7	Current in phase L ₂	FP32	A	✓	✓
8 ... 11	Current in phase L ₃	FP32	A	✓	✓
12 ... 15	Current in phase under highest load	FP32	A	✓	✓
16 ... 19	Current in neutral conductor	FP32	A	✓	✓
20 ... 23	Active energy import in 3 phases	FP32	kWh	✓	-

✓ Relevant for

- Not applicable

Basic type 6

Byte	Data content	Format	Unit	ETU 8-series	ETU 5-series
0 ... 3	Current in phase L ₁	FP32	A	✓	✓
4 ... 7	Current in phase L ₂	FP32	A	✓	✓
8 ... 11	Current in phase L ₃	FP32	A	✓	✓
12 ... 15	Maximum current in phase under highest load	FP32	A	✓	✓
16 ... 19	Current in neutral conductor	FP32	A	✓	✓
20 ... 23	Active power in 3 phases	FP32	W	✓	-
24 ... 27	Reactive power in 3 phases	FP32	var	✓	-

✓ Relevant for

- Not applicable

Basic type 7

Byte	Data content	Format	Unit	ETU 8-series	ETU 5-series
0 ... 3	Current in phase L ₁	FLOAT32	A	✓	✓
4 ... 7	Current in phase L ₂	FLOAT32	A	✓	✓
8 ... 11	Current in phase L ₃	FLOAT32	A	✓	✓
12 ... 15	Current in phase under highest load	FLOAT32	A	✓	✓
16 ... 19	Current in neutral conductor	FLOAT32	A	✓	–
20 ... 23	Active energy import in 3 phases	FLOAT32	kWh	✓	–
24 ... 27	Average power factor in 3 phases	FLOAT32		✓	–

- ✓ Relevant for
- Not applicable

Control bytes

The following control bytes are available for each 3VA molded case circuit breaker:

Byte	Bit	Value	Activated function of the 3VA molded case circuit breaker
0	0,1	0 ... 3	Switch the 3VA molded case circuit breaker
		0	Not defined (no action)
		1	Switch off *)
		2	Switch on *)
	3	Not defined (no action)	
	2	1	Reset: Last trip reason
	3	1	Reserved
	4	1	Reserved
1	0,1	5	Reserved
		6	Reserved
		7	Reserved
		0	Reserved
	1	Reserved	
	2	Reserved	
	3	Reserved	
	2	1	Delete tripping and event recording
3	1	Reset minimum / maximum values	
4	1	Reserved	
5	1	Reserved	
6	1	Acknowledge maintenance information	
7	1	Reserved	

*) depending on use of SEO (Stored Energy Operator)

5.8.4.2 Acyclic communication via PROFIBUS DP

Using acyclic data exchange, it is possible on occasions to fetch larger volumes of data, such as the energy values for all breakers connected to the COM800 / COM100, from the 3VA molded case circuit breaker, or to control the molded case circuit breakers.

Reading data records DS205 and DS255

With 3VA molded case circuit breakers, data record DS205 is read using the CALL mechanism in a similar manner to the I&M data of DS255.

Note

Further information

You can find further information about the CALL mechanism in IEC 61158-6, Chapter 6, and the "PROFIBUS Profile Guideline Part 1: Identification & Maintenance Functions".

Writing data record DS93

By writing data record DS93, each 3VA molded case circuit breaker can be controlled via the control byte (see Control bytes, page 161), if the conditions are met on the 3VA.

The protocol sequences for "Read data record" (DS47) and "Write data record" (DS48) can be found in

Manual "7KM PAC PROFIBUS DP, 7KM PAC SWITCHED ETHERNET Expansion modules" (<https://support.industry.siemens.com/cs/ww/en/view/26504372>).

In addition, libraries are available for SIMATIC S7 and SIMATIC PCS 7 that make data available in the SIMATIC.

Control bytes DS93

The DP master can use data record DS93 to control the individual molded case circuit breakers connected to the COM800 / COM100 breaker data server. The data format corresponds to that of the control bytes of the "Profiles for Low Voltage Switchgear Devices (LVSG) Technical Specification for PROFINET IO and PROFIBUS Version 1.32 - Date January 2013 Order No.: 3.122"

Byte	Number of bits	Values	Format	Description
0	32		Struct	Header
4	32		Unsigned long	Reserved
8	16		Unsigned short	Reserved
10	2	0 ... 3		Switch the 3VA molded case circuit breaker
		0		No action
		1		Switch off *)
		2		Switch on *)
		3		Not defined, no action
	1	1		Reset: Last trip reason / Acknowledgment of the SEO
	1	1		Reserved
	1	1		Reserved
	1	1		Reserved
	1	1		Reserved
	1	1		Reserved
11	2			Reserved
		0		Reserved
		1		Reserved
		2		Reserved
		3		Reserved
	1			Delete tripping and event recording
	1			Reset minimum / maximum values
	1			Reserved
	1			Reserved
	1			Acknowledge the maintenance information
	1			Reserved
13	8			Reserved
Total bytes: 14				

*) Depending on the configuration

The data record is available for every 3VA case circuit breaker connected to a COM800 / COM100 breaker data server with the breaker addresses 1 ... 8.

Energy counter DS205

The DP master can use data record DS205 to read the energy counters of the 3VA molded case circuit breakers connected to the COM800 / COM100 breaker data server. The energy values are available in FP64 format (double float):

Byte	Number of bits	Format	Description
0	32	Struct	Header
4	32	U32	Reserved
8	16	U16	Reserved
10	64	FP64	Active energy import: 3VA molded case circuit breaker with breaker address 1
18	64	FP64	Reactive energy import: 3VA molded case circuit breaker with breaker address 1
26	64	FP64	Apparent energy: 3VA molded case circuit breaker with breaker address 1
34	64	FP64	Active energy import: 3VA molded case circuit breaker with breaker address 2
42	64	FP64	Reactive energy import: 3VA molded case circuit breaker with breaker address 2
50	64	FP64	Apparent energy: 3VA molded case circuit breaker with breaker address 2
58	64	FP64	Active energy import: 3VA molded case circuit breaker with breaker address 3
66	64	FP64	Reactive energy import: 3VA molded case circuit breaker with breaker address 3
74	64	FP64	Apparent energy: 3VA molded case circuit breaker with breaker address 3
82	64	FP64	Active energy import: 3VA molded case circuit breaker with breaker address 4
90	64	FP64	Reactive energy import: 3VA molded case circuit breaker with breaker address 4
98	64	FP64	Apparent energy: 3VA molded case circuit breaker with breaker address 4
106	64	FP64	Active energy import: 3VA molded case circuit breaker with breaker address 5
114	64	FP64	Reactive energy import: 3VA molded case circuit breaker with breaker address 5
122	64	FP64	Apparent energy: 3VA molded case circuit breaker with breaker address 5
130	64	FP64	Active energy import: 3VA molded case circuit breaker with breaker address 6
138	64	FP64	Reactive energy import: 3VA molded case circuit breaker with breaker address 6
146	64	FP64	Apparent energy: 3VA molded case circuit breaker with breaker address 6
154	64	FP64	Active energy import: 3VA molded case circuit breaker with breaker address 7
162	64	FP64	Reactive energy import: 3VA molded case circuit breaker with breaker address 7
170	64	FP64	Apparent energy: 3VA molded case circuit breaker with breaker address 7
178	64	FP64	Active energy import: 3VA molded case circuit breaker with breaker address 8
186	64	FP64	Reactive energy import: 3VA molded case circuit breaker with breaker address 8
194	64	FP64	Apparent energy: 3VA molded case circuit breaker with breaker address 8
Total	202		

Data record DS205 addresses the COM800 / COM100 breaker data server directly.

I&M device identification DS255

Data record DS255 contains the I&M data for the addressed component:

- COM800 / COM100 breaker data server
- 3VA molded case circuit breaker with breaker address 1
- ...
- 3VA molded case circuit breaker with breaker address 8

The record contains either device identification data or manufacturer information:

- I&M 0 (identification)

The record contains either maintenance data or device information:

- I&M 1 (plant identifier / location identifier)
- I&M 2 (installation date)
- I&M 3 (supplementary information)

Device identification data and maintenance data / device information are supplied in data record DS255.

See also

Measuring and visualizing energy data
(<https://support.industry.siemens.com/cs/ww/en/view/86299299>)

5.8.4.3 Access to all data

Block libraries and software packages for SIMATIC S7 are available for acyclic communication "Read/write data record". These make available all the measured variables and information about PROFIBUS DP given in chapter Functions (Page 41). The example application "Measuring and visualizing energy data (<https://support.industry.siemens.com/cs/ww/en/view/86299299>)" offers both blocks and faceplates for this purpose.

5.8.4.4 Interrupt and diagnosis concept with PROFIBUS DP

The purpose of diagnostic and process interrupts is to notify the DP master of sporadically occurring events. DP masters (such as SIMATIC S7) feature interrupt mechanisms designed to transfer standardized information to the user (program).

3VA molded case circuit breakers can output diagnostic functions compliant with PROFIBUS DPV0 and diagnostic and process interrupts compliant with PROFIBUS DPV1.

Communication between the breaker data server with DP (= DP slave) expansion module and the PROFIBUS master, e.g. SIMATIC S7 or PC, is based on the protocol sequences defined for PROFIBUS.

The data described below is made available to users through local interfaces.

In the SIMATIC environment, process interrupts are signaled via OB40 and diagnostic interrupts via OB82. Interrupt data can be read by means of SFB 54.

Diagnostic data for PROFIBUS DP V0

Position	Contents	Bit	Value	Contents	
Byte 0	Station status			Contents and values according to PROFIBUS Profile Guidelines Chapter 5.4	Slave diagnostics in accordance with standard
Byte 1					
Byte 2					
Byte 3	Master address				
Byte 4	Identification number (high)				
Byte 5	Identification number (low)				
Byte 6	Header		Type + length		
Byte 7	Status type		1		
Byte 8	Slot number		0 = Module 1 = COM800 2...x ^{*)}		
Byte 9	Specifier		1 = Incoming 2 = Outgoing		
Byte 10	User data 1	Bit0 ... 6	d.c.	Reserved	Device-specific diagnostic message
		Bit7	1	Diagnostic data available	
Byte 11	User data 2	Bit0	1	Communication with 3VA not yet ready	
		Bit1	1	Communication with 3VA not possible	
		Bit2	d.c.	Reserved	
		Bit3	1	Internal fault (CRC error)	
		Bit4	d.c.	Reserved	
		Bit5	1	Internal fault (frame error)	
		Bit6	1	Internal fault (timeout)	
		Bit7	1	C3VA and module firmware versions do not match. → Firmware needs to be updated.	
Byte 12	User data 3	Bit0	1	Voltage out of range	
		Bit1	1	Current out of range	
		Bit2	1	Pulse frequency too high	
		Bit3	1	Limit violation	
		Bit4 ... 7	d.c.	Reserved	
Byte 13	User data 4	Bit0	1	Digital outputs not remotely controllable	
		Bit1	d.c.	Reserved	
		Bit2	1	Energy counter write operation failed	
		Bit3	1	Write operation rejected due to write protection	
		Bit4	d.c.	Reserved	
		Bit5	1	Internal communication error	
		Bit6	1	Internal communication error	
		Bit7	1	Internal communication error	

*) Slot number of the breaker. See STEP 7 HW configuration

Diagnostic interrupt according to PROFIBUS DP V1

Position	Contents	Bit	Value	Contents			
Byte 0	Station status			Contents and values according to PROFIBUS Profile Guidelines	Slave diagnostics in accordance with standard		
Byte 1							
Byte 2							
Byte 3	Master address						
Byte 4	Identification number (high)						
Byte 5	Identification number (low)						
Byte 6	Header		Type + length				
Byte 7	Interrupt type		1				
Byte 8	Slot number		0 = Module 1 = COM800 2...x *)				
Byte 9	Specifier		1 = Incoming 2 = Outgoing				
Byte 10	Interrupt data 1	Bit0	1			Communication with COM not yet ready	Diagnostic interrupt
		Bit1	1			Communication with COM not possible	
		Bit2	d.c.	Reserved			
		Bit3	1	Internal fault (CRC error)			
		Bit4	d.c.	Reserved			
		Bit5		Internal fault (frame error)			
		Bit6	1	Internal fault (timeout)			
		Bit7	1	COM and module firmware versions do not match. → Firmware needs to be updated.			
Byte 11	Interrupt data 2	Bit0	d.c.	Voltage out of range			
Byte 12	Interrupt data 3	Bit0	1	Digital outputs not remotely controllable			
		Bit1	d.c.	Reserved			
		Bit2	1	Energy counter write operation failed			
		Bit3	1	Write operation rejected due to write protection			
		Bit4	d.c.	Reserved			
		Bit5	1	Internal communication error			
		Bit6	1	Internal communication error			
		Bit7	1	Internal communication error			

* Slot number of the breaker. See STEP 7 HW configuration

Process interrupt according to PROFIBUS DP

Position	Contents	Bit	Value	Contents		
Byte 0	Station status			Contents and values according to PROFIBUS Profile Guidelines	Slave diagnostics in accordance with standard	
Byte 1						
Byte 2						
Byte 3	Master address					
Byte 4	Identification number (high)					
Byte 5	Identification number (low)					
Byte 6	Header		6 = Without limit value setting 10 = With limit value setting			
Byte 7	Interrupt type		2			
Byte 8	Slot number		0 = Module 1 = COM800 2...x *)			
Byte 9	Specifier		1 = Incoming 2 = Outgoing			
Byte 10	Interrupt data 1	Bit0	1		Voltage out of range	Hardware interrupt
		Bit1	1		Current out of range	
		Bit2	1		Pulse frequency too high	
		Bit3	d.c.		Limit violation combination See bytes 12 to 15 for details	
		Bit4 ... 7	d.c.		Reserved	
Byte 11	Interrupt data 2		d.c.	Reserved		
Byte 12	Interrupt data 3	Bit0	1	Limit violation combination		
		Bit1	1	Status combination 1		
		Bit2	1	Status combination 2		
		Bit3	1	Status combination 3		
		Bit4	1	Status combination 2		
		Bit5 ... 7	d.c.	Reserved		
Byte 13	Interrupt data 4		d.c.	Reserved		
Byte 14	Interrupt data 5	Bit0	1	Limit violation 8		
		Bit1	1	Limit violation 9		
		Bit2	1	Limit violation 10		
		Bit3	1	Limit violation 11		
		Bit4 ... 7	d.c.	Reserved		
Byte 15	Interrupt data 6	Bit0	1	Limit violation 0		
		Bit1	1	Limit violation 1		
		Bit2	1	Limit violation 2		
		Bit3	1	Limit violation 3		
		Bit4	1	Limit violation 4		
		Bit5	1	Limit violation 5		
		Bit6	1	Limit violation 6		
		Bit7	1	Limit violation 7		

* Slot number of the breaker. See STEP 7 HW configuration

5.9 Switched Ethernet PROFINET expansion module

The 7KM PAC Switched Ethernet PROFINET expansion module is used to connect COM800 / COM100 breaker data servers to Switched Ethernet PROFINET via PROFINET IO, PROFINergy and Modbus TCP.

5.9.1 Connecting

5.9.1.1 Connecting the 24 V supply

The COM800 / COM100 breaker data server supplies power to the 7KM PAC Switched Ethernet PROFINET expansion module.

5.9.1.2 Connecting Switched Ethernet PROFINET

NOTICE

Voltage potential can damage communication module.

- To avoid damage from active voltage, the system must be de-energized before installing the 7KM PAC Switched Ethernet PROFINET expansion module.
- To avoid damage from the buildup of static charge, ensure there is no static buildup before touching the system components.

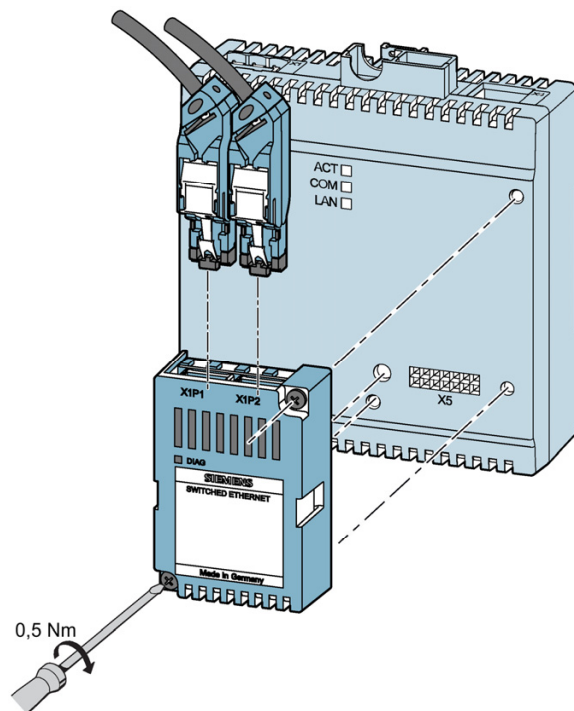









5.9 Switched Ethernet PROFINET expansion module

1. Ensure safe isolation from supply.
2. Make sure that you do not transfer any static charges to the device. Discharge the static electricity from your body before you touch the device.
3. Handle the 7KM PAC Switched Ethernet PROFINET expansion module by its plastic housing only.
4. Attach the 7KM PAC Switched Ethernet PROFINET expansion module to the COM800 / COM100. The guide pins will ensure that the 7KM Switched Ethernet PROFINET expansion module is attached in the correct position. Tighten the screws of the 7KM PAC Switched Ethernet PROFINET expansion module to a torque of 0.5 Nm [4.5 lb-in].
5. Plug the RJ 45 connectors into the RJ 45 sockets.
6. Provide sufficient mechanical strain relief for the Ethernet cable.
7. Ground the shield of the cable at both ends using a grounding clamp.

5.9.2 Operator controls

5.9.2.1 LED display

The LED display indicates the communication status.

LED	Status	Description	Measures
 white	Off	No voltage connected to the expansion module 7KM PAC Switched Ethernet PROFINET	<ol style="list-style-type: none"> 1. Check that the 7KM PAC Switched Ethernet PROFINET expansion module is correctly plugged into the COM800 / COM100 breaker data server. 2. Switch on the power supply to the COM800 / COM100 breaker data server.
 green	flashing (2 Hz)	PROFINET IO communication is OK. Data exchange with the PROFINET IO supervisor	–
 green	On	PROFINET IO communication is OK. Cyclic data exchange with the PROFINET IO controller	–
 red	flashing (2 Hz)	Parameter assignment error: <ul style="list-style-type: none"> • The device has not been parameterized or has been wrongly parameterized. • An incorrect station address has been assigned. • An incorrect GSDML file has been used. The red LED does not go off until a controller is connected to the network.	<ol style="list-style-type: none"> 1. Check the communication and the parameter assignments. 2. Check the station name and the IP address of the module. 3. Check whether the GSDML file matches the firmware version and the hardware version of the expansion module.
 red	On	No PROFINET IO communication with a PROFINET IO controller or a PROFINET IO supervisor	7KM PAC Switched Ethernet PROFINET expansion module: <ol style="list-style-type: none"> 1. Check the bus terminator. 2. Use powerconfig to set a valid station name. 3. If necessary, correct the IP settings. 4. Check whether the bus connector is correctly inserted. 5. Check whether the bus cable to the PROFINET IO controller is interrupted or disconnected.
 orange	flashing (2 Hz)	Hardware fault on the expansion module or the COM800 / COM100 breaker data server, e.g.: <ul style="list-style-type: none"> • 12 V too weak or not present • SRAM fault • Flash fault • EEPROM fault 	Replace the module and/or the COM800 / COM100 breaker data server.
 orange	On	Communication fault between the module and the COM800 / COM100 breaker data server. The LED lights up for just a short time (e.g. during initialization) The LED turns green when communication has been restored. The LED lights up orange for a prolonged period: An internal fault has occurred.	Check whether the COM800 / COM100 breaker data server is functioning correctly. The usual diagnostics options on the master, e.g., error OB8x, are available for use. Restart the device. Replace the module and/or the COM800 / COM100 breaker data server.
 green, red, orange	flashing (2 Hz)	A firmware update is in progress.	Do not abort the firmware update! The update will take between 8 and 13 minutes.

5.9.3 Commissioning

5.9.3.1 First commissioning

When the 7KM PAC Switched Ethernet PROFINET expansion module is set to its factory values, three MAC addresses are preset. Additional values can be set by the user during commissioning.

The following values can be set during commissioning:

- IP address
- Subnet mask
- Station name for PROFINET

If the 7KM PAC Switched Ethernet PROFINET expansion module is used exclusively for PROFINET, only the station name that is unique throughout the network must be assigned by means of the PROFINET configuring tool, e.g. TIA Portal.

The 7KM PAC Switched Ethernet PROFINET expansion module in the same subnet can be addressed by one of the following configuration programs via one of the three MAC addresses:

- STEP 7
- TIA Portal
- powerconfig

Example of address parameters (in powerconfig):

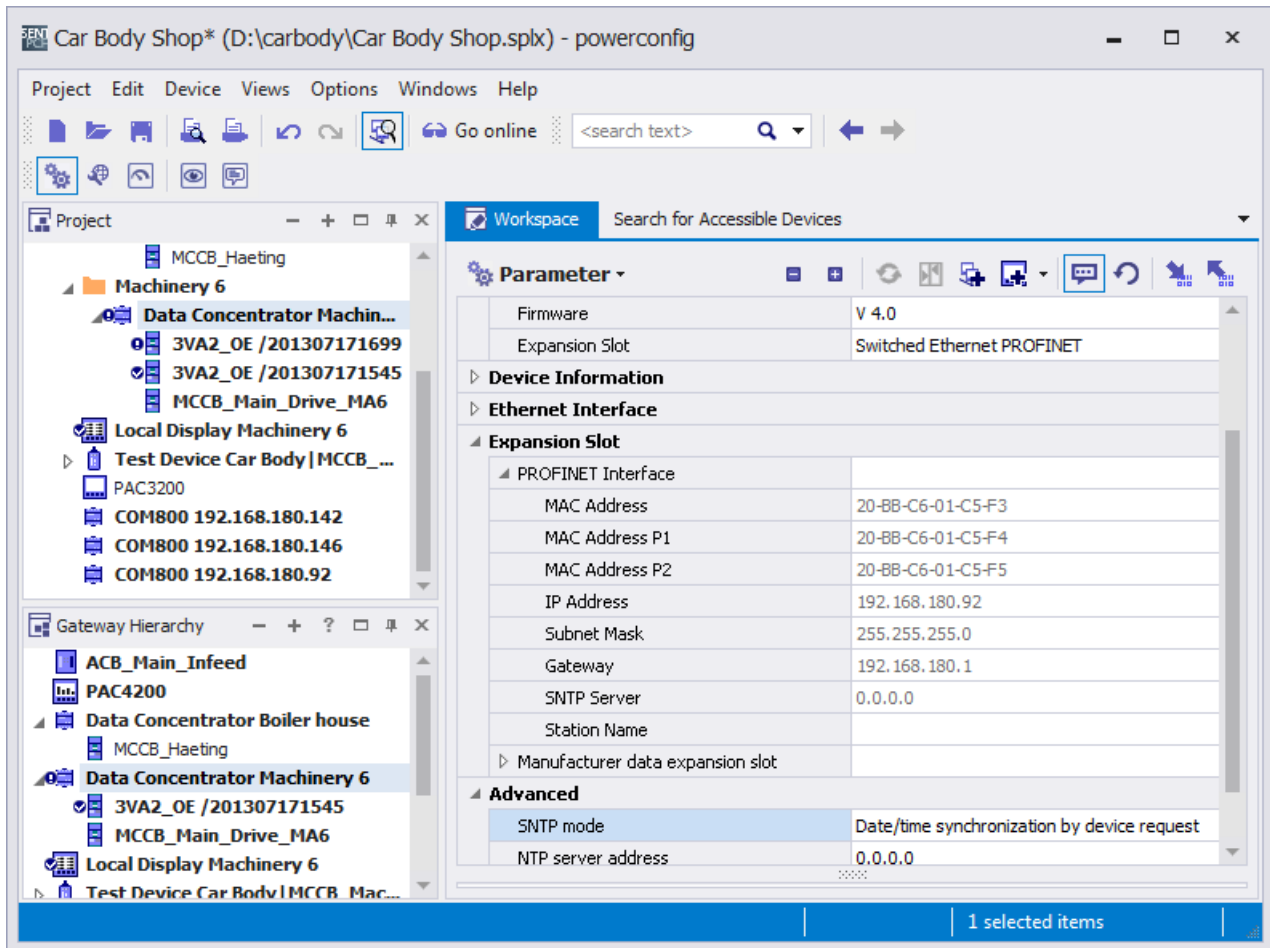

The 7KM PAC Switched Ethernet PROFINET expansion module requires PROFINET-compliant addressing information.

Change the address of the 7KM PAC Switched Ethernet PROFINET expansion module:

In order to change addresses, it is necessary to know the IP address or conduct a search for the 7KM PAC Switched Ethernet PROFINET expansion module in the same subnet using the icon .

The 7KM PAC Switched Ethernet PROFINET expansion module can be completely parameterized with STEP 7 as well as with powerconfig.

5.9.3.2 Resetting

The IP addresses and subnet mask of the 7KM PAC Switched Ethernet PROFINET expansion module can be changed as often as required.

The 7KM PAC Switched Ethernet PROFINET expansion module is reset when the addresses are changed.

5.9.3.3 Commissioning

Configuration scenario

In the SIMATIC environment, 3VA molded case circuit breakers can be integrated via PROFINET by means of STEP 7 or TIA Portal and the device-specific GSDL file.

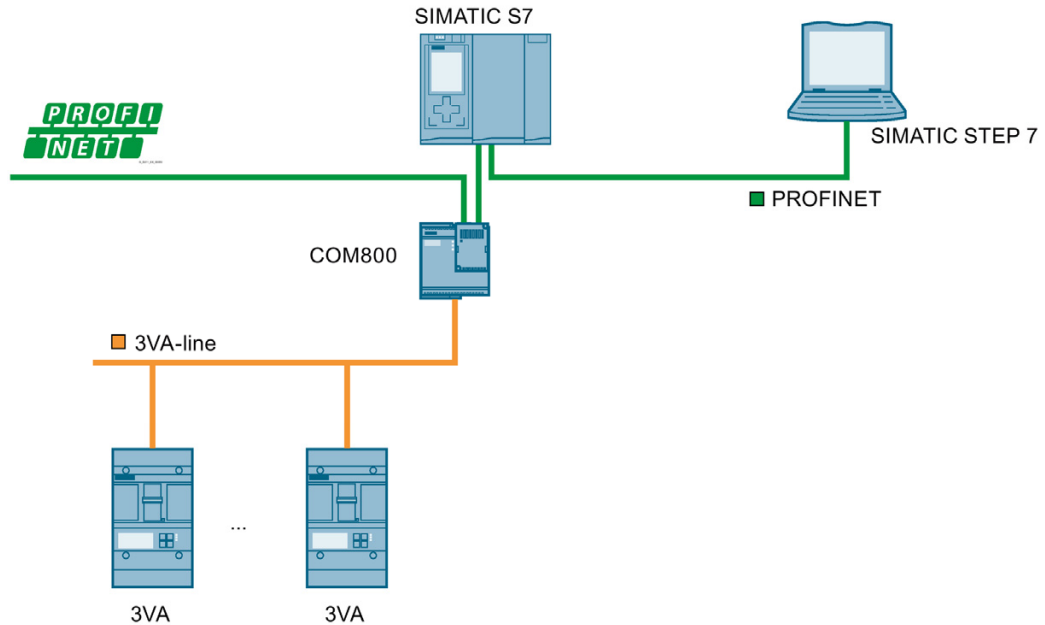

Note

Configuration with other tools

Configuration tools developed by other manufacturers can also be used.

Configuring with the GSDML file

The GSDML file forms the basis for the configuration of a device. Each PROFINET device has a PROFINET identification number and a GSDML file created for a specific 3VA molded case circuit breaker.

The GSDML file provides the following information for communication purposes:

- Individual data structures (basic types)
- Characteristics
- Control data
- Status information

The basic types provide the following data and make them available to the PROFINET IO controller:

- Measured variables

Note

Current version of the GSDML file

You can find the current version of the GSDML file (<http://support.automation.siemens.com/WW/view/en/59840946>) at Industry Online Support. Save the GSDML file on your PC for future use.

Further information

You can find further information about using the 7KM PAC Switched Ethernet PROFINET expansion module in the manual for the 7KM PAC Switched Ethernet PROFINET expansion module (<http://support.automation.siemens.com/WW/view/en/26504372>).

See also

PROFINET IO (Page 184)

5.9.3.4 PROFINET IO

The COM800 breaker data server represents a total of eight 3VA molded case circuit breakers in one PROFINET device.

The COM100 breaker data server represents a single 3VA molded case circuit breaker in one PROFINET device.

The configuration of the COM800 / COM100 breaker data server with the 3VA molded case circuit breakers is modeled as a modular device. Individual components can be addressed as subslots and therefore have their own I&M data.

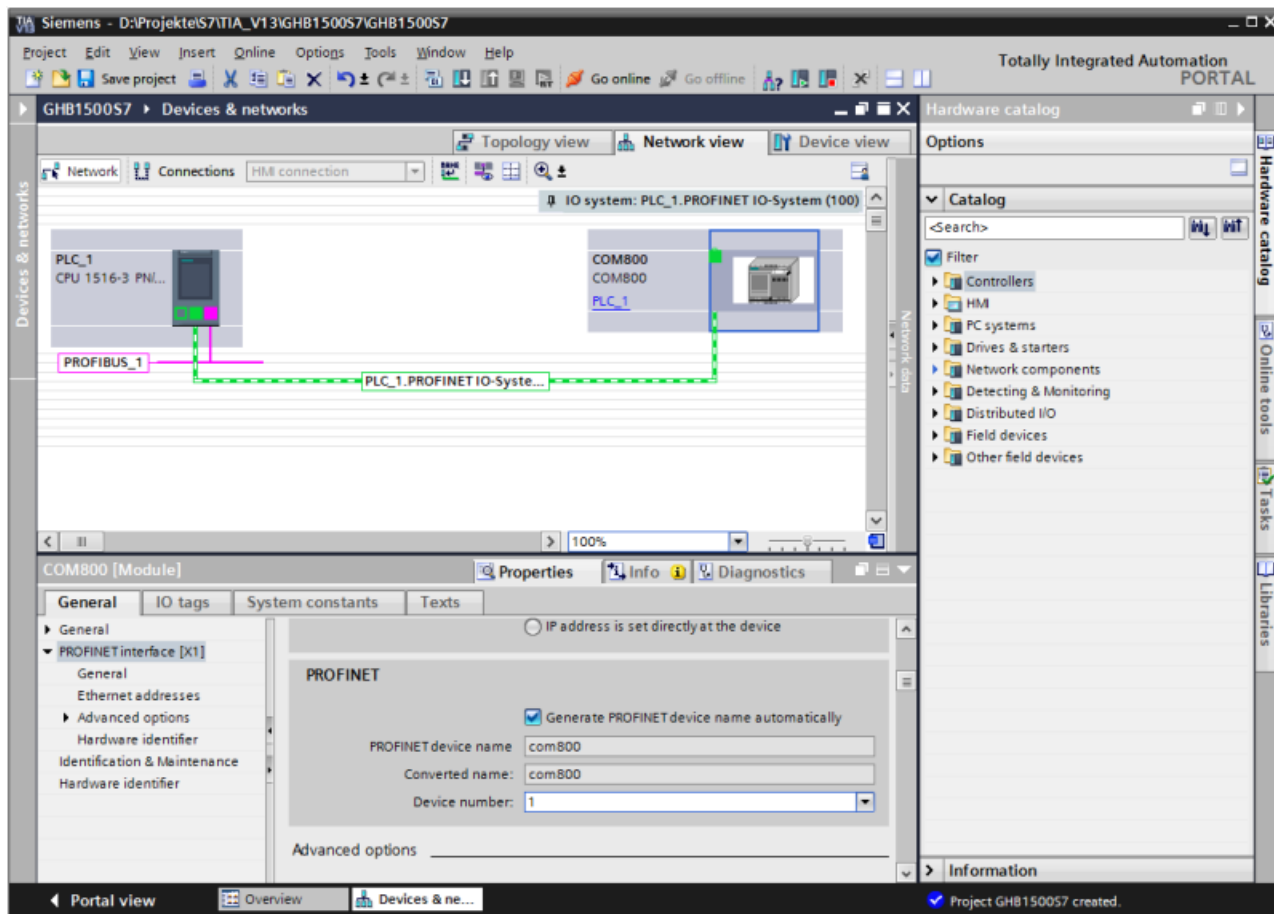

The following modules are mapped as slots and subslots in the GSDML file:

- COM800 / COM100 breaker data server
- 3VA molded case circuit breakers (= breakers 1 to 8)
 - Basic types 1 to 7
 - Control and status bytes

Only 3VA molded case circuit breakers with a breaker address between 1 and 8 can be addressed via PROFINET IO. PROFINET IO cannot address 3VA molded case circuit breakers with a breaker address of > 8.

With PROFINET IO it is possible to place a breaker in each of the 8 slots. The slot number corresponds to the real breaker address.

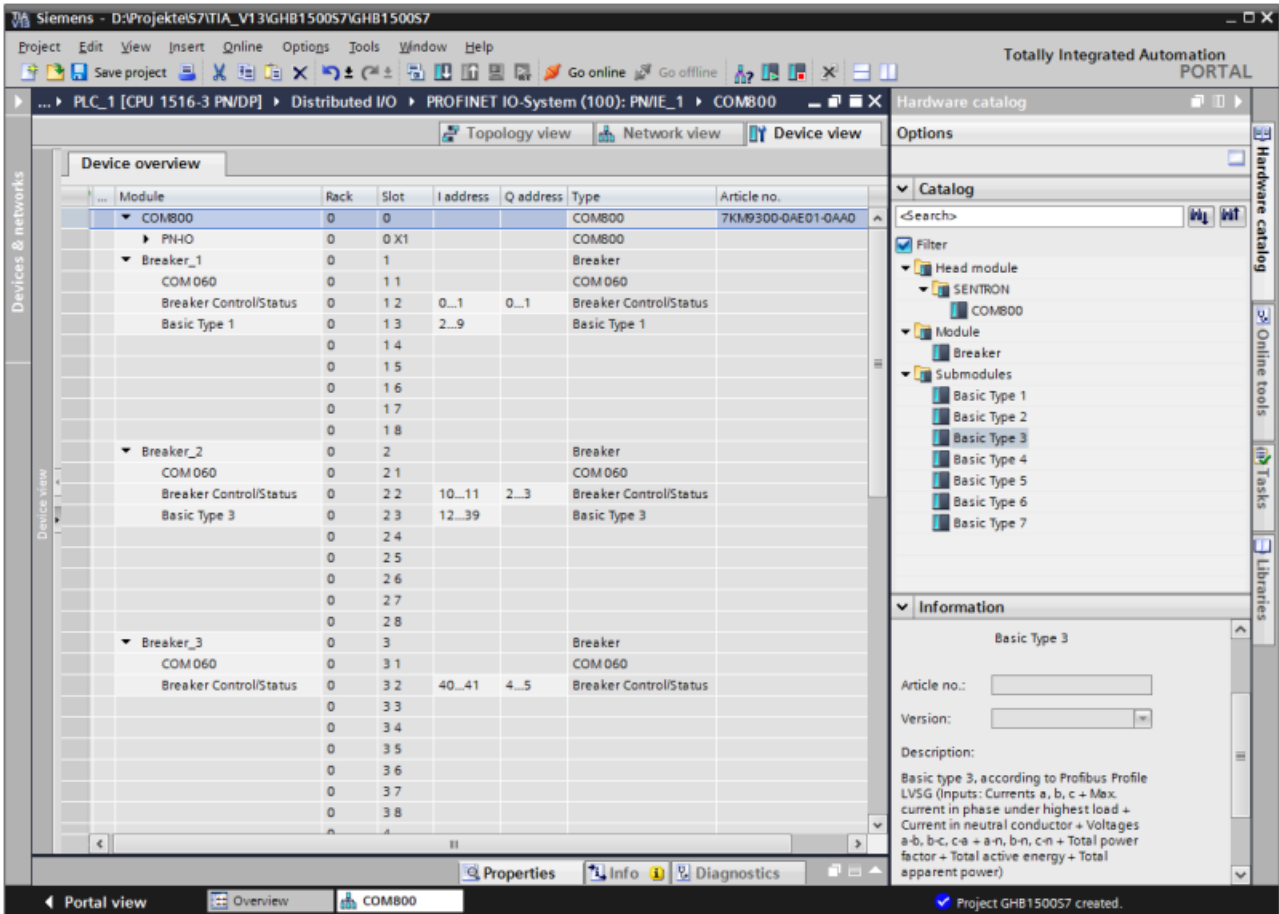

Up to 6 basic types (= subslots) can be placed within one slot.

No more than 240 bytes of input data (i.e. status bytes and basic types) may be used in total for all 8 breakers.

The measured variables of individual 3VA molded case circuit breakers can also be read via the Common Application Profile PROFIenergy. Refer to chapter PROFIenergy (Page 192).

5.9.4 Operation

There are four possible methods of communicating with 3VA molded case circuit breakers via PROFINET during operation:

- Cyclic
- PROFlenergy
- Acyclic
- Modbus TCP

5.9.4.1 Cyclic communication via PROFINET IO

Cyclic communication permits continuous transfer of data, such as status and measured values, from the 3VA molded case circuit breaker. Switching and reset commands can be executed by means of simple binary operations.

The basic types, control bytes and status bytes conform to the following specifications:

Profiles for Low Voltage Switchgear Devices (LVSG) Technical Specification for PROFINET IO and PROFIBUS Version 1.32 - Date January 2013 Order No.: 3.122

Binary status information is created automatically when each circuit breaker is set up.

If one of the basic types 1, 2 or 3 is inserted immediately after the status information, the combination complies with the "Profiles for Low Voltage Switchgear Devices (LVSG) Technical Specification for PROFINET IO and PROFIBUS Version 1.32 - Date January 2013 Order No.: 3.122" which is also supported by 3WL and 3VL circuit breakers.

Status bytes

The following status bytes are available for each 3VA molded case circuit breaker:

Byte	Bit	Value	Information about 3VA molded case circuit breaker	ETU 8-series	ETU 5-series	DO ¹	SEO
0	0, 1	0	Disconnected position				
		1	Connected position	■	■	✓	-
		2	Test position				
		3	Not available				
	2, 3	0	Not ready				
		1	Off	■	■	■	■
		2	On				
		3	Has tripped				
	4	1	Reserved				
	5	1	Reserved	-	-	-	-
6	1	Spring energy store is compressed	■	■	■	✓	
7	1	Overload alarm present	✓	✓	-	-	
1	0	1	Reserved				
	1	1	Reserved				
	2	1	Write protection activated	■	■	-	-
	3	1	Reserved				
	4, 5, 6	0 ... 7	Reason for last trip				
		0	No tripping operation or last tripping operation acknowledged				
		1	Overload tripping (L)				
		2	Instantaneous short circuit (I)				
		3	Short-time delayed short circuit (sd)	✓	✓	-	-
		4	Ground fault (G)				
		5	Tripping operation as a result of extended protection function				
6	Overload in neutral conductor (N)						
7	1	Reserved					
7	1	Load shedding alarm	✓	✓	-	-	

- ¹ Draw-out unit
- ✓ Relevant for
- Available
- Not applicable

Basic types 1 to 3

The cyclic IO data of 3VA molded case circuit breakers are grouped into seven different basic types. Each basic type supplies key items of information about a 3VA molded case circuit breaker in a level of detail and data format which vary according to the basic type.

The basic types are made available in the GSDML file for configuring the PROFINET IO controller.

Basic type 1 (LVSG format 1)

Byte	Data content	Format	Unit	ETU 8-series	ETU 5-series
0 ... 1	Current in phase L ₁	U16	A	✓	✓
2 ... 3	Current in phase L ₂	U16	A	✓	✓
4 ... 5	Current in phase L ₃	U16	A	✓	✓
6 ... 7	Current in phase under highest load	U16	A	✓	✓

✓ Relevant for

Basic type 2 (LVSG format 2)

Byte	Data content	Format	Unit	ETU 8-series	ETU 5-series
0 ... 1	Current in phase L ₁	U16	A	✓	✓
2 ... 3	Current in phase L ₂	U16	A	✓	✓
4 ... 5	Current in phase L ₃	U16	A	✓	✓
6 ... 7	Current in phase under highest load	U16	A	✓	✓
8 ... 9	Current in neutral conductor	U16	A	✓	✓
10 ... 11	Active energy import in 3 phases	U16	MWh	✓	-

✓ Relevant for

- Not applicable

Basic type 3 (LVSG format 3)

Byte	Data content	Format	Unit	ETU 8-series	ETU 5-series
0 ... 1	Current in phase L ₁	U16	A	✓	✓
2 ... 3	Current in phase L ₂	U16	A	✓	✓
4 ... 5	Current in phase L ₃	U16	A	✓	✓
6 ... 7	Maximum current in phase under highest load	U16	A	✓	✓
8 ... 9	Current in neutral conductor	U16	A	✓	✓
10 ... 11	Voltage L ₁ -L ₂	U16	V	✓	-
12 ... 13	Voltage L ₂ -L ₃	U16	V	✓	-
14 ... 15	Voltage L ₃ -L ₁	U16	V	✓	-
16 ... 17	Voltage L ₁ -N	U16	V	✓	-
18 ... 19	Voltage L ₂ -N	U16	V	✓	-
20 ... 21	Voltage L ₃ -N	U16	V	✓	-
22 ... 23	Average power factor in 3 phases	U16	Factor 1000 of the actual value	✓	-
24 ... 25	Active energy import in 3 phases	U16	MWh	✓	-
26 ... 27	Apparent power Σ in 3 phases	U16	kVA	✓	-

- ✓ Relevant for
- Not applicable

Basic types 4 to 7

Measured variables are made available in FLOAT32 format so that the data can be processed more simply and with a higher resolution in modern data processing systems and controllers.

Basic type 4

Byte	Data content	Format	Unit	ETU 8-series	ETU 5-series
0 ... 3	Current in phase L ₁	FP32	A	✓	✓
4 ... 7	Current in phase L ₂	FP32	A	✓	✓
8 ... 11	Current in phase L ₃	FP32	A	✓	✓
12 ... 15	Current in phase under highest load	FP32	A	✓	✓

- ✓ Relevant for

Basic type 5

Byte	Data content	Format	Unit	ETU 8-series	ETU 5-series
0 ... 3	Current in phase L ₁	FP32	A	✓	✓
4 ... 7	Current in phase L ₂	FP32	A	✓	✓
8 ... 11	Current in phase L ₃	FP32	A	✓	✓
12 ... 15	Current in phase under highest load	FP32	A	✓	✓
16 ... 19	Current in neutral conductor	FP32	A	✓	✓
20 ... 23	Active energy import in 3 phases	FP32	kWh	✓	-

- ✓ Relevant for
- Not applicable

Basic type 6

Byte	Data content	Format	Unit	ETU 8-series	ETU 5-series
0 ... 3	Current in phase L ₁	FP32	A	✓	✓
4 ... 7	Current in phase L ₂	FP32	A	✓	✓
8 ... 11	Current in phase L ₃	FP32	A	✓	✓
12 ... 15	Maximum current in phase under highest load	FP32	A	✓	✓
16 ... 19	Current in neutral conductor	FP32	A	✓	✓
20 ... 23	Active power in 3 phases	FP32	W	✓	-
24 ... 27	Reactive power in 3 phases	FP32	var	✓	-

- ✓ Relevant for
- Not applicable

Basic type 7

Byte	Data content	Format	Unit	ETU 8-series	ETU 5-series
0 ... 3	Current in phase L ₁	FLOAT32	A	✓	✓
4 ... 7	Current in phase L ₂	FLOAT32	A	✓	✓
8 ... 11	Current in phase L ₃	FLOAT32	A	✓	✓
12 ... 15	Current in phase under highest load	FLOAT32	A	✓	✓
16 ... 19	Current in neutral conductor	FLOAT32	A	✓	–
20 ... 23	Active energy import in 3 phases	FLOAT32	kWh	✓	–
24 ... 27	Average power factor in 3 phases	FLOAT32		✓	–

- ✓ Relevant for
- Not applicable

Control bytes

The following control bytes are available for each 3VA molded case circuit breaker:

Byte	Bit	Value	Activated function of the 3VA molded case circuit breaker
0	0,1	0 ... 3	Switch the 3VA molded case circuit breaker
		0	Not defined (no action)
		1	Switch off *)
		2	Switch on *)
	3	Not defined (no action)	
	2	1	Reset: Last trip reason
	3	1	Reserved
	4	1	Reserved
1	0,1	5	Reserved
		6	Reserved
		7	Reserved
		0	Reserved
	1	Reserved	
	2	Reserved	
	3	Reserved	
	2	1	Delete tripping and event recording
3	1	Reset minimum / maximum values	
4	1	Reserved	
5	1	Reserved	
6	1	Acknowledge maintenance information	
7	1	Reserved	

*) depending on use of SEO (Stored Energy Operator)

5.9.4.2 PROFenergy

The 7KM PAC Switched Ethernet PROFINET expansion module is capable of reading out and addressing the measured variables of all 3VA molded case circuit breakers connected to the COM800 / COM100 breaker data server. The PROFenergy "Common Application Profile" from Profibus International and the "Query_Measurement" service are used for this purpose.

The currently available version of the Common Application Profile PROFenergy is version 1.1. (Technical Specification for PROFINET Version 1.1 – Date: August 2012 Order No.: 3.802).

According to this profile, measured variables can be read out with the following functions:

- IDENTIFY
- QUERY MEASUREMENT LIST
- QUERY MEASUREMENT VALUES

3VA molded case circuit breakers are addressed on the basis of the breaker address (identical to slot address). You will find more information on this in chapter PROFINET IO (Page 184).

Measurement ID	Name	Accuracy Domain	Accuracy Class	In Get List
1	voltage PH-N L1	2	12	✓
2	voltage PH-N L2	2	12	✓
3	voltage PH-N L3	2	12	✓
4	voltage PH-PH L1-L2	2	12	✓
5	voltage PH-PH L2-L3	2	12	✓
6	voltage PH-PH L3-L1	2	12	✓
7	current L1	2	12	✓
8	current L2	2	12	✓
9	current L3	2	12	✓
10	apparent power L1	2	13	
11	apparent power L2	2	13	
12	apparent power L3	2	13	
13	active power L1	2	13	
14	active power L2	2	13	
15	active power L3	2	13	
16	reactive power L1 (Qn)	2	13	
17	reactive power L2 (Qn)	2	13	
18	reactive power L3 (Qn)	2	13	
19	power factor L1	1	12	
20	power factor L2	1	12	
21	power factor L3	1	12	
22				
30	frequency	2	4	

Measurement ID	Name	Accuracy Domain	Accuracy Class	In Get List
31	average voltage PH-N	2	12	
32	average voltage PH-PH	2	12	
33	average current	2	12	
34	collective active power	2	13	
35	collective reactive power (Qn)	2	13	✓
36	collective apparent power	2	13	✓
37	collective power factor	2	13	✓
38				
40	max. voltage PH-N L1	2	12	
41	max. voltage PH-N L2	2	12	
42	max. voltage PH-N L3	2	12	
43	max. voltage PH-PH L1-L2	2	12	
44	max. voltage PH-PH L2-L3	2	12	
45	max. voltage PH-PH L3-L1	2	12	
46	max. current L1	2	12	
47	max. current L2	2	12	
48	max. current L3	2	12	
49	max. apparent power L1	2	13	
50	max. apparent power L2	2	13	
51	max. apparent power L3	2	13	
52	max. active power L1	2	13	
53	max. active power L2	2	13	
54	max. active power L3	2	13	
55	max. reactive power L1 (Qn)	2	13	
56	max. reactive power L2 (Qn)	2	13	
57	max. reactive power L3 (Qn)	2	13	
58	max. power factor L1	1	12	
59	max. power factor L2	1	12	
60	max. power factor L3	1	12	
61	max. frequency	2	4	
62	max. average voltage PH-N	2	12	
63	max. average voltage PH-PH	2	12	
64	max. average current	2	12	
65	max. collective active power	2	13	
66	max. collective reactive power (Qn)	2	13	
67	max. collective apparent power	2	13	
68	max. collective power factor	2	13	
69				
70	min. voltage PH-N L1	2	12	
71	min. voltage PH-N L2	2	12	
72	min. voltage PH-N L3	2	12	

5.9 Switched Ethernet PROFINET expansion module

Measurement ID	Name	Accuracy Domain	Accuracy Class	In Get List
73	min. voltage PH-PH L1-L2	2	12	
74	min. voltage PH-PH L2-L3	2	12	
75	min. voltage PH-PH L3-L1	2	12	
76	min. current L1	2	12	
77	min. current L2	2	12	
78	min. current L3	2	12	
79	min. apparent power L1	2	13	
80	min. apparent power L2	2	13	
81	min. apparent power L3	2	13	
82	min. active power L1	2	13	
83	min. active power L2	2	13	
84	min. active power L3	2	13	
85	min. reactive power L1 (Qn)	2	13	
86	min. reactive power L2 (Qn)	2	13	
87	min. reactive power L3 (Qn)	2	13	
88	min. power factor L1	1	12	
89	min. power factor L2	1	12	
90	min. power factor L3	1	12	
91	min. frequency	2	4	
92	min. average voltage PH-N	2	12	
93	min. average voltage PH-PH	2	12	
94	min. average current	2	12	
95	min. collective active power	2	13	
96	min. collective reactive power (Qn)	2	13	
97	min. collective apparent power	2	13	
98	min. collective power factor	2	13	
99 ... 149				
189				
190	cumulated apparent power act. period	2	13	
191	cumulated active power import act. period	2	13	
192	cumulated reactive power import act. period	2	13	
193	cumulated active power export act. period	2	13	
194	cumulated reactive power export act. period	2	13	
195	max. value active power act. period	2	13	
196	min. value active power act. period	2	13	
197	max. value reactive power act. period	2	13	
198	min. value reactive power act. period	2	13	
199				
200	active energy import (float format)	2	13	
201	active energy export (float format)	2	13	
202	reactive energy import (float format)	2	13	

Measurement ID	Name	Accuracy Domain	Accuracy Class	In Get List
203	reactive energy export (float format)	2	13	
204	apparent energy (float format)	2	13	
210	active energy import (Double format)	2	13	
211	active energy import (Double format)	2	13	
212	reactive energy import (Double format)	2	13	
213	reactive energy export (Double format)	2	13	
214	apparent energy (Double format)	2	13	

See also

Addressing in the COM800 / COM100 breaker data server (Page 205)

5.9.4.3 Acyclic communication via PROFINET

Control of the individual 3VA molded case circuit breakers via DS93 and PROFINET as well as PROFIBUS is possible using acyclic communication. You can find more information in chapter Acyclic communication via PROFIBUS DP (Page 170).

Access to all the measured variables and information listed in chapter Functions (Page 41) with Read data record (DS47) and Write data record (DS48) is also possible via PROFINET.

You can find the protocol sequence for Read data record and Write data record in the Manual "7KM PAC PROFIBUS DP, 7KM PAC SWITCHED ETHERNET Expansion modules". In addition, libraries are available for SIMATIC S7 and SIMATIC PCS7 that make data available in the SIMATIC.

5.9.4.4 Modbus TCP with the Switched Ethernet PROFINET expansion module

Communication with Modbus TCP is also available via the Switched Ethernet PROFINET expansion module - see chapter Addressing via Modbus TCP (Page 206) for details.

External Ethernet switches and / or long Ethernet cables can thus be also avoided for Modbus TCP communication.

5.10 RS 485 expansion module

5.10.1 Connection

5.10.1.1 Connection of 24 V supply

The 7KM PAC RS 485 expansion module is supplied with all its power by the COM800 / COM100 breaker data server.

5.10.1.2 Connection of the 7KM PAC RS 485 expansion module

Required tools

To install the cables at the screw terminals, you will require:

- Cross-tip screwdriver PZ1, 0.5 Nm / 4.5 lb-in cal. ISO 6789

If you use cables with wire end ferrules, you also require:

- Crimping tool in accordance with EN 60947-1

NOTICE

Voltage potential can damage communication module.

- To avoid damage from active voltage, the system must be de-energized before installing the 7KM PAC RS 485 expansion module.
- To avoid damage from the buildup of static charge, ensure there is no static buildup before touching the system components.

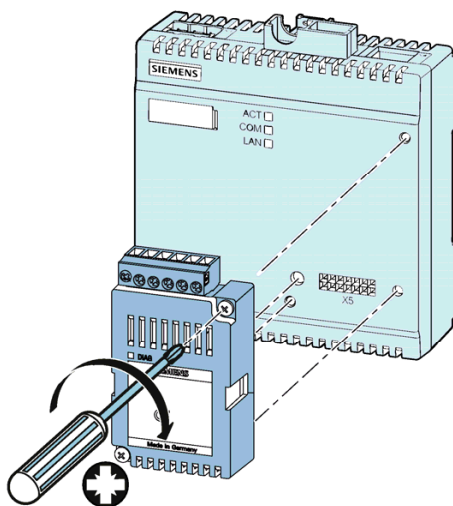

1. Handle the 7KM PAC RS 485 expansion module by its plastic housing only.
2. Attach the 7KM PAC RS 485 expansion module to the COM800 / COM100 breaker data server. The guide pins will ensure that the 7KM PAC RS 485 expansion module is plugged in correctly.
3. Tighten the screws connecting the 7KM PAC RS 485 expansion module to the COM800 / COM100 breaker data server with a torque of 0.5 Nm / 4.5 lb-in.

Procedure for connecting to Modbus RTU

Connect the 7KM PAC RS 485 expansion module to Modbus RTU. Please pay attention to the general topology of the twisted-pair cable.

1. Connect the Com, +/B and -/A cables to the appropriate screw terminals on the terminal block. You can find the assignments of the terminals in the figure below.
2. Connect the cable shield with protective ground at one end using a grounding contact.

- On the first and last communication nodes, switch a bus terminating resistor between the positive signal and the negative signal. A 120-Ohm bus terminating resistor is implemented in the 7KM PAC RS 485 expansion module for this purpose. Activate the internal terminating resistor with a jumper between terminals -/A and Ter.

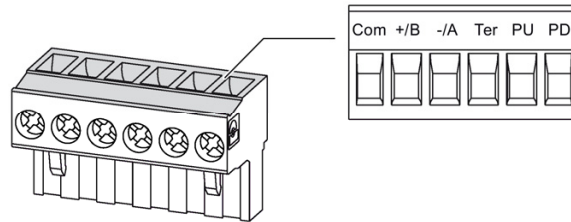

+/B B signal
 -/A A signal
 Com Common
 Ter (Line) Termination = Bus terminating resistor
 PU pull-up resistor
 PD pull-down resistor

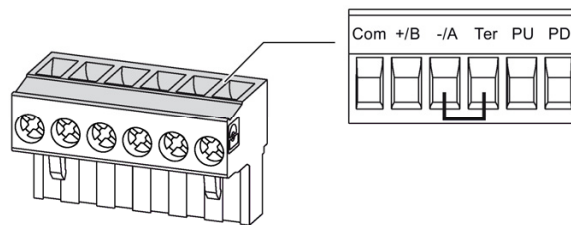

NOTICE

Communication errors

Terminating resistors are required for proper communication bus functionality.

Never attach more than two bus terminating resistors to one bus. Attach one bus terminating resistor at the start of the bus, and one at the end of the bus.

- Make sure that there is sufficient strain relief for the connected cables.

Line polarization

A resistor for line polarization is implemented in the 7KM PAC RS 485 expansion module.

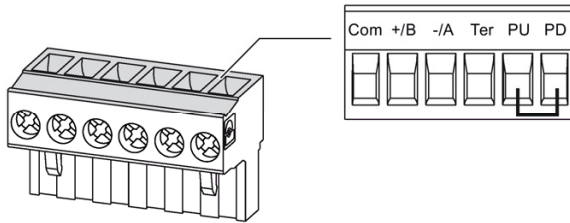

If one or more communication nodes require line polarization/biasing, switch the PU and PD resistor by installing a jumper between terminals PU and PD on the terminal block of the relevant 7KM PAC RS 485 expansion module.

Note

Note - only one device on the bus is allowed to provide polarization/biasing.

Block diagram

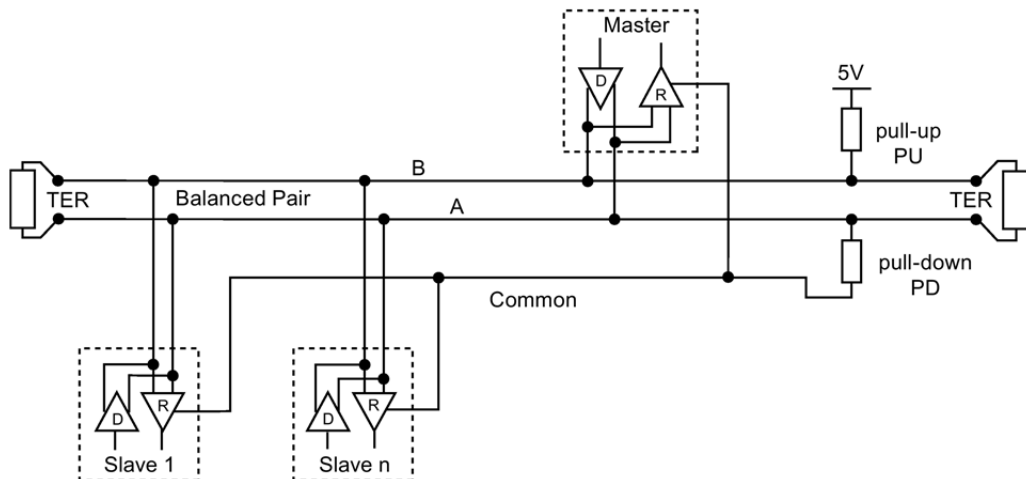

- TER Bus terminating resistor (Termination)
- PU Pull-up resistor
- PD Pull-down resistor

Grounding of the cable shield

The serial Modbus data cable should be shielded. The shield should be connected to protective ground at one end of the cable at least.

Grounding of the common cable

Many masters do not have a common terminal. If this is the case, then RS485 common should reference the same functional ground as the master (at a single point). If the master has a common terminal, then the common is connected to it, and it is not connected to functional ground.

References

You can find further information at www.modbus.org (<http://www.modbus.org>) in the following specification:

MODBUS over Serial Line (http://modbus.org/docs/Modbus_over_serial_line_V1_02.pdf)

5.10.2 Commissioning

5.10.2.1 First commissioning

The 7KM PAC RS 485 expansion module is supplied from the factory with the following defaults:

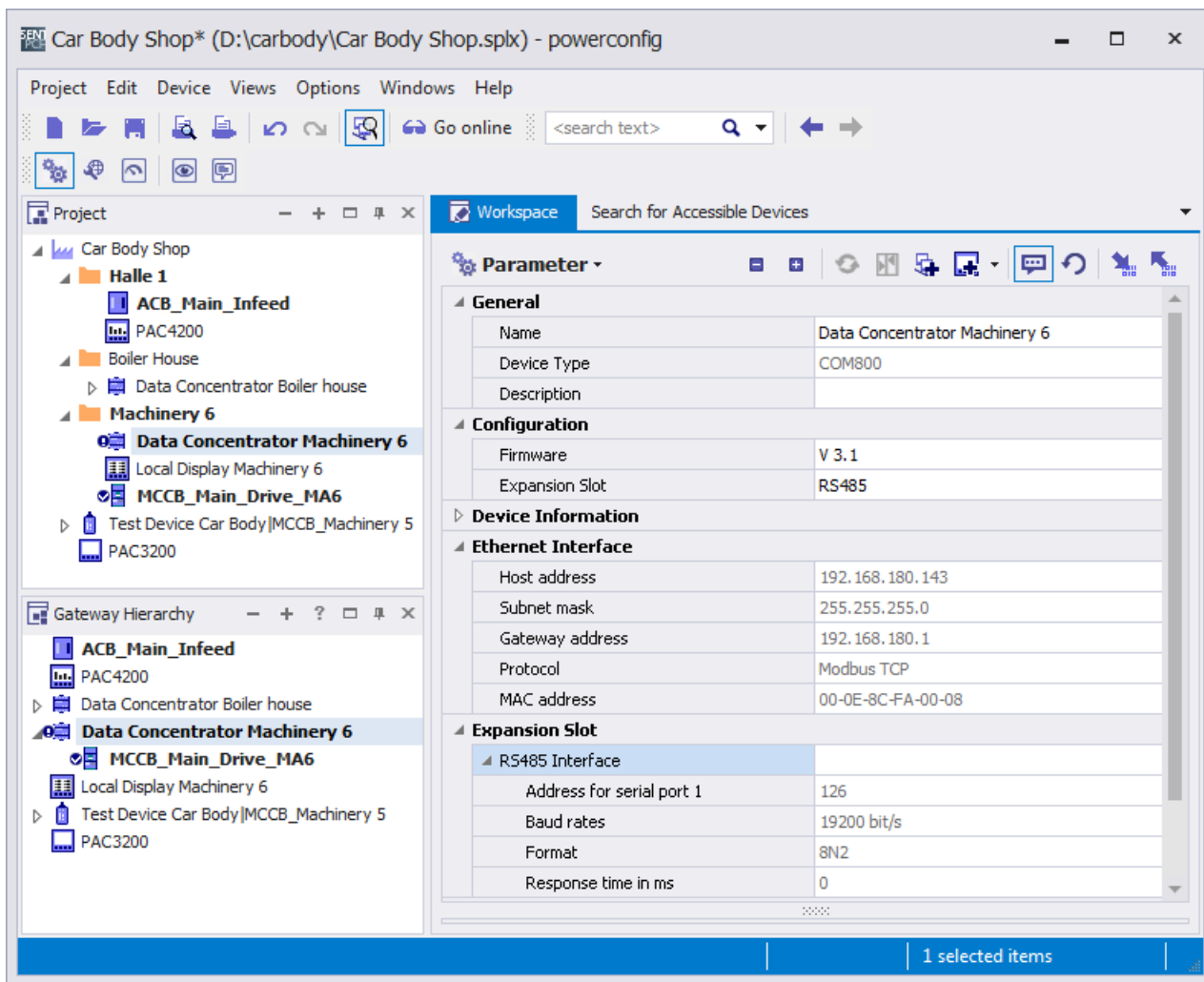

With this setting, the 3VA molded case circuit breaker can be accessed from a Modbus master, e.g. via PAC4200 as the gateway, for powerconfig.

NOTICE

Abnormal communication bus behavior with identical addresses

Several RS 485 nodes with the same address can cause abnormal behavior of the entire serial RS 485 bus. The master can then not communicate with the slave devices connected to the RS 485 bus.

Assign a unique address to every RS 485 node step-by-step.

5.10.2.2 Resetting

Resetting is accomplished by assigning a new Modbus RTU address.

Either the address of the expansion module must be reset to 126 or the address to be set must be known.

5.10.2.3 Commissioning

Commissioning of the RS 485 interface must always take place in conjunction with the Modbus master (in this case, the PAC4200). It is important that the RS 485 parameters are identical, and the addresses are different. If PAC4200 is used as the Modbus gateway (in other words, as the Modbus master), powerconfig checks this setting.

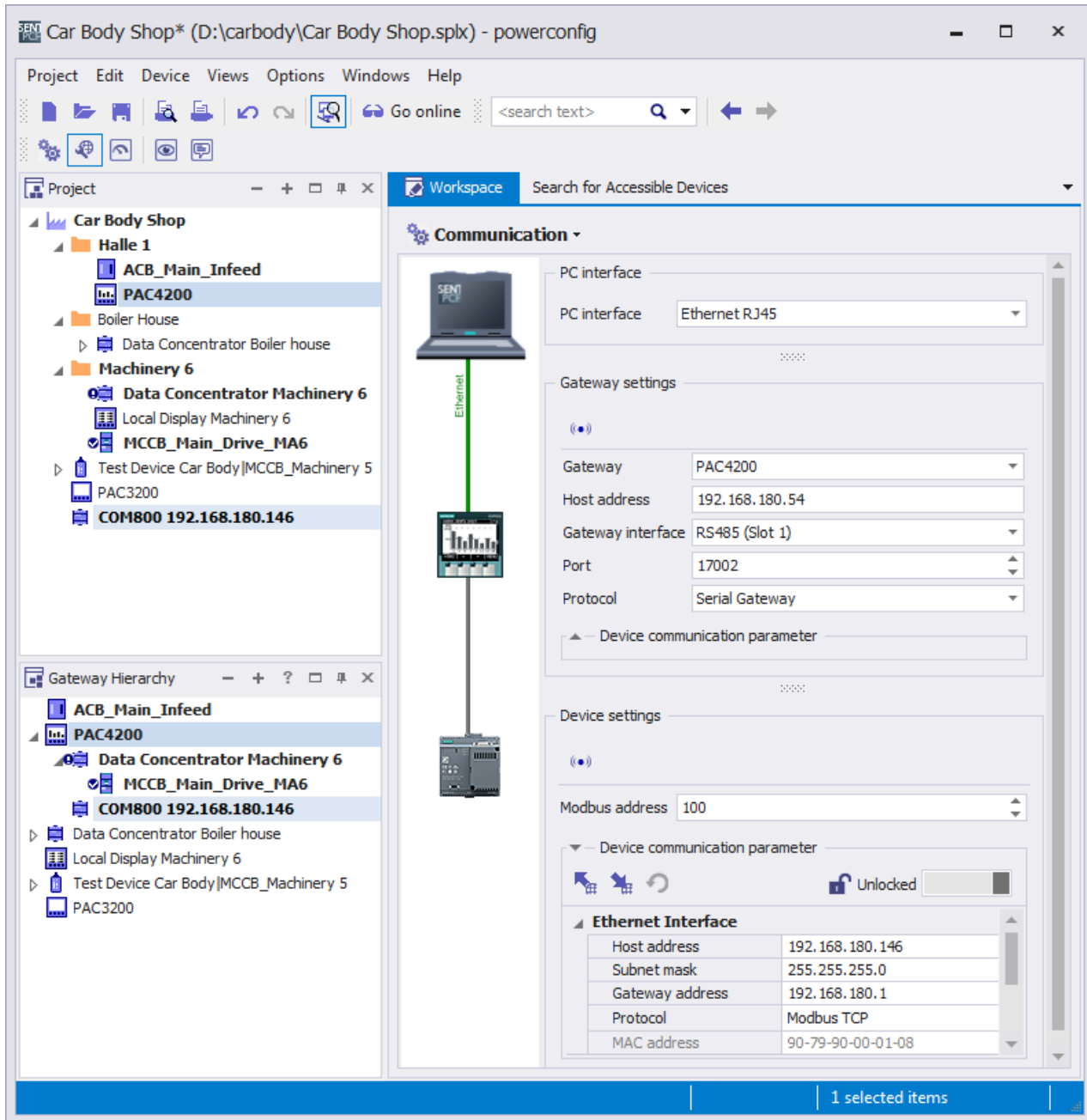

If another Modbus master is used, the user must ensure consistency.

Furthermore, the Modbus master must observe the addressing and protocols described in chapter Addressing via Modbus (Page 205).

5.10.3 Operation

Configuration scenario

With the 7KM PAC RS 485 expansion module, the 3VA molded case circuit breaker can communicate via a COM800 / COM100 breaker data server and Modbus RTU with powermanager and powerconfig.

The 7KM PAC RS 485 expansion module can also be used to connect the 3VA molded case circuit breaker with a system from another vendor.

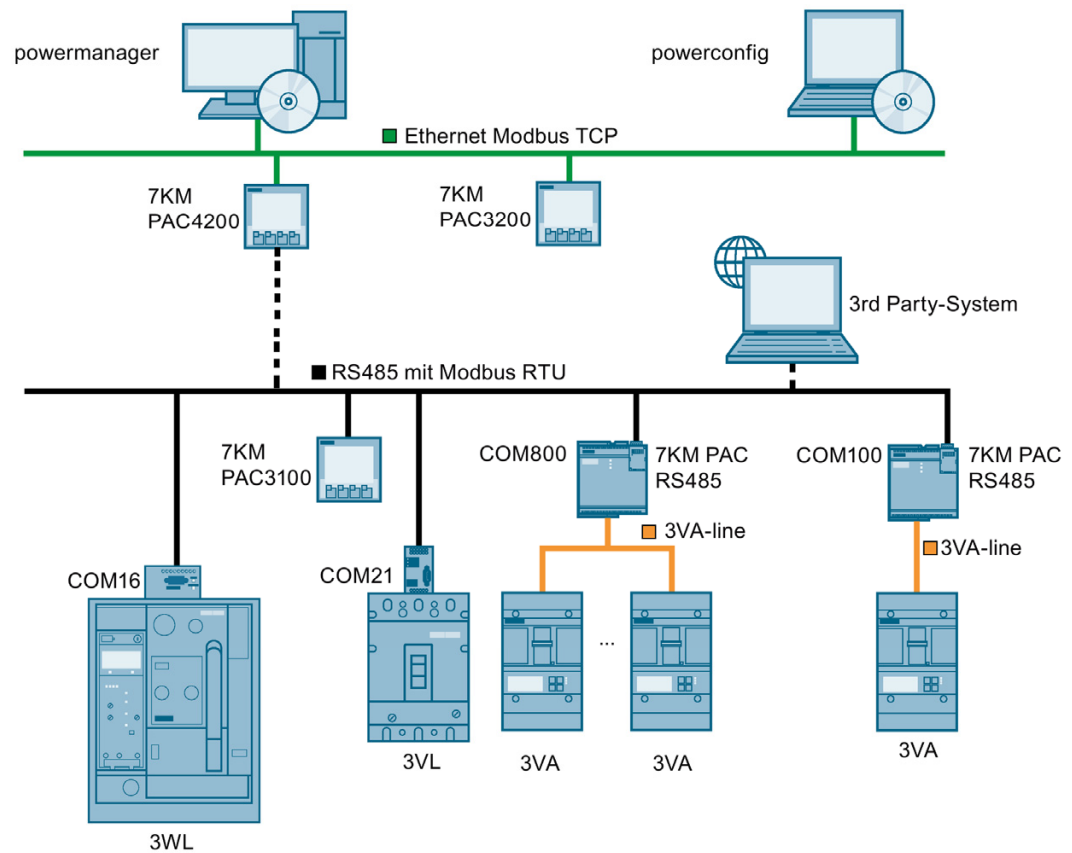

The Functions (Page 41) described in Chapter 3 are available via the RS 485 interface of the 7KM PAC RS 485 expansion module. The database described in chapter Available database (Page 73) is available.

Addressing via Modbus

6.1 Addressing in the COM800 / COM100 breaker data server

The COM800 breaker data server supports eight simultaneously communicating 3VA molded case circuit breakers, and the COM100 breaker data server supports only one communicating 3VA molded case circuit breaker.

The 3VA molded case circuit breakers are addressed for communication via the breaker addresses. The breaker address is used in the same context as the communication interface:

- PROFIBUS: See chapter PROFIBUS DP expansion module (Page 155)
- PROFINET: See chapter Switched Ethernet PROFINET expansion module (Page 177)
- Modbus TCP: See chapter Addressing via Modbus TCP (Page 206)
- Modbus RTU: See chapter Addressing via Modbus RTU (Page 208)

As soon as a breaker configuration is created for a COM800 / COM100 breaker data server (see chapter Commissioning a 3VA connected to COM800 / COM100 (Page 119)), this configuration is saved in the COM800 / COM100 breaker data server. The configuration is even available when the 3VA molded case circuit breaker is temporarily not available. In this case, the configuration is passive. The configuration is active as soon as the 3VA molded case circuit breaker is re-connected with the COM800 / COM100 breaker data server.

Every COM800 / COM100 breaker data server supports the same number of actively and passively communicating 3VA molded case circuit breakers.

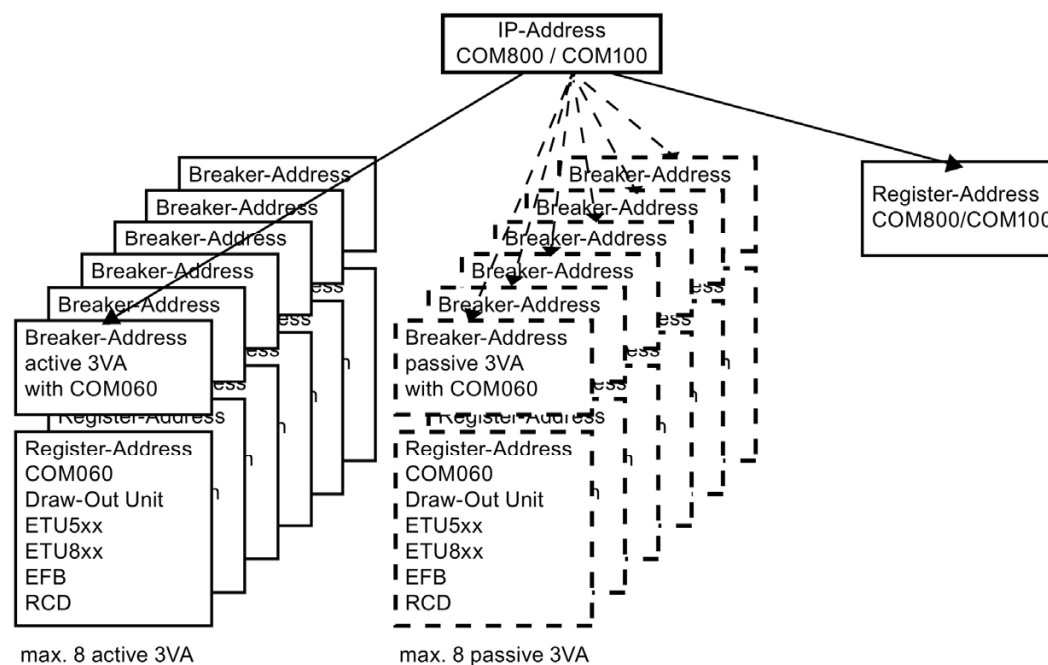

The breaker address is used as a sub-address within the COM800 / COM100 breaker data server.

Read operations are conducted using FC 0x03 (function codes).

The register addresses for data points in individual components are described in chapter Available database (Page 73).

6.2 Communication via Modbus

6.2.1 Addressing via Modbus TCP

The COM800 / COM 100 breaker data servers can be operated directly on Modbus TCP. For more information, see chapter COM800 / COM100 breaker data server (Page 107).

For operation on Modbus TCP, a network or IP addresses must be assigned to the COM800 / COM100 breaker data servers. The 3VA molded case circuit breakers are addressed via the sub-addressing of the Modbus TCP protocol.

The database of the COM800 / COM100 breaker data servers (register addresses) - see chapter Available database (Page 73) - is addressed directly.

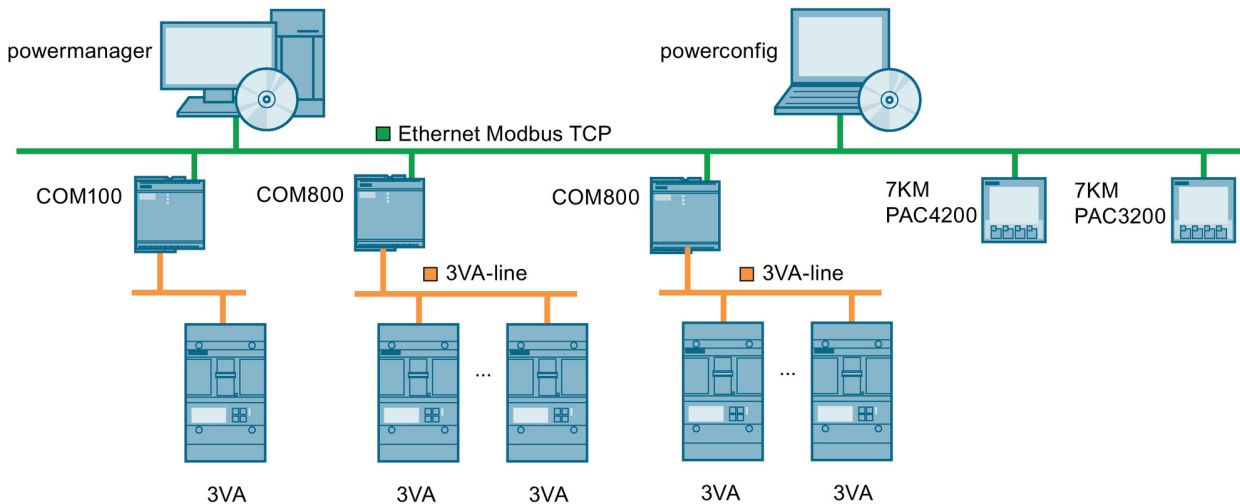

Device	COM100	3VA [A]	COM800	3VA [B]	...	3VA [J]	COM800	3VA [J]	...	3VA [Q]	PAC4200	PAC3200
IP-Address e. g.	192.168.002.001	-	192.168.002.002	-		-	192.168.002.003	-		-	192.168.002.004	192.168.002.005
Unit-Identifier	F7	1	F7	1		8	F7	1		8	F7	-

The figure shows an example of address assignment.

The breaker addresses in the individual COM800 / COM100 devices can be independent of each other.

The Unit Identifier, e.g. breaker addresses, are transferred in the field "Unit ID". For breaker addresses the range from 1 to 126 (x07E Hex) is permissible.

With address 247 (x0F7 Hex) COM800/COM100, i.e. the Modbus TCP node itself is addressed, **in this case COM800/COM100**.

Modbus Protocol Header (7 Bytes)				Protocol Data Unit (PDU)	
Transactions Identifier	Protocol Identifier	Lenghtfield	Unit Identifier	Function Code	Data
(2 Bytes)	(2 Bytes)	(2 Bytes)	(1 Byte)	(1 Byte)	(varies)

Modbus TCP/IP Application Data (ADU)
(This information is embedded into the data portion of the TCP frame)

The breaker address must be represented in the unit ID in the Modbus TCP protocol.

You can find more information on this in "Messaging on TCP/IP Implementation Guide V1.0b" and in "MODBUS APPLICATION PROTOCOL SPECIFICATION V1.1b".

Read operations are conducted using FC 0x03 (function codes).

6.2.2 Establishing a connection for Modbus TCP

The integrated Ethernet interface of the COM800 / COM100 breaker data servers is also used to update the firmware of the COM800 / COM100 and C060.

In order to avoid any conflicts between the general Modbus TCP communication and the firmware update the COMx00 status / diagnosis (0x00CB: bit 29) "Update mode" should be checked first every time a connection is established for Modbus TCP.

If the bootloader is active (update mode = 1) the connection shall be established. A wait time of at least 60 seconds is required before a connection is established again. If this rule is not observed the firmware update can be blocked by the general Modbus TCP communication. Another option is to interrupt the general Modbus TCP communication during the firmware update.

6.3 Addressing via Modbus RTU

The COM800 / COM100 breaker data servers and the connected 3VA molded case circuit breakers can be connected to Modbus RTU via the 7KM PAC RS 485 expansion module. See chapter COM800 / COM100 breaker data server (Page 107).

With Modbus RTU, both the 3VA molded case circuit breakers and the COM800 / COM100 breaker data servers are mapped to the Modbus RTU addresses.

In other words, every component is assigned a unique Modbus RTU address. Address assignment must thus take place across all COM800 / COM100 devices, 3VA molded case circuit breakers, and other devices operated on Modbus RTU.

Access to the database - see chapter Available database (Page 73) - of the COM800 / COM100 breaker data servers and the 3VA molded case circuit breakers takes place via the Modbus RTU address.

The graphic below shows an example of address assignment. The breaker address (= Modbus RTU address) must be assigned uniquely across all COM800 / COM100 devices.

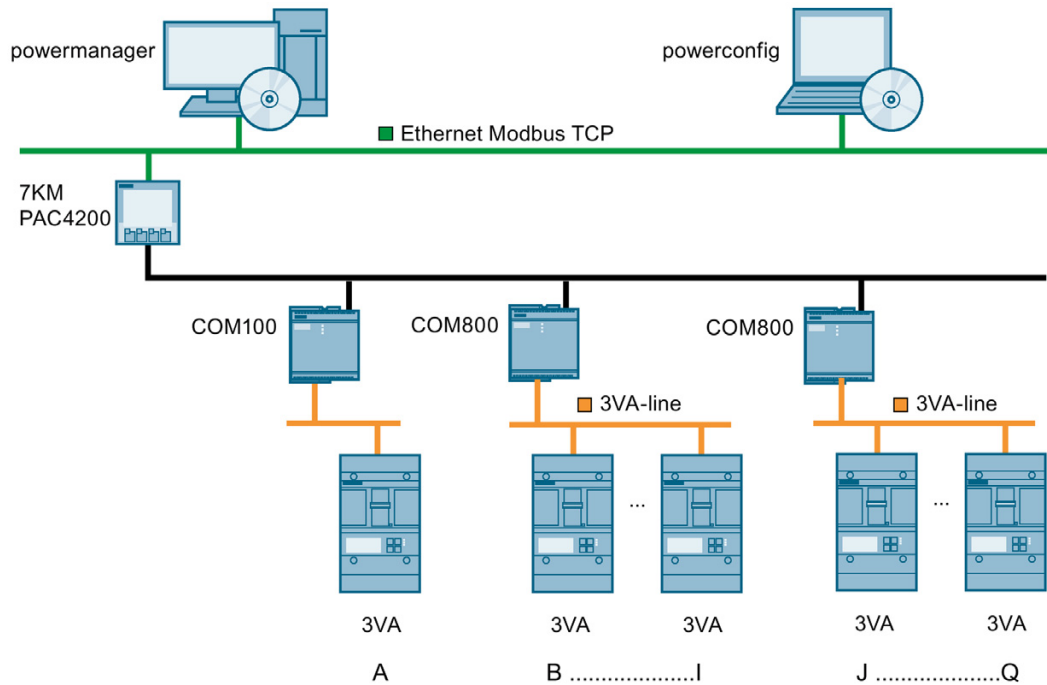

Device	PAC4200	COM100	3VA [A]	COM800	3VA [B]	...	3VA [I]	COM800	3VA [J]	...	3VA [Q]
IP-Address e. g.	192.168.002.001	-	-	-	-		-	-	-		-
Modbus RTU Address e.g.	1	2	3	4	5		12	13	14		21
Unit Identifier	-	-	3	-	5		12	-	14		21

If a Modbus gateway is used for communication, the 3VA molded case circuit breakers must be addressed with Modbus TCP from the perspective of a Modbus TCP master, e.g. powermanager.

Modbus Protocol Header (7 Bytes)				Protocol Data Unit (PDU)	
Transactions Identifier	Protocol Identifier	Lengthfield	Unit Identifier	Function Code	Data
(2 Bytes)	(2 Bytes)	(2 Bytes)	(1 Byte)	(1 Byte)	(varies)

Modbus TCP/IP Application Data (ADU)

(This information is embedded into the data portion of the TCP frame)

All Modbus RTU addresses (3VA, COM100, COM800) must be represented in the unit ID in the Modbus TCP protocol. You can find more information in "Messaging on TCP/IP Implementation Guide V1.0b" and in "MODBUS APPLICATION PROTOCOL SPECIFICATION V1.1b".

The RS 485 interface Modbus RTU is used in accordance with the specification: "MODBUS over Serial Line Specification and Implementation Guide V1.02"

Read operations are conducted using FC 0x03 (function codes).

See also

RS 485 expansion module (Page 195)

Commissioning and service software: powerconfig

7.1 Description

powerconfig is a commissioning and service software application for communication-capable measuring devices and circuit breakers from the SENTRON product family. Its main functions are as follows:

- powerconfig facilitates parameterization of the devices, resulting in considerable time savings, particularly when several devices have to be set up.
- With powerconfig, the 3VA, 3WL, 3VL circuit breakers and the 7KM PAC3100 / 3200 / 4200 and ATC5300 measuring devices can be parameterized, documented, operated and analyzed using various communication interfaces.
- The functional capability of 3VA molded case circuit breakers can be tested, documented, and archived with powerconfig and the TD500 test device.
- powerconfig can be used to archive settings electronically and as printouts.

The screenshot displays the powerconfig software interface with multiple windows. The main window shows a project hierarchy for 'Car Body Shop' with folders like 'Boiler House', 'Machinery 6', and 'Halle 1'. A 'Workspace' window is open, showing an 'Overview' for a selected circuit breaker. The overview includes a diagram of the breaker's current status and a table of electrical parameters.

Overview

The circuit breaker is closed. At the moment there are neither tripping nor warning or setpoint messages present.

Plant Identifier	Rack 3
Location Identifier	Breaker 5
Current L1	35.0 A
Current L2	30.0 A
Current L3	30.0 A
Current N	10.0 A
Current G	0.0 A
System time	15/01/2016 10:0...

Last Warning Message: No messages available
 Last Trip Message: The 3VA tripped because of an instantaneous short-circuit...

Online | 1 selected items

7.1 Description

7.1.1 Delivery

powerconfig (<http://www.siemens.com/lvmobile/powerconfig>) can be downloaded from Industry Online Support.

7.1.2 System requirements

The latest version of powerconfig should always be used. You can find the latest version of powerconfig (<http://www.siemens.com/lvmobile/powerconfig>) at Industry Online Support.

Use of powerconfig requires one of the following system environments:

Hardware

- CPU Intel Pentium IV, 3GHz
- 2GB RAM
- Available hard disk space 500 MB
- Color monitor with a minimum resolution of 1024 x 768 pixels.

Software

- Operating system
 - Microsoft Windows 7 Professional SP1 (32-bit / 64-bit)
 - Microsoft Windows 7 Ultimate SP1 (32-bit / 64-bit)
 - Microsoft Windows 8.1 Professional (64-bit)
 - Microsoft Windows 8.1 Enterprise (64-bit)
 - Microsoft Windows Server 2008 (64-bit)
 - Microsoft Windows Server 2012 (64-bit)
 - Microsoft Windows 10
 - Framework Microsoft .NET V4.0

powerconfig can also be used in conjunction with

- STEP 7, V5.5 SP1 or higher (optional)
- STEP 7 V13 (TIA Portal)
- PG/PC PROFIBUS interface (optional)

The system requirements may change. They are described in the Readme file for the relevant version and can be checked at Industry Online Support (<http://support.automation.siemens.com/WW/view/de/22951684/133100>).

7.1.3 PC network settings

Settings for the search for accessible devices

The communication settings for the search must be entered in the view "Search for Accessible Devices" (icon .

To perform the search via Ethernet, it is necessary to select the network adapter on the PC via which the devices can be accessed. Furthermore, the following ports (incoming and outgoing) must be enabled for the UDP protocol:

- 17009
- 17008

See below: Setting firewall rules

To perform a serial search, the COM ports of the PC which are to be searched must be selected.

Settings for operation (online view) of devices

To allow the detected devices to be operated via Ethernet, data exchange with the Ethernet interface of the PC using version 4 of the Internet protocol (TCP/IPv4) must be set up. In Windows 7 the properties of interfaces are configured in menus "Control Panel\Network and Internet\Network and Sharing Center".

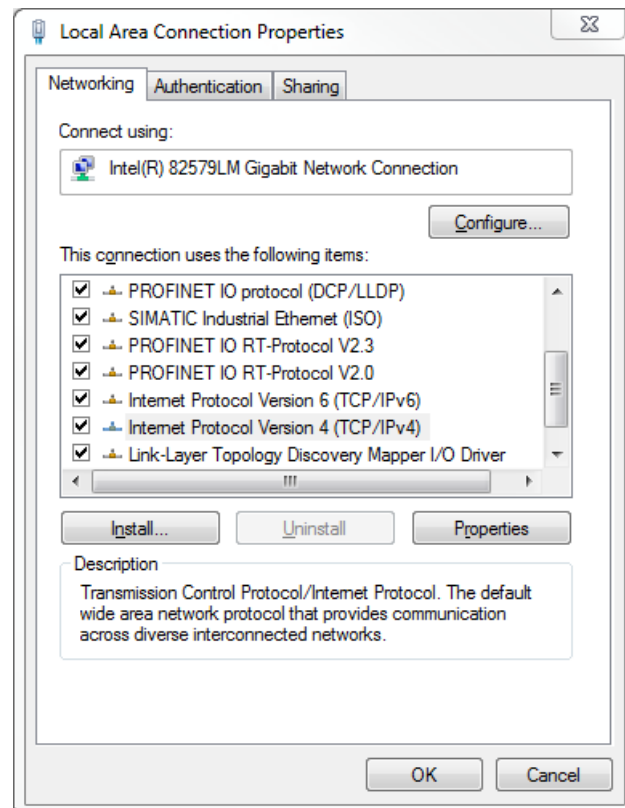

7.1 Description

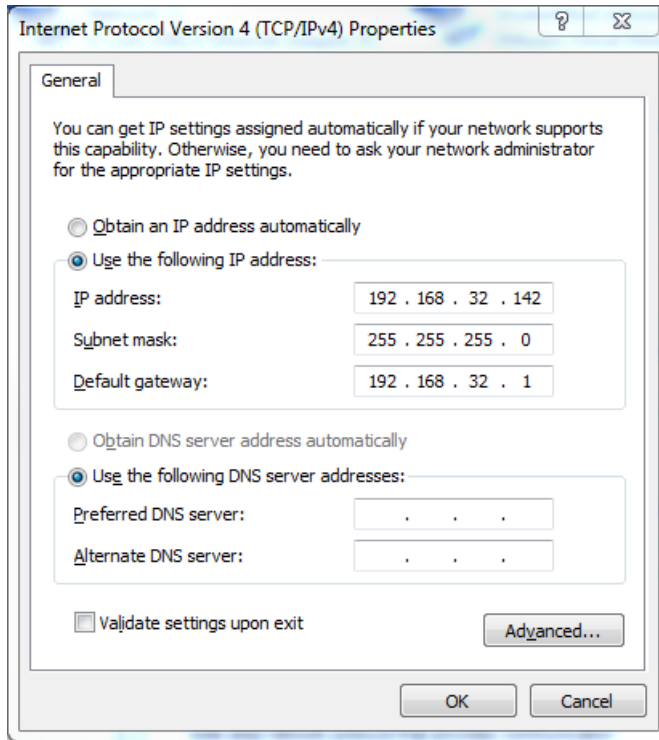

The settings for the IP address and subnet mask must be entered in accordance with the rules for assigning network IP addresses in a PC and the devices.

It is also important to ensure that the following ports are enabled for the TCP protocol:

- 502 (communication via Modbus TCP)
- 17001 (communication via SEABUS)
- 17002 (only PAC4200 for gateway function with expansion slot 1)
- 17003 (only PAC4200 for gateway function with expansion slot 2)

The following UDP port (incoming) must be enabled for firmware update:

- 69 Required only for PAC3200 firmware update via powerconfig

Setting firewall rules

Firewall rules are set as follows in Windows 7:

Control Panel\All Control Panel Items\Windows Firewall\Advanced Settings.

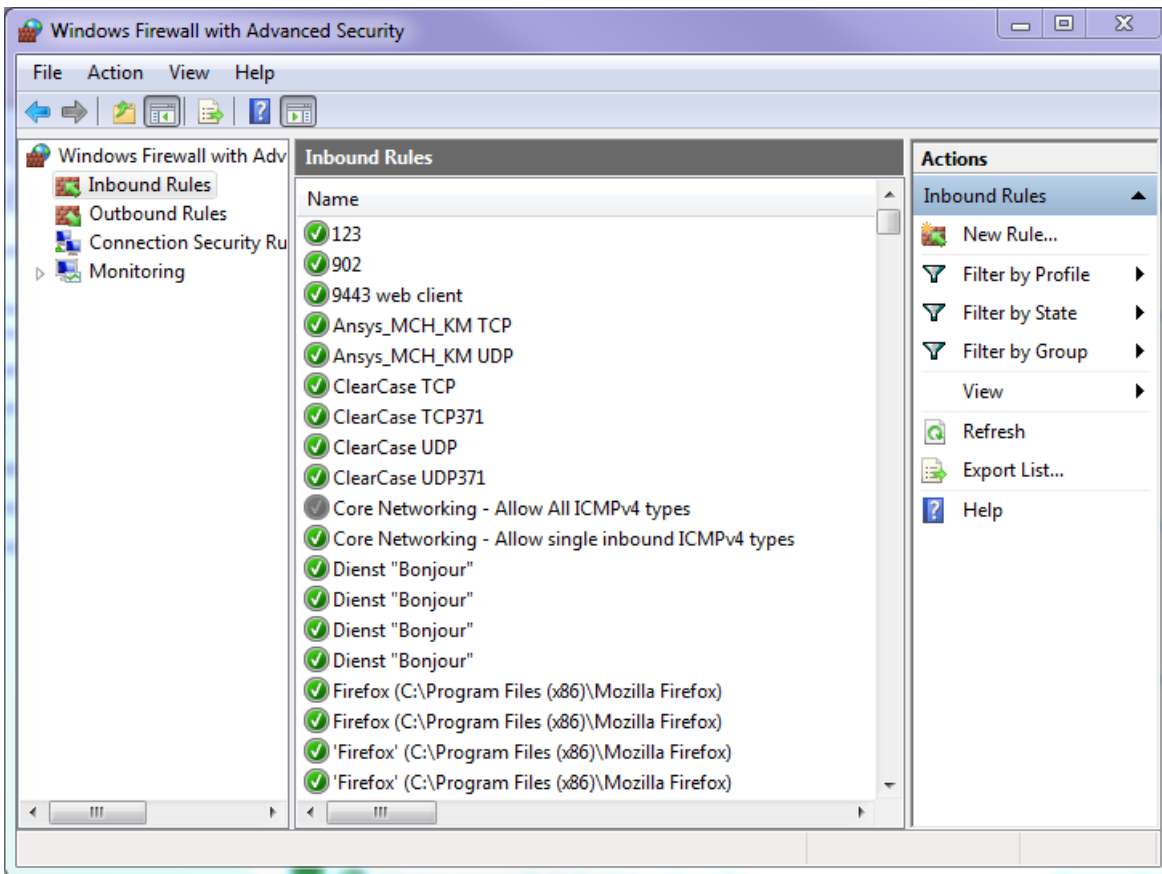

7.1 Description

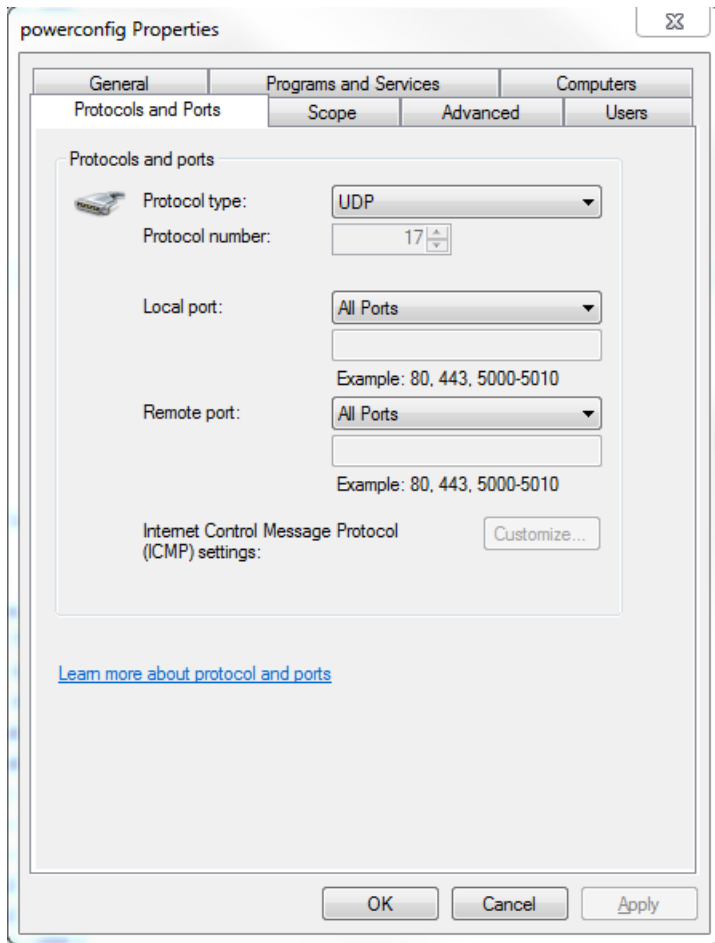

7.2 User interface

The user interface of powerconfig is clearly structured to meet specific user requirements. It consists of the familiar standard Windows functions and system-specific operator control elements.

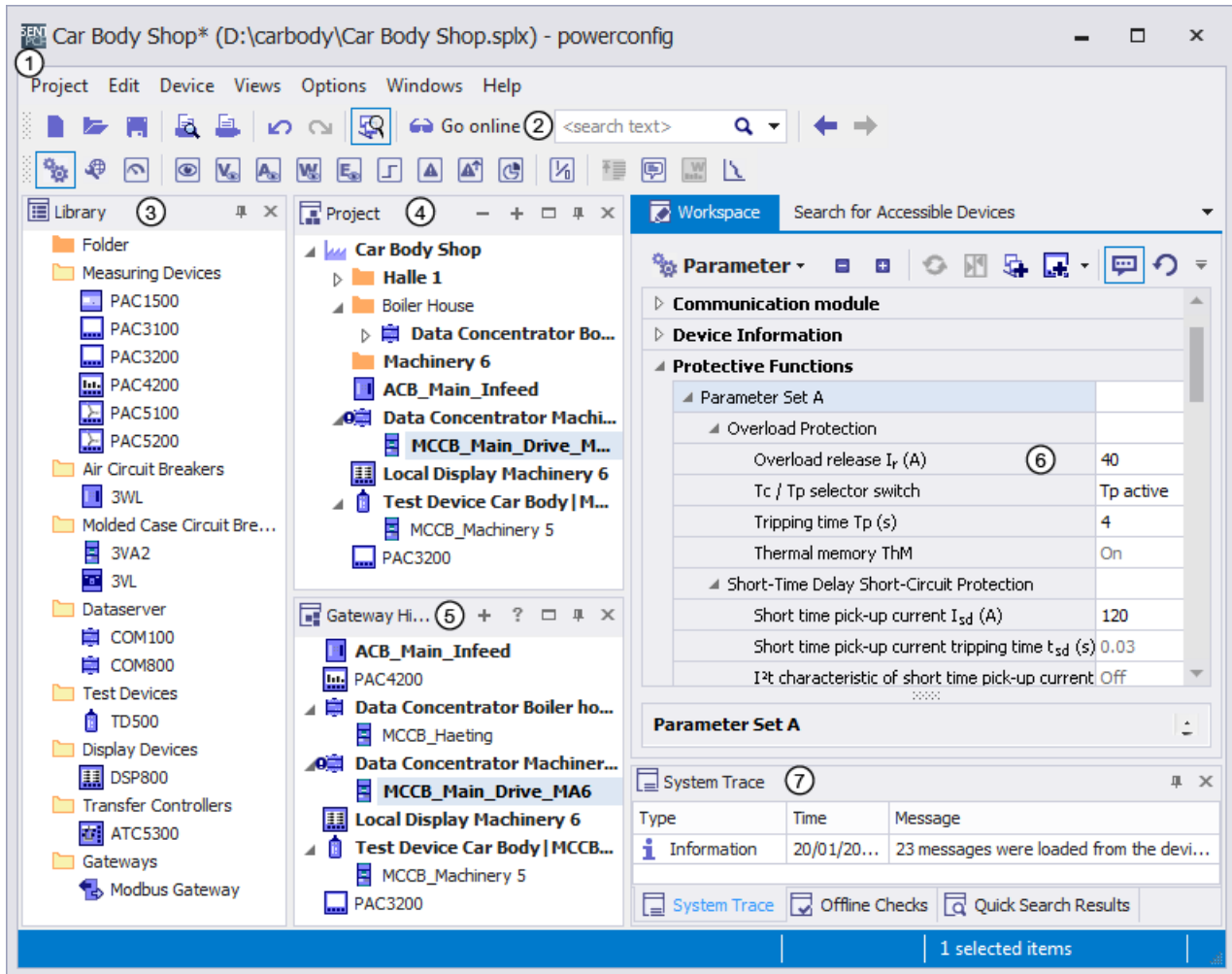

① Application frame

The application frame includes powerconfig with various windows. Windows can be shown or hidden to suit individual requirements.

Note:

Settings which have not yet been stored are signaled by a "*" at the end of the project name in the title bar. Changes should be stored from time to time.

② Toolbar

In addition to functions like "Create New Project" or "Open Project" that are normally available in Windows, the toolbar also contains powerconfig-specific icons such as "Search for Accessible Devices", "Activate Online View" and "Search in Project".

③ Library

The library contains the SENTRON devices supported by powerconfig as well as a folder as a structure element. The user can create a project from these elements.

④ **Project**

The project represents the layout of equipment in an installation and acts as an orientation guide to the powerconfig user. Examples of an equipment layout are "Buildings" – "Main distribution systems" – "Subdistribution boards" etc. or production areas. The project can be created from the library in offline mode. Alternatively, devices can be detected by the "Search for Accessible Devices" function and inserted into the project. It is also possible to insert 3VA molded case circuit breakers detected via the COM800 / COM100 into the project.

⑤ **Gateway hierarchy**

The gateway hierarchy determines the communication structure in the installation. Devices that can be accessed directly from powerconfig are on the highest (left-hand) level. Devices that are accessible via a gateway are on the right-hand levels.

Typical gateways are:

- PAC4200 for devices with RS 485 (Modbus RTU) such as, for example, PAC3100 or 3WL with COM16 or
- COM800 / COM100 for 3VA molded case circuit breakers or
- TD500 for 3VA molded case circuit breakers.

⑥ **Working area**

The working area shows the views and editing options for the device selected in the project.

- Device properties are displayed and set in the "Parameters" view. These include, for example, the protection parameters for 3VA molded case circuit breakers.
- The complete access path, including the address, is set or displayed in the "Communication" view.
- The "Overview" view shows the primary functions of the device.
- The "Measuring Values" view shows a detailed summary of the variables currently measured at the device.

In addition to these, there are also further views which reflect the functional scope of the relevant devices. e.g. currents, energy meters, or messages stored in the device.

⑦ **Protocol**

- The system protocol shows all the essential procedures during the powerconfig session
- The offline checks list violations of configuring rules
- The result of the quick search shows all the devices found by the Search function

7.3 Application types

The working sequence recommended for powerconfig is depicted below:

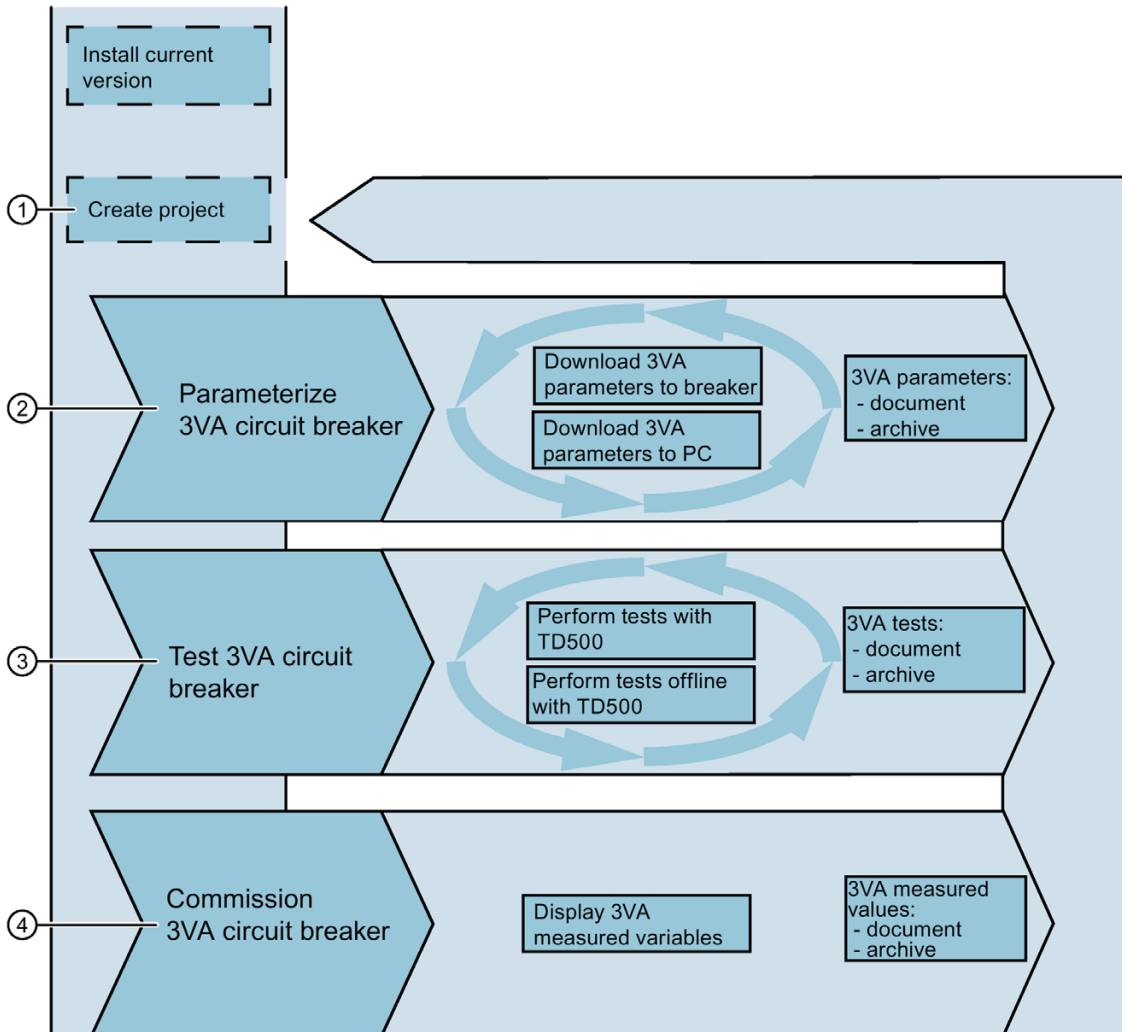

- ① Project management (Page 220)
- ② Parameterizing 3VA molded case circuit breakers (Page 222)
- ③ Testing 3VA molded case circuit breakers (Page 223)
- ④ Commissioning of 3VA molded case circuit breakers (Page 224)

7.3.1 Project management

3VA molded case circuit breakers and, in some cases, other devices supported by powerconfig are combined in powerconfig to form a project if they are related to one another from a technical, organizational or some other perspective.

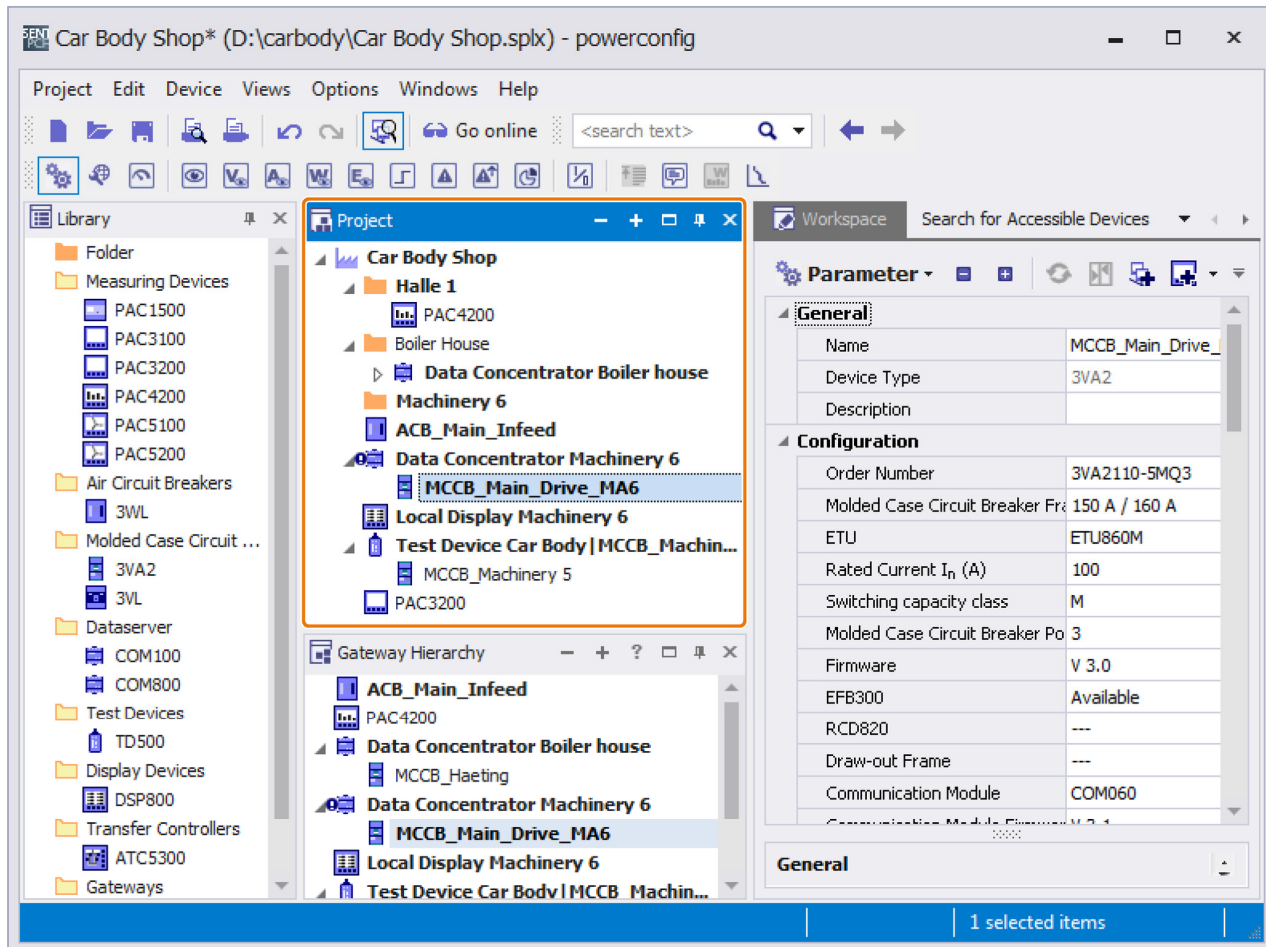

Devices are arranged in the gateway hierarchy according to their communication hierarchy.

A 3VA molded case circuit breaker can be inserted into a project by a variety of different methods:

- Copy the SENTRON device from the library to the project.
- Search for a SENTRON device, such as a COM800 / COM100 breaker data server, online and "add" it to the project.

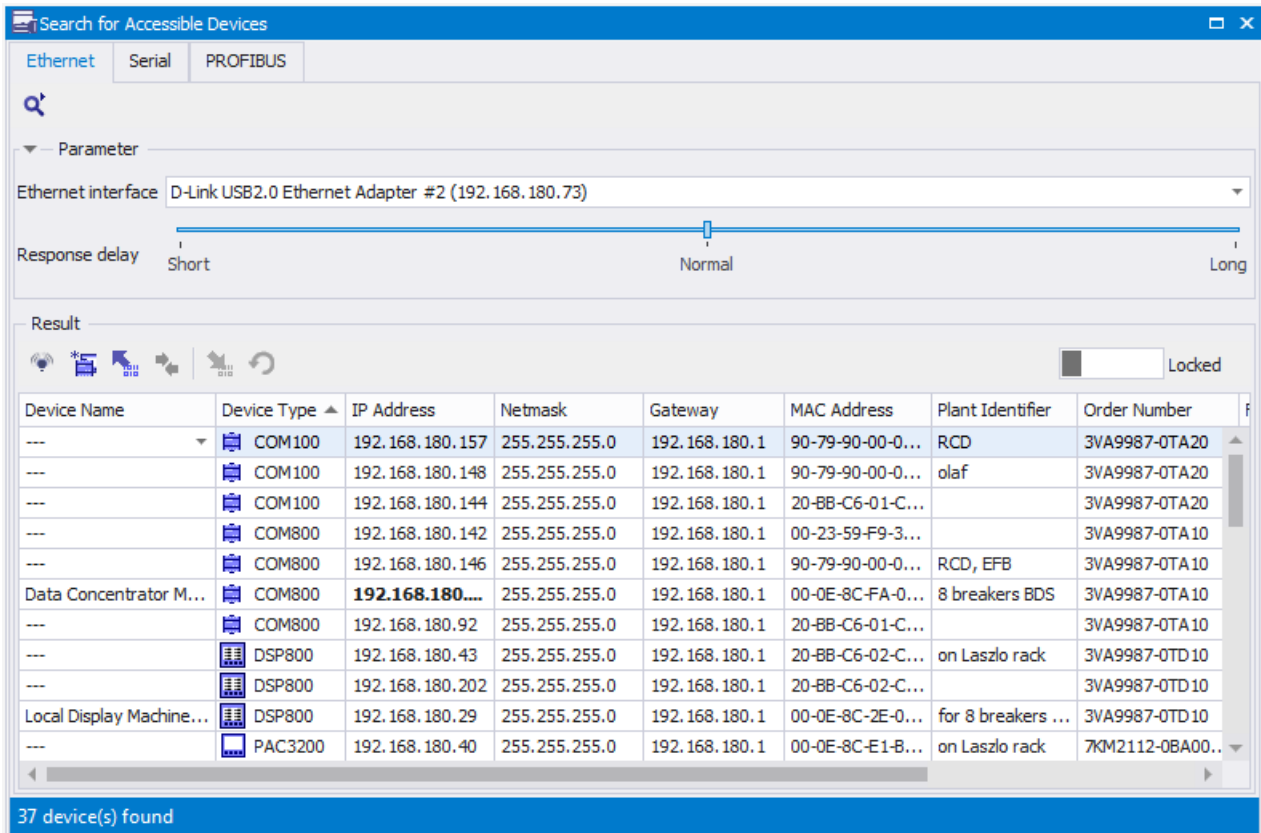



- Insert a SENTRON device from a different project into the current project.
- Import SENTRON devices from SIMARIS design

7.3.2 Parameterizing 3VA molded case circuit breakers

If a project has been created and possibly contains existing devices, the devices can be optimally adapted via parameterization to perform a specific function in the installation.

3VA molded case circuit breakers can be parameterized with powerconfig by two different methods:

- Configure the 3VA molded case circuit breaker in the project in offline mode and then download parameters to the device using the icon 
- Use icon  to download existing 3VA molded case circuit breakers to the PC and continue editing them. Any changes to parameter settings can be downloaded to the 3VA molded case circuit breaker again

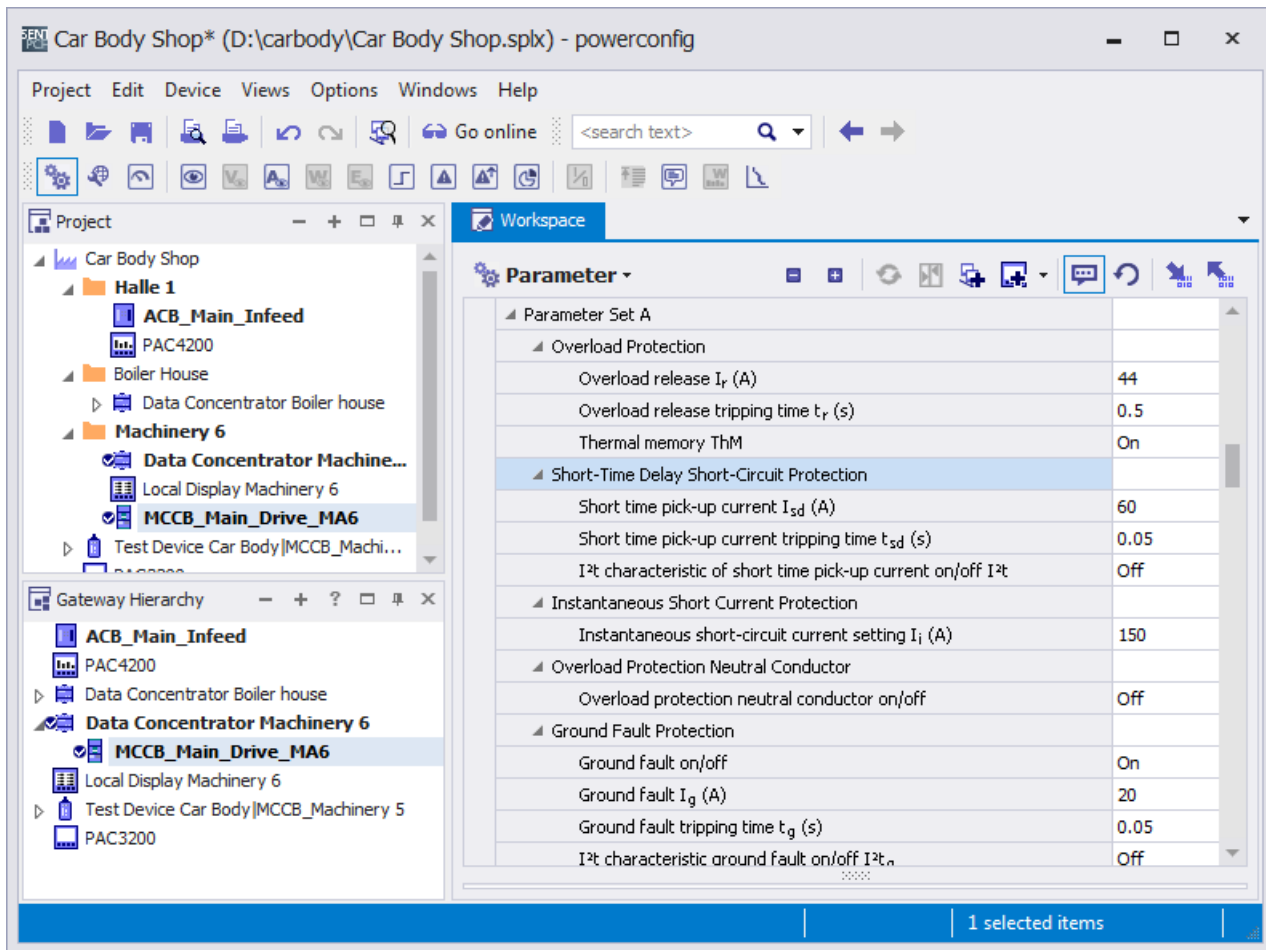

7.3.3 Testing 3VA molded case circuit breakers

If the devices have been parameterized (and already installed in some cases), it is advisable to disconnect the 3VA molded case circuit breakers from the power supply for testing and then to archive the test results.

There are several methods by which 3VA molded case circuit breakers can be tested:

- Carry out a test in offline mode using the TD500 test device and then evaluate the test results in powerconfig.
- Carry out a test in online mode using the TD500 test device and powerconfig.

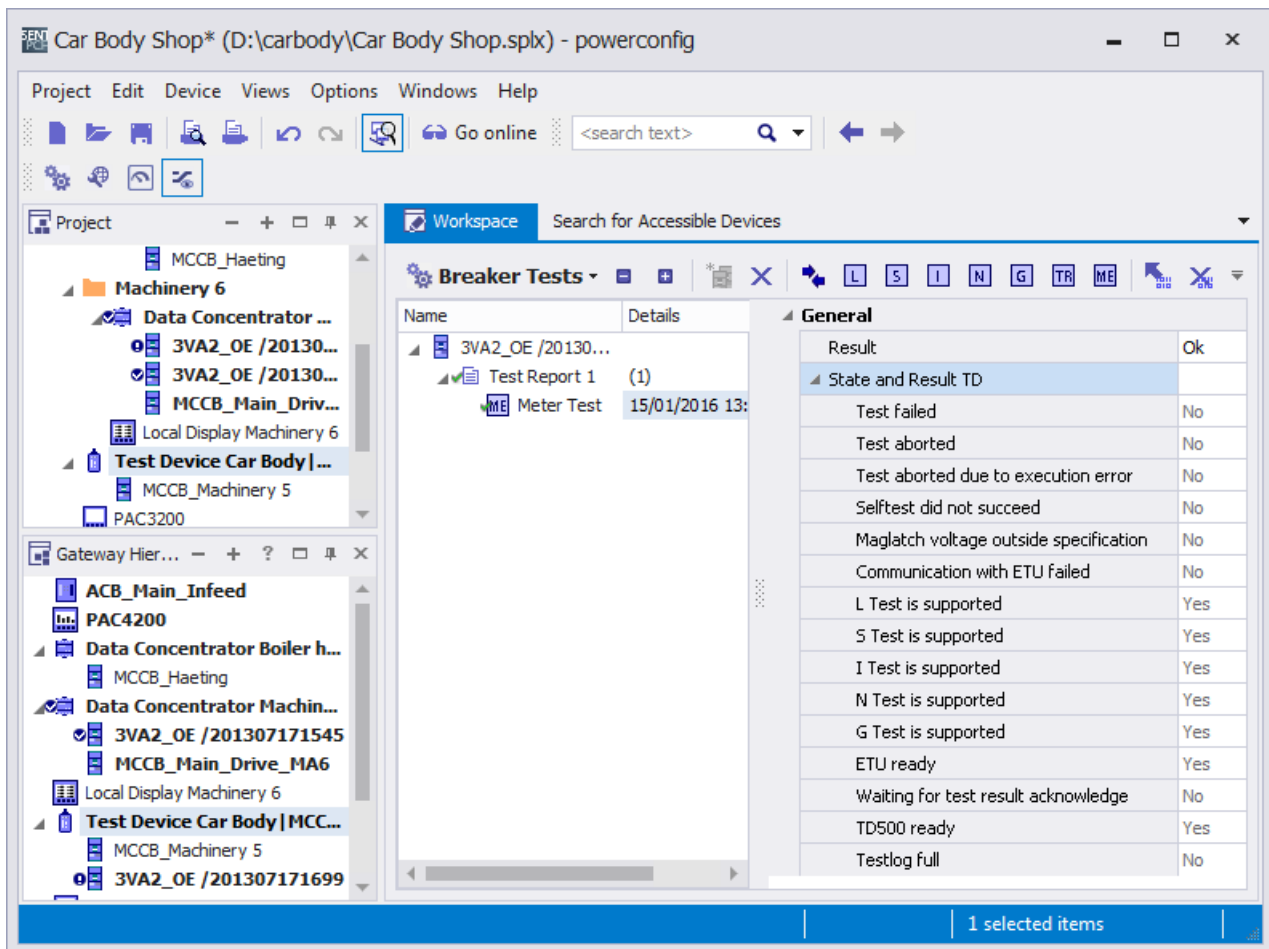

For further information about testing, please refer to Chapter "TD500 test device (Page 148)".

7.3.4 Commissioning of 3VA molded case circuit breakers

After the devices have been parameterized and tested, the installation can be commissioned.

In order to support commissioning of 3VA molded case circuit breakers, powerconfig provides online views which supply varying depths of information (details) to suit individual requirements.

Online views are activated with the icon "Activate Online View"  after the relevant device has been selected in the project.

- Overview

The overview displays key information about a 3VA molded case circuit breaker when it is in operation.

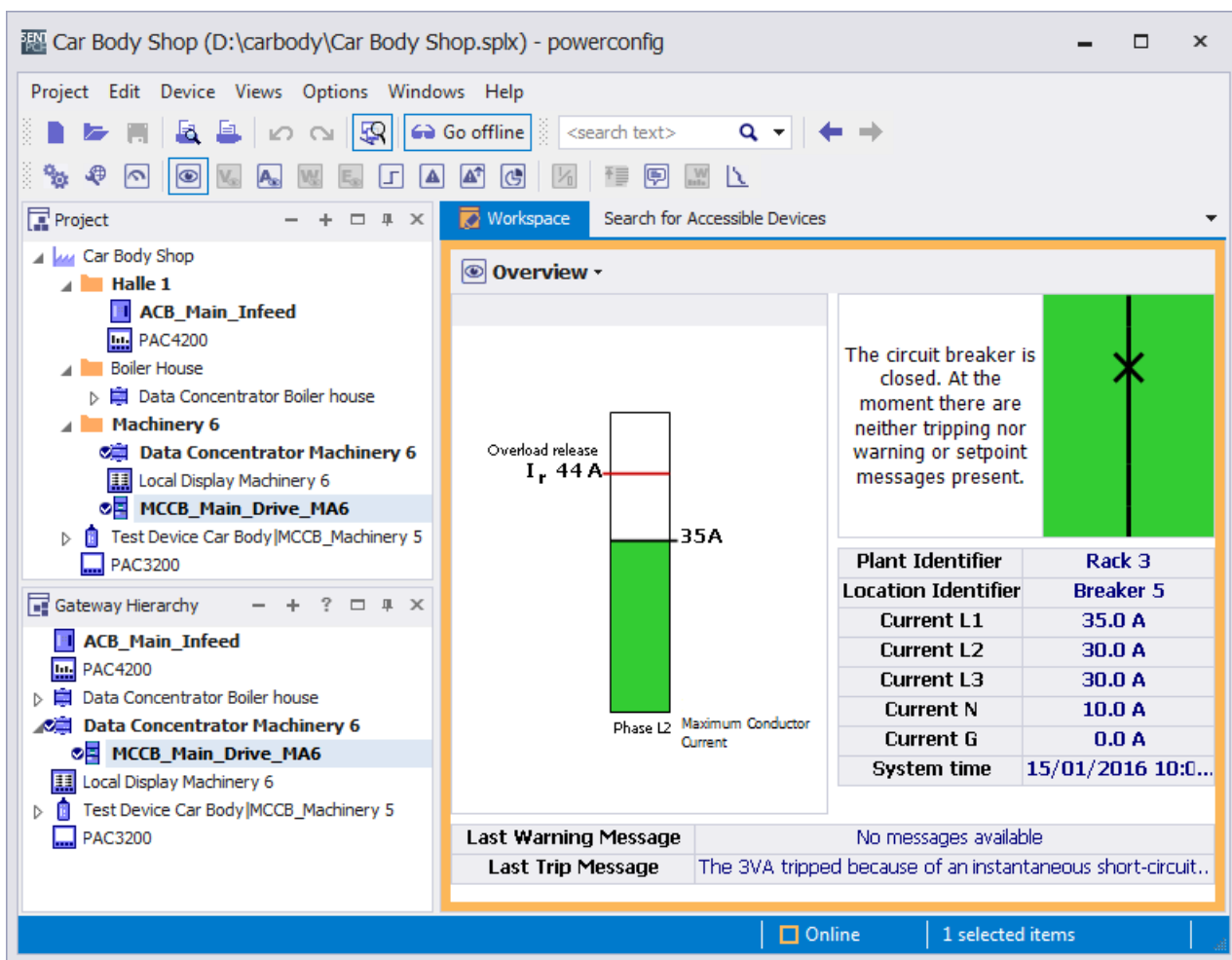

Overview

The circuit breaker is closed. At the moment there are neither tripping nor warning or setpoint messages present.

Plant Identifier	Rack 3
Location Identifier	Breaker 5
Current L1	35.0 A
Current L2	30.0 A
Current L3	30.0 A
Current N	10.0 A
Current G	0.0 A
System time	15/01/2016 10:0...

Last Warning Message: No messages available
 Last Trip Message: The 3VA tripped because of an instantaneous short-circuit..

Online | 1 selected items

- Voltage, current and power overviews

Depending on the content viewed, overviews display all information about a 3VA molded case circuit breaker pertaining to the relevant subject.

Voltage -

Instantaneous Voltage L-N

	Actual value	Minima	Maxima
L1-N	227 V	0 V - 17.12.2015 00..	235 V 17.12.2015 09
L2-N	238 V	0 V - 17.12.2015 00..	238 V 17.12.2015 09
L3-N	210 V	0 V - 17.12.2015 00..	233 V 17.12.2015 09
Ø	225 V	0 V - 17.12.2015 00..	234 V 17.12.2015 09

Current -

Instantaneous Current

	Actual Value	Minima	Maxima
L1	135 A	0 A - 17.12.2015 00..	140 A 17.12.2015 09
L2	133 A	0 A - 17.12.2015 00..	138 A 17.12.2015 09
L3	136 A	0 A - 17.12.2015 00..	140 A 17.12.2015 09
L123	136 A	0 A - 17.12.2015 00..	140 A 17.12.2015 09
Ø	5,00 A	0 A - 17.12.2015 00..	10,0 A 17.12.2015 09
G	2,40 A	0 A - 17.12.2015 00..	4,00 A 17.12.2015 09

Power -

Instantaneous Power

	Active Power	Reactive Power	Apparent Power	Power Factor
L1	26,7 W	13,0 Kvar	28,9 KVA	0,89
L2	28,0 W	14,1 Kvar	31,7 KVA	0,90
L3	25,5 W	12,2 Kvar	28,4 KVA	0,90
Σ	80,3 W	37,0 Kvar	89,3 KVA	0,90

7.3 Application types

The view "Measuring values" displays all the states and measured variables of a 3VA molded case circuit breaker.

- Measured variables and states

Some measured variables can be selected for time recording by powerconfig. The recording time can be selected between one and 60 minutes. The recording can be stored as a csv file.

The information is grouped according to subject in a tree structure.

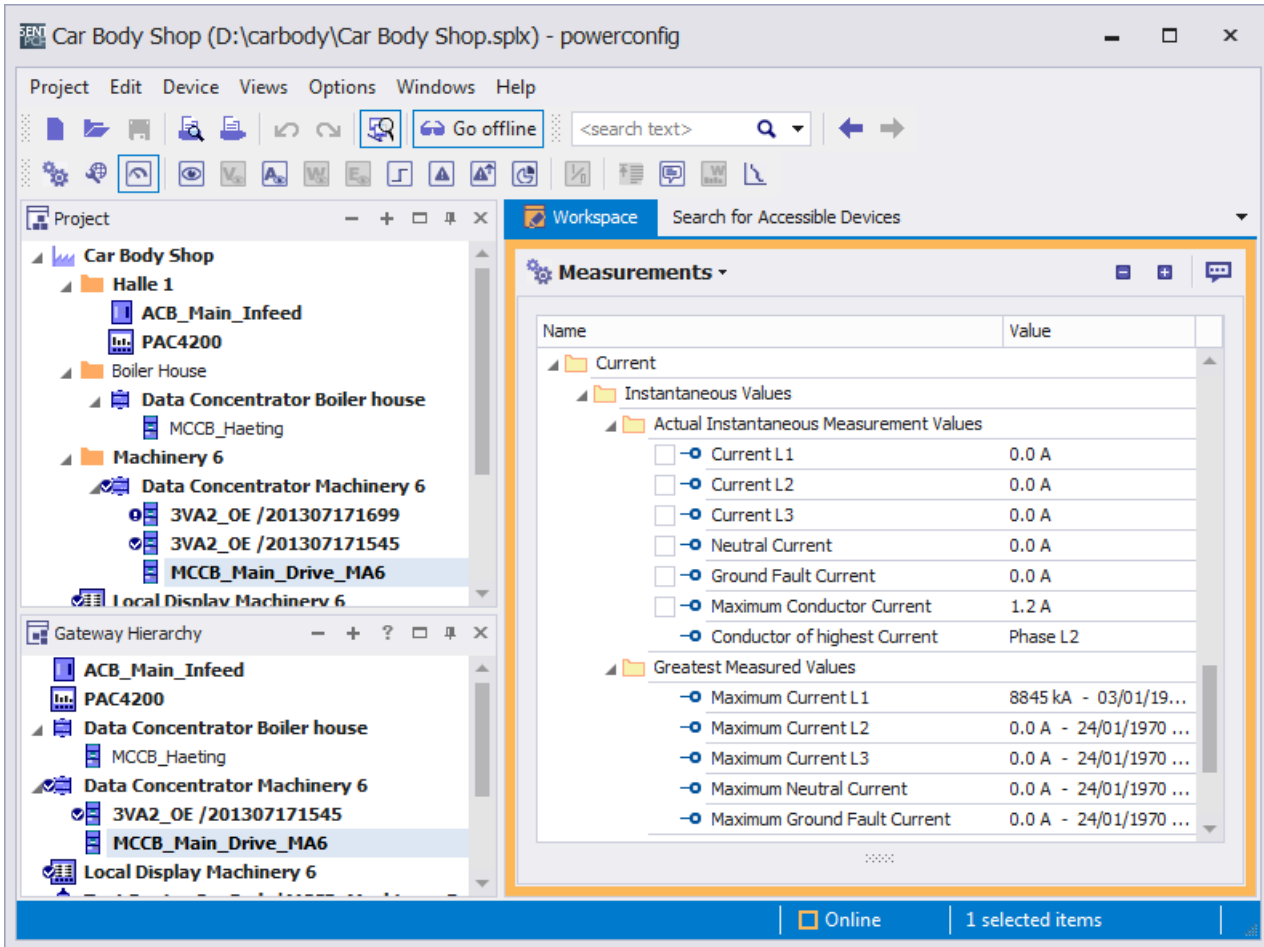

- Messages

3VA molded case circuit breakers and COM800 / COM100 breaker data servers store events (chapter "Messages (Page 72)") and processes (chapter "Understanding status transitions (Page 251)").

If the COM800 / COM100 breaker data servers are parameterized with a time synchronization function, the events and processes are displayed with a time stamp.

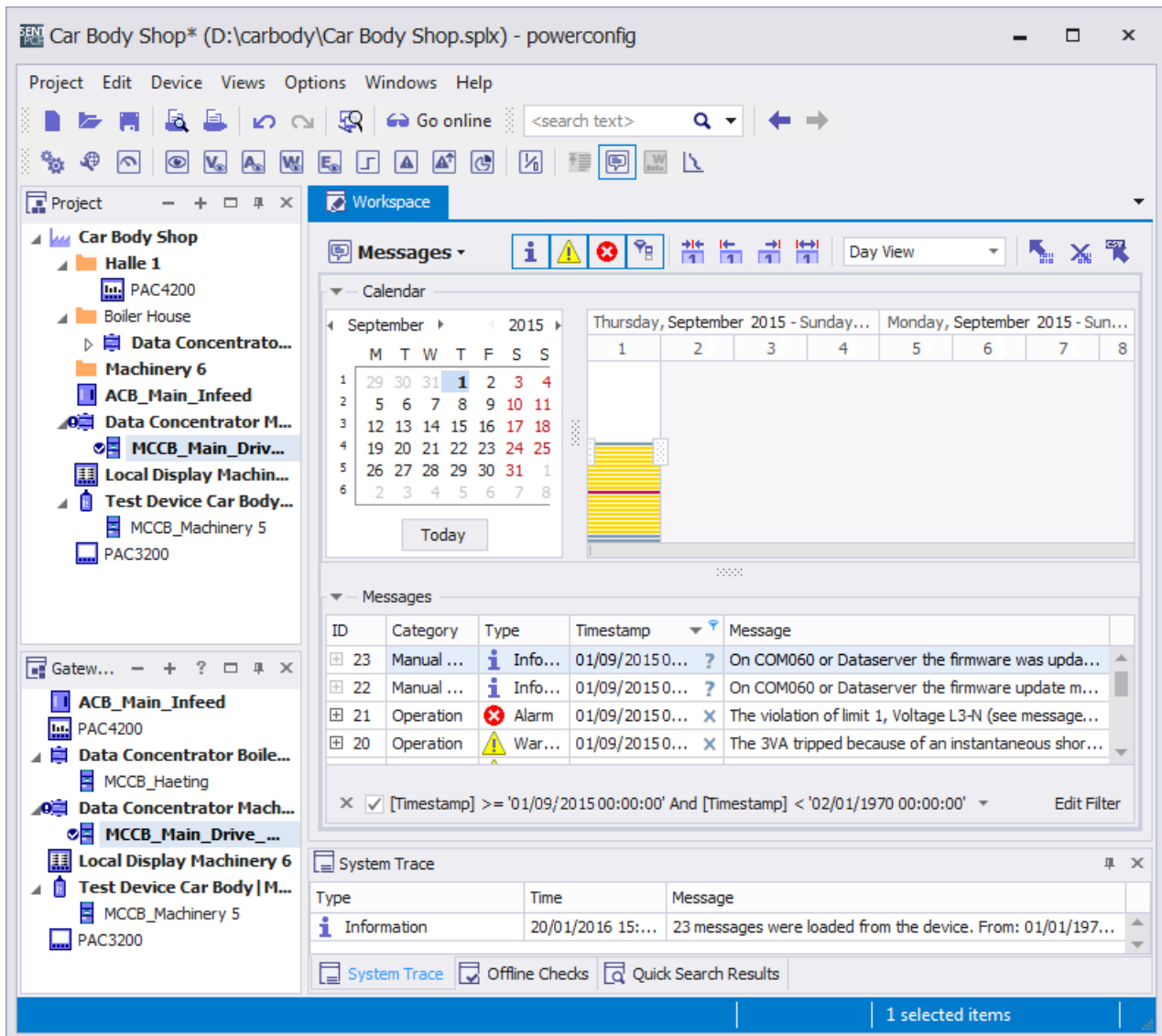

All messages or events are downloaded to powerconfig by the selected COM800 / COM100 breaker data server.

Messages can be selected and then analyzed selectively on the basis of

- categories
- types
- time ranges

If the COM800 / COM100 breaker data server is time-synchronized, chronological assignment is possible.

Messages can be archived in a file in ".csv" format.

The message buffer of the COM800 / COM100 breaker data server can be reset, i.e. its contents erased.

7.4 Configuration with powerconfig

7.4.1 From planning to installation: Top-down

The top-down procedure requires planning of the following properties throughout:

- Protection parameters
- Electrical and electronic control logic
- Network planning

The settings are transferred to the installation in the top-down procedure. The powerconfig project is usually created prior to commissioning.

7.4.1.1 Import from SIMARIS design

The device designation and the protection parameters of the protective equipment can be exported to a file from SIMARIS design:

1. SIMARIS design: Export data

⇒ *.sx

2. powerconfig: Open the *.sx file

⇒ The following information is imported into the new project:

- Hierarchical structure
- 3VA and 3VL devices including the following properties:
 - Protection parameters
 - Device designation
- In the case of unknown ETUs, (e.g. ETUs with no communication capability), an entry is made in the system protocol.
- Unknown devices are represented as folders.

The article number is transferred to the parameter description.

7.4.1.2 Create the project from the device library

All devices supported by powerconfig can be positioned in the project from the device library, and structured with the help of the "folders".

Methods of positioning devices from the device library:

- Double-click on the device type in the device library.
- Drag and drop the device type from the device library to the project
- Via the "Add" shortcut menu.

If a device is positioned within the gateway hierarchy as a child node under a gateway such as PAC4200 or COM800 / COM100, the communication channels are created automatically via the gateway in powerconfig.

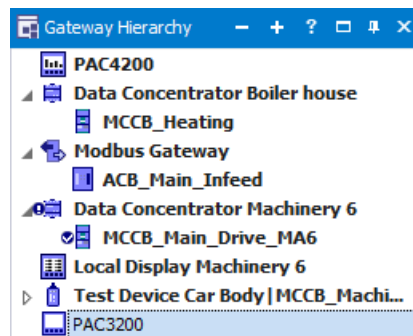

7.4.1.3 Setting the configuration parameters in the Parameters view

You can make the following settings in the Parameters view, regardless of which method you have used to position the devices in the project:

- Device name for the powerconfig software
- Plant identifier and location designation (LID) for identifying the device itself.

TIP: The device name and the plant identifier can be identical.

- Configuration is carried out by selecting the device options or by entering the article number in the case of the 3VA molded case circuit breakers.
- Configuration of the optional modules such as EFB300 or RCD820 (IEC only)
- Setting the parameters of all components in accordance with the technical documentation

7.4.1.4 Communication with the devices

To enable powerconfig to communicate with the devices, the devices must be connected with the powerconfig PC as described in chapter System description (Page 17).

To establish communication, the access channels must be correctly entered in powerconfig. The communication settings are checked and set centrally in the Communication view.

2 ... 4 sections are displayed depending on the selected device:

- PC Interface:

The PC interface for communication with the device is selected here.

- Gateway settings:

Gateway devices are selected and configured here. Two interfaces are parameterized.

- From the PC to the gateway device
- From the gateway device to the lower-level devices

- Device settings:

The interface of the target device is set here.



7.4.1.5 Searching for devices in the communication network

powerconfig can search for SENTRON devices via the PC interface . The required settings from chapter PC network settings (Page 213) must be observed here.

1. All found devices are displayed with the relevant properties, and they can be visually identified via the blinking mode depending on the device type.
2. Unlock input and enter the network addresses in the Search dialog as planned.
3. Load the network addresses from the Search dialog into the devices .

7.4.1.6 Download the parameters to the devices and check them

Download the configured devices - see chapter Configuration with the devices (Page 230) - to the devices available in the installation, and check their configuration.

1. Check and modify the parameters in the Parameters view of the respective device.
2. Compare the target configuration with the actual configuration. powerconfig offers an efficient method of comparing the parameters in the device (online) with the parameters in powerconfig (offline) .
3. Select the button  Download to device.
4. Select the correct device in the Communication view using the host address and the Modbus/breaker address, and download the device if this has not already been done.

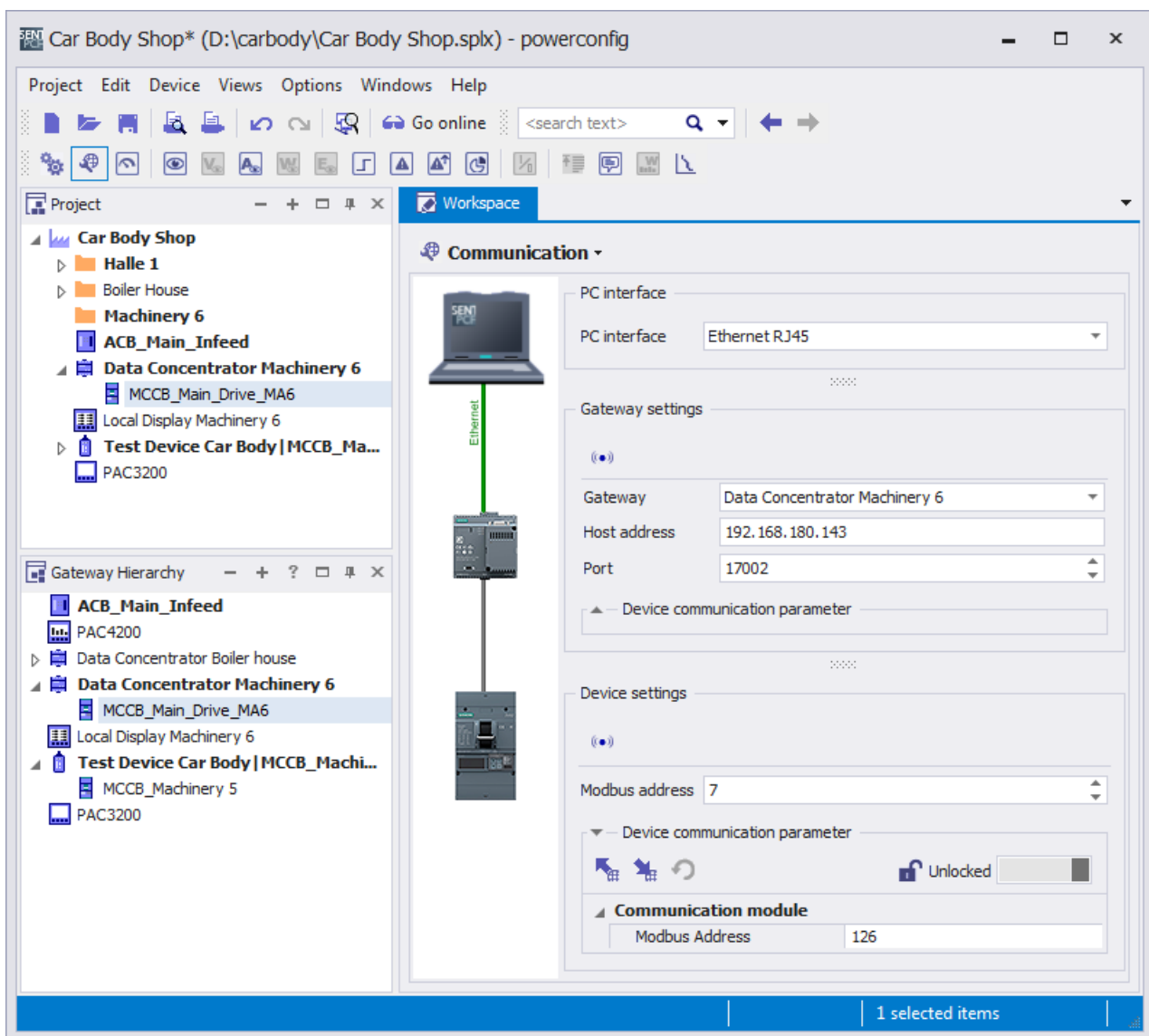

5. Download the breaker parameters from the Parameters view.

7.4.2 From installation to power monitoring: Bottom-up

The SENTRON devices are often installed in one or more facilities and then commissioned, sometimes in stages.

This procedure is also supported by powerconfig, and is described in this chapter. Planning is also required for this procedure. However, this is transferred in a bottom-up procedure to powerconfig and thus to the installation.

7.4.2.1 Installation of the devices and communication channels (pre-installation)

The devices must be installed and supplied with power. See chapter Supply voltages and grounding system (Page 104).

To enable powerconfig to communicate with the devices, the devices must be connected with the powerconfig PC via one of the possible networks. See chapter System description (Page 17).



7.4.2.2 Searching for devices in the communication network

powerconfig can search for SENTRON devices via various PC interfaces .

The required settings in chapter Network settings (Page 213) must be observed here.

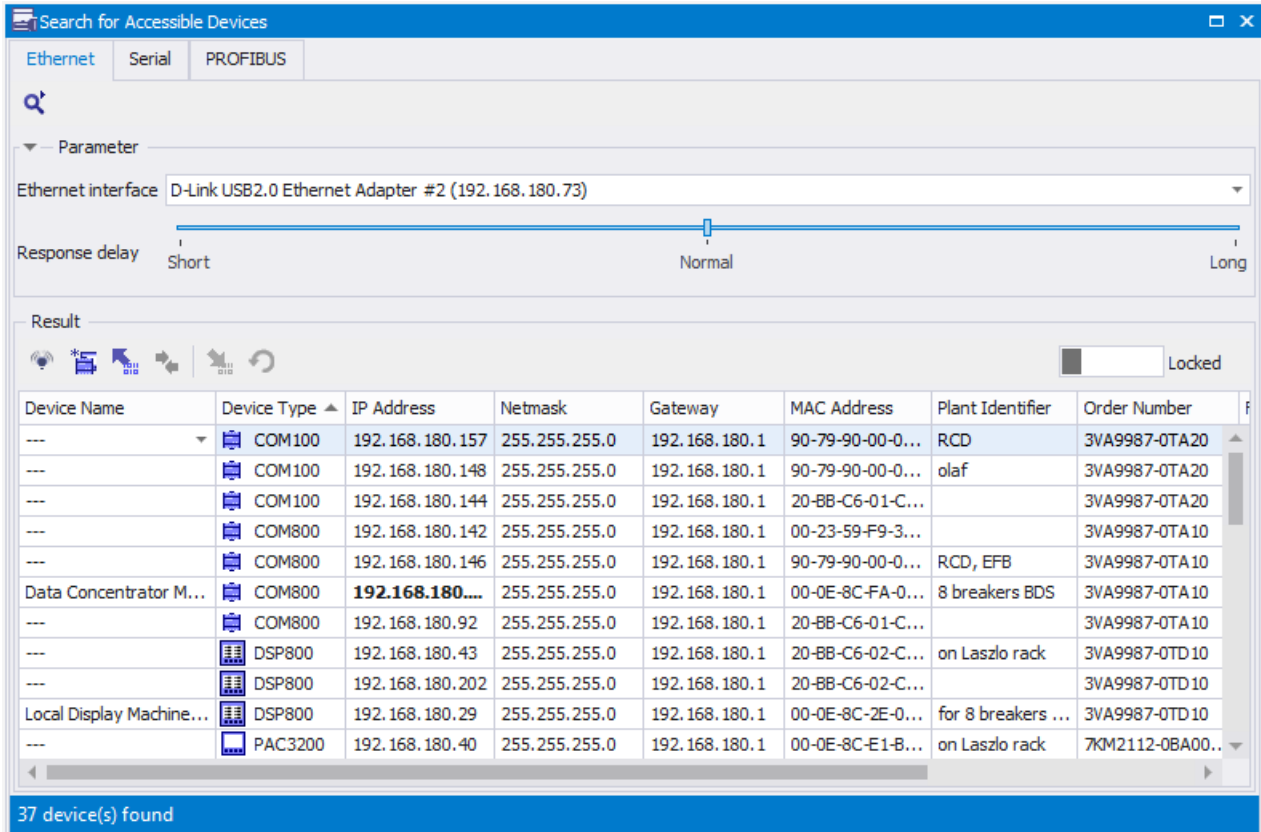
1. Use the Search dialog to search every PC interface of powerconfig for SENTRON devices.
A list of found devices is displayed for each network.



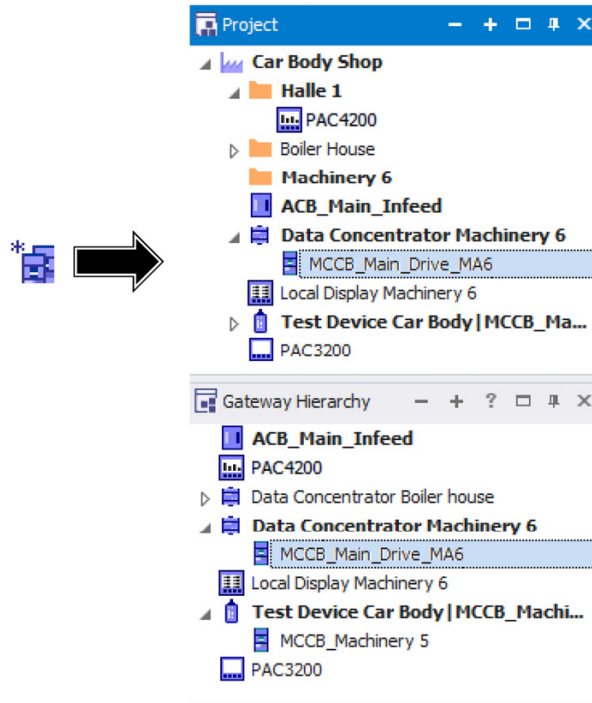

2. Device identification:
The devices are identified by means of the device type, the article number and the MAC address printed on the device. They can also be identified visually by means of the blinking mode .
3. Unlock the dialog  and enter the network addresses and plant identifiers.

- 4. Transfer devices and their communication settings from the Search dialog to the powerconfig project





- 5. Download  the selection from the Search dialog to the devices.

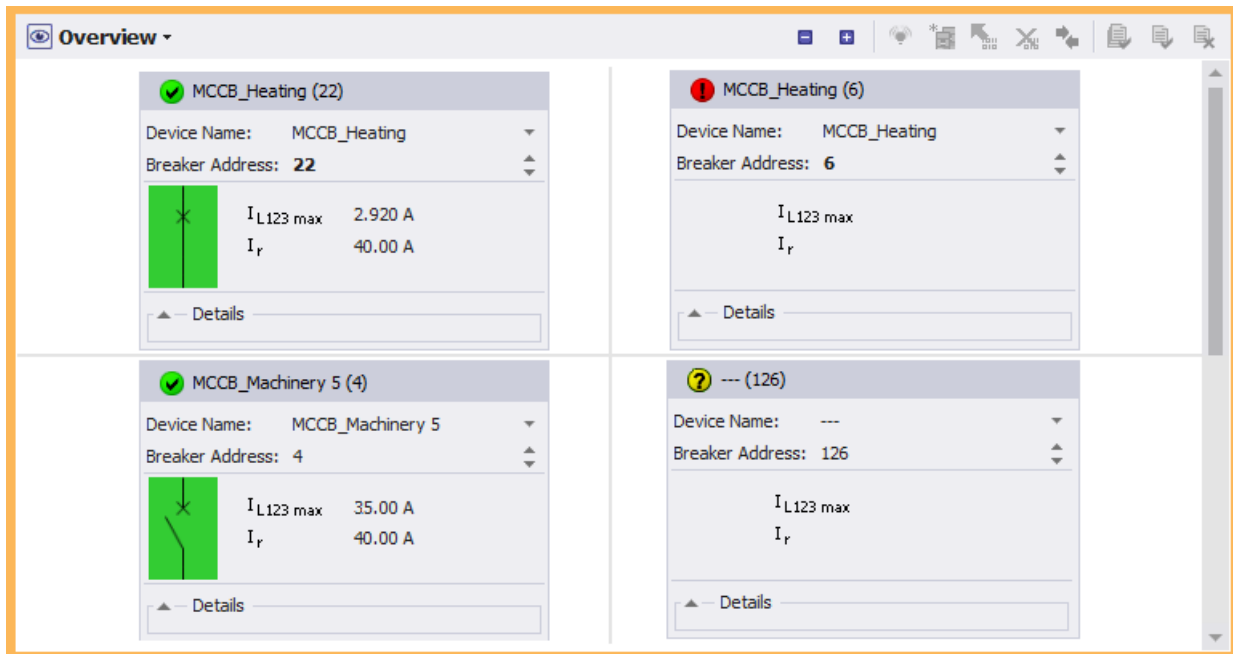

7.4.2.3 Transferring 3VA molded case circuit breakers into the powerconfig project

1. Select the COM100 / COM800 breaker data server in the project tree or in the gateway hierarchy.
2. For 3VA COM100 / COM800, select the Overview  view and go online . The 3VA breakers connected to the COM100 / 800 appear.



3. Assign a breaker address that is not equal to 126 (e.g. 1 - 8) to each 3VA breaker.
4. Confirm the configuration  .
5. Transfer the 3VA breaker to the project .

7.4.2.4 Transfer the device configuration and parameters to the powerconfig project

1. For each device, select the Parameters view  and download the configuration and parameters  to powerconfig.
2. Adapt the parameters in the Parameters view  to the target data, and download them again to the devices .

7.4.3 Commission the installation with powerconfig

powerconfig offers diverse online functions  for monitoring and verifying the commissioning of an installation, e.g. display of voltage, currents, and power values



See also

TD500 test device (Page 148)

7.4.4 Archiving and documenting the installation with powerconfig

As soon as commissioning of the installation has been completed, the powerconfig project can be printed out for documentation purposes.

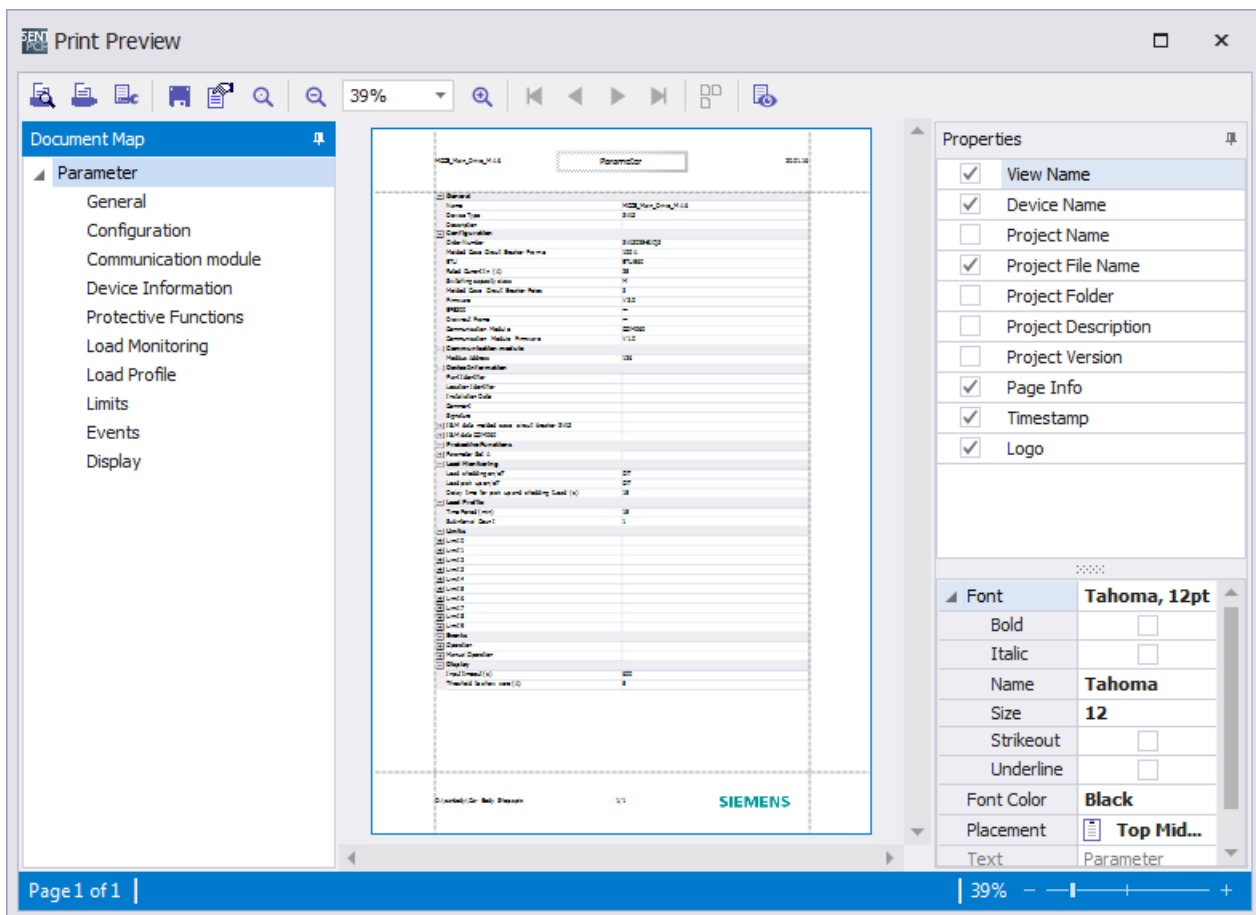

The powerconfig project must at all costs be archived and backed up.

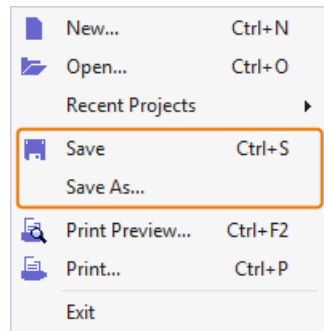

7.4.5 Continuing to use results from powerconfig in powermanager

The project created with powerconfig can be exported as a powermanager.csv file.

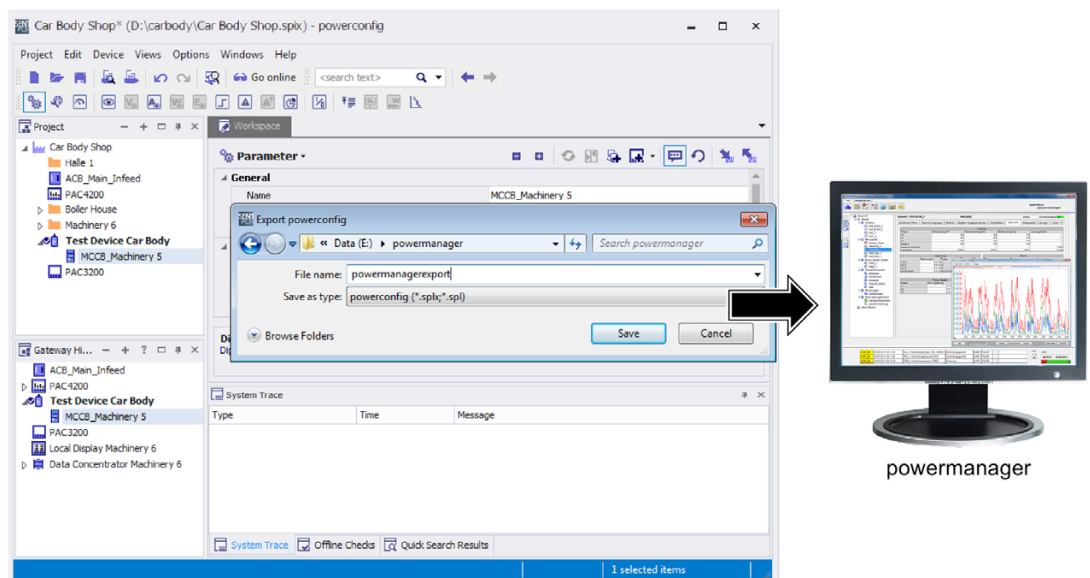

This powermanager.csv file with device name, device type, and communication settings can be imported into powermanager.

The devices are thus available in powermanager with the same names and network addresses.

7.4.6 Maintaining an installation with powerconfig

Maintaining an installation means analyzing the past of the installation and introducing appropriate measures when required. The individual communication-enabled SENTRON devices, e.g. COM800 / COM100, PAC4200, offer recording of important information that can be evaluated with powerconfig.

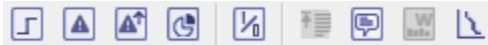

The installation's past can be represented in different time ranges.

Short-term:

- Last trip reason(s)
- Pending warnings of the protective functions
- User-defined threshold values

Mid-term:

- Load profiles show the load curve of the last 4000 periods, in other words, approximately 40 days in the case of a period duration of 15 minutes.
- For operational messages, operator action messages, and system messages, see chapter Messages (Page 72).

Long-term:

- Trip archives
- Maintenance and statistical values, e.g. trip counter and operating hours counter

With this information and powerconfig, an installation can be efficiently maintained, and its service life and availability significantly increased.

7.5 IP addressing

IP communication is the basis of the Ethernet-based SENTRON communication, and thus the communication basis of powerconfig. To enable effective addressing with powerconfig, the addressing options are presented below. IP communication including IP addressing is used both for a subnet and for global communication.

IP addressing encompasses addressing of the individual subnets and the individual network nodes, e.g. SENTRON devices.

You can find more information on planning the IP addresses in chapter Planning the communication networks (Page 106).

7.5.1 IP addressing with fixed IP addresses

Fixed IPv4 addresses offer a simple option for addressing nodes (=devices) in manageable local networks without external network access.

The subnet mask is exactly the same length as an IPv4 address, i.e. 32 bits. All bits of the network section are set to 1, and all bits of the device section have the value 0. The network section of an IPv4 address is produced from bit-wise logic AND combination with the network mask.

Example

	IP V4 address	11000000 10101000 00000001 10000001
AND	Subnet mask	11111111 11111111 11111111 00000000
=	Network section = Subnet address	11000000 10101000 00000001 00000000

	IP V4 address	11000000 10101000 00000001 10000001
AND	NOT subnet mask	00000000 00000000 00000000 11111111
=	Node address = Device address	00000000 00000000 00000000 10000001

The parts of the subnet mask with 255 are used for subnet addressing, and the parts with 0 for node addressing.

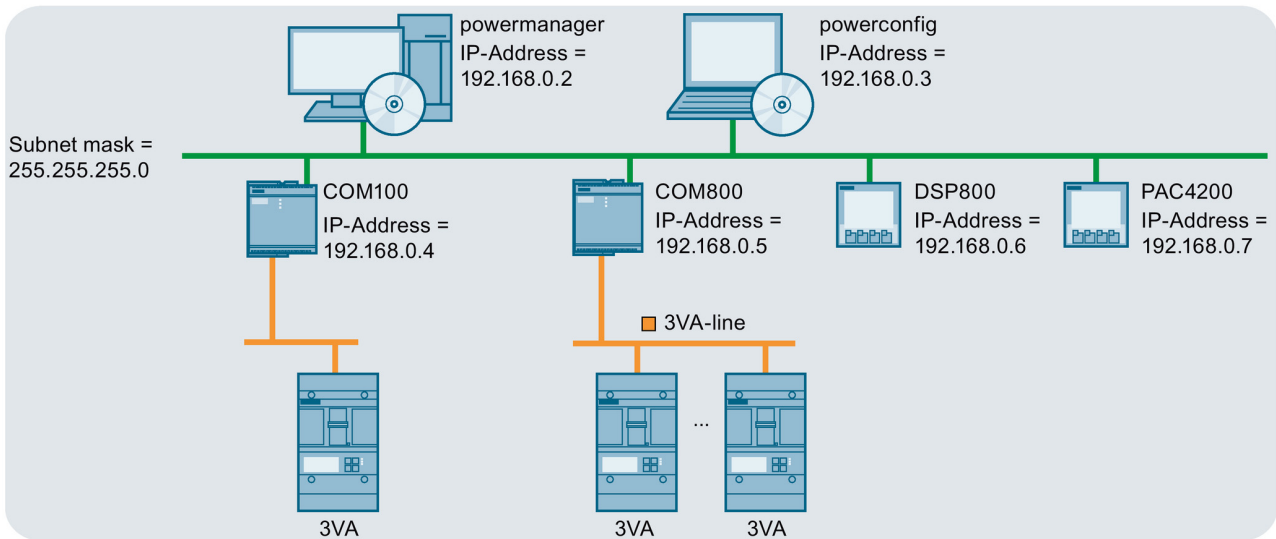

The IP addresses of the SENTRON devices can be assigned in powerconfig, in the Search dialog, for example. See chapter Searching for devices in the communication network (Page 230).

7.5.2 IP addressing via name

In larger subnets, such as those with more than 255 nodes of different types and origin, you are recommended to manage the IP addresses in a DNS. Names are assigned to numbers here, similarly to telephone books. The numbers (= IP addresses) can be determined with the help of device names.

For this reason, a name can be entered in powerconfig (Version 3.4 and higher) in all fields designated "Host address". This name is converted to an IP address by powerconfig via a DNS server.

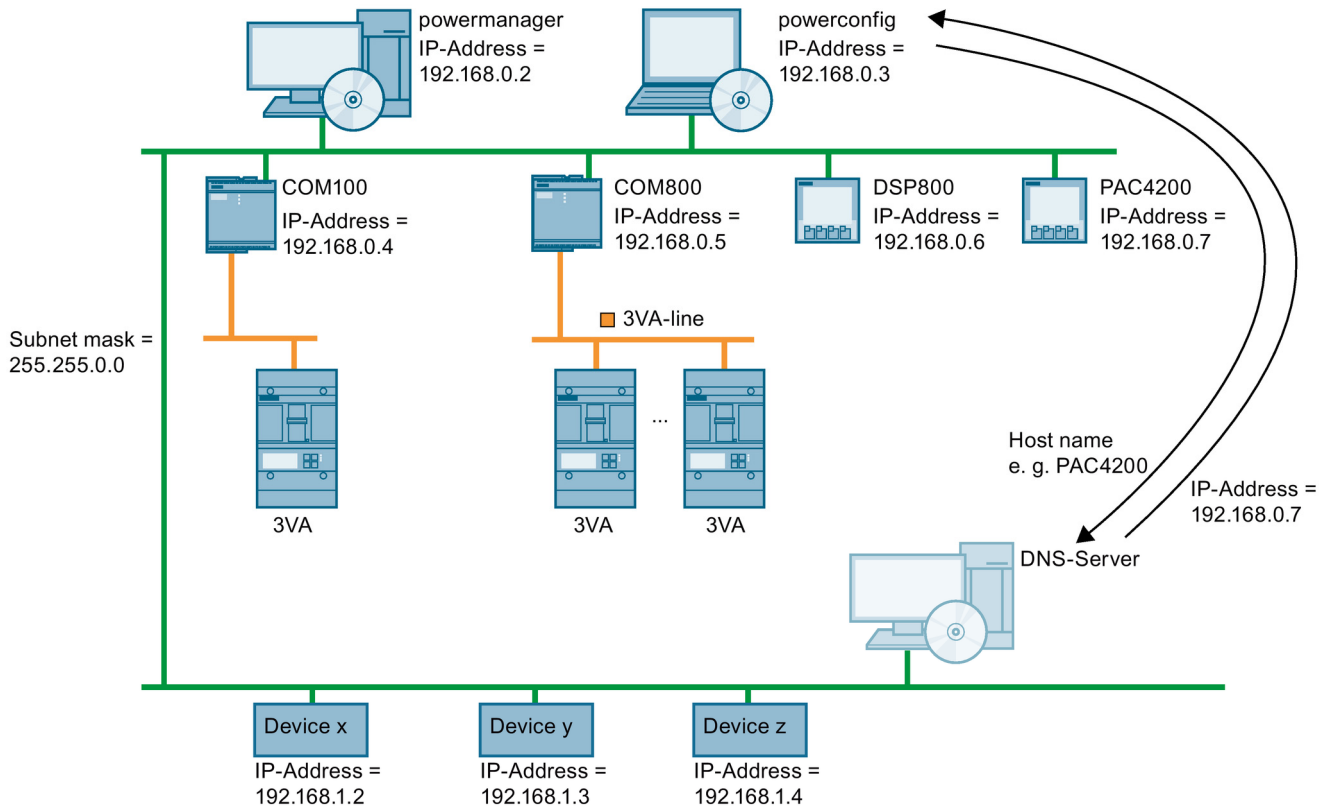

The settings for the DNS server are made in Windows as a "property of Internet Protocol Version 4 (TCP/IP)".

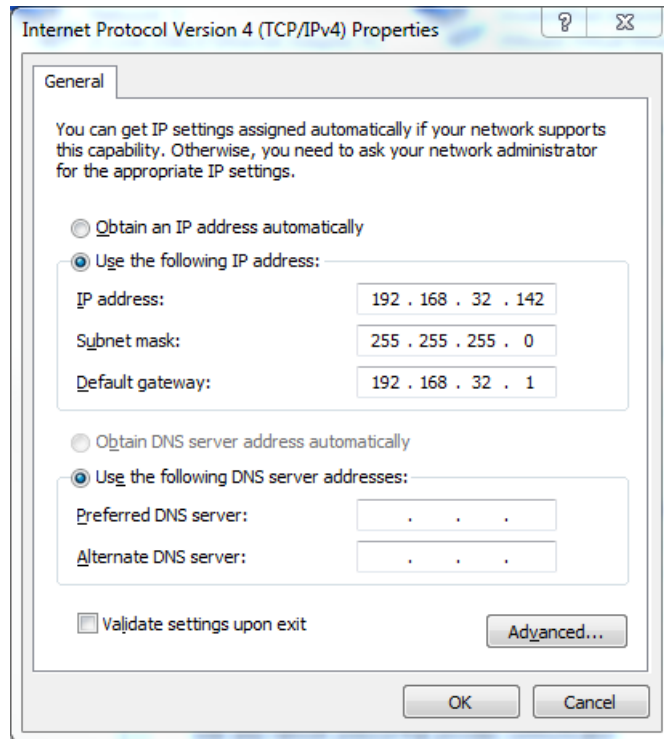

For this purpose, the SENTRON devices to be addressed using names must be entered in the local DNS server with names and IP addresses, together with the other network nodes.

The DNS is maintained by the system administrator.

7.5.3 IP addressing from the Internet

On the Internet, the IP addresses are assigned by Internet service providers as required and periodically. This is done via a DNS (Domain Name System) vendor such as dyndns.org. While fixed IP addresses are possible in principle, they are expensive and time-consuming to procure.

DNS is used to enable use of the dynamic IP addresses with powerconfig. For this purpose, the individual devices must be assigned a host address and stored in a DNS, e.g. dyndns.org.

Example

In the field "Host address", users enter the stored name exactly, in this case, "Machine-6.dyndns.org".

Port forwarding can be used as well as DNS for addressing several devices in an installation. The port forwarding table must be completed in the router (firewall) for this purpose. In this table, an installation-internal IP address with port is assigned to a host address and an external port, here, for example, 502.

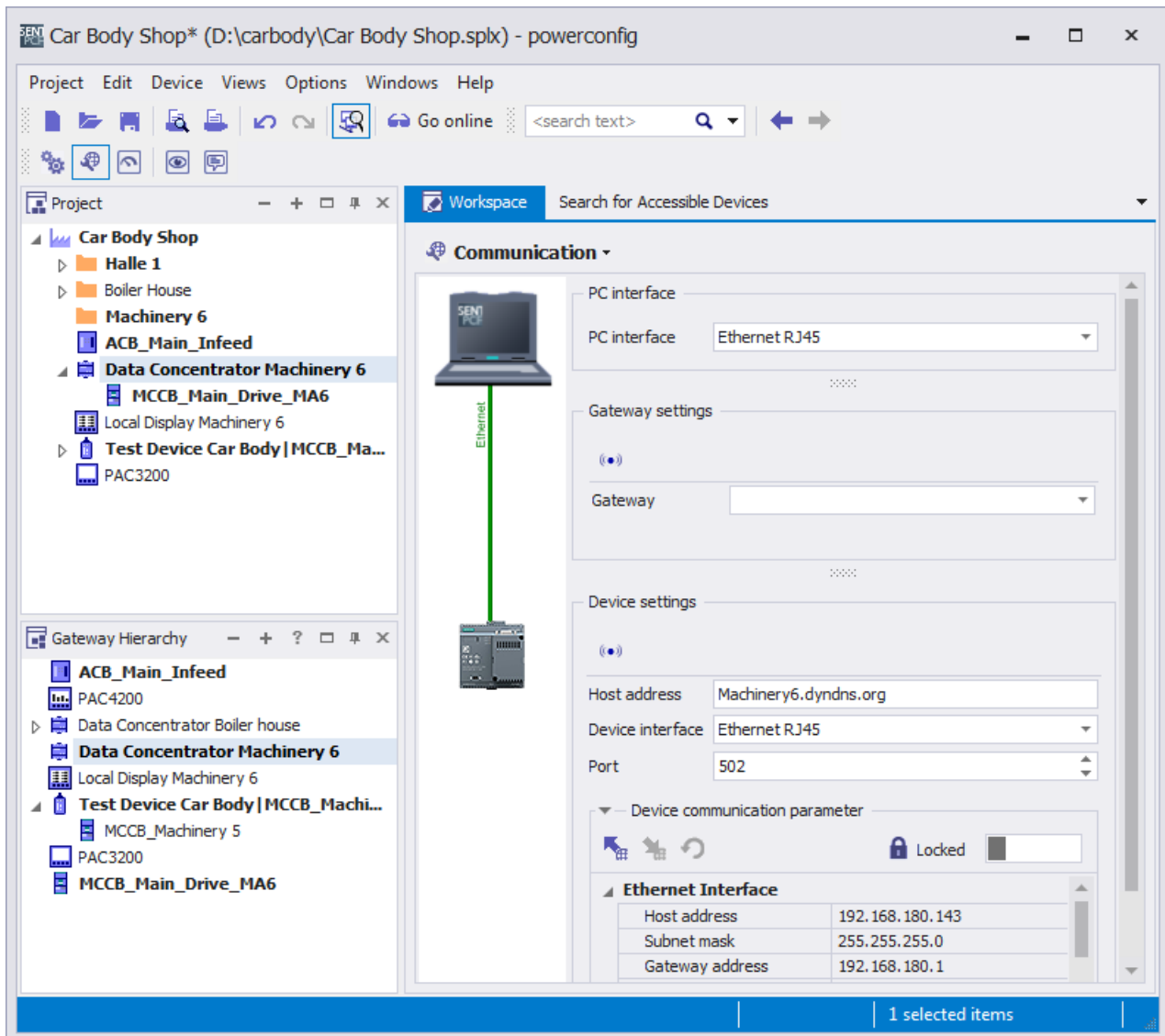

Despite the firewall and port forwarding, access via the Internet creates weak points in information security. For this reason, write authorizations and firmware update functions must be appropriately protected in such installation configurations, using write-protection switches (3VA) or the write-protection bridge, for example.

Service and maintenance

8.1 Firmware update

The firmware of individual electronic components can be updated. This is particularly helpful in ensuring smooth interoperation between different electronic or software components.

Firmware updates may be necessary to

- equip existing components with additional functions
- optimize the interaction of current and existing components
- improve performance.

Firmware updates are announced and made available via the Siemens Industrial Online Support (<https://support.industry.siemens.com/cs/ww/en/ps/19515/dl>).

Note

Backup of device parameters

It is recommended that device parameters are backed up on the PC before a firmware update is carried out, see chapter Parameterizing 3VA molded case circuit breakers (Page 222).

Using menu commands Device > Update in powerconfig, it is possible to update the firmware of the following devices:

- COM800 / COM100 breaker data server via device interface Ethernet RJ45
- COM060 communication module via the device interface of the COM800 / COM100 Ethernet RJ45
- 7KM PAC RS 485 expansion module via the device interface of the COM800 / COM100 Ethernet RJ45
- 7KM PAC PROFIBUS DP expansion module via device interface of COM800 / COM100 Ethernet RJ45
- 7KM PAC Switched Ethernet PROFINET expansion module via Ethernet interfaces of the Switched Ethernet PROFINET expansion module
- TD500 test device via USB interface

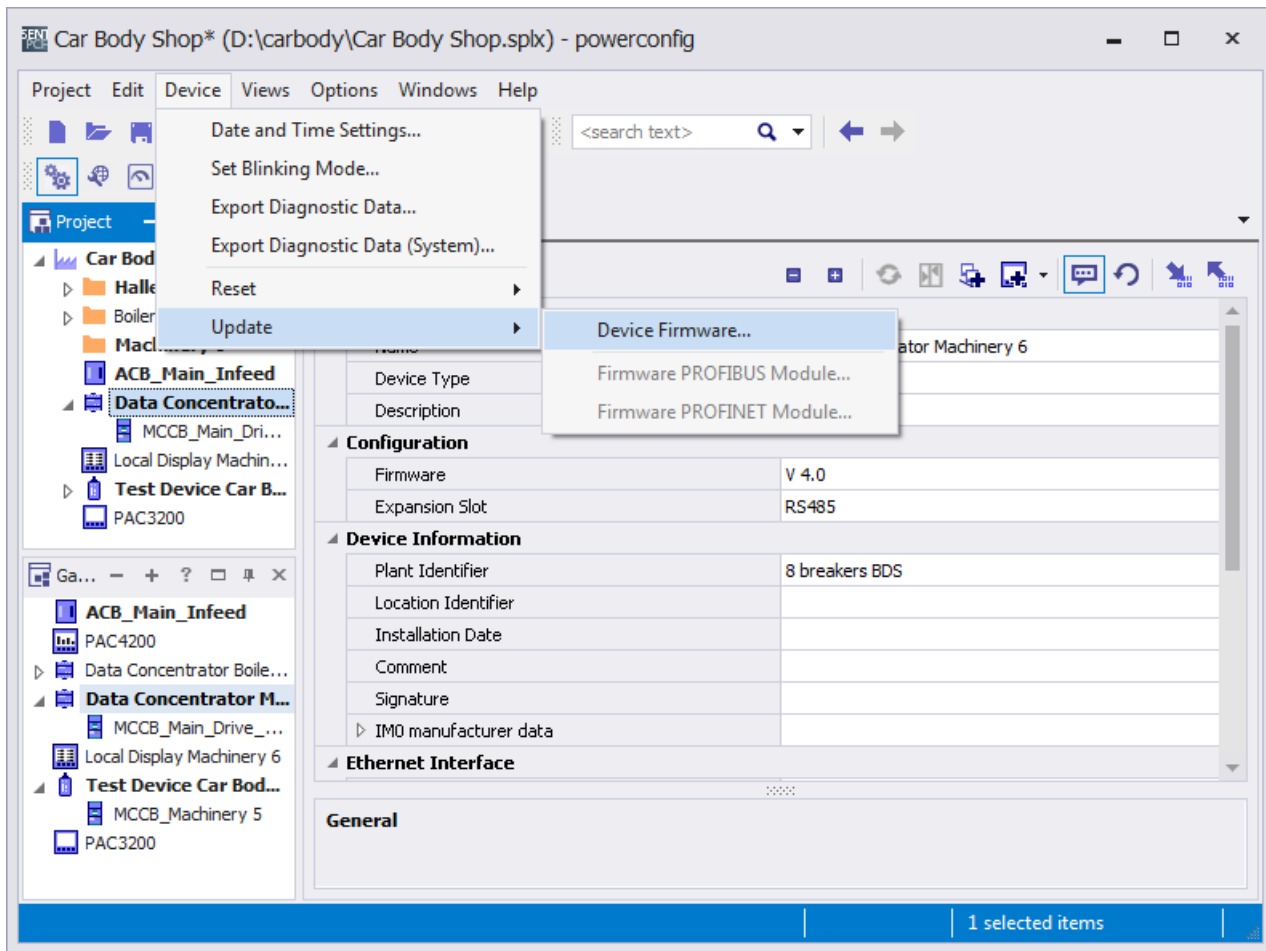

Note

It is important to ensure that additional communications are not active while the firmware of the COM800 / COM100 or COM060 is being updated. If other connections are active the update process is refused.



8.2 Replacing the 3VA molded case circuit breaker connected to a COM800 / COM100

3VA molded case circuit breakers wear as a result of switching and tripping operations. It may be necessary to replace a 3VA molded case circuit breaker.

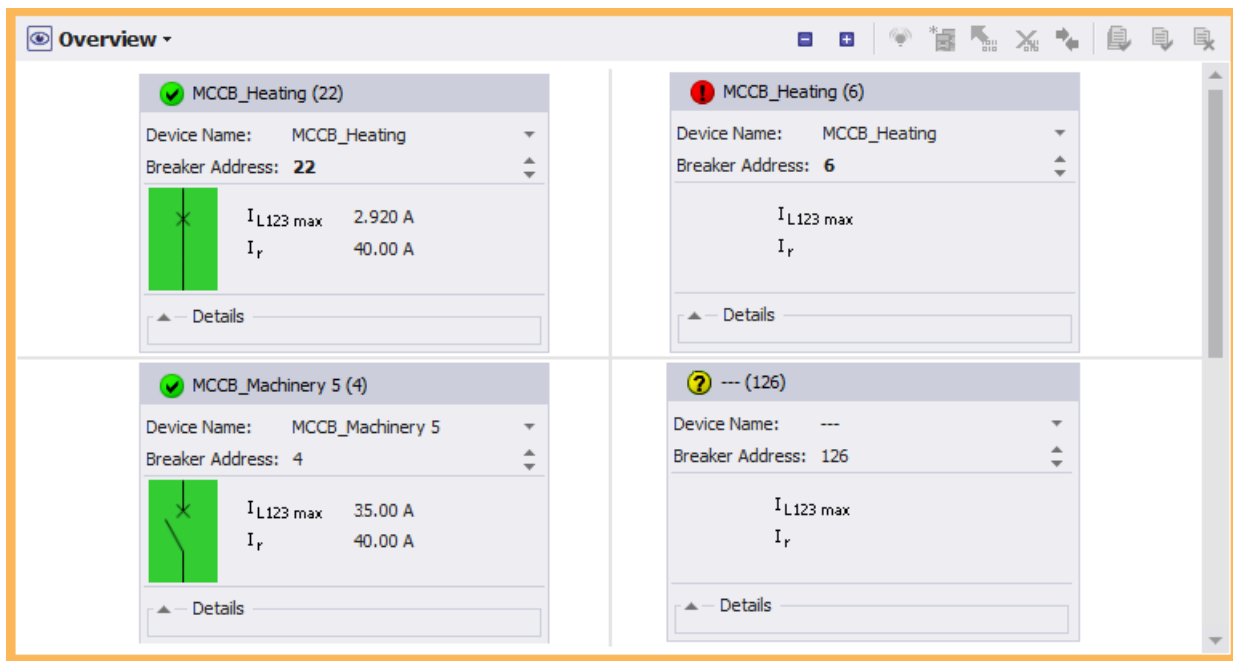
Replace the circuit breaker and the COM060.



The correct procedure for replacing a 3VA molded case circuit breaker in the 3VA-line and therefore at the COM800 / COM100 breaker data server is described below:

1. Back up the database of the 3VA molded case circuit breaker to be replaced:
 - Set up a project for the 3VA molded case circuit breaker to be replaced if it is not already contained in the project.
 - Use the icon  in the Parameters view to download the data of the 3VA molded case circuit breaker to the PC.
 - Assign a name to this 3VA molded case circuit breaker if this has not already been done.
 - Make a note of this name
2. Change the address of the old 3VA molded case circuit breaker so that the existing address can be used for the new circuit breaker:
 - Select the COM800/COM100 on which the 3VA molded case circuit breakers is to be replaced and go online .
 - Change to the "Overview" view.
 - Make a note of the existing breaker address.
 - Change the address of the old circuit breaker to a free address or to breaker address **126**.

8.2 Replacing the 3VA molded case circuit breaker connected to a COM800 / COM100

3. Replace the 3VA molded case circuit breaker
 - Disconnect the old 3VA molded case circuit breaker from the 3VA-line by removing the COM060 cable from the corresponding T-connector.
 - Remove the old 3VA molded case circuit breaker.
 - Install the new 3VA molded case circuit breaker.
 - Connect the new 3VA molded case circuit breaker with the new COM060 by means of the spur line to the T-connector of the 3VA-line.
 - The new 3VA molded case circuit breaker will be detected as 126, see chapter "Commissioning the 3VA on COM800 / COM100 (Page 119)".

4. Commission the new 3VA molded case circuit breaker:



Particular attention must be paid to the protection parameters, and metering and communication functions during recommissioning.

The protection parameter settings always depend on the required protection levels and on the protective device itself. This must be taken into account when the protection parameters are transferred:



When a 3VA molded case circuit breaker is replaced by a unit of exactly the same type, it is permissible to transfer the protection parameters of the old device to the new one.

When a 3VA molded case circuit breaker is replaced by a unit of a different type, the protection parameter settings must be changed accordingly, see chapter "Commissioning 3VA on COM800 / COM100 (Page 119)".

As long as the parameters are in the permissible value range of the new 3VA molded case circuit breaker they are transferred unchanged. If the parameters are not in the permissible value range of the 3VA molded case circuit breaker they are adjusted to the next possible permissible value range.

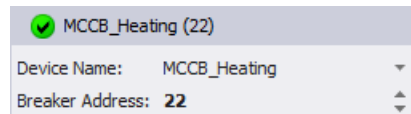
- Assign the breaker address of the old 3VA molded case circuit breaker to the new one and activate the modified configuration by selecting the icon . See view "Overview for COM800 / COM100".
→ The status of the 3VA molded case circuit breaker changes to the communication-capable state .
- Assign the name of the original breaker to the new one, for example, using the selection list at the device name.



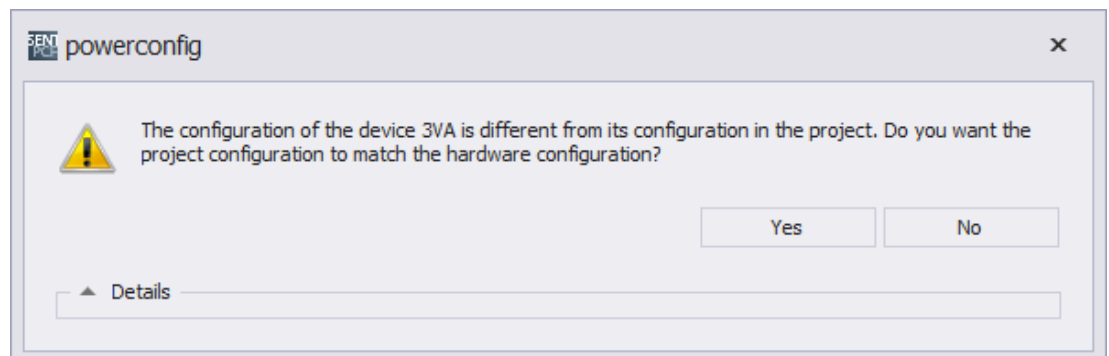

- Select the field with the green hook and synchronize the new circuit breaker .
- Leave online mode by clicking on icon  again
- Select the name of the saved 3VA molded case circuit breaker.
- Download the parameters of the old 3VA molded case circuit breaker to the new one by selecting icon  in the Parameters view.
→ If the configuration (technical data, article number) of the new 3VA molded case circuit breaker does not exactly match that of the old one the following dialog box will be displayed.

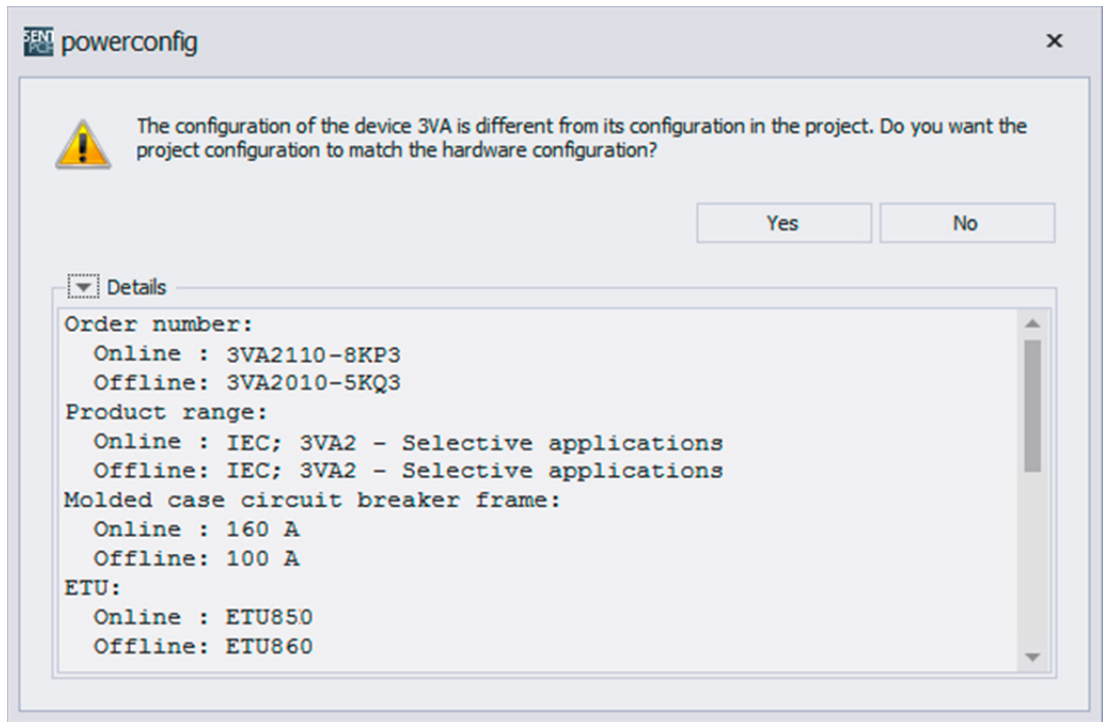

- Check the details to see whether the differences are acceptable. If they are, click "Yes".
→ The parameters of the original 3VA molded case circuit breaker are transferred to the new one. → If they are not, install a 3VA molded case circuit breaker with which the protection functions can be fulfilled in accordance with the saved parameters.



5. Test the communication link with the communication partner:
 - SIMATIC S7: Use STEP 7 to check the status of the DP slave or the PROFINET IO device.
 - powermanager: Check the communication status and value updates.
6. In a final step the breakers that are not required should be deleted in the "Overview" view so that COM100/COM800 receive a confirmed configuration.
→ The following actions are required to ensure that the green COM-LED lights up:
 - Select the "Overview" view and go online .
 - Delete the breakers that you do not need .

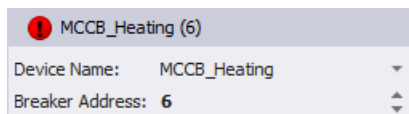

8.3 Understanding status transitions

Events are logged in the communication system of the 3VA molded case circuit breaker. These can be evaluated to better understand transitions between operating states as well as user actions and faults.

With powerconfig, the events of the 3VA molded case circuit breaker communication system are displayed in the "Messages"  view.

8.3 Understanding status transitions

Category	Messages	Possible user measures
Changes to 3VA configuration of the COM800 / COM100 breaker data server		
Operator action message	The configuration of the 3VA molded case circuit breakers connected to the 3VA-line has been declared valid. Deviations are detected.	None because user action.
Operator action message	The 3VA molded case circuit breaker has been removed from the configuration by an operator action.	None because user action.
Operator action message	The 3VA molded case circuit breaker has been added to the configuration by an operator action.	None because user action.
Changes in operating state of the COM800 / COM100 breaker data server		
System message	Communication has been established.	None, for information only.
System message	COM800 / COM100 has been switched on.	None, for information only.
System message	Time synchronization from SNTP server has failed.	Check whether the SNTP server can be accessed via the communication network. If it cannot, restore the communication link.
Changes to the COM800 / COM100 breaker data server		
Operator action message	[Minimum and maximum values of [measured variable] have been reset].	None because user action.
Operator action message	[All minimum and maximum values have been reset] ([measured variable = 0]).	None because user action.
Operator action message	Event memory has been restarted after a reset.	None, because previous messages have been deleted.
Parameter message	Overload release I _r (A) has been changed.	None because user action.
Operator action message	COM800 / COM100 has been reset to the delivery state.	None because user action.
Operator action message	COM800 / COM100 has been reset to the delivery state except for the communication settings.	None because user action.
Operator action message	The time was set on xx.xx.2014.	None because user action.
Changes to operating state of the COM800 / COM100 breaker data server		
System message	COM800 / COM100 has been switched on.	None, for information only.
Power supply disturbances		
System message	Power supply at risk.	Check supply voltage, take measures to protect supply if necessary. It is possible that more than the maximum permissible number of 3VA molded case circuit breakers is connected to the COM800 / C100 breaker data server.
System message	3VA power supply at risk.	It is possible that more than 8 3VA molded case circuit breakers are connected to the COM800 / C100 breaker data server.
System message	Power supply interrupted.	Determine the reason for the interruption to the power supply. Take protective measures if necessary.
System message	3VA power supply has been interrupted.	Too many 3VA molded case circuit breakers are connected OR the 3VA-line cable is defective OR a COM060 communication module in a 3VA molded case circuit breaker is defective.
Firmware update messages		
System message	A 3VA has a more recent firmware version than the COM800 / COM100.	Update the firmware of the COM800 / COM100.
Operator action message	Firmware update mode has been activated for the COM060 or COM800 / COM100.	Wait for the firmware update process to complete.
Operator action message	Firmware update mode has been aborted for the COM060 or COM800 / COM100.	Repeat the firmware update process.
Operator action message	The firmware of the COM060 or COM800 / COM100 has been updated from [old version] to [new version].	None, for information only.

8.4 What to do in the event of communication faults

The procedure is divided into three steps to limit communication faults.

- Communication between external communication partner and COM800 / COM100 breaker data server
- Communication between COM800 / COM100 breaker data server and 3VA molded case circuit breakers with COM060
- Agreement of the breaker address with the external communication partner

8.4.1 Check communication between COM800 / COM100 breaker data server and external partner

When faults develop in the communication link between an external communication partner and a COM800 / COM100 breaker data server, proceed as follows:

Check the external communication capability by means of the LEDs:

- "LAN" on COM800 / COM100 breaker data server, see chapter "LED display (Page 112)".
- "DIAG" on the 7KM PAC PROFIBUS DP expansion module, see chapter "LED display (Page 112)".
- "DIAG" on 7KM PAC Switched Ethernet PROFINET expansion module, see chapter "LED display (Page 112)".
- "DIAG" on the 7KM RS 485 expansion module, check the RS 485 structure, see chapter "Connection of the 7KM PAC RS 485 expansion module (Page 196)"

If faults still persist between the communication partner (e.g. powermanager) and the COM800 / COM100 breaker data server, a check should first be performed to determine whether the COM800 / COM100 breaker data server is generally accessible.

Proceed as follows to ensure that the COM800 / COM100 breaker data server can be accessed from the subnet:

1. Position powerconfig on the same subnet as the communication partner, and if applicable, on the same PC.
2. Check whether the settings required to search for accessible devices have been entered, see chapter "PC network settings (Page 213)".

3. Use the icon "Search for devices"  to search for accessible devices.

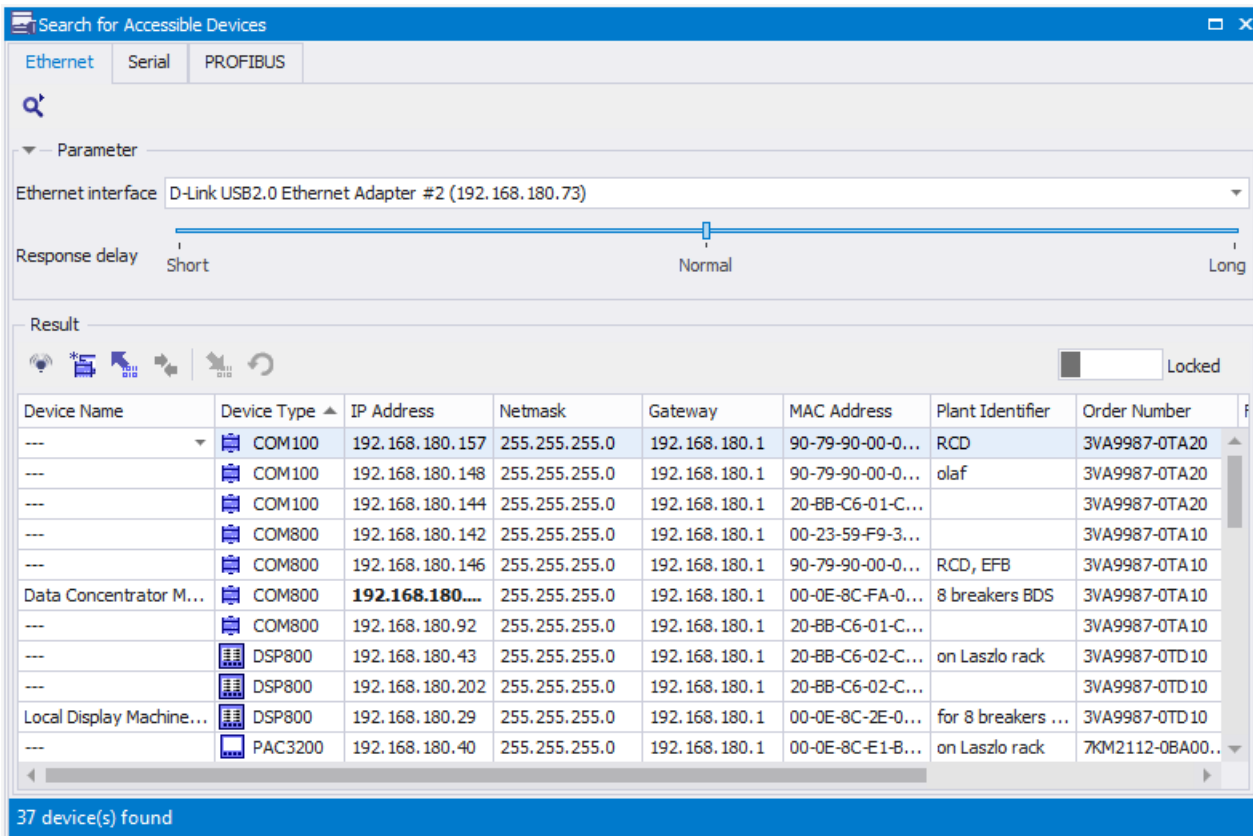

→ The COM800 / COM100 breaker data server is displayed with its MAC address and possibly an IP address, subnet mask and gateway in the dialog box.

→ Adapt the subnet mask if applicable. You will find further information under "IP addressing with fixed IP addresses (Page 239)".

→ Check accessibility with "Activate Blinking Mode" in the PC if applicable.

4. Use the function "Activate blinking mode for selected device" to initiate flashing of the LEDs on the COM800 / COM100 breaker data server so that it can be clearly identified.

If the communication partner is configured in a different IP subnet, the appropriate interface settings to allow access to this IP subnet must also have been entered, see chapter "PC network settings (Page 213)".

See also

- Operator controls and displays (Page 112)
- LED display (Page 158)
- LED display (Page 179)
- Operator controls and displays (Page 112)
- Understanding status transitions (Page 251)
- Signaling the communication capability (Page 130)
- Connecting the 3VA-line (Page 109)

8.4.2 Check communication between COM800 / COM100 breaker data server and 3VA molded case circuit breakers

If these checks do not lead to a positive result, the communication link between the COM800 / COM100 breaker data server and the connected 3VA molded case circuit breakers must be checked.

1. Check especially the "COM" and "ACT" LEDs on the COM800 / COM100ACTbreaker data server. For more details, see chapter "LED display (Page 112)".
2. Check the communication on the relevant 3VA molded case circuit breaker. For additional information on this topic, please refer to chapter "Signaling the communication capability (Page 130)".
 - Check the full and correct cabling of the 3VA-line (Page 124) if applicable.
 - Check the correct fit of all connectors of the 3VA-line
 - Check whether the terminating resistors have been correctly connected at both ends of the 3VA-line

If the ETUs and/or the COM800 / COM100 breaker data server are signaling communication faults, the relevant messages can be read out in powerconfig in order to determine the fault cause. For additional information, please refer to chapter "Understanding status transitions (Page 251)".

8.4.3 Check communication between external communication partner and 3VA

If the external communication and communication on the 3VA-line are both functioning, it is also possible that no 3VA molded case circuit breaker, or the wrong molded case circuit breaker, is addressed.

1. In the Overview, check which breakers are actually available for the COM800 / COM100 breaker data server.
2. Check that the configured breaker is also the desired breaker (flashing).
3. Check that the desired breaker is addressed in the communication partner:
 - powermanager: IP address + "Unit ID" → Set the addresses correctly.
 - SIMATIC S7: Check whether the breakers have been created as Slot 1...8 in the hardware configuration → Create the breaker and modify it accordingly. You can find more information in chapters PROFIBUS DP (Page 155) and PROFINET IO (Page 177).
 - SIMATIC-CPU via STEP 7: Search for available nodes on the networks → Correct the PROFIBUS DP or PROFINET addressing.

Given the great diversity of communication channels, not all eventualities can be described.

An effective procedure is to check and ensure the functioning of the individual communication segments step-by-step.

Appendix

A.1 Standards and specifications

A.1.1 3VA molded case circuit breaker

Description

Table A- 1 International standards to which series 3VA2 and 3VA6 molded case circuit breakers conform

		CE products	UL&CE products
IEC / EN 61000-4-2	Electrostatic discharge immunity test	✓	✓
IEC / EN 61000-4-3	Radiated, radio-frequency, electromagnetic field immunity test	✓	✓
IEC / EN 61000-4-4	Electrical fast transient/burst immunity test	✓	✓
IEC / EN 61000-4-5	Surge immunity test	✓	✓
IEC / EN 61000-4-6	Immunity to conducted disturbances, induced by radio-frequency fields	✓	✓
EN 61557-12, Class 2	Accuracy class for energy measurement	ETU series 8	ETU series 8
UL 489	Communication components for 3VA are certified according to UL 489.	---	✓

Standards with which 3VA molded case circuit breakers comply can be found at: 3VA certificates (<http://support.automation.siemens.com/WW/view/en/54137334/134200>)

A.1.2 PROFIBUS / PROFINET expansion modules

Table A- 2 PROFIBUS / PROFINET expansion modules conform to the following international standards

Standard	Title
IEC 60603-7	Connectors for electronic equipment - Part 7: Detail specification for 8-way, shielded, free and fixed connectors
IEC 61158-2:2004	"Digital data communications for measurement and control - Fieldbus for use in industrial control systems - Part 2: Physical layer specification and service definition"
IEC 61158-3:2003	"Digital data communications for measurement and control - Fieldbus for use in industrial control systems - Part 3: Data link service definition"
IEC 61158-4:2004	"Digital data communications for measurement and control - Fieldbus for use in industrial control systems - Part 4: Data link protocol specification"
IEC 61158-5:2004	"Digital data communications for measurement and control - Fieldbus for use in industrial control systems - Part 5: Application layer service definition"
IEC 61158-6:2004	"Digital data communications for measurement and control - Fieldbus for use in industrial control systems - Part 6: Application layer protocol specification"
IEC 61784-1:2004	"Digital data communications for measurement and control - Fieldbus for use in industrial control systems - Part 6: Application layer protocol specification"
IEC 61784-1:2004	PROFIBUS and PROFINET standard

A.1.3 Ethernet interface COM800 / COM100

Table A- 3 Ethernet interface COM800 / COM100

Standard	Title
Number	1
Version	RJ45 (8P8C)
Suitable cable types	100Base-TX (CAT5) Grounding of cable required
Transfer rates	10 / 100 Mbit/s Autonegotiation and Auto-MDX (Medium Dependent Interface)

A.2 List of abbreviations

AC	Alternating current
COM	3VA breaker data server
DC	Direct current
DNS	Domain Name System
DO	Draw-out unit
DSP	Display, display unit suitable for mounting in control panel
EFB	External Function Box
ETU	Electronic Trip Unit
G	Ground Fault, ground fault protection
GSD	General Station Description, description of PROFIBUS DP field devices
GSDML	General Station Description Markup Language, language for describing PROFINET IO field devices
I	Instantaneous, instantaneous short-circuit protection
I- / O-	Digital Input, digital input / Digital Output, digital output
IP	Internet protocol
L	Overload protection (L)
LI	Overload protection (L) and instantaneous short-circuit protection (I)
LIG	Overload protection (L), instantaneous short-circuit protection (I) and ground-fault protection (G)
LSI	Overload protection (L), short-time delayed short-circuit protection (S) and instantaneous short-circuit protection (I)
LSIG	Overload protection (L), short-time delayed short-circuit protection (S), instantaneous short-circuit protection (I) and ground-fault protection (G)
MAC	Media Access Control-Interface, physical access point of a device to Ethernet
MCCB	Molded Case Circuit Breaker
MDI	Medium Dependend Interface Part of transceiver of a network device
Modbus	Modicon Bus, simple communication protocol used on various transmission media
N	Neutral conductor protection
NAT	Network Address Translation, collective term for a methodology of remapping one IP address space into another by modifying network address information in Internet Protocol (IP) datagram packet headers while they are in transit across a traffic routing device.
PG	Programming device
PI	PROFIBUS and PROFINET International, PROFIBUS User Organization
RCD	Residual Current Device
RS 485	Differential, serial data transfer
RTU	Remote Terminal Unit, remote (communication) terminal unit
S	Short Time Delay, delayed short-circuit protection
SEO	Stored Energy Operator, synchronizable motor operator

SNTP	Simple Network Time Protocol
TCP	Transmission Control Protocol
TD500	Test-Device 500, test device
THD	Total Harmonic Distortion
ZSI	Zone-selective interlocking

Measured variables

$E_{a_{imp}}$	Imported active energy
$E_{a_{exp}}$	Exported active energy
$E_{r_{imp}}$	Imported reactive energy
$E_{r_{exp}}$	Exported reactive energy
E_{ap}	Apparent energy
I_{L1}, I_{L2}, I_{L3}	Phase currents
I_N	Neutral conductor current
I_G	Ground fault current
I_{L123}	Maximum phase current in phases L1, L2, L3
$I_{L_{AVG}}$	3-phase average current
I_{nba}	Current unbalance
$I_{L123max}$	Highest phase current
$LF_{L1}, LF_{L2}, LF_{L3}$	Power factor in phases L1, L2, L3
$U_{L1-N} \dots$	Value of voltage between phase L1 and the neutral conductor
P_{L1}, P_{L2}, P_{L3}	Active power in phases L1, L2, L3
$I_{\theta L123}$	Average current
Q_{tot}	Total reactive power
S_{L1}, S_{L2}, S_{L3}	Apparent power in phases L1, L2, L3
S_{tot}	Apparent power
$U_{L12} \dots$	Voltage
U_{Ln}, U_{Ln-N}	Average voltage
$U_{nb} \dots$	Voltage unbalance

A.3 Comprehensive support from A to Z

A.3.1 Comprehensive support from A to Z

For more information, please see the following links:

Useful links

Table A- 4 Product information

Website	The website provides rapid and targeted information on our pioneering products and systems.	Link (http://www.siemens.com/lowvoltage)
Newsletter	Constantly updated information on the subject of low-voltage power distribution.	Link (http://www.siemens.com/lowvoltage/newsletter)

Table A- 5 Product information / product and system selection

Information and Download Center	<ul style="list-style-type: none"> • Current catalogs • Customer magazines • Brochures • Demonstration software • Promotion packages 	Link (http://www.siemens.com/lowvoltage/infomaterial)
--	---	--

Table A- 6 Product and system selection

Industry Mall	<p>Platform for e-business and product information. 24/7 access to a comprehensive information and ordering platform for our complete low-voltage controls and distribution portfolio, including:</p> <ul style="list-style-type: none"> • Selection tools • Product and system configurators • Availability check • Order tracking 	Link (http://www.siemens.com/lowvoltage/mall)
----------------------	---	--

Table A-7 Product documentation

Service & Support Portal	<p>Comprehensive technical information from the planning phase through configuration to operation. Around the clock. 365 days a year.</p> <ul style="list-style-type: none"> • Product data sheets • Manuals / operating instructions • Certificates • Characteristic curves • Downloads • FAQs 	Link (http://www.siemens.com/lowvoltage/support)
CAX DVD	<p>Configuration-relevant CAX data on SENTRON is available on DVD:</p> <ul style="list-style-type: none"> • Commercial and technical product master data • 2D dimension drawings • Isometric illustrations • 3D models • Product data sheets • Tender specifications 	Link (http://www.siemens.com/lowvoltage/mall) Order number: E86060-D1000-A207-A6-6300
Image Database	<p>Free downloads in several different versions are available from the image database:</p> <ul style="list-style-type: none"> • All current product photos • 2D dimension drawings • Isometric illustrations • 3D models • Device circuit diagrams • Symbols 	Link (http://www.siemens.com/lowvoltage/picturedb)

Table A-8 Product training

SITRAIN Portal	Comprehensive training program to expand your knowledge about our products, systems, and engineering tools	Link (http://www.siemens.com/lowvoltage/training)
-----------------------	--	--

A.4 References

A.4.1 References

Profiles for Low Voltage Switchgear Devices (LVSG) Technical Specification for PROFINET IO and PROFIBUS

Version 1.32 - Date January 2013 Order No.: 3.122

Common Application Profile PROFlenergy

Version 1.1 (Technical Specification for PROFINET Version 1.1 – Date: August 2012 Order No.: 3.802).

MODBUS over Serial Line Protocol and Implementation Guide V1.02

www.modbus.org

Glossary

100BaseT

Fast Ethernet standard (100 Mbit/s) for data transmission on twisted-pair cables.

10BaseT

Standard for the transmission of 10 Mbit/s Ethernet on twisted-pair cables.

Active RS 485 terminating element

Independent terminating resistor for bus segments with transmission rates of between 9.6 kbit/s and 12 Mbit/s. The resistor is supplied with power independently of the bus nodes.

AUTO

Method of remote operation of the motor operators via control cables, e.g. PLC.

Autonegotiation

Ability of a device to automatically detect the fastest possible transmission rate, and to send and receive at this rate.

AWG

American Wire Gauge (AWG) is a specification for wire diameters that is mainly used in North America.

Baud rate

See transmission rate

Breaking capacity

The rated ultimate short-circuit breaking capacity I_{cu} is the maximum value of the short-circuit current which the protective device is capable of disconnecting in accordance with regulations. Up to this value, the protective device is also allowed to be used in a network.

Bus

Communication system to which all nodes are connected and which has two defined ends. In the case of Profibus, the bus is a two-wire line (copper cable) or a fiber optic conductor.

Bus connector

Physical connection between a node and the bus cable.

Bus segment (Profibus DP)

Each bus segment has a minimum of two nodes, at least one of which is the DP master.

Bus system

All nodes physically connected to a bus cable form a bus system.

Configuring

The configuring process involves the input of device-specific parameters using, for example, STEP 7 or powerconfig.

Demand period

Period to which the calculation of the power demand refers. A demand period is typically 15, 30, or 60 minutes long.

A distinction is made between the actual period and the instantaneous period. The actual period is the last completed period. The instantaneous period is the period still in progress and has not yet been completed.

DIN rail

Metal rail of a standard type compliant with EN 50 022.

Network components such as OLMs, repeaters, etc. are snap-mounted on DIN rails.

DP master

Within the DP system, the DP master conducts communication with the DP slaves in accordance with a defined algorithm. For this purpose, the DP master employs the functions defined for PROFIBUS-DP in order to communicate with the DP slaves.

DP slave

The DP slave can be addressed by DP masters. The DP slave makes specified functions (I/O data, diagnostics, etc.) available to DP masters.

Equipotential bonding

Electrical connection (equipotential bonding conductor) which brings the exposed conductive parts of electronic equipment and external conductive parts to an equal or approximately equal potential. This prevents disruptive or dangerous voltages between these conductive parts.

Ethernet switch

An Ethernet switch connects network segments within an Ethernet network. The Ethernet switch ensures that data are transferred directly to their destination. For this purpose, the Ethernet switch accesses the hardware addresses of the connected devices.

Firmware

Device operating software. The firmware is stored in the device's electronic components.

 I^2t characteristic

The I^2t characteristic is a curve which represents the minimum or maximum values of I^2t in relation to breaking times as a function of the prospective current under defined operating conditions.

 I^2t value

The I^2t value is the thermal value of a prospective or a limited short-circuit current (let-through current).

IP address value range

The IP address comprises 4 decimal numbers ranging from 0 to 255 that are separated by a dot, e.g. 141.80.0.16

Let-through current

The let-through current I_b is the maximum instantaneous current value during the breaking time of a switching device or fuse. Limited short-circuit currents occur if the switching device reduces the amplitude of the short-circuit current due to, for example, resistance, switching delay and peak arc voltage. The let-through current of a device such as a current-limiting fuse or a current-limiting molded case circuit breaker determines the thermal load (I^2t value) imposed on equipment connected downstream of the device (current limiting).

Load profile memory

Device data memory for storing performance data, including associated identifying characteristics such as a time stamp.

LOCK

Local, manual operating mode of motor operators.

MAC address

MAC addresses are hardware addresses for identifying network nodes. A MAC address comprises six bytes in hexadecimal notation that are separated by hyphens.

Making capacity

The making capacity is the value of the prospective making current which the switching device can conduct at the instant of closing under prescribed conditions for a specific circuit.

For molded case circuit breakers, the making capacity is expressed as the maximum possible instantaneous value of the potential prospective current at the input terminals for the specified voltage.

MANUAL

Local, manual operating mode of motor operators.

Master

When a master is in possession of the token, it is permitted to send data to other nodes or to request data from them (= active node).

Master-slave principle

Bus accessing principle with which only one node at a time is the master and all other nodes are slaves.

MDI-X auto crossover

Ability of the interface to detect the send and receive lines of the connected device autonomously and adjust to them. This prevents malfunctions resulting from mismatching send and receive lines. Both crossed and uncrossed cables can be used.

Node

Device which can send and/or receive data on the bus, e.g., a DP master or a DP slave. For this purpose, the node must have a unique PROFIBUS address.

PROFIBUS

PROcess Field BUS, a bit-serial fieldbus system standardized in IEC 61158-2 as "type 3". This standard prescribes functional, electrical and mechanical properties.

PROFIBUS is a bus system that networks PROFIBUS-compatible automation systems and field devices at the cell and field level. PROFIBUS is compatible with protocols such as DP (= decentralized peripherals), FMS (= fieldbus message specification) or PA (process automation).

PROFIBUS address

Each bus node must have a unique PROFIBUS address.

PCs and programming devices have PROFIBUS address "0".

DP masters and DP slaves use a PROFIBUS address between 1 and 125.

PROFIBUS DP

PROFIBUS bus system with the DP protocol. DP stands for the German equivalent of distributed I/O. The main task of PROFIBUS DP is to manage the fast, cyclic data exchange between the central DP master and the I/O devices.

PROFINET

PROFINET (Process Field Network) is the open Industrial Ethernet standard developed by Profibus & Profinet International (PI) for automation applications. Profinet utilizes TCP/IP and IT standards, is real-time Ethernet-capable and supports the integration of fieldbus systems.

Protective characteristic

The protective characteristic is determined by the rated operational current and the setting and tripping values of the circuit breaker.

Rated breaking capacity

The rated breaking capacity is the maximum current that can be interrupted by a switching device under certain conditions.

Rated frequency

Design frequency for a switching device and reference value for other characteristics of the device.

Rated making capacity

The rated making capacity is the maximum current that a switching device can conduct at the instant of closing in accordance with the utilization category at the relevant rated operational voltage.

Rated operational voltage

The rated operational voltage U_e of a switching device, e.g. a molded case circuit breaker, is the voltage which serves as a reference to state other characteristics of the device. The maximum rated operational voltage must never be higher than the rated insulation voltage.

With multi-phase circuits, the specified voltage is generally the phase-to-phase voltage.

Rated residual current

The rated residual current $I_{\Delta n}$ is the fault (residual) current for which residual current-operated circuit breakers are designed. The residual current rating is declared on the rating plate of the device.

Rated service short-circuit breaking capacity

The rated service short-circuit breaking capacity I_{cs} is the short-circuit current determined by the operational voltage that a molded case circuit breaker is capable of interrupting repeatedly (test sequence 0 - C0 - CO, formerly P - 2). After a molded case circuit breaker has interrupted a short circuit, it can continue to carry the rated operational current despite increased self-heating and will trip again in the event of a short circuit.

Rated short-time current

Permissible rms value of the AC component of the prospective short-circuit current which the switching device is capable of conducting for a specific time period, e.g. from 0.05 s to 1 s (thermal short-circuit strength).

Rated uninterrupted current

The rated uninterrupted current I_U of a switching device, e.g. a molded case circuit breaker, is a current that the device can conduct in uninterrupted operation (for weeks, months or years). This current is specified by the manufacturer.

Rating

The rating is the power that a switching device is capable of switching at the associated rated operational voltage in accordance with the utilization category, e.g. power contactor utilization category AC-3:37 kW at 400 V.

Reference potential

Potential is the reference point of the relevant circuits from which voltages are calculated and/or measured.

Relationship between IP address and gateway address

The IP address and the gateway address may differ only in the positions that are set to "0" in the subnet mask.

Example:

You have entered: 255.255.255.0 for the subnet mask; 141.30.0.5 for the IP address and 141.30.128.254 for the gateway address. In this example, the IP address and the gateway address must be identical except for the value of the 4th decimal number. But in this example, the 3rd decimal number is also different.

For this example, therefore, you must make one of the following changes:

Change the subnet mask to: 255.255.0.0 or

the IP address to: 141.30.128.5 or

the gateway address to: 141.30.0.254

Relationship between IP address and subnet mask

The first decimal number of the IP address (from the left) determines the structure of the subnet mask with respect to the number of "1" values (binary) as shown below ("x" is the host address):

First decimal number of IP address Subnet mask

0 to 127 255.x.x.x

128 to 191 255.255.x.x

192 to 223 255.255.255.x

Note:

You can also enter a value between 224 and 255 as the first decimal number of the IP address. This is not recommended, however, because this address range is reserved for other functions and some configuration tools (such as STEP 7) do not check values in this range.

Remote control

Or AUTO; method of remote operation of the motor operators via control cables, e.g. PLC.

RJ45

Symmetrical connector for data lines that is also known as a Western connector or a Western plug. This is a widely used plug connector in telephone and ISDN technology which is used in LAN installations in the office environment.

RMS

The root mean square of a signal which varies over time, e.g. of the oscillation of a voltage or current in power supply systems.

RS 485

Asynchronous data transmission procedure for PROFIBUS DP in accordance with ANSI TIA/EIA-RS485-A.

RS 485 repeater

Device for amplifying bus signals and for linking bus segments over large distances.

Segment

The bus cable between two terminating resistors forms a segment.

Up to 32 bus nodes can be connected to a single segment. RS 485 repeaters or diagnostic repeaters, for example, can be used to link segments.

Short circuit

Connection with a negligibly low impedance between two points of different potential in an electric circuit. The short-circuit current is a multiple of the rated operating current. Short circuits can cause thermal or mechanical damage to switching devices and other parts of an electrical installation.

Short-circuit strength

This is the resistivity of a switching device in the closed state, along with its components (e.g. releases), or a complete switchgear, to the electrodynamic and thermal stresses which arise in the event of a short circuit.

The characteristic for the dynamic stress is the rated peak withstand current, which is the maximum instantaneous value of the short-circuit current.

The characteristic for the thermal stress of the short-circuit current is the root-mean-square value of the short-circuit current throughout its duration.

Slave

A slave can only exchange data after being requested to by the master.

All DP slaves such as ET 200S, ET 200X, ET 200M etc. are typical examples of slaves.

Subnet mask value range

The subnet mask comprises 4 decimal numbers ranging from 0 to 255 that are separated by a dot, e.g. 255.255.0.0

The 4 decimal numbers of the subnet mask in their binary representation must comprise a contiguous sequence of "1" values on the left and a contiguous sequence of "0" values on the right.

The "1" values determine the network number within the IP address. The "0" values are the host address within the IP address.

Example:

Correct values:

255.255.0.0 decimal = 11111111.11111111.00000000.00000000 binary

255.255.128.0 decimal = 11111111.11111111.10000000.00000000 binary

255.254.0.0 decimal = 11111111.11111110.00000000.00000000 binary

Incorrect value:

255.255.1.0 decimal = 11111111.11111111.00000001.00000000 binary

TCP/IP

Transport Control Protocol / Internet Protocol, the de-facto standard; protocol for worldwide communication over Ethernet.

Terminator

Terminating resistor for bus segments with transmission rates of between 9.6 kbit/s and 12 Mbit/s. The resistor is supplied with power independently of the bus nodes.

Transmission rate

This states the rate of transmission of bits per second. PROFIBUS is capable of transmission rates of between 9.6 kbit/s and 12 Mbit/s.

Tripping current of overload release

The current value at which a trip unit trips within a specified time.

Tripping current, ground fault

When the ground fault current reaches or exceeds this limit value, the ground-fault release, for example, of a molded case circuit breaker, is tripped.

Tripping current, instantaneous

When this current limit is exceeded, the circuit breaker trips instantaneously.

Tripping current, overload

When this uninterrupted current limit is exceeded within a predefined time period, the circuit breaker trips (inverse-time delayed tripping!).

Tripping current, short-time delayed

When this current limit is exceeded, the circuit breaker trips after a predefined time delay.

Tripping time

Period of time from the instant of commencement of trip command output to the moment at which the command becomes irrevocable (timing concept for the tripping of circuit breakers).

Twisted-pair

Data cable with twisted-wire pairs; the twist in the wire pairs provides good transmission properties and prevents electromagnetic interference. Twisted-pair cables are available in different qualities for different transmission rates.

Value range for gateway address

The address comprises 4 decimal numbers ranging from 0 to 255 that are separated by a dot, e.g. 141.80.0.1

Index

3

- 3VA connection options, 22
- 3VA molded case circuit breaker
 - Components, 20
 - Draw-out technology, 50
 - Information accompanying breaker status, 46
 - Measured variables, 52
 - Parameterizing, 42
 - Possible applications, 94
 - Replacing, 247
 - Switching state, 44
- 3VA molded case circuit breaker
 - Switching states, 45

7

- 7KM PAC PROFIBUS DP expansion module, 32
 - Address, 160
 - LED display, 158
- 7KM PAC Switched Ethernet PROFINET expansion module, 34, 177
- 7KM PAC Switched Ethernet PROFINET expansion module, 34, 177
- 7KM PAC Switched Ethernet PROFINET expansion module
 - LED display, 179
- 7KM PAC Switched Ethernet PROFINET expansion module
 - First commissioning, 180

A

- Ambient conditions, 105
- Applications, 91

C

- COM060 communication module, 124
- COM800 / COM100 breaker data server, 22, 107
 - First commissioning, 115
 - LED display, 112
 - Operator controls, 112
 - Write protection, 114
- COM800 / COM100 breaker data server, 22, 107

- COM800 / COM100 breaker data server
 - Device library, 116
- COM800 / COM100 breaker data server
 - Time synchronization, 117
- Communication
 - acyclic, 170
 - cyclic, via PROFIBUS DP, 164
 - Cyclically, via PROFINET IO, 186
- Communication faults, 253
- Communication functions, 41

D

- DSP800 display, 28
 - Area of application, 28
 - Features, 29
 - LC display, 142
 - Operator controls, 141
 - powerconfig, 145

E

- EFB300
 - Connection, 132
 - First commissioning, 135
- EFB300 external function box, 27
 - Operator controls, 134
- ETU
 - Area of application, 25
 - Features, 26
 - Protection functions, 25

F

- Firewall rules, 213
- Firmware update, 245

G

- GSD file, 161
 - Naming convention, 162
- GSDML file, 182

I

- Installation locations, 101

M

- Maintenance
 - Information, 94
- Measured variables, 52
 - Current variables, 54
 - Distortion, 68
 - Energy flow, 66
 - Frequency, 68
 - Power demand, 59
- Messages, 72
- Modbus TCP, 206

N

- Network planning, 106

O

- Open Source Software, 16
 - Use, 16
- Operational messages, 72
- Operator action messages, 72

P

- Parameterizing, 42
- Power monitoring, 44
- powerconfig, 211
 - Delivery, 212
 - Features, 39
 - Functions, 38
 - System requirements, 212
 - User interface, 217
- powermanager, 95
 - Application, 96
- PROFIBUS DP, 164
 - Communication, 99
- PROFenergy, 98, 192
- PROFINET, (see also 7KM PAC Switched Ethernet PROFINET), 181
- PROFINET IO, 185

S

- Safety-relevant information, 15
- Supply voltage, 104
- System messages, 72

T

- TD500 test device, 30
 - Features, 31
 - LED displays, 152
 - Operator controls, 150
- Tripping characteristic, 42
- Tripping functions, 31

V

- Voltage variables, 56

Further Information

Always at your disposal: our extensive support
www.siemens.com/online-support

Siemens AG
Energy Management
Low Voltage & Products
Postfach 10 09 53
93009 REGENSBURG
Germany

Subject to change.
3ZW1012-0VA20-0BC0
© Siemens AG 2014

EM LP
Online

