

# SIEMENS

## SITOP power supply

## SITOP modular 1ph/2ph

### Operating Instructions

SITOP PSU200M 24 V/5 A  
6EP1333-3BA10  
SITOP PSU200M 24 V/10 A  
6EP1334-3BA10  
SITOP modular 24 V/20 A  
6EP1336-3BA00  
SITOP PSU100M 24 V/40 A  
6EP1337-3BA00

06.2014

C98130-A7548-A1-3-7629

### Overview



---

Safety instructions	1
Description, device design, dimension drawing	2
Mounting/removal	3
Mounting position, mounting clearances	4
Installation	5
Technical data	6
Safety, approvals, EMC	7
Ambient conditions	8
Applications	9
Environment	10
Service & Support	11

## Legal information

### Warning notice system

This manual contains notices you have to observe in order to ensure your personal safety, as well as to prevent damage to property. The notices referring to your personal safety are highlighted in the manual by a safety alert symbol, notices referring only to property damage have no safety alert symbol. These notices shown below are graded according to the degree of danger.

 <b>DANGER</b>
indicates that death or severe personal injury <b>will</b> result if proper precautions are not taken.
 <b>WARNING</b>
indicates that death or severe personal injury <b>may</b> result if proper precautions are not taken.
 <b>CAUTION</b>
indicates that minor personal injury can result if proper precautions are not taken.
<b>NOTICE</b>
indicates that property damage can result if proper precautions are not taken.

If more than one degree of danger is present, the warning notice representing the highest degree of danger will be used. A notice warning of injury to persons with a safety alert symbol may also include a warning relating to property damage.

### Qualified Personnel

The product/system described in this documentation may be operated only by **personnel qualified** for the specific task in accordance with the relevant documentation, in particular its warning notices and safety instructions. Qualified personnel are those who, based on their training and experience, are capable of identifying risks and avoiding potential hazards when working with these products/systems.

### Proper use of Siemens products

Note the following:

 <b>WARNING</b>
Siemens products may only be used for the applications described in the catalog and in the relevant technical documentation. If products and components from other manufacturers are used, these must be recommended or approved by Siemens. Proper transport, storage, installation, assembly, commissioning, operation and maintenance are required to ensure that the products operate safely and without any problems. The permissible ambient conditions must be complied with. The information in the relevant documentation must be observed.

### Trademarks

All names identified by ® are registered trademarks of Siemens AG. The remaining trademarks in this publication may be trademarks whose use by third parties for their own purposes could violate the rights of the owner.

### Disclaimer of Liability

We have reviewed the contents of this publication to ensure consistency with the hardware and software described. Since variance cannot be precluded entirely, we cannot guarantee full consistency. However, the information in this publication is reviewed regularly and any necessary corrections are included in subsequent editions.

# Overview



The 1-phase/2-phase power supply from the SITOP modular product line is a powerful, stabilized technology power supply for automated machines and systems.

The key benefits of the product include:

- Wide-range input, which allows it to be connected to almost any 1-phase/2-phase line supply around the world
- Output voltage can be adjusted in the range 24...28.8 V
- Power boost during operation with 300% rated current for 25 ms
- No lateral mounting clearances are required
- Ambient temperature -25 (0)...+70° C
- Selectable short-circuit response (constant current or latching shutdown)
- A soft characteristic can be selected for a parallel connection (for uniform load distribution of power supply units of the same type)
- Display of the operating state via 3 LEDs
- To increase the system availability, these reliable power supplies can be expanded using SITOP supplementary modules (redundancy module, selectivity module, buffer module, signaling module or signaling contact), as well as SITOP DC-UPS modules.

## Ordering data

The following device options are available:

Stabilized power supply unit SITOP modular 1ph/2ph	
Type	Order number
120-230/230-500 VAC input, 24 V/5 A output	6EP1333-3BA10
120-230/230-500 VAC input, 24 V/10 A output	6EP1334-3BA10
120/230 VAC input, 24 V/20 A output	6EP1336-3BA00
120/230 VAC input, 24 V /40 A output	6EP1337-3BA00

# Table of contents

	<b>Overview.....</b>	<b>3</b>
<b>1</b>	<b>Safety instructions.....</b>	<b>7</b>
<b>2</b>	<b>Description, device design, dimension drawing.....</b>	<b>9</b>
2.1	Device description.....	9
2.2	Connections and terminal designation.....	10
2.3	Potentiometer.....	12
2.4	Status displays and signaling.....	13
2.5	Change-over switch.....	14
2.6	Block diagram.....	16
2.7	Dimensions and weight.....	18
<b>3</b>	<b>Mounting/removal.....</b>	<b>21</b>
<b>4</b>	<b>Mounting position, mounting clearances.....</b>	<b>23</b>
4.1	Standard mounting position.....	23
4.2	Other mounting positions.....	25
4.2.1	6EP1333-3BA10.....	25
4.2.2	6EP1334-3BA10.....	27
4.2.3	6EP1336-3BA00.....	29
4.2.4	6EP1337-3BA00.....	31
<b>5</b>	<b>Installation.....</b>	<b>33</b>
5.1	Line-side connection.....	33
5.2	Output-side connection.....	36
<b>6</b>	<b>Technical data.....</b>	<b>37</b>
6.1	Input.....	37
6.2	Output.....	39
6.3	Efficiency.....	46
6.4	Closed-loop control.....	48
6.5	Protection and monitoring.....	48
6.6	MTBF.....	48
6.7	Mechanical system.....	49
6.8	Accessories.....	49
6.9	Dimension drawing.....	50

<b>7</b>	<b>Safety, approvals, EMC .....</b>	<b>51</b>
7.1	Safety .....	51
7.2	Test voltage.....	52
7.3	Approvals .....	54
7.4	EMC .....	54
<b>8</b>	<b>Ambient conditions.....</b>	<b>55</b>
<b>9</b>	<b>Applications .....</b>	<b>57</b>
9.1	Parallel connection to increase power rating .....	57
9.2	Parallel connection for redundancy.....	59
9.3	Series connection for increased voltage .....	61
9.4	Overload protection in the 24 V output circuit .....	62
9.5	Protection against short-time voltage dips .....	63
9.6	Protecting against longer power failures.....	64
<b>10</b>	<b>Environment .....</b>	<b>67</b>
<b>11</b>	<b>Service &amp; Support.....</b>	<b>69</b>

# Safety instructions

# 1

 **WARNING**

**Correct handling of the devices**

When operating electrical devices, it is inevitable that certain components will carry dangerous voltages.

Therefore, failure to handle the units properly can result in death or serious physical injury as well as extensive property damage.

Only appropriately qualified personnel may work on or in the vicinity of this equipment.

Perfect, safe, and reliable operation of this equipment is dependent on proper transportation, storage, installation and mounting.

Before installation or maintenance work can begin, the system's main switch must be switched off and measures taken to prevent it being switched on again.

If this instruction is not observed, touching live parts can result in death or serious injury.





# Description, device design, dimension drawing

# 2

## 2.1 Device description

SITOP modular is a primary-clocked power supply for connection to a 1-phase/2-phase AC line supply. An electronically regulated DC voltage that can be set via a potentiometer is available at the output of the device. The output of the device is isolated, no-load proof and short-circuit proof. The LED displays indicate the operating state. The integrated signaling contact (for 6EP1336-3BA00 and 6EP1337-3BA00, only when using the supplementary 6EP1961-3BA10 signaling module) can be used to further process the operating state of the device.

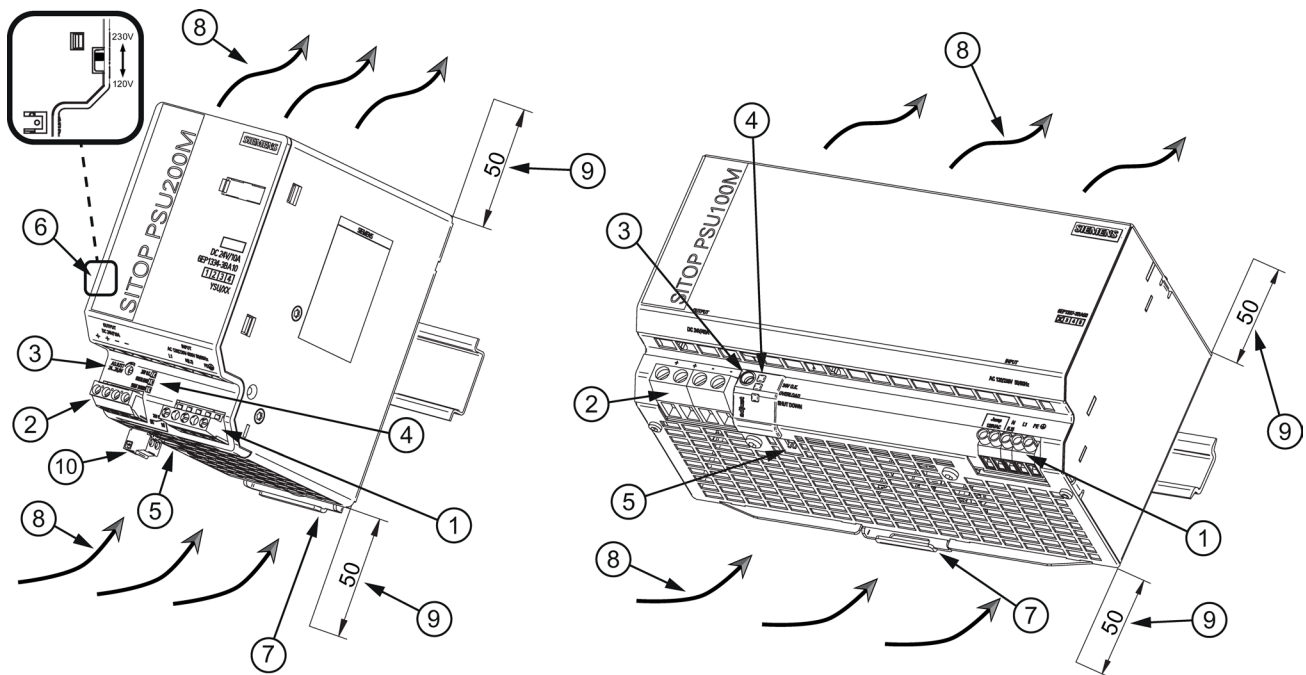



- ① Line input
- ② DC output
- ③ Potentiometer 24...28.8 V
- ④ Pilot lamps (24 V OK, OVERLOAD, SHUTDOWN)
- ⑤ A/B selector switch
- ⑥ Voltage selector switch (only for 6EP1333-3BA10 and 6EP1334-3BA10)
- ⑦ DIN rail slider
- ⑧ Natural convection
- ⑨ Clearance above/below
- ⑩ Signaling contact (only for 6EP1333-3BA10 and 6EP1334-3BA10)

Figure 2-1 Design (example, 6EP1334-3BA10 and 6P1337-3BA00)

## 2.2 Connections and terminal designation

The line input terminals ① can be used to establish the connection to the supply voltage. The output terminals ② are used to connect to the loads to be supplied (see also Section Installation (Page 33)).



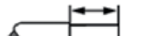

Connections and terminal designations for 6EP1333-3BA10 and 6EP1334-3BA10	
① Line input L1, N (L2), PE	One screw terminal each
② Output +	2 screw terminals
② Output -	2 screw terminals
⑩ Signaling contact 13, 14	One screw terminal each

	①	②	⑩	④
	SZS 0,6 x 3,5 / PZ1 / PH1	SZS 0,6 x 3,5 / PZ1 / PH1	SZS 0,6 x 3,5	SZS 0,4 x 2,5 / max. Ø 3,5 mm
	1 x 0,05 - 4 mm <sup>2</sup>	1 x 0,2 - 4 mm <sup>2</sup>	1 x 0,14 - 1,5 mm <sup>2</sup>	-
	1 x 0,05 - 4 mm <sup>2</sup>	1 x 0,2 - 2,5 mm <sup>2</sup>	1 x 0,14 - 1,5 mm <sup>2</sup>	-
AWG	30 - 11	24 - 12	28 - 16	-
Nm	0,5 Nm	0,5 - 0,6 Nm	0,22 Nm	0,04 Nm <sup>**1)</sup>
	6,5 - 7 mm	8 mm	7 mm	-

<sup>\*\*1)</sup>Do not subject the end stop to higher loads



Figure 2-2 Terminal data for 6EP1333-3BA10 and 6EP1334-3BA10

Connections and terminal designations for 6EP1336-3BA00 and 6EP1337-3BA00	
① Line input L1, N (L2), PE, Jump 120 V AC	One screw terminal each
② Output +	2 screw terminals
② Output -	2 screw terminals

	①	②	④
	SZS 0,6 x 3,5 / PZ1 / PH1	SZS 0,6 x 3,5 / PZ1 / PH1	SZS 0,6 x 3,5 / PZ1 / PH1 max. Ø 3,5 mm
	1 x 0,2 - 6 mm <sup>2</sup>	1 x 0,2 - 6 mm <sup>2</sup>	-
	1 x 0,2 - 4 mm <sup>2</sup>	1 x 0,2 - 4 mm <sup>2</sup>	-
AWG	24 - 10	24 - 10	-
Nm	0,5 - 0,6 Nm	0,5 - 0,6 Nm	0,04 Nm <sup>*)</sup>
	8 mm	8 mm	-

<sup>\*)</sup> Do not subject the end stop to higher loads

Figure 2-3 Terminal data for 6EP1336-3BA00

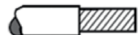
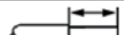
	①	②	④
	SZS 0,6 x 3,5 / PZ1 / PH1	SZS 0,6 x 3,5	SZS 0,6 x 3,5 / PZ1 / PH1 max. Ø 3,5 mm
	1 x 0,2 - 6 mm <sup>2</sup>	1 x 0,5 - 16 mm <sup>2</sup>	-
	1 x 0,2 - 4 mm <sup>2</sup>	1 x 0,5 - 10 mm <sup>2</sup>	-
AWG	24 - 10	22 - 8	-
Nm	0,5 - 0,6 Nm	1,2 Nm	0,04 Nm <sup>*)</sup>
	8 mm	12 mm	-

<sup>\*)</sup> Do not subject the end stop to higher loads

Figure 2-4 Terminal data for 6EP1337-3BA00

## 2.3 Potentiometer

The potentiometer ③ on the front of the device is used to set the output voltage. The output voltage is set to 24 V in the factory and can be adjusted in the range 24...28.8 V; for example, to compensate voltage drops across long supply lines to the connected load.

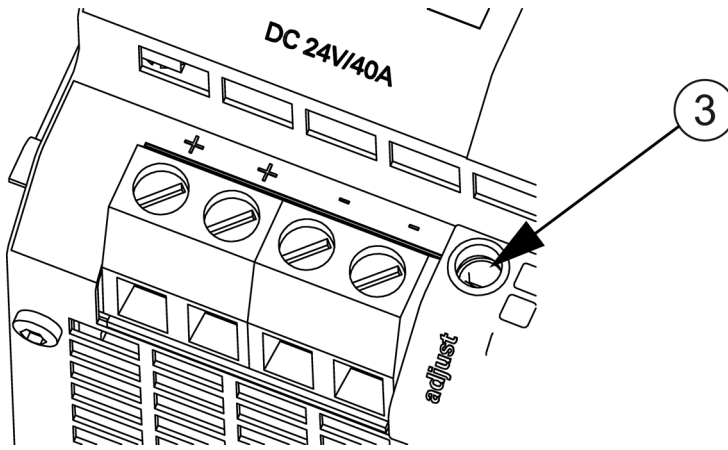

Figure 2-5 Potentiometer (example of 6EP1337-3BA00)

### NOTICE

#### Thermal overload possible

When adjusting the output voltage to  $>24$  V, the output current must be derated by 4 %/V, or the permissible ambient temperature must be taken into account with 3° C/V.

### Note

It is only permissible to use an insulated screwdriver when actuating the potentiometer.

For notes on actuating the potentiometer (screwdriver, torque), see Figure 2-2 Terminal data for 6EP1333-3BA10 and 6EP1334-3BA10 (Page 10), Figure 2-3 Terminal data for 6EP1336-3BA00 (Page 11) and Figure 2-4 Terminal data for 6EP1337-3BA00 (Page 11).

## 2.4 Status displays and signaling

	6EP1333-3BA10 (24 V/5 A) 6EP1334-3BA10 (24 V/10 A) 6EP1336-3BA00 (24 V/20 A) 6EP1337-3BA00 (24 V/40 A)
Status indicator	Green LED for 24 V O.K. Yellow LED for overload in "constant current" mode Red LED for latching shutdown in "shut down" mode

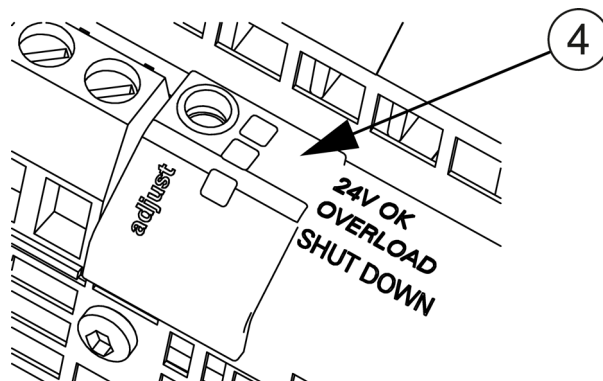

Figure 2-6 Status indicators and signals (example of 6EP1337-3BA00)

<b>Signaling</b>	6EP1333-3BA10 (24 V/5 A) 6EP1334-3BA10 (24 V/10 A) 6EP1336-3BA00 (24 V/20 A) 6EP1337-3BA00 (24 V/40 A)
Green LED ④ lights up	Normal operation, output voltage $>20\text{ V} \pm 0.5\text{ V}$
Yellow LED ④ lights up	Overload ( $U_a < 20\text{ V} \pm 0.5\text{ V}$ )
Red LED ④ lights up	Latching shutdown or remote switch-off for 6EP1336-3BA00 and 6EP1337-3BA00 (only when the supplementary signaling module 6EP1961-3BA10 is used)
Green LED ④ off	No supply voltage

## 2.5 Change-over switch

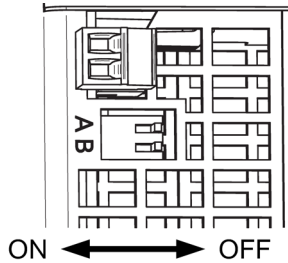

Figure 2-7 A/B selector switch

The two switches A and B are used to influence the output characteristic curve:

Switch	ON	OFF
<b>A</b> influences the output characteristic in the load range	<b>Parallel operation:</b> 'Soft' characteristic curve (see, e.g. Figure 6-10 6EP1333-3BA10 parallel operation output characteristic (Page 43)) for the parallel operation of two or more devices: The output voltage falls with increasing output current (namely, also for the overcurrent pulse!). This means that for full output current the highest output voltage can normally no longer be attained.	<b>Single operation:</b> <i>Delivery state</i>  'Hard' characteristic curve (see, e.g. Figure 6-3 6EP1333-3BA10 single operation output characteristic (Page 41)) for normal operation (single operation): The output voltage is independent of the output current.
<b>B</b> influences the output characteristic in the overload range	<b>Latching shutdown:</b> If the output current rises above the rated value and above the current limit, the device reduces the output voltage (see, e.g. Figure 6-14 6EP1333-3BA10 latching shutdown output characteristic (Page 44)). If the output voltage falls below 20 V, the device shuts down latching, the red LED lights up. This limit voltage of 20 V is independent of the set output voltage. The 'Short-time overload current' feature is not available in this operating mode. To also permit the uploading of large capacitances in this operating mode at the output, a shutdown is performed during the first 10 s after power on or remote on in conjunction with the non-latching signaling module. During these first 10 s, the device responds for overload as if the switch is OFF.	<b>Constant current:</b> <i>Delivery state</i>  If the output current rises above the rated value and above the current limit, the device reduces the output voltage. The yellow LED lights up if the output voltage falls below 20 V.

Delivery state: A - OFF; B - OFF

Selector switch for the input voltage range for 6EP1333-3BA10 (24 V/5 A) and 6EP1334-3BA10 (24 V/10 A)

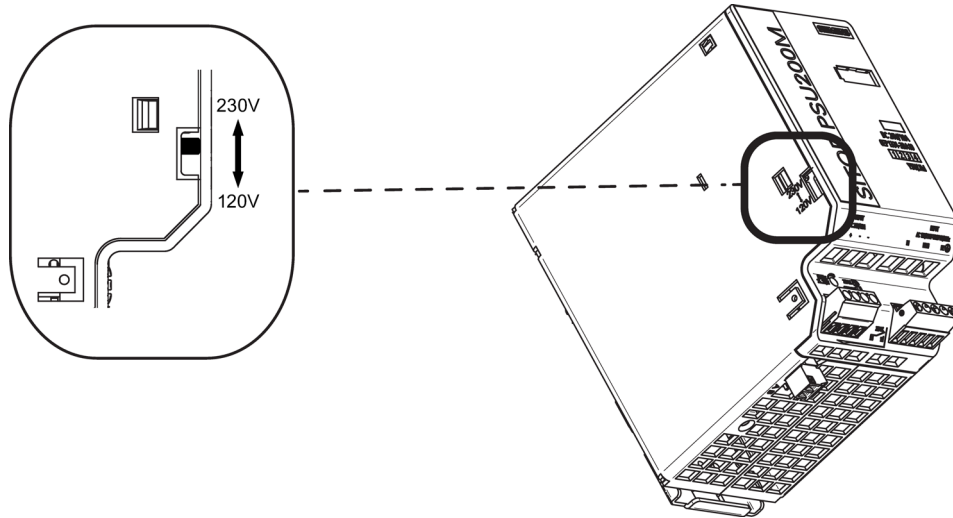

Figure 2-8 Voltage selector switch (example, 6EP1334-3BA10)

The selector switch as delivered is in the 230 V position. It must be moved to the appropriate position for operation in the 120 V range. The selector switch can only be actuated in the de-energized state.

To switch the input voltage range for 6EP1336-3BA00 (24 V/20 A) and 6EP1337-3BA00 (24 V/40 A) to 120 V, a wire jumper must be connected to the input terminal, Jump 120 V AC. This must be dimensioned as for the power supply cable with regard to cross-section and insulation. The length must not exceed 100 mm.

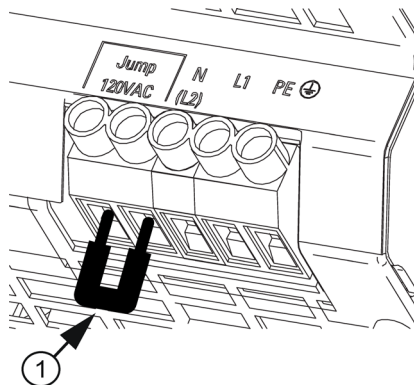

Figure 2-9 Wire jumper (example, 6EP1437-3BA00)

## 2.6 Block diagram

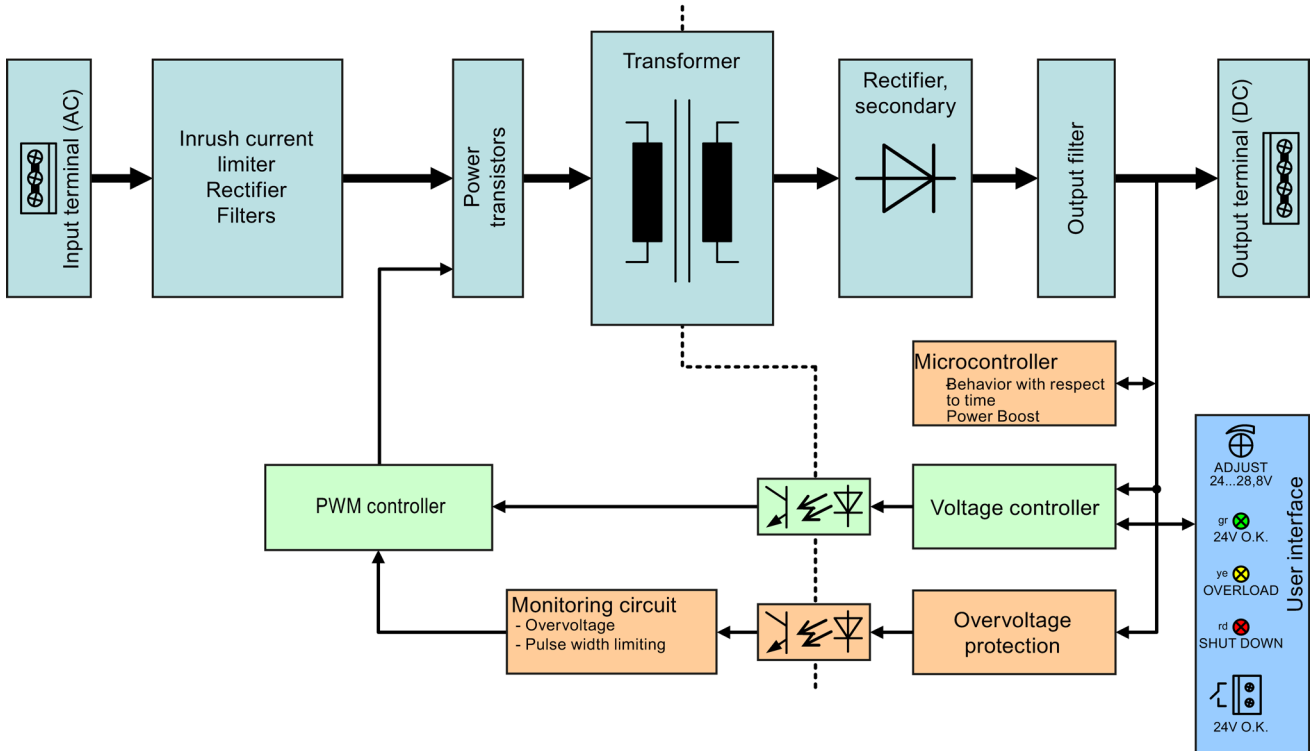

Figure 2-10 Block diagram for 6P1333-3BA10 and 6P1334-3BA10



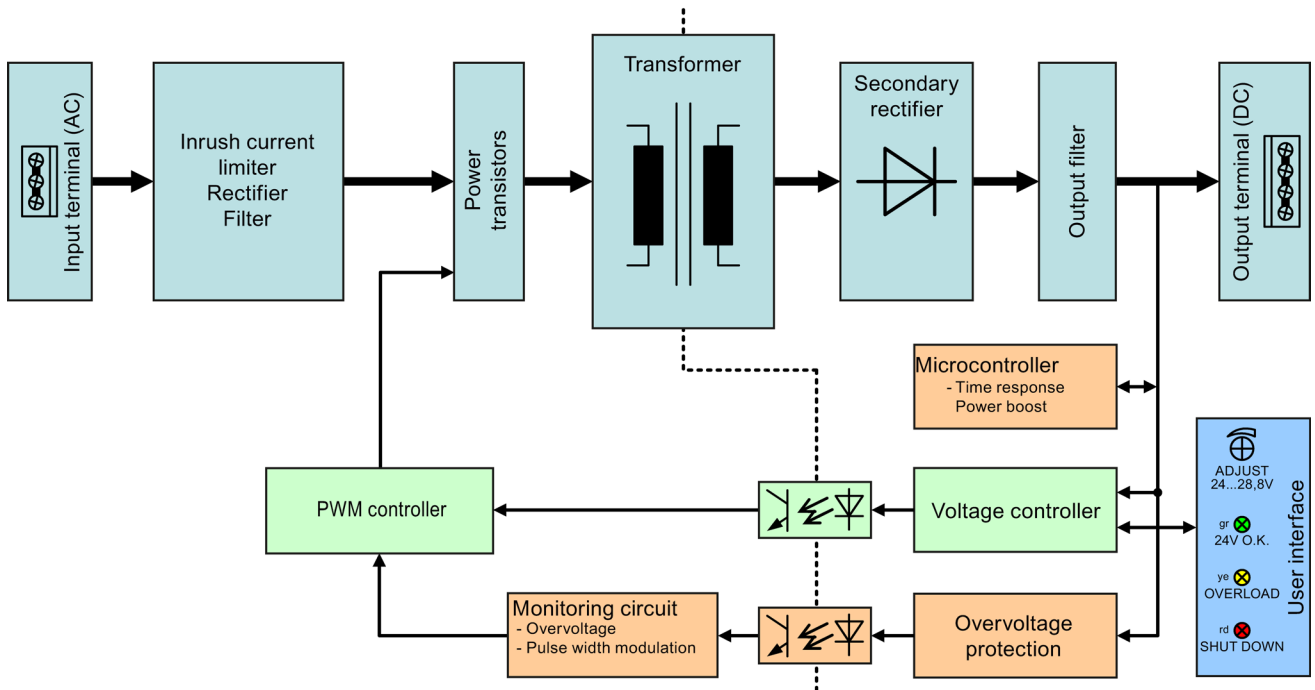

Figure 2-11 Block diagram for 6P1336-3BA00 and 6P1337-3BA00

## 2.7 Dimensions and weight

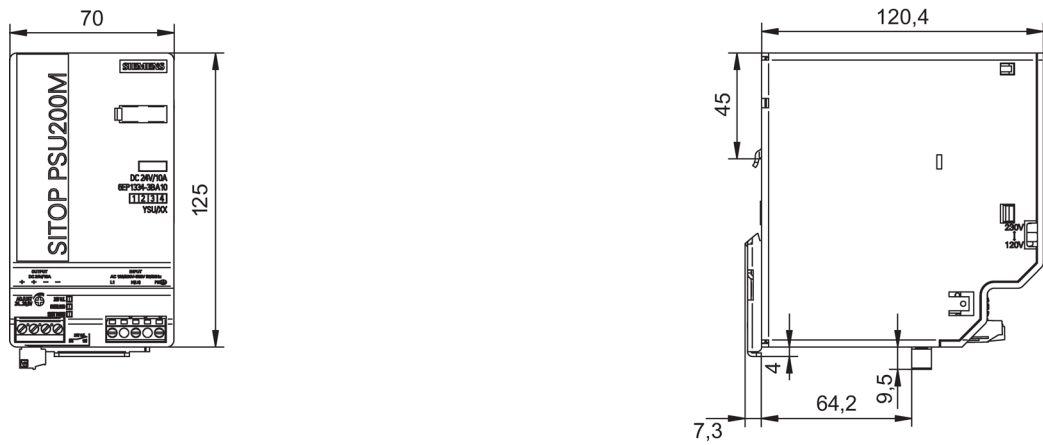

Figure 2-12 Dimension drawing, 6EP1333-3BA10 and 6EP1334-3BA10 (example, 6EP1334-3BA10)

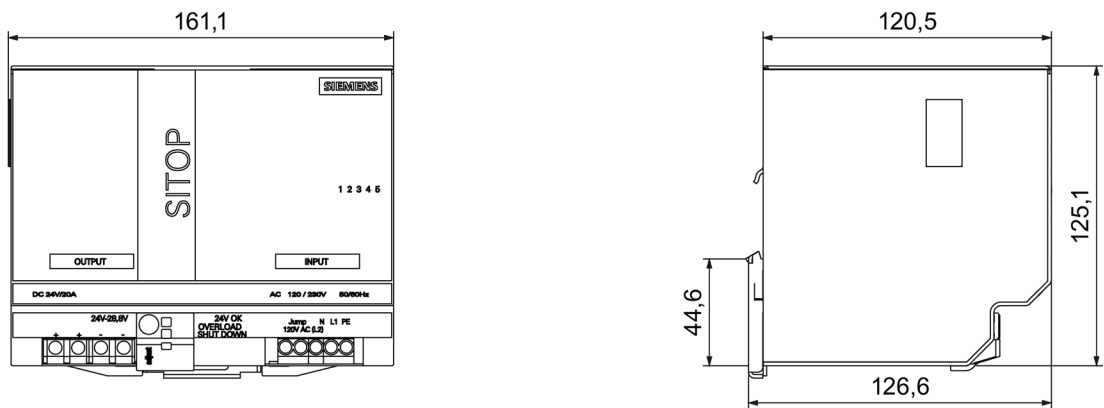

Figure 2-13 Dimension drawing for 6EP1336-3BA00

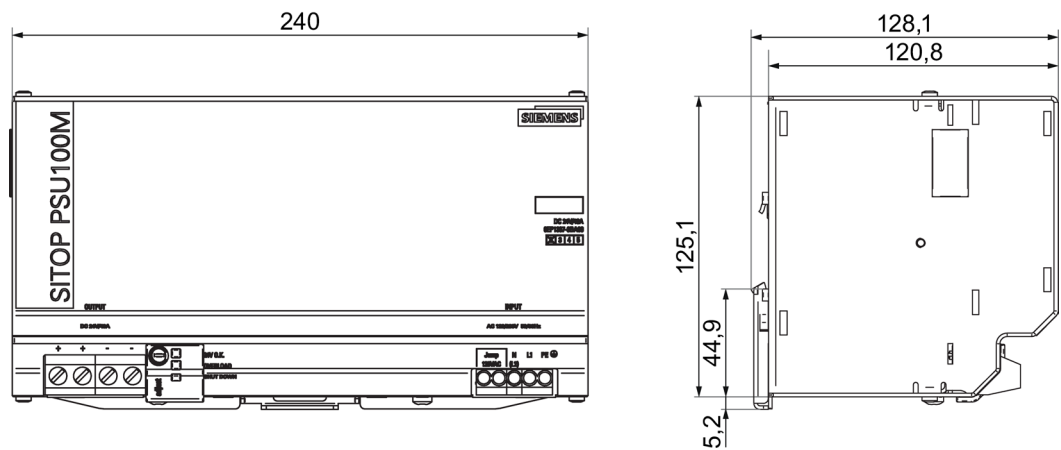

Figure 2-14 Dimension drawing for 6EP1337-3BA00

	6EP1333-3BA10 (24 V/5 A)	6EP1334-3BA10 (24 V/10 A)	6EP1336-3BA00 (24 V/20 A)	6EP1337-3BA00 (24 V/40 A)
Dimensions (W × H × D) in mm	70 × 125 × 120,5	70 × 125 × 120,5	160 × 125 × 120,5	240 × 125 × 120,5
Weight	Approx. 0.6 kg	Approx. 0.8 kg	Approx. 2.2 kg	Approx. 2.9 kg



## Mounting/removal

### **⚠ WARNING**

#### **Installing the device in a housing or a control cabinet**

The SITOP modular power supply is a built-in device. It must be installed in a housing or control cabinet, to which only qualified personnel have access.

The device can be mounted in a control cabinet on standard mounting rails according to EN 60715.

#### **Mounting**

To mount the device, position it with the mounting rail guide at the upper edge of the standard mounting rail and press down to lock it into place. If this is too difficult, press slider ① at the same time, as described under "Removal".

#### **Removing**

To remove, pull up the slider ① using a screwdriver ② and disengage the device at the bottom edge of the standard mounting rail. Then you can remove the device from the upper edge of the standard mounting rail.

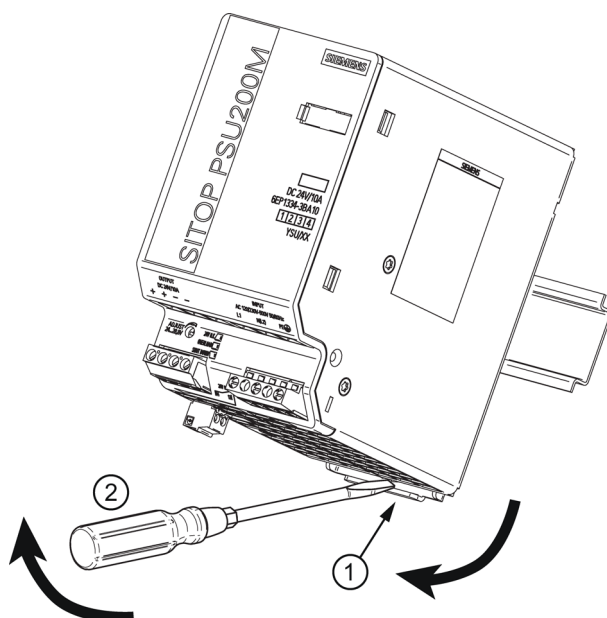

Figure 3-1 Removal (example, 6EP1334-3BA10)

 **WARNING**

**Use in hazardous zones**

If the devices are installed in a hazardous zone (Ex II 3G Ex nA nC IIC T3 Gc or Ex II 3G Ex nA IIC T3 Gc), they must be installed in a distributor box with degree of protection IP54 or higher.

## Mounting position, mounting clearances

### 4.1 Standard mounting position

The device is mounted on standard mounting rails according to EN 60715. The device must be mounted vertically in such a way that the input terminals and the output terminals are at the bottom to ensure correct cooling.

A clearance of at least 50 mm should be maintained above and below the device (maximum depth of the cable duct, 50 mm).

No clearance is required at the side.

### Output current as a function of the ambient temperature and mounting height

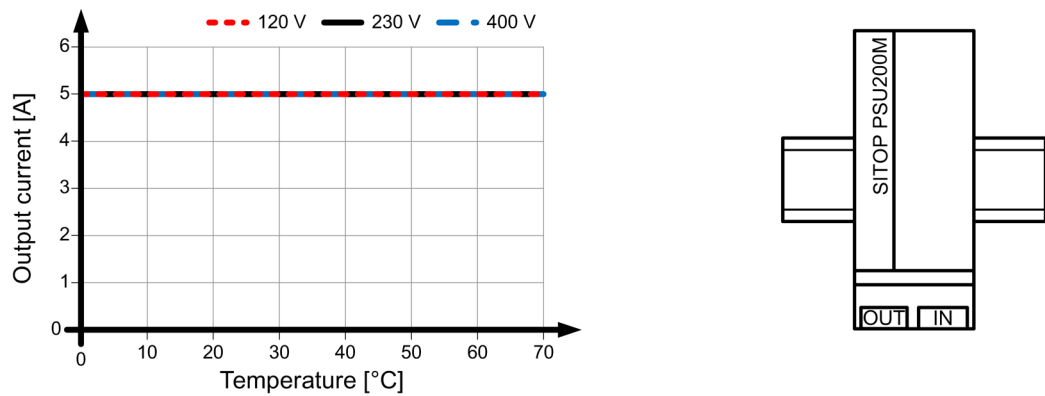

Figure 4-1 6EP1333-3BA10 output current for a standard mounting position

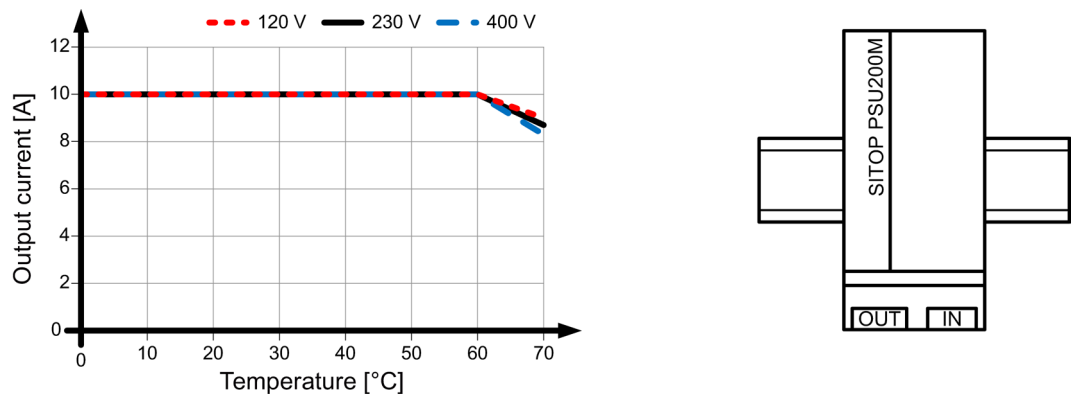

Figure 4-2 6EP1334-3BA10 output current for a standard mounting position

4.1 Standard mounting position

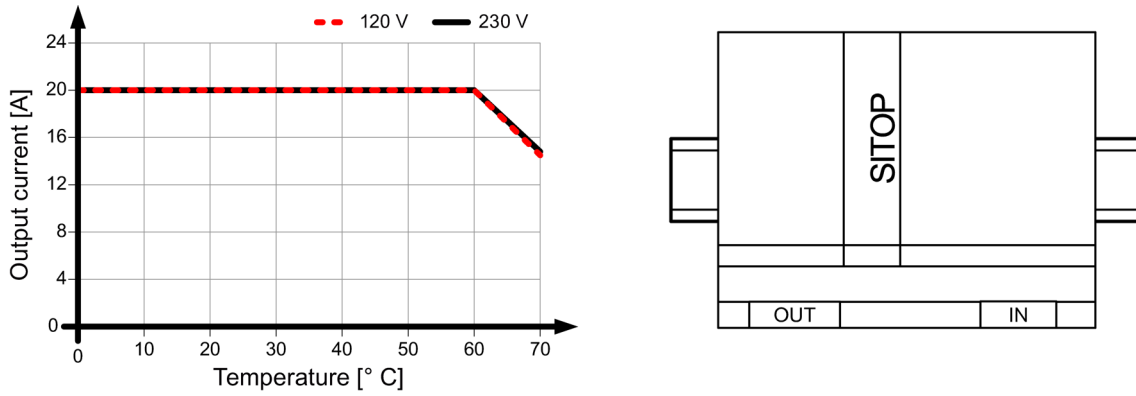

Figure 4-3 6EP1336-3BA00: Output current in the standard mounting position

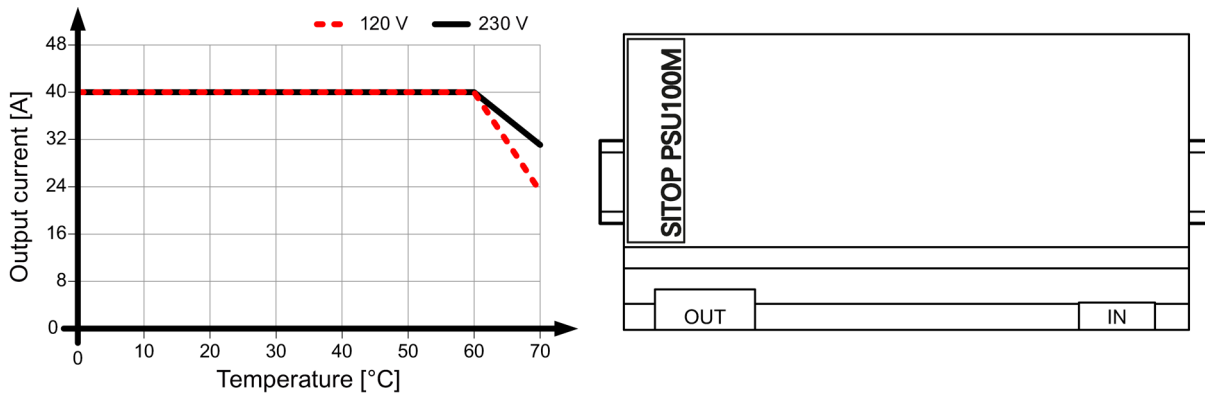

Figure 4-4 6EP1337-3BA00: Output current in the standard mounting position

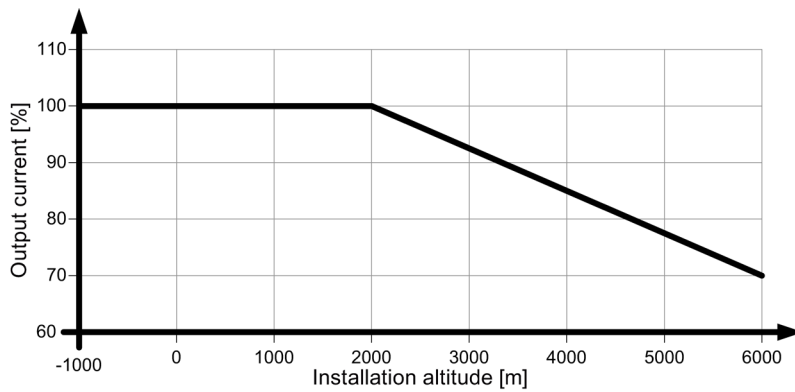

Figure 4-5 Mounting height derating

For details, see Ambient conditions (Page 55)



## 4.2 Other mounting positions

For mounting positions that deviate from the standard mounting position, derating factors (reduction of the output power or the permissible ambient temperature) must be observed in accordance with the following diagrams.

### Note

In the case of mounting positions that deviate from the standard mounting position, reduced mechanical resistance of the devices against vibration and shock must be expected.

Particularly when installing on a vertically fastened standard mounting rail, additional measures may be required, e.g. to prevent the device from slipping on the standard mounting rail.

### 4.2.1 6EP1333-3BA10

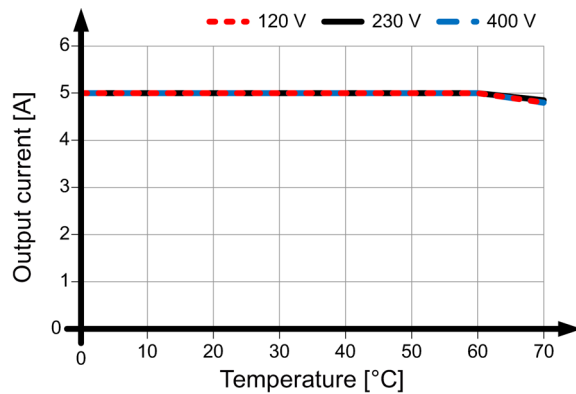

Figure 4-6 6EP1333-3BA10 mounting position (1)

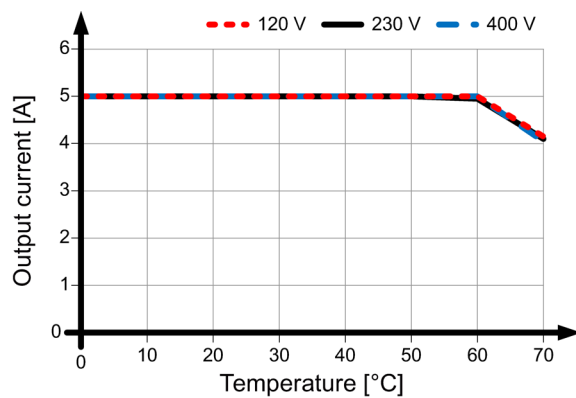
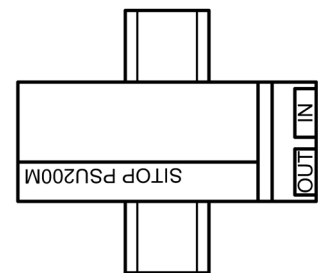
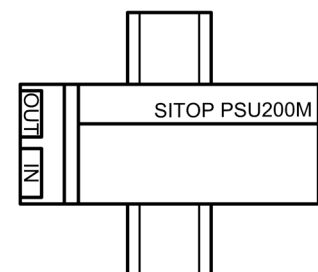

Figure 4-7 6EP1333-3BA10 mounting position (2)



4.2 Other mounting positions

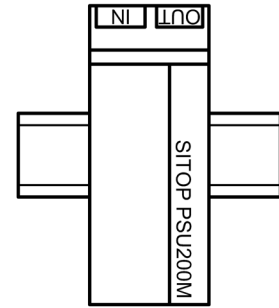
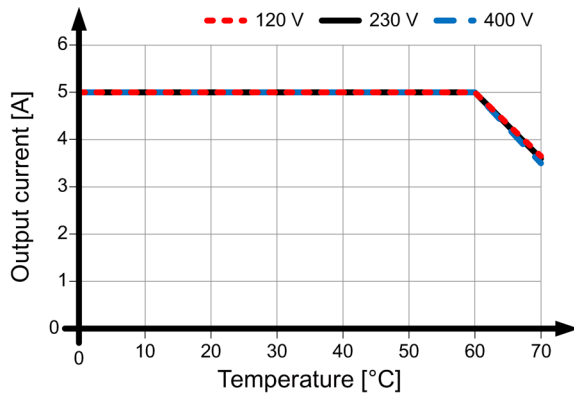

Figure 4-8 6EP1333-3BA10 mounting position (3)

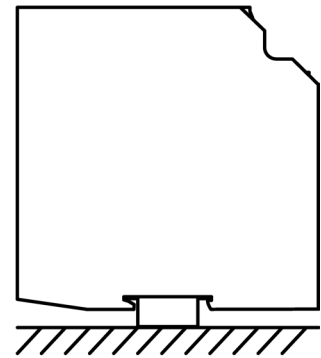
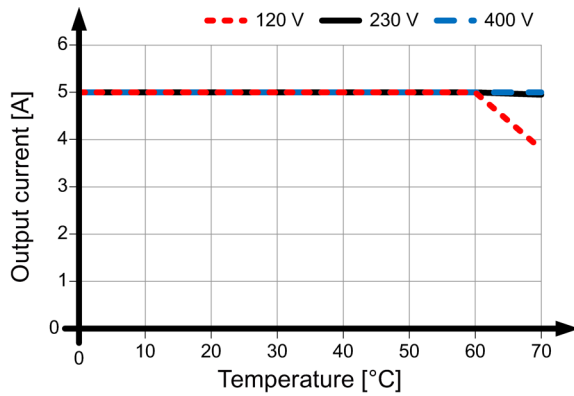

Figure 4-9 6EP1333-3BA10 mounting position (4)

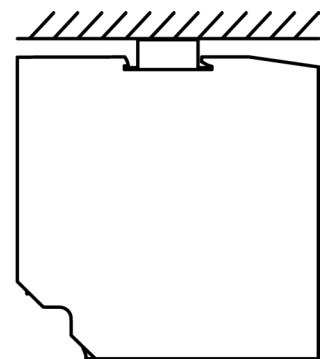
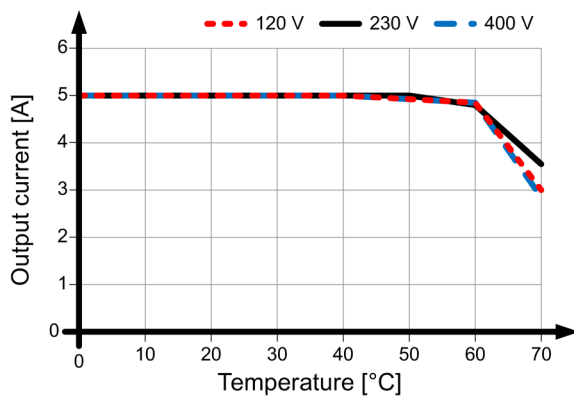

Figure 4-10 6EP1333-3BA10 mounting position (5)

4.2.2 6EP1334-3BA10

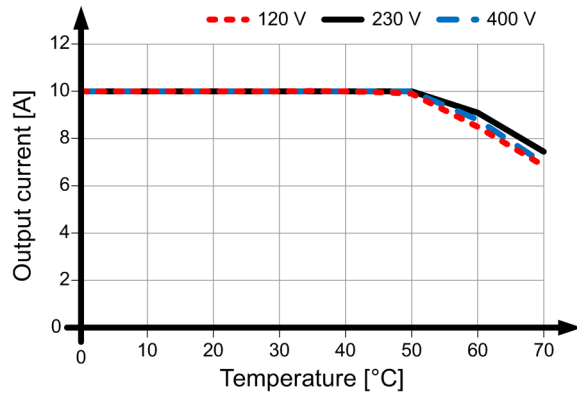

Figure 4-11 6EP1334-3BA10 mounting position (1)

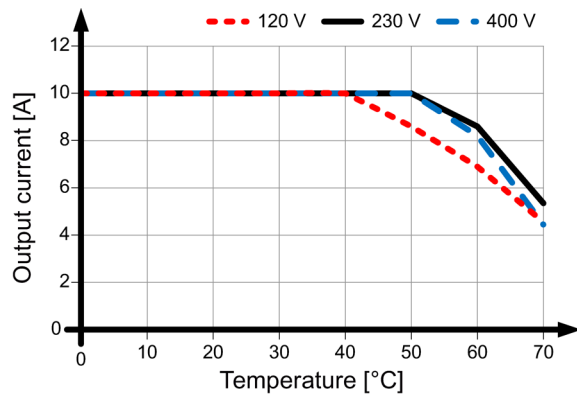
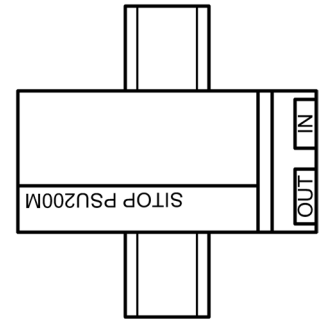

Figure 4-12 6EP1334-3BA10 mounting position (2)

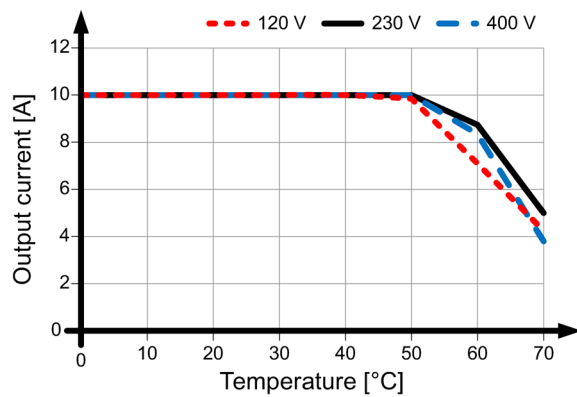
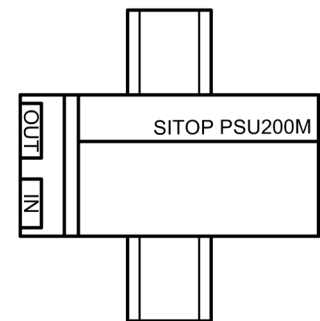
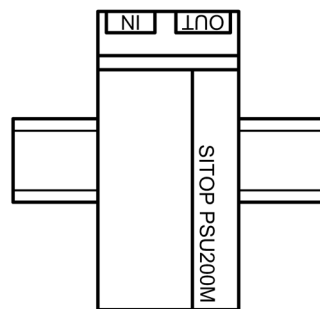

Figure 4-13 6EP1334-3BA10 mounting position (3)



4.2 Other mounting positions

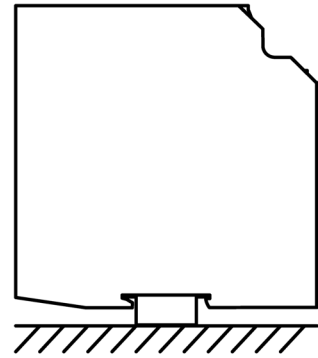
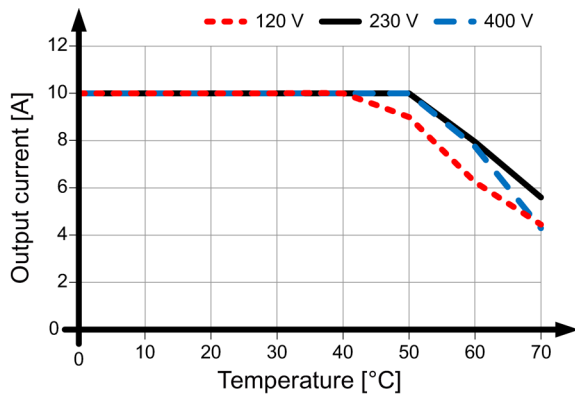

Figure 4-14 6EP1334-3BA10 mounting position (4)

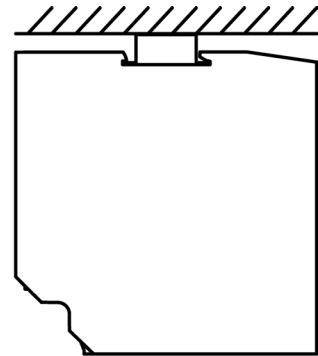
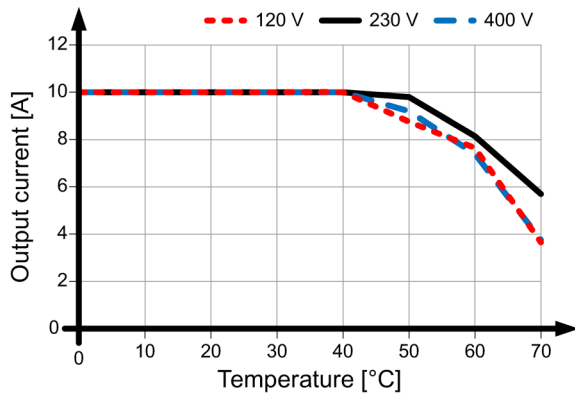

Figure 4-15 6EP1334-3BA10 mounting position (5)

4.2.3 6EP1336-3BA00

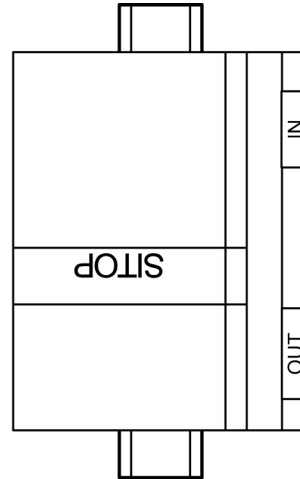
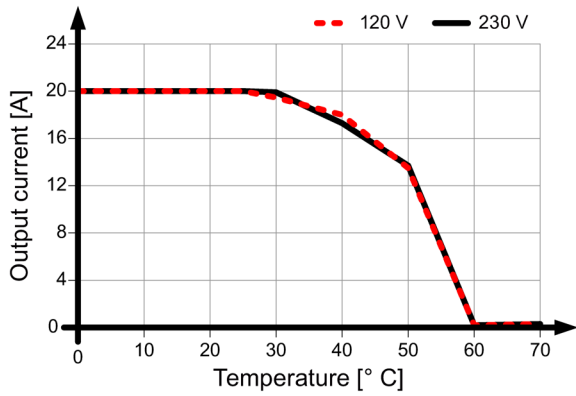

Figure 4-16 6EP1336-3BA00 mounting position (1)

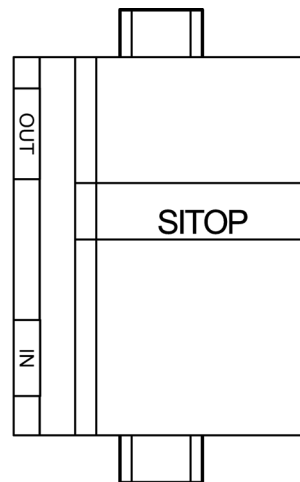
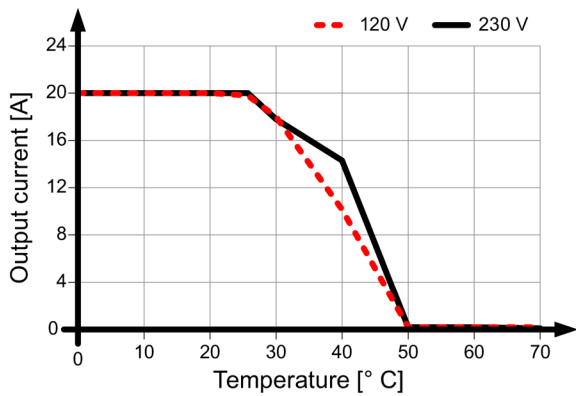

Figure 4-17 6EP1336-3BA00 mounting position (2)

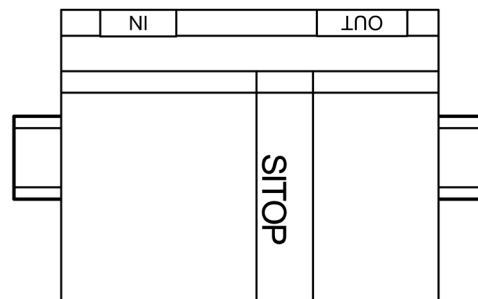
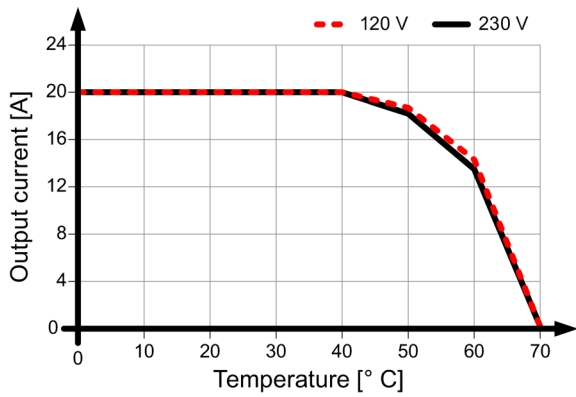

Figure 4-18 6EP1336-3BA00 mounting position (3)

4.2 Other mounting positions

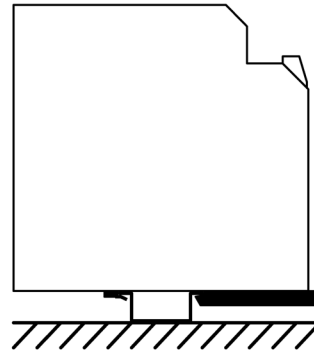
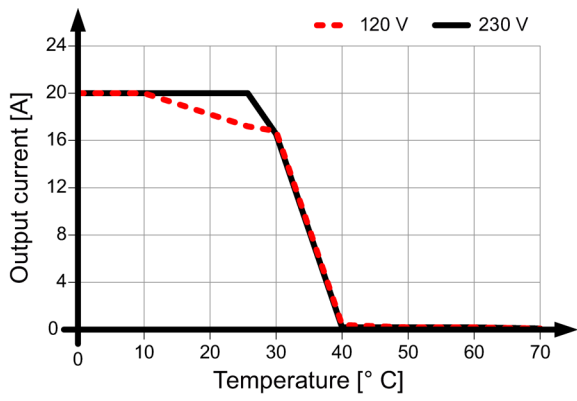

Figure 4-19 6EP1336-3BA00 mounting position (4)

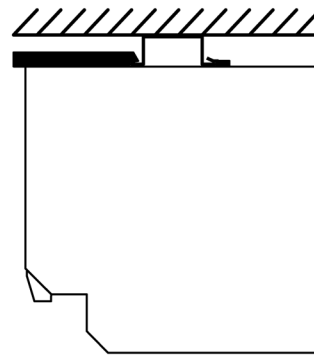
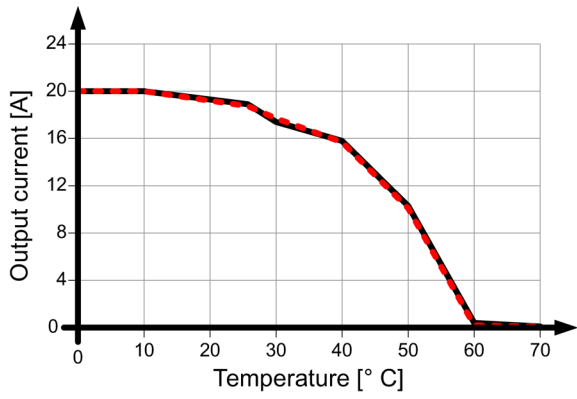

Figure 4-20 6EP1336-3BA00 mounting position (5)

4.2.4 6EP1337-3BA00

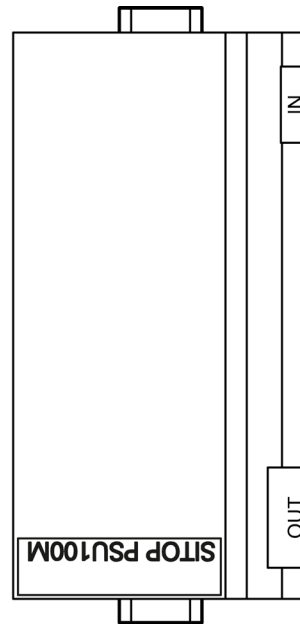
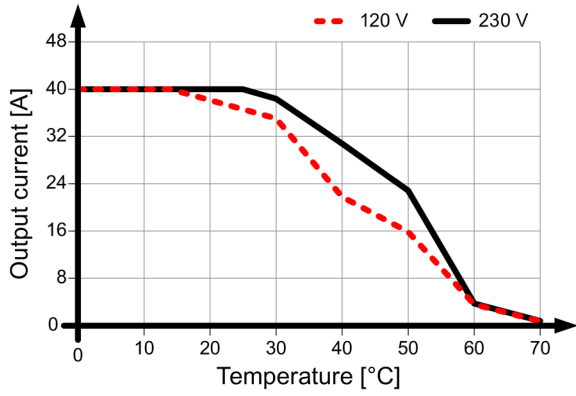

Figure 4-21 6EP1337-3BA00 mounting position (1)

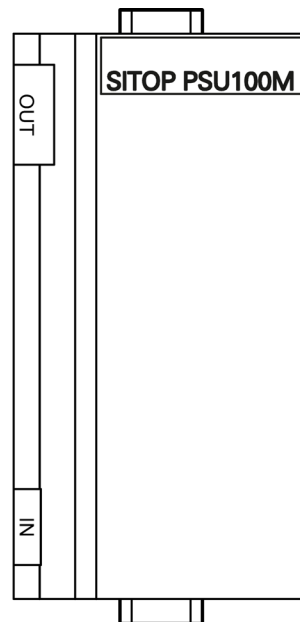
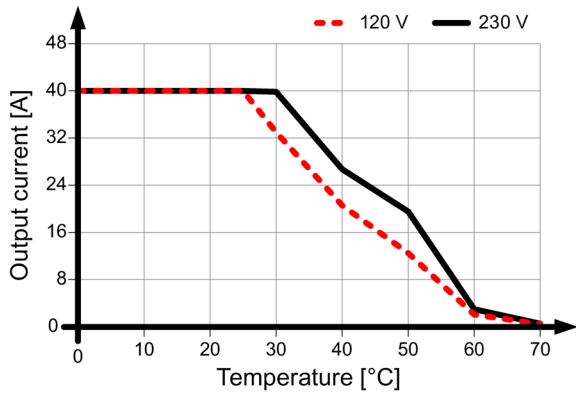

Figure 4-22 6EP1337-3BA00 mounting position (2)

4.2 Other mounting positions

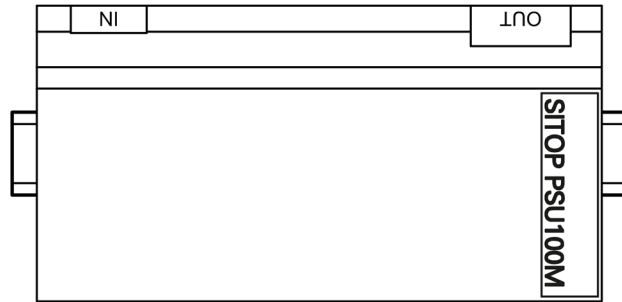
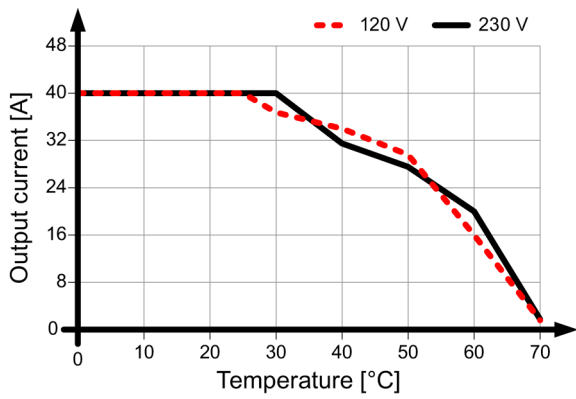

Figure 4-23 6EP1337-3BA00 mounting position (3)

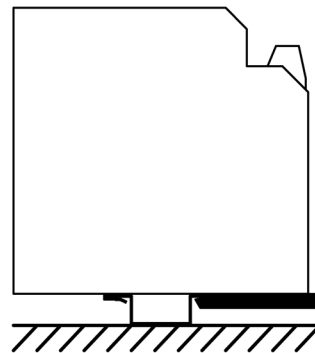
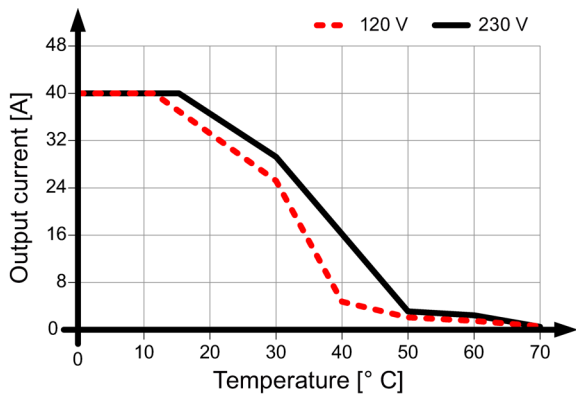

Figure 4-24 6EP1337-3BA00 mounting position (4)

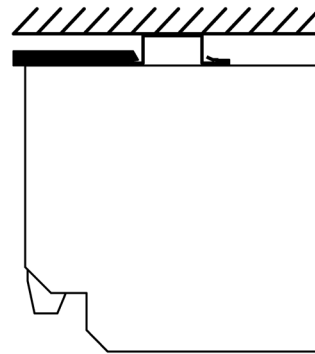
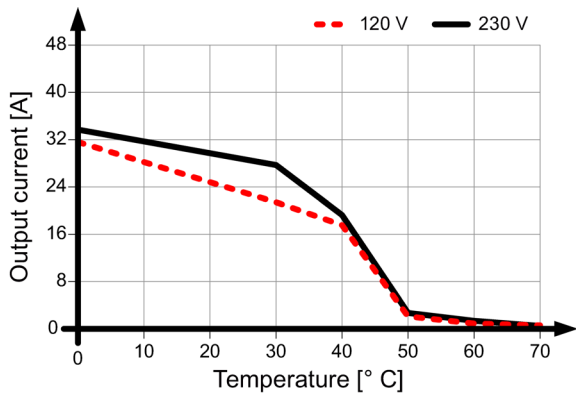

Figure 4-25 6EP1337-3BA00 mounting position (5)



<p><b>⚠ WARNING</b></p> <p><b>Hazard due to electric shock</b></p> <p>Before installation or maintenance work can begin, the system's main switch must be switched off and measures taken to prevent it being switched on again. If this instruction is not observed, touching live parts can result in death or serious injury.</p>
--------------------------------------------------------------------------------------------------------------------------------------------------------------------------------------------------------------------------------------------------------------------------------------------------------------------------------------

## 5.1 Line-side connection

The SITOP modular power supply is designed for connection to a 1-phase/2-phase AC line supply (TN, TT or IT system according to VDE 0100 T 300 / IEC 364-3) with a rated voltage of 120-230/230-500 VAC or 120/230 VAC, 50/60 Hz.

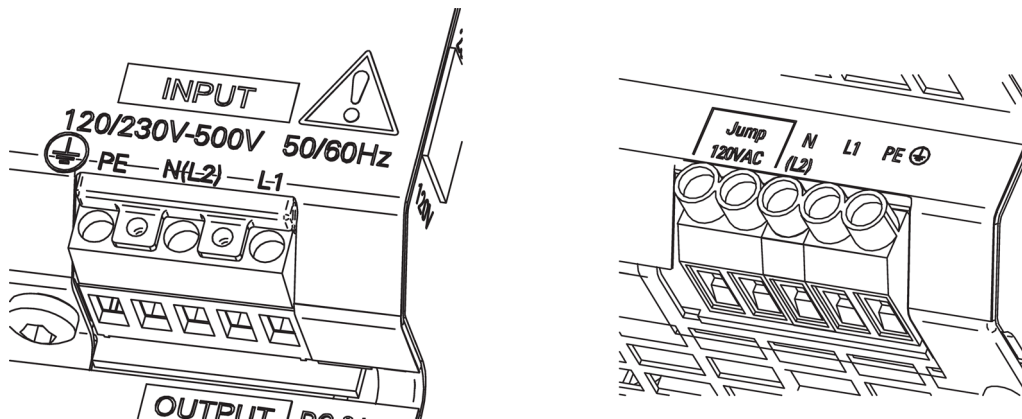

Figure 5-1 Line connection (example, 6EP1334-3BA10 and 6EP1337-3BA00)

The line supply is connected using terminal L1, L2(N) and PE (see Figure 5-1 Line connection (example, 6EP1334-3BA10 and 6EP1337-3BA00) (Page 33)), and must be implemented according to IEC 60364 and EN 50178 .

The switch must be changed over for operation with 120 V input voltage for 6EP1333-3BA10 and 6EP1334-3BA10 (see Figure 2-8 Voltage selector switch (example, 6EP1334-3BA10) (Page 15)). A wire jumper must be connected to the input terminal Jump 120 V AC for 6EP1336-3BA00 and 6EP1337-3BA00 (see Figure 2-9 Wire jumper (example, 6EP1437-3BA00) (Page 15)).

A protective device (miniature circuit-breaker or circuit-breaker) and a disconnection unit for the power supply must be provided. A ground-fault circuit interrupter is not permissible against indirect contact as the only protective measure. This applies for the complete line supply protected by the ground-fault circuit interrupter. If the power supply is operated

*5.1 Line-side connection*

between line conductors L1 and L2 and an RCD is used as protection against direct or indirect contact, then only an AC/DC-sensitive RCD type B is permitted.

## Protection

SITOP modular	Line-side protection recommended for 1-phase operation or required for 2-phase operation
6EP1333-3BA10 (24 V/5 A)	<ul style="list-style-type: none"> <li>1-phase operation: Miniature circuit breaker (IEC 898), characteristic C (B), 6 A (10 A)</li> <li>2-phase operation: 2-pole coupled miniature circuit breaker (IEC 898), characteristic C (B), 6 A (10 A) or for 230 V 3RV2011-1EA10 circuit breaker, setting of the thermal current limiter: 3.8 A or 3RV2711-1ED10 circuit breaker (branch circuit protection according to UL 489) or for 400/500 V 3RV2011-1DA10 circuit breaker, setting of the thermal current limiter: 3 A or 3RV2711-1DD10 circuit breaker (branch circuit protection according to UL 489)</li> </ul>
6EP1334-3BA10 (24 V/10 A)	<ul style="list-style-type: none"> <li>1-phase operation: Miniature circuit breaker (IEC 898), characteristic C (B), 6 A (10 A)</li> <li>2-phase operation: 2-pole coupled miniature circuit breaker (IEC 898), characteristic C (B), 6 A (10 A) or for 230 V 3RV2011-1EA10 circuit breaker, setting of the thermal current limiter: 3.8 A or 3RV2711-1ED10 circuit breaker (branch circuit protection according to UL 489) or for 400/500 V 3RV2011-1DA10 circuit breaker, setting of the thermal current limiter: 3 A or 3RV2711-1DD10 circuit breaker (branch circuit protection according to UL 489)</li> </ul>
6EP1336-3BA00 (24 V/20 A)	<ul style="list-style-type: none"> <li>1-phase operation: Miniature circuit breaker (IEC 898), characteristic C, 10 A</li> <li>2-phase operation: 2-pole coupled miniature circuit breaker (IEC 898), characteristic C, 10 A or for 120 V 3RV2411-1JA10 circuit breaker or for 230 V 3RV2411-1FA10 circuit breaker</li> </ul>
6EP1337-3BA00 (24 V/40 A)	<ul style="list-style-type: none"> <li>1-phase operation: Miniature circuit breaker (IEC 898), characteristic C, 20 A</li> <li>2-phase operation: 2-pole coupled miniature circuit breaker (IEC 898), characteristic C, 20 A or for 120 V 3RV2421-4BA10 circuit breaker or for 230 V 3RV2411-1JA10 circuit breaker</li> </ul>

The protective conductor of the line supply must be connected at the PE terminal.

Other country-specific regulations may have to be observed when installing the device.

## 5.2 Output-side connection

At its output, the SITOP modular power supply provides an isolated (= non-grounded) SELV output voltage (Safety Extra Low Voltage). The output of the power supply is no-load, overload, and short-circuit proof. If an overload occurs, the electronic current limiting function limits the output current to a maximum value (refer to Chapter Technical data (Page 37)).

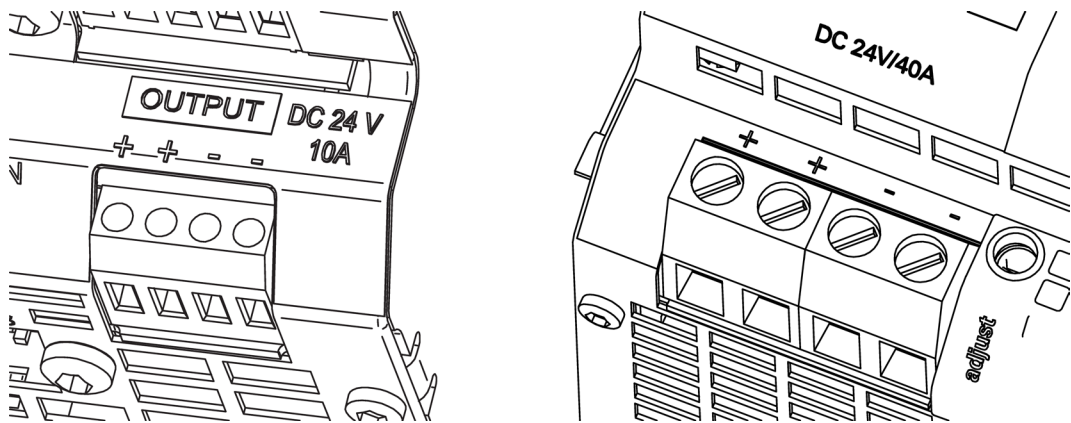

Figure 5-2 Output connection (example, 6EP1334-3BA10 and 6EP1337-3BA00)

The output voltage is connected via the + and - terminals at the output of the power supply (see Figure 5-2 Output connection (example, 6EP1334-3BA10 and 6EP1337-3BA00) (Page 36)). Ensure that the output cables are dimensioned correctly for the maximum output current rms value and fused accordingly.

### Note

If the safety concept of the plant or system specifies that the DC output circuit should be grounded (PELV, Protected Extra Low Voltage), then it is permissible that the output voltage of the SITOP power supply is grounded. In this case, ideally, the grounding at the output should be directly connected from terminal "-" of the power supply to a suitable connection point of the protective conductor system (PE) of the plant or system.

## Technical data

### Note

Technical data is applicable for a rated input voltage of 230 VAC, rated load and +25° C ambient temperature (if nothing else is specified).

## 6.1 Input

	6EP1333-3BA10 (24 V/5 A)	6EP1334-3BA10 (24 V/10 A)	6EP1336-3BA00 (24 V/20 A)	6EP1337-3BA00 (24 V/40 A)
Input	1-phase and 2-phase AC			
Rated voltage value U <sub>e</sub> rated	120...230 / 230...500 V	120...230 / 230...500 V	120/230 V	120/230 V
Voltage range	85...264 / 176...550 V	85...264 / 176...550 V	85...132 / 176...264 V	85...132 / 176...264 V
• Remark	Setting via selector switch on the device; starting from U <sub>e</sub> > 90/180 V  Derating for -25 to 0 °C: Starting with max. 500 V	Setting via selector switch on the device; starting from U <sub>e</sub> > 90/180 V  Derating for -25 to 0 °C: Starting with max. 500 V	Setting via wire jumper on the device; start-up as of U <sub>e</sub> > 93/183 V	Setting via wire jumper on the device; start-up as of U <sub>e</sub> > 95/190 V
Wide-range input	Yes		No	
Overvoltage strength	2.3 × U <sub>e</sub> rated, 1.3 ms			
Power failure buffering at I <sub>a</sub> rated, min	25 ms	25 ms	20 ms	20 ms
Power-failure buffering	For U <sub>e</sub> = 120/230 V, typ. 150 ms for U <sub>e</sub> = 500 V	For U <sub>e</sub> = 120/230 V, typ. 150 ms for U <sub>e</sub> = 500 V	at U <sub>e</sub> = 230 V	at U <sub>e</sub> = 230 V
Rated line frequency	50/60 Hz			
Line frequency range	47...63 Hz			
Input current / at rated value of input voltage 120 V	2.2 A	4.4 A	7.7 A	15 A
Input current / at rated value of input voltage 230 V	1.2 A	2.4 A	3.5 A	8 A
Input current / at rated value of input voltage 500 V	0.61 A	1.1 A	-	-

Technical data

6.1 Input

	6EP1333-3BA10 (24 V/5 A)	6EP1334-3BA10 (24 V/10 A)	6EP1336-3BA00 (24 V/20 A)	6EP1337-3BA00 (24 V/40 A)
Switch-on current limitation (+ 25° C), max.	35 A	35 A	60 A	125 A
I <sup>2</sup> t, max	1.7 A <sup>2</sup> s	4 A <sup>2</sup> s	9.9 A <sup>2</sup> s	26 A <sup>2</sup> s
Integrated input fuse	Fuse T 3.15 A	Fuse T 6.3 A	Fuse T 10 A	Fuse T 16 A
Protection in the line feeder cable (IEC 898)	Recommended for 1-phase operation: Miniature circuit breaker, characteristic C (B), 6 A (10 A); Required for 2-phase operation: 2-pole coupled miniature circuit breaker, characteristic C (B), 6 A (10 A) or for 230 V, 3RV2011-1EA10 circuit breaker, (setting 3.8 A) or 3RV2711-1ED10 circuit breaker or for 400/500 V, 3RV2011-1DA10 circuit breaker, (setting 3 A) or 3RV2711-1DD10 circuit breaker	Recommended for 1-phase operation: Miniature circuit breaker, characteristic C, 10 A; Required for 2-phase operation: 2-pole coupled miniature circuit breaker, characteristic C, 10 A or for 120 V, 3RV2411-1JA10 circuit breaker or for 230 V, 3RV2411-1FA10 circuit breaker	Recommended for 1-phase operation: Miniature circuit breaker, characteristic C, 20 A; Required for 2-phase operation: 2-pole coupled miniature circuit breaker, characteristic C, 20 A or for 120 V, 3RV2421-4BA10 circuit breaker or for 230 V, 3RV2411-1JA10 circuit breaker	Recommended for 1-phase operation: Miniature circuit breaker, characteristic C, 20 A; Required for 2-phase operation: 2-pole coupled miniature circuit breaker, characteristic C, 20 A or for 120 V, 3RV2421-4BA10 circuit breaker or for 230 V, 3RV2411-1JA10 circuit breaker

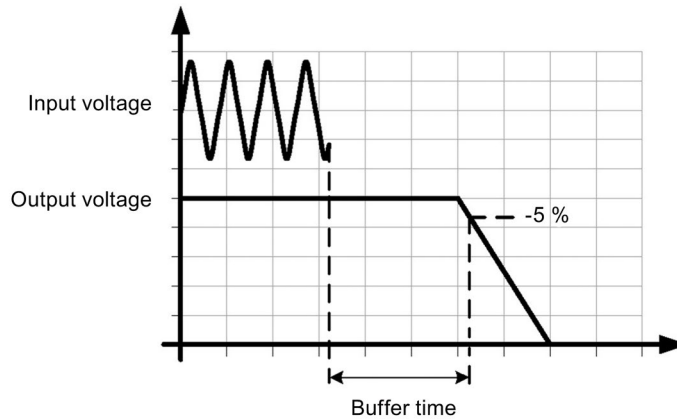

Figure 6-1 Power-failure buffering

## 6.2 Output

	6EP1333-3BA10 (24 V/5 A)	6EP1334-3BA10 (24 V/10 A)	6EP1336-3BA00 (24 V/20 A)	6EP1337-3BA00 (24 V/40 A)
Output	Regulated, isolated DC voltage			
Rated voltage value U <sub>a</sub> rated DC	24 V			
Total tolerance, static ±	3 %	3 %	3 %	3 %
Static line regulation, approx.	0,1 %	0,1 %	0,1 %	0,1 %
Static load regulation, approx.	0,1 %	0,1 %	0,1 %	0,1 %
Residual ripple in the load range	50 mV	50 mV	100 mV	100 mV
Peak-peak, max.				
Spikes peak-peak, max. (bandwidth, approx. 20 MHz)	200 mV	200 mV	200 mV	200 mV
Adjustment range	24...28.8 V			
Product function / output voltage can be adjusted	Yes			
Output voltage setting	Via potentiometer			
• Remark				
	Max. 120 W	Max. 240 W	Max. 480 W	Max. 960 W
Output derating U <sub>a</sub> /T	See Figure 6-7 Output derating depending on the ambient temperature at I <sub>a</sub> rated (Page 42)			
Output derating U <sub>a</sub> /I <sub>a</sub>	See Figure 6-8 Output derating depending on the output current at 60° C (Page 42)			
Output derating U <sub>a</sub> /U <sub>i</sub>	-	-	-	See Figure 6-9 Output derating depending on the input voltage (Page 43)
• Remark				The output voltage must not be set higher than 24 V for 85 to 93 VAC.
Response when switching on/off	Overshoot of U <sub>a</sub> approx. 3%			
Starting delay, max.	1 s	1 s	0.1 s	0.1 s
Voltage rise, typ.	50 ms	50 ms	50 ms	50 ms
Voltage rise time of the output voltage, maximum	500 ms	500 ms	500 ms	500 ms
Rated current value I <sub>a</sub> rated	5 A	10 A	20 A	40 A
Current range	0...5 A	0...10 A	0...20 A	0...40 A
• Remark		+60°...+70° C derating: Approx. 2% I <sub>a</sub> rated/K	+60°...+70° C derating: Approx. 2% I <sub>a</sub> rated/K	+60°...+70° C derating: Approx. 2% I <sub>a</sub> rated/K
Output active power / typical	120 W	240 W	480 W	960 W

Technical data

6.2 Output

	6EP1333-3BA10 (24 V/5 A)	6EP1334-3BA10 (24 V/10 A)	6EP1336-3BA00 (24 V/20 A)	6EP1337-3BA00 (24 V/40 A)
Constant overload current for a short circuit when powering up, typical	6 A	12 A	23 A	46 A
Short-time overload current for a short circuit during operation, typical	15 A	30 A	60 A	120 A
Duration of the overcurrent overload capability for a short circuit during operation	25 ms	25 ms	25 ms	25 ms
• Remark	Every 1 min	Every 1 min	Every 1 min	Every 1 min
Can be connected in parallel to increase the power rating	Yes			
• Remark	Switchable characteristic curve with switch A (see Status displays and signaling (Page 13))			
Number of devices that can be connected in parallel to increase the power rating, quantity	2			
Output characteristic	See Figure 6-3 6EP1333-3BA10 single operation output characteristic (Page 41)	See Figure 6-4 6EP1334-3BA10 single operation output characteristic (Page 41)	See Figure 6-5 6EP1336-3BA00 single operation output characteristic (Page 41)	See Figure 6-6 6EP1337-3BA00 single operation output characteristic (Page 42)

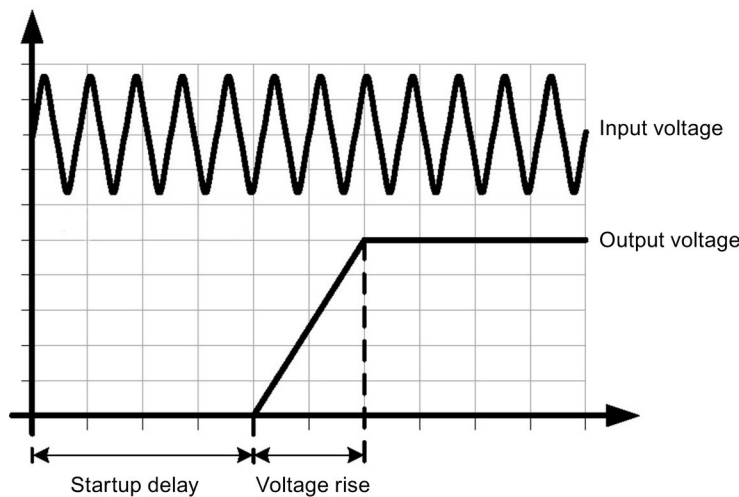

Figure 6-2 Startup delay/voltage rise



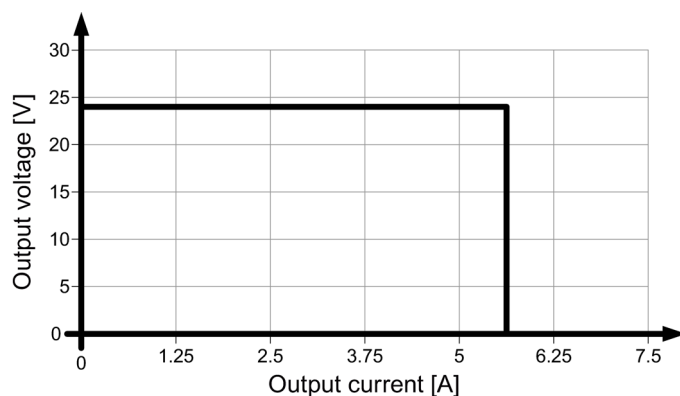

Figure 6-3 6EP1333-3BA10 single operation output characteristic

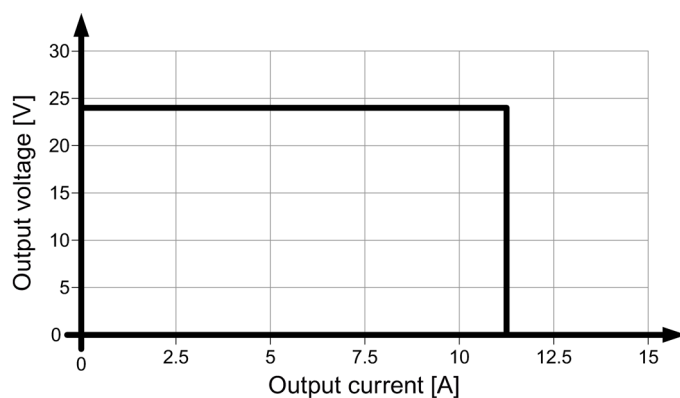

Figure 6-4 6EP1334-3BA10 single operation output characteristic

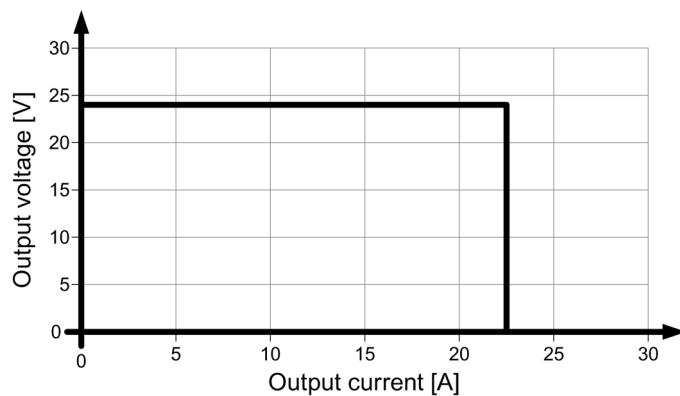

Figure 6-5 6EP1336-3BA00 single operation output characteristic

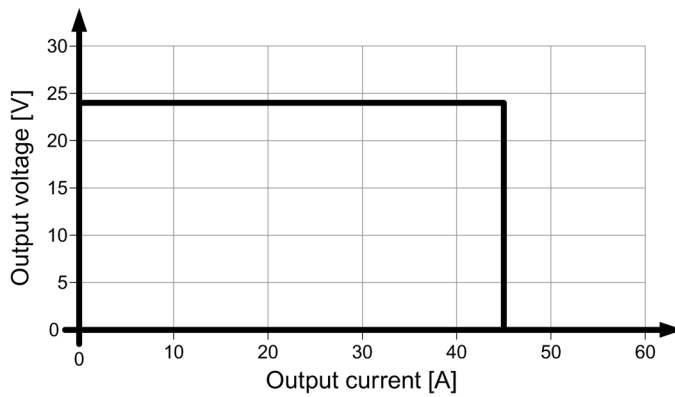

Figure 6-6 6EP1337-3BA00 single operation output characteristic

The device supplies a constant output voltage until the current limit is reached. In the event of an overload, the output current and the output voltage are reduced.

**Derating for  $U_a > 24$  V:**

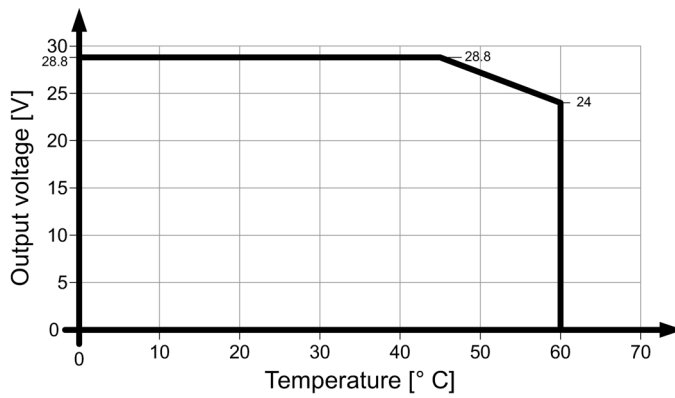

Figure 6-7 Output derating depending on the ambient temperature at  $I_a$  rated

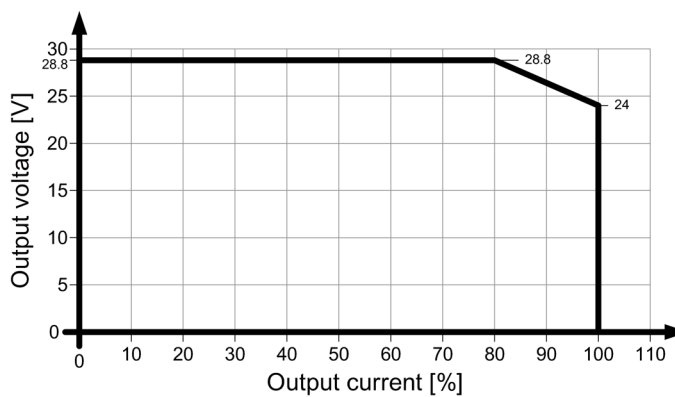

Figure 6-8 Output derating depending on the output current at 60° C

Derating for  $U_a > 24\text{ V}$  depending on the input voltage (only valid for 6EP1337-3BA00):

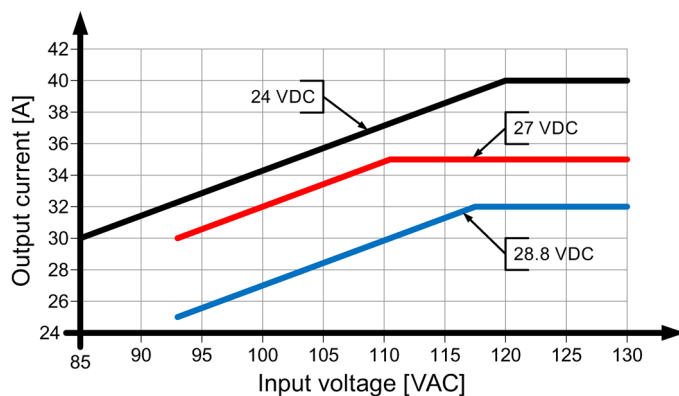

Figure 6-9 Output derating depending on the input voltage

The output voltage must not be set higher than 24 V for 85 to 93 VAC.

**Change-over switch A on:**

Parallel operation. The output voltage falls with increasing output current.

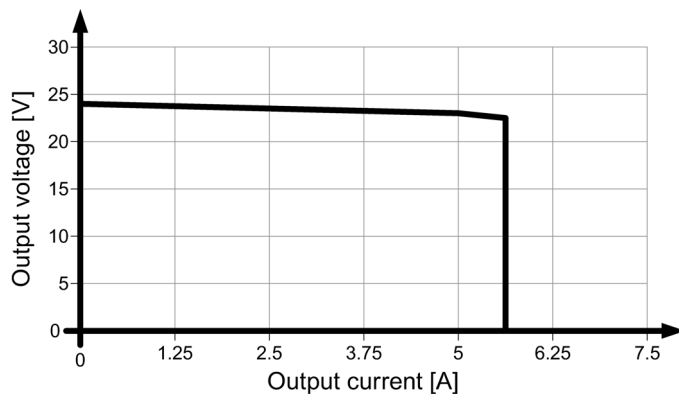

Figure 6-10 6EP1333-3BA10 parallel operation output characteristic

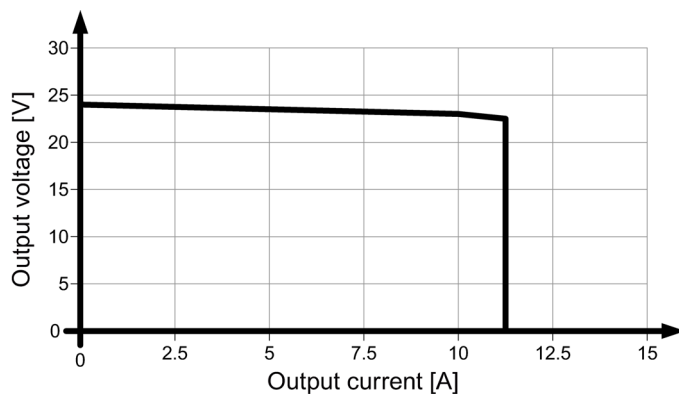

Figure 6-11 6EP1334-3BA10 parallel operation output characteristic

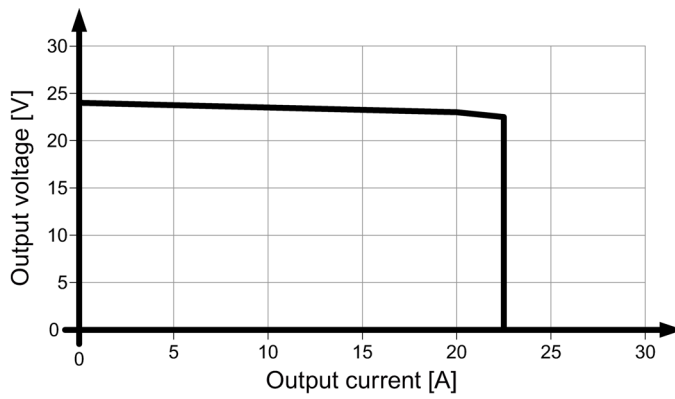

Figure 6-12 6EP1336-3BA00 parallel operation output characteristic

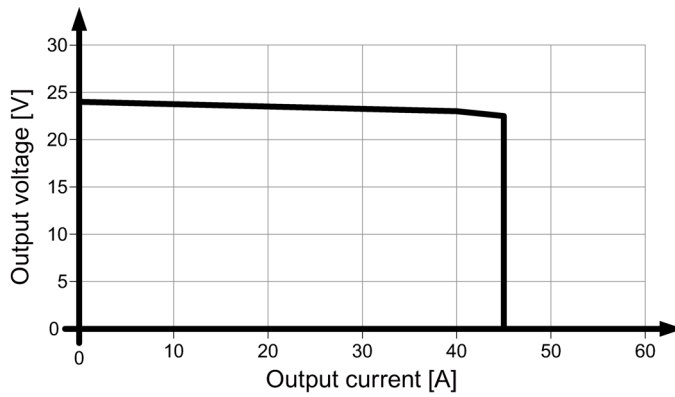

Figure 6-13 6EP1337-3BA00 parallel operation output characteristic

**Change-over switch B on:**

Latching shutdown. The device is shutdown if the overload lasts longer than 100 ms. Turning the power supply off for longer than 5 s causes a reset.

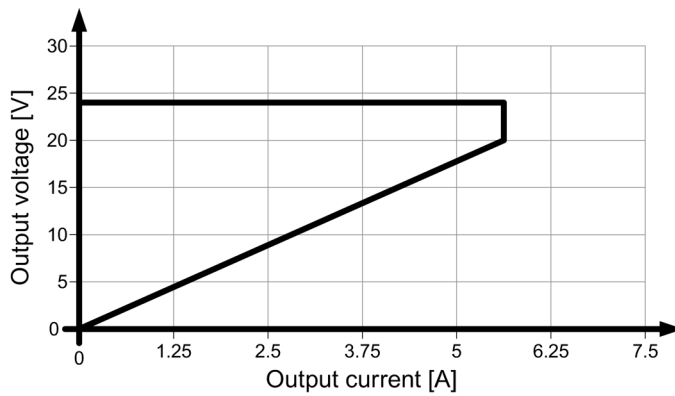

Figure 6-14 6EP1333-3BA10 latching shutdown output characteristic

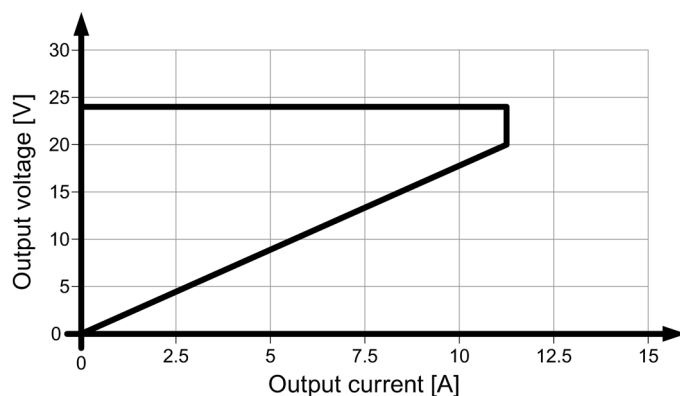

Figure 6-15 6EP1334-3BA10 latching shutdown output characteristic

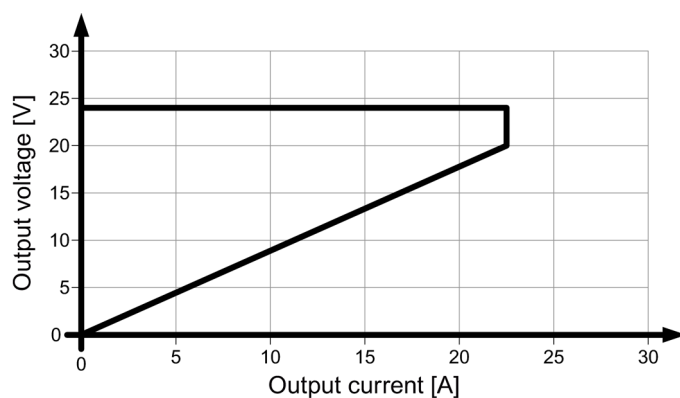

Figure 6-16 6EP1336-3BA00 latching shutdown output characteristic

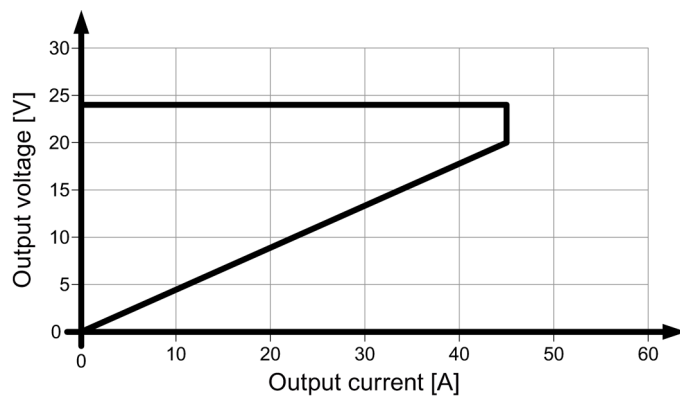

Figure 6-17 6EP1337-3BA00 latching shutdown output characteristic

### 6.3 Efficiency

	6EP1333-3BA10 (24 V/5 A)	6EP1334-3BA10 (24 V/10 A)	6EP1336-3BA00 (24 V/20 A)	6EP1337-3BA00 (24 V/40 A)
Efficiency at $U_a$ rated, $I_a$ rated, approx.	88 %	91 %	89 %	88 %
Power loss at $U_a$ rated, $I_a$ rated, approx.	17 W	24 W	59 W	131 W
No-load operation power loss, approx.	4 W	6 W	3 W	20 W
Power loss in the "latching shutdown" state	2 W	2 W	3 W	3 W

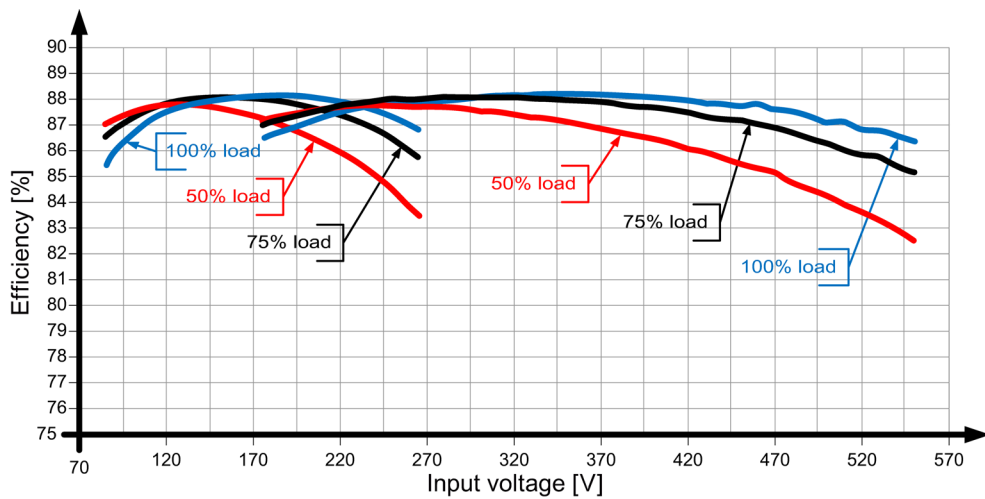

Figure 6-18 6EP1333-3BA10 efficiency

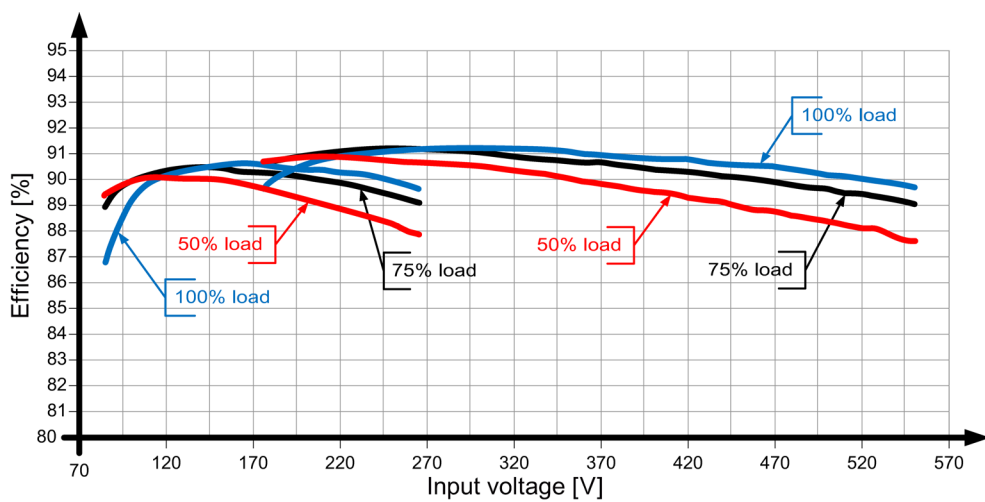

Figure 6-19 6EP1334-3BA10 efficiency

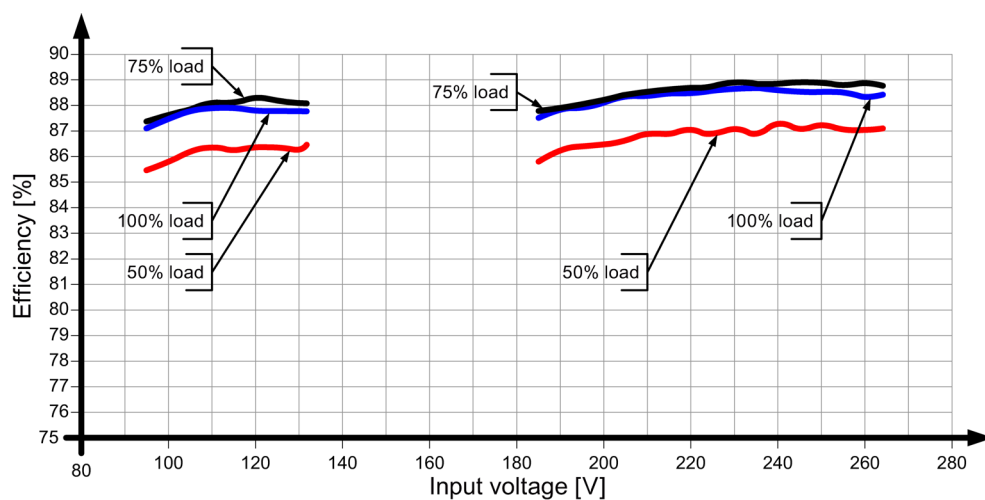

Figure 6-20 6EP1336-3BA00 efficiency

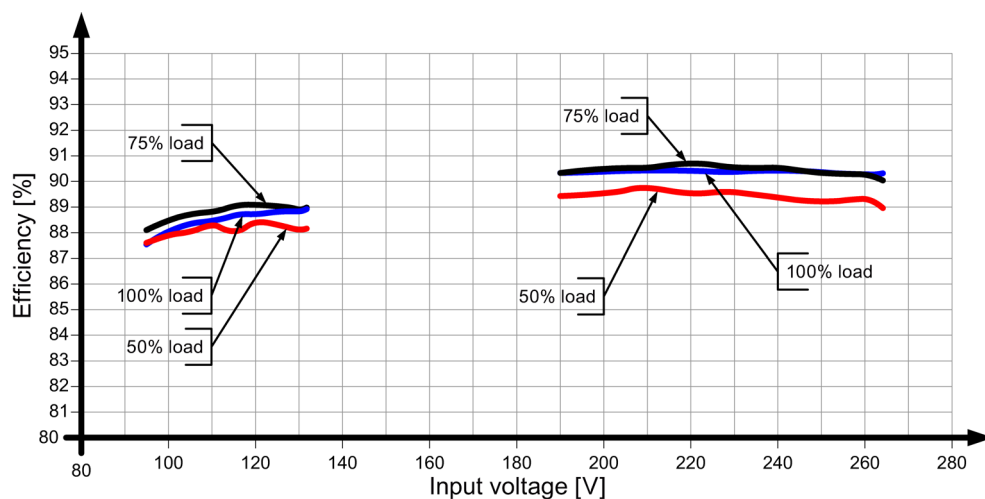

Figure 6-21 6EP1337-3BA00 efficiency

## 6.4 Closed-loop control

	6EP1333-3BA10 (24 V/5 A)	6EP1334-3BA10 (24 V/10 A)	6EP1336-3BA00 (24 V/20 A)	6EP1337-3BA00 (24 V/40 A)
Dyn. line regulation (U <sub>e</sub> rated ±15%), max.	0,1 %	0,1 %	1 %	1 %
Dyn. load regulation (I <sub>a</sub> : 50/100/50%), U <sub>a</sub> ± typ.	3 %	3 %	2 %	2 %
Load step regulation time 50 to 100%, typ.	2 ms	2 ms	2 ms	2 ms
Load step regulation time 100 to 50%, typ.	2 ms	2 ms	2 ms	2 ms
Regulation time / maximum	5 ms	5 ms	5 ms	5 ms

## 6.5 Protection and monitoring

	6EP1333-3BA10 (24 V/5 A)	6EP1334-3BA10 (24 V/10 A)	6EP1336-3BA00 (24 V/20 A)	6EP1337-3BA00 (24 V/40 A)
Output overvoltage protection	< 35 V	< 35 V	< 35 V	< 35 V
Current limitation, typ.	5.5 A	12 A	23 A	46 A
Property of the output/short-circuit proof	Yes			
Short-circuit protection	Optional constant current characteristic curve or latching shutdown			
Continuous short-circuit current / rms value / typical	5.5 A	12 A	23 A	46 A
Overload / short-circuit display	Yellow LED for "overload", red LED for "latching shutdown"			

## 6.6 MTBF

	6EP1333-3BA10 (24 V/5 A) 6EP1334-3BA10 (24 V/10 A) 6EP1336-3BA00 (24 V/20 A) 6EP1337-3BA00 (24 V/40 A)
Mean Time Between Failures	SN29500: >500000 h (typ. 700000 h) at 40° C, rated load, 24 h operation



## 6.7 Mechanical system

	<b>6EP1333-3BA10 (24 V/5 A)</b>	<b>6EP1334-3BA10 (24 V/10 A)</b>	<b>6EP1336-3BA00 (24 V/20 A)</b>	<b>6EP1337-3BA00 (24 V/40 A)</b>
Connection system	Screw-type terminal			
Connections / line supply	L1, N (L2), PE: 1 screw terminal each for 0.05 ... 4 mm <sup>2</sup> solid (finely stranded)	L1, N (L2), PE:: 1 screw terminal each for 0.05 ... 4 mm <sup>2</sup> solid (finely stranded)	L1, N (L2), PE, Jump 120VAC: 1 screw terminal each for 0.2 ... 6 (4) mm <sup>2</sup> solid (finely stranded)	L1, N (L2), PE, Jump 120VAC: 1 screw terminal each for 0.2 ... 6 (4) mm <sup>2</sup> solid (finely stranded)
Connections / output	+, -: 2 screw terminals each for 0.2 ... 4 (2.5) mm <sup>2</sup> solid (finely stranded)	+, -: 2 screw terminals each for 0.2 ... 4 (2.5) mm <sup>2</sup> solid (finely stranded)	+, -: 2 screw terminals each for 0.2 ... 6 (4) mm <sup>2</sup> solid (finely stranded)	+, -: 2 screw terminals each for 0.5 ... 16 (10) mm <sup>2</sup> solid (finely stranded)
Connections / auxiliary contacts	Signaling contact: 1 screw terminal each for 0.14 ... 1.5 mm <sup>2</sup> solid (finely stranded)		-	-
Width of the housing	70 mm	70 mm	160 mm	240 mm
Height of the housing	125 mm	125 mm	125 mm	125 mm
Depth of the housing	121 mm	121 mm	121 mm	121 mm
Installation width	70 mm	70 mm	164 mm	244 mm
Mounting height	225 mm	225 mm	225 mm	225 mm
Weight, approx.	0.6 kg	0.8 kg	2.2 kg	2.9 kg
Product feature of the housing / housing that can be lined up next to one another	Yes			
Type of mounting / rail mounting	Yes			
Mounting	Can be snapped onto standard EN 60715 35x7,5/15 mounting rails			Can be snapped onto standard EN 60715 35x15 mounting rails

## 6.8 Accessories

	<b>6EP1333-3BA10 (24 V/5 A)</b> <b>6EP1334-3BA10 (24 V/10 A)</b>	<b>6EP1336-3BA00 (24 V/20 A)</b> <b>6EP1337-3BA00 (24 V/40 A)</b>
Electrical accessories	Redundancy module, buffer module	Redundancy module, buffer module, signaling module

## 6.9 Dimension drawing

See Section Dimensions and weight (Page 18)

CAD data that can be downloaded from the Internet:

6EP1333-3BA00

([http://www.automation.siemens.com/bilddb/index.aspx?objKey=G\\_KT01\\_XX\\_00581](http://www.automation.siemens.com/bilddb/index.aspx?objKey=G_KT01_XX_00581))

6EP1334-3BA00

([http://www.automation.siemens.com/bilddb/index.aspx?objKey=G\\_KT01\\_XX\\_00442](http://www.automation.siemens.com/bilddb/index.aspx?objKey=G_KT01_XX_00442))

6EP1336-3BA00

([http://www.automation.siemens.com/bilddb/index.aspx?objKey=G\\_KT01\\_XX\\_00578](http://www.automation.siemens.com/bilddb/index.aspx?objKey=G_KT01_XX_00578))

6EP1337-3BA00

([http://www.automation.siemens.com/bilddb/index.aspx?objKey=G\\_KT01\\_XX\\_00562](http://www.automation.siemens.com/bilddb/index.aspx?objKey=G_KT01_XX_00562))

## Safety, approvals, EMC

### 7.1 Safety

	6EP1333-3BA10 (24 V/5 A) 6EP1334-3BA10 (24 V/10 A) 6EP1336-3BA00 (24 V/20 A) 6EP1337-3BA00 (24 V/40 A)
Primary/secondary galvanic isolation	Yes
Galvanic isolation	SELV output voltage $U_a$ according to EN 60950-1 and EN 50178
Protection class	Class I
Degree of protection (EN 60529)	IP20
Leakage current, typ.	1 mA
Leakage current, max.	3.5 mA
Test voltage	See Table 7-1 Test voltages for 6EP1333-3BA10 and 6EP1334-3BA10 (Page 52) and Table 7-2 Test voltages for 6EP1336-3BA00 and 6EP1337-3BA00 (Page 53)

## 7.2 Test voltage

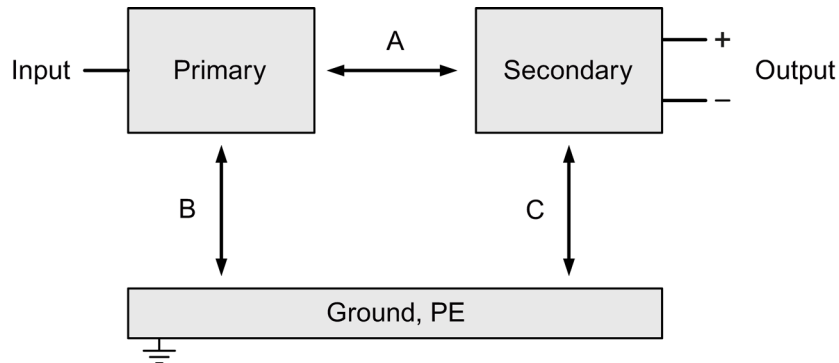

Figure 7-1 Test voltage diagram

Only the manufacturer can perform the type test and production test; users can also perform the field test.

Preconditions for performing the field test:

Tests (A) & (B)

- Connect the input terminals with one another
- Connect the output terminals with one another

Test (C)

- Connect the output terminals with one another and measure against PE

Table 7- 1 Test voltages for 6EP1333-3BA10 and 6EP1334-3BA10

	Test time	Prim ↔ sec (A)	Prim ↔ PE (B)	Sec ↔ PE (C)
Type test	60 s	4200 VDC	2200 VDC	700 VDC
	60 s	3000 VAC	1500 VAC	500 VAC
Production test	1 s	4200 VDC	4200 VDC	500 VDC
	1 s	3000 VAC	3000 VAC	350 VAC
Field test	1 s	2200 VDC	2200 VDC	500 VDC
	1 s	1500 VAC	1500 VAC	350 VAC

Remark:

Tripping current for DC measurement: 0 mA

Tripping current for AC measurement: <100 mA

Table 7- 2 Test voltages for 6EP1336-3BA00 and 6EP1337-3BA00

	Test time	Prim ↔ sec (A)	Prim ↔ PE (B)	Sec ↔ PE (C)
Type test	60 s	4200 VDC	2200 VDC	700 VDC
	60 s	3000 VAC	1500 VAC	500 VAC
Production test	1 s	2200 VDC	2200 VDC	500 VDC
	1 s	1500 VAC	1500 VAC	350 VAC
Field test	1 s	2200 VDC	2200 VDC	500 VDC
	1 s	1500 VAC	1500 VAC	350 VAC

Remark:

Tripping current for DC measurement: 0 mA

Tripping current for AC measurement: <100 mA

## 7.3 Approvals

	<b>6EP1333-3BA10 (24 V/5 A)</b>	<b>6EP1336-3BA00 (24 V/20 A)</b>	<b>6EP1337-3BA00 (24 V/40 A)</b>
	<b>6EP1334-3BA10 (24 V/10 A)</b>		
CE marking	Yes, (2004/108/EG and 2006/95/EG)		
UL/cUL (CSA) approval	cULus-Listed (UL 508, CSA C22.2 No. 107.1), File E197259		
cCSoff	UL 60950-1, CSA C22.2 No. 60950-1		
Explosion protection	Ex II 3G Ex nA nC IIC T3 Gc CSA C22.2 No. 213 Class I, Div 2, GROUPS A, B, C, D, T3 ANSI/ISA-12.12.01		
CB approval	Yes	No	No
SEMI F47 compliance	Fulfilled		
Marine approvals	GL, ABS	GL, ABS	-

## 7.4 EMC

		<b>6EP1333-3BA10 (24 V/5 A)</b>	<b>6EP1334-3BA10 (24 V/10 A)</b>	<b>6EP1336-3BA00 (24 V/20 A)</b>	<b>6EP1337-3BA00 (24 V/40 A)</b>
Electrostatic discharge	EN 61000-4-2	8 kV contact, 8 kV air			
Electromagnetic fields	EN 61000-4-3	80 ...1000 MHz 25 V/m 1000 ...2700 MHz 10 V/m			
High-speed transient disturbance variables (burst)	EN 61000-4-4	4 kV at line supply connections 2 kV at the DC output			
Surge voltages	EN 61000-4-5	3 kV symmetrical at the line supply connections 6 kV symmetrical at the line supply connections 500 V symmetrical/asymmetrical on DC output cables			
High-frequency fields	EN 61000-4-6	10 V; 0.15...80 MHz			
Magnetic fields	EN 61000-4-8	30 A/m; 50 Hz			
Emitted interference	EN 55022	Class B			
Line harmonics limitation	EN 61000-3-2	Class A			
Generic standards	EN61000-6-2	Immunity for industrial environments			
	EN61000-6-3	Emission for residential areas			

## Ambient conditions

	6EP1333-3BA10 (24 V/5 A) 6EP1334-3BA10 (24 V/10 A)	6EP1336-3BA00 (24 V/20 A) 6EP1337-3BA00 (24 V/40 A)
Ambient temperature	-25 ... +70 °C with natural convection	0 ... +70° C with natural convection
	Tested according to: <ul style="list-style-type: none"> <li>• EN 60068-2-1 cold</li> <li>• EN 60068-2-2 dry heat</li> <li>• EN 60068-2-78 humid heat, constant</li> <li>• EN 60068-2-14 temperature change</li> </ul>	
Transport and storage temperature	-40 ... +85° C	
	Tests (packed for shipping) according to: <ul style="list-style-type: none"> <li>• EN 60068-2-1 cold</li> <li>• EN 60068-2-2 dry heat</li> <li>• EN 60068-2-30 humid heat, cyclic</li> </ul>	
Humidity class	Climatic class 3K3 according to EN 60721, without condensation	
Mechanical stressing during operation	Tested according to: <ul style="list-style-type: none"> <li>• EN 60068-2-6 Vibration, test Fc: 0.075 mm deflection in the range 10 – 58 Hz 1 g acceleration in the range 58 – 150 Hz</li> <li>• EN 60068-2-27 shock, test Ea: acceleration 150 m/s<sup>2</sup> , test duration 11 ms</li> </ul>	
Damaging gases	Tested according to: <ul style="list-style-type: none"> <li>• EN 60068-2-42 sulfur dioxide</li> <li>• EN 60068-2-43 hydrogen sulfide</li> </ul>	
Atmospheric pressure	Operation: <ul style="list-style-type: none"> <li>• 1080 ... 795 hPa (-1000 ... +2000 m)</li> <li>• For operation at altitudes of 2000 m up to 6000 m above sea level: output must be derated by -7.5% / 1000 m or the ambient temperature must be reduced by 5 K / 1000 m see Figure 4-5 Mounting height derating (Page 24)</li> <li>• Overvoltage category: III to 2000 m (EN 50178) II from 2000 m to 6000 m (EN 50178) II to 2000 m (EN 60950-1) I from 2000 m to 6000 m (EN 60950-1)</li> </ul> Storage: <ul style="list-style-type: none"> <li>• 1080 ... 660 hPa (-1000 ... +3500 m)</li> </ul>	





## Applications

### 9.1 Parallel connection to increase power rating

To increase the power rating, SITOP modular power supplies of the same type can be directly connected in parallel.

The following must be observed:

- The cables connected to each power supply at terminals "+" and "-" must have identical lengths and the same cable cross-sections (or the same impedance) up to a common external connection point (terminal strip) if possible.
- The power supplies connected in parallel must be switched on simultaneously with a common switch in the line feeder cable (e.g. with the main switch available in control cabinets).
- The output voltages measured in no-load operation for the power supplies that are not yet connected in parallel should not deviate more than a maximum of 50 mV. This usually corresponds to the factory setting. If the output voltage is changed, you should connect the "-" terminals and then, in no-load operation, measure the voltage difference between the "+" terminals that have not yet been connected. The voltage difference should not exceed 50 mV.
- Switch change-over switch "A" (see Figure 2-8 Voltage selector switch (example, 6EP1334-3BA10) (Page 15)) to "Parallel operation".

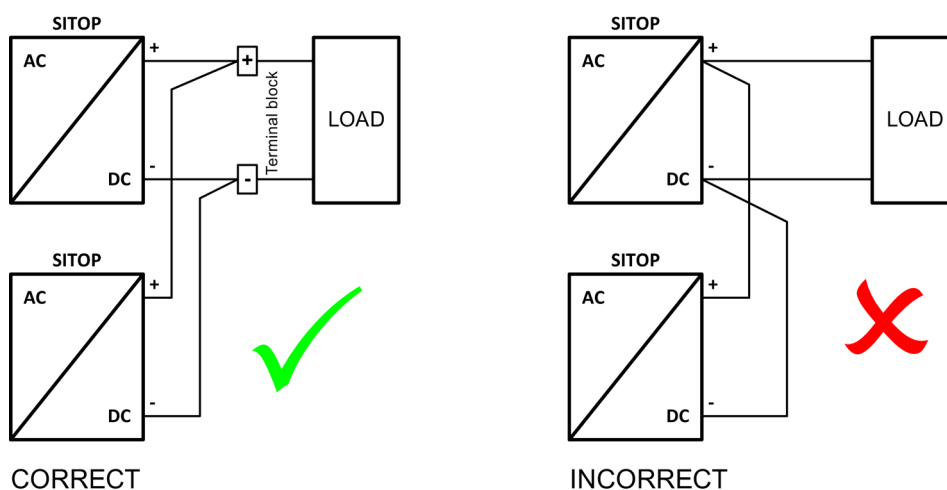

Figure 9-1 Parallel connection

**NOTICE**

**Protective circuit for the parallel connection of more than two power supplies**

For connection of more than two power supplies in parallel, additional measures must be taken to prevent high backward feeding currents in the event of a secondary device fault. For this purpose, a suitable protective circuit (e.g. decoupling diode or DC-conform circuit-breaker) must be installed between each "+" terminal of the power supply and the common connection point.

## 9.2 Parallel connection for redundancy

Connecting several SITOP modular power supplies in parallel for redundancy purposes is required if especially high demands are placed regarding the availability of a reliable 24 V power supply.

Using the SITOP PSE202U redundancy module, two 24 V power supplies of the same type up to 20 A can be decoupled (Figure 9-2 Redundant configuration with two power supplies and SITOP PSE202U redundancy module (Page 59)). When one of the devices fails, then the other automatically takes over the power supply. If one of the power supplies fails, then this is signaled using an LED on the redundancy module as well as an isolated relay contact. For higher output currents, a redundancy module must be connected to each power supply (Figure 9-3 Redundant configuration with two power supplies and two SITOP PSE202U redundancy modules (Page 60)).

When dimensioning the system, it must be ensured that  $n+1$  redundant connected power supplies can handle the total power requirement of the remaining  $n$  power supplies.

---

### Note

For a high reliability of the supply, it is recommended that the redundant switched power supplies are fused separately on the line-side and, if possible, connected to different power supply networks.

---

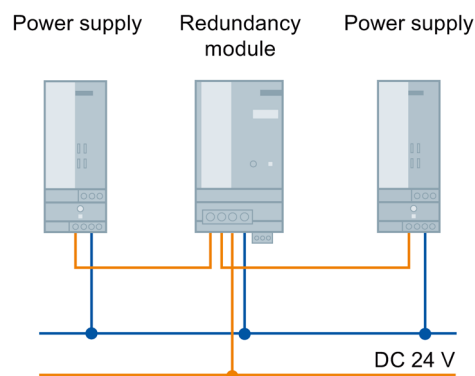

Figure 9-2 Redundant configuration with two power supplies and SITOP PSE202U redundancy module

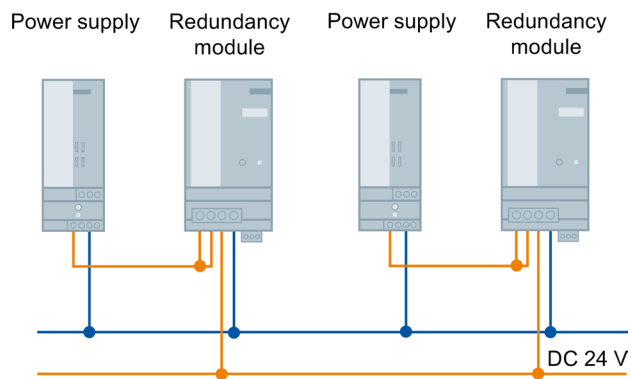

Figure 9-3 Redundant configuration with two power supplies and two SITOP PSE202U redundancy modules

You can find additional information at:

SITOP PSE202U manual (<http://support.automation.siemens.com/WW/view/en/42248598>)

## 9.3 Series connection for increased voltage

To achieve an output voltage of 48 VDC, two 24 V SITOP modular power supplies of the same type can be connected in series. In this case, connect the "-" terminal of the first power supply to the "+" terminal of the second power supply. The "+" terminal of the first power supply and the "-" terminal of the second power supply are routed to the load.

Depending on the grounding point of the secondary output voltages, voltages of +48 V,  $\pm 24$  V or -48 V can be realized.

In the case of an asymmetric load distribution, it is not possible to guarantee correct functionality.

### WARNING

#### SELV is not guaranteed in the case of a fault

When connecting two power supplies in series, the continuous, permissible SELV voltage of a maximum of 60 VDC according to EN 60950 cannot be guaranteed in the case of a fault.

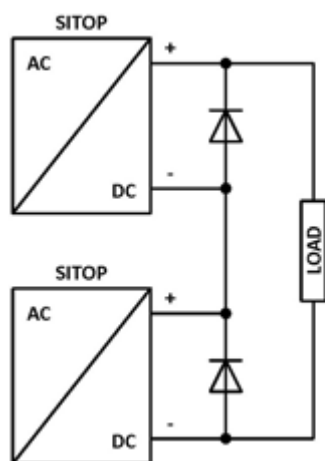

Figure 9-4 Series connection

## 9.4 Overload protection in the 24 V output circuit

If an overload occurs, the electronic current limiting function limits the SITOP modular output current to a maximum value (refer to Chapter Technical data (Page 37)). The output cables are protected against a thermal overload if they are dimensioned corresponding to the maximum rms output current, or protected using additional components (for example, miniature circuit breaker, fuses).

However, a load circuit that fails as a result of overload, for instance, should frequently be reliably and quickly identified and specifically switched off before the power supply goes into current-limiting mode (in current-limiting mode, the supply voltage would also be reduced for all of the remaining 24 V loads).

The SITOP PSE200U selectivity module with 4 channels (versions with adjustable output current range for each channel from 0.5-3 A and 3-10 A) is available; this monitors the 24 V branches for overloading and short-circuiting (Figure 9-5 Electronic protection of 24 V loads using the SITOP PSE200U selectivity module (Page 62)). Brief current peaks, e.g. as a result of a high inrush current, are permitted, and branches with a longer overload are switched into a no-current condition. This is also ensured for cables in a high-ohmic condition and for short-circuits that slowly develop over time.

When a channel fails, the fault is signaled using a group signal contact or as a single channel signal, and the branch of the module involved is displayed using an LED.

For versions with single-channel signaling, function blocks for evaluation purposes are available at no charge for SIMATIC S7-1200/1500/300/400, for STEP 7 and TIA Portal as well as for SIMOTION CPUs and SIMOTION SCOUT.

You can find additional information at:

SITOP PSE200U selectivity module manuals  
(<http://support.automation.siemens.com/WW/view/en/10807226/130000>)

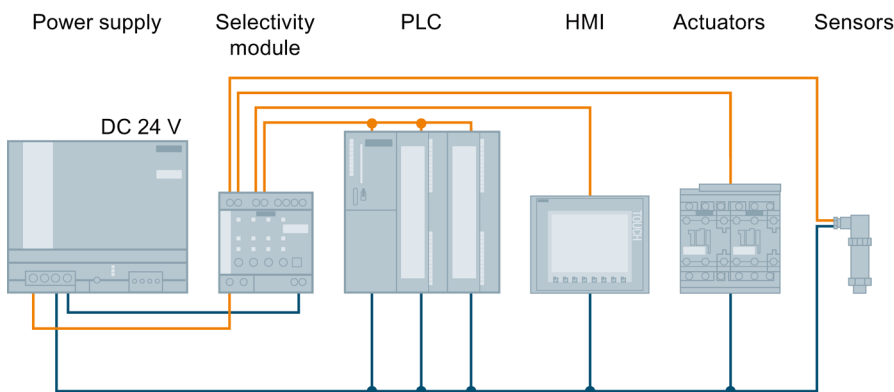

Figure 9-5 Electronic protection of 24 V loads using the SITOP PSE200U selectivity module

## 9.5 Protection against short-time voltage dips

For a drop in the line-side supply voltage, the SITOP modular power supply still maintains the output voltage for a short time in the millisecond range (see Chapter Technical data (Page 37)).

For line supplies that manifest frequent brief voltage dips, in order to increase the power supply reliability, it may make sense to increase the line buffering time in the device using an additional SITOP PSE201U buffer module.

The SITOP PSE201U buffer module, based on electrolytic capacitors, is connected in parallel to the 24 V power supply output (Figure 9-6 Buffering brief power failures using the SITOP PSE201U buffer module (Page 63)). The buffer time is 200 ms at 40 A up to 1.6 s for a load current of 5 A. This time can be increased a multiple number of times by connecting buffer modules in parallel; the maximum buffer time is 10 s.

You can find additional information at:

SITOP PSE201U manual (<http://support.automation.siemens.com/WW/view/en/41129219>)

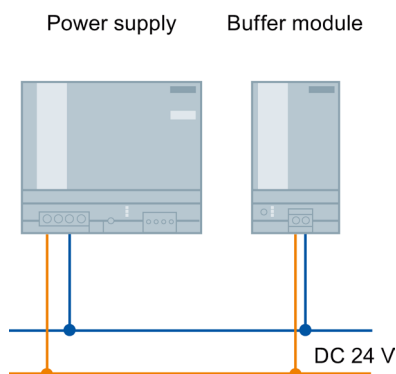

Figure 9-6 Buffering brief power failures using the SITOP PSE201U buffer module

## 9.6 Protecting against longer power failures

Sudden and longer failures of the line supply voltage can result in undefined states and significant danger as a result of the associated failure of the plant or system control. The SITOP power supply product portfolio includes various DC-UPS solutions to prevent the failure of the 24 V power supply voltage.

Power supply failures up into the minutes range can be buffered using the maintenance-free SITOP UPS500 DC-UPS modules based on capacitors (Figure 9-7 24 V buffering to allow the saving of process data and controlled shutdown of PCs (Page 64)).

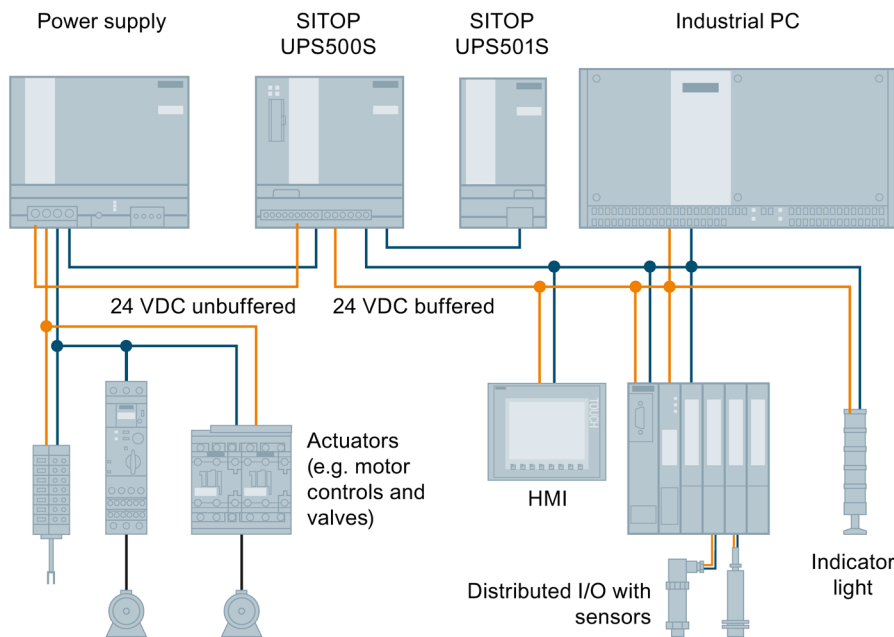

Figure 9-7 24 V buffering to allow the saving of process data and controlled shutdown of PCs

Using the free-of-charge SITOP DC-UPS software tool, DC-UPS systems can be simply integrated into PC-based automation solutions. This supports further processing of the status signals and safely running down the PC.

You can find additional information at:

DC UPS with capacitors manual

<http://support.automation.siemens.com/WW/view/en/48932766/133300>



Using DC UPS SITOP UPS1600 and SITOP UPS1100 battery modules, buffer times in the range of hours can be implemented. Intelligent battery management using Energy Storage Link automatically detects the UPS1100 energy storage device, and ensures optimum temperature-controlled charging and continuous monitoring. The UPS1600 can be flexibly integrated into the widest range of automation applications with its digital inputs/outputs as well as optional USB interface or Ethernet/PROFINET port.

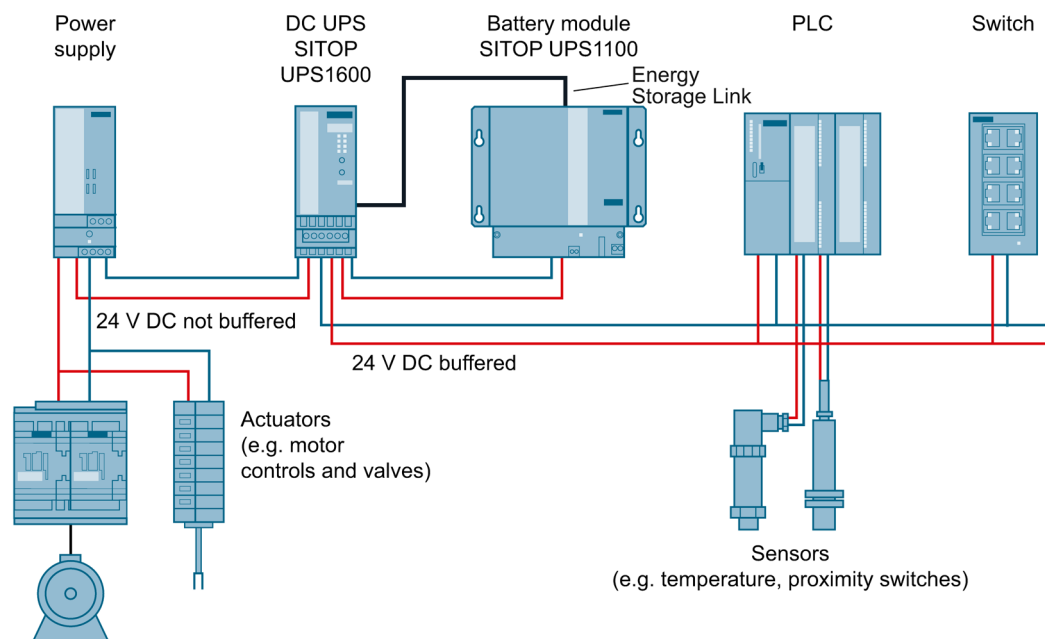

Figure 9-8 24 V buffering with SITOP UPS1600 to maintain communication, signaling functions, sensor measured values and position values

For open, PC-based automation systems, configuration and monitoring is realized using the SITOP UPS Manager PC software, which is available at no charge. This allows PC responses to the operating states of the DC UPS to be freely selected – and offers comprehensive diagnostic functions.

For TIA-based automation systems, the UPS1600 is engineered using the TIA Portal. Special function blocks for SIMATIC S7-300/400/1200 and S7-1500 – available at no charge – make it easy to integrate operating and diagnostics information into STEP 7 user programs. Preconfigured UPS faceplates for WinCC visualization can be downloaded at no charge.

You can find additional information at:

DC UPS SITOP UPS1600/UPS1100 Manual

(<http://support.automation.siemens.com/WW/view/en/84977415>)



## Environment

The devices are in conformance with RoHS.

As a rule, only non-silicon precipitating materials are used.

### Disposal guidelines



Packaging and packaging aids can and should always be recycled. The product itself may not be disposed of as domestic refuse.



## Service & Support

### Technical support

Technical support for all IA/DT products can be accessed through the following communication channels:

- Phone: + 49 (0) 911 895 7222
- E-Mail (<mailto:support.automation@siemens.com>)
- Internet:  
Online support request form (<http://www.siemens.de/automation/support-request>)

### Technical documentation on the Internet

Operating instructions and manuals for SITOP are available in the Internet:  
Operating instructions/manuals (<http://www.siemens.de/sitop/manuals>)

### SITOP power supply homepage

General news about our power supplies is available in the Internet at the SITOP homepage:  
SITOP (<http://www.siemens.de/sitop>)

### Information material

SITOP information can be downloaded from the Internet:  
Information and download center (<http://www.siemens.de/sitop-infomaterial>)

### CAX data

2D/3D data and circuit diagram macros can be downloaded from the Internet:  
Siemens image database (<http://www.siemens.de/sitop-cax>)

Request all CAX data via the CAX download manager:  
CAX shopping cart (<http://www.siemens.de/cax>)

### SITOP Selection Tool

Simply and quickly select the optimum the power supply or DC-UPS:  
SITOP Selection Tool (<http://www.siemens.de/sitop-selection-tool>)

### Online catalog and ordering system

The online catalog and the online ordering system are available through the Industry Mall homepage:  
Industry Mall (<http://www.siemens.com/industrymall/de>)

**Contact persons**

If you have any questions regarding the use of our products, then contact the Siemens contact person in your regional Siemens sales office.

You can find these addresses as follows:

- On the Internet (<http://www.siemens.de/automation/partner>)
- In Catalog CA 01