

K10F003MCH

Cam ammeter switch, Harmony K, Ø16 or 22mm , plastic, for 3 circuits, position 0, 90°, 10A, 30x30mm, marked 0/1/2/3



Main

Range of Product	Harmony K
Product or Component Type	Complete cam switch
Component name	K10
[I _{th}] conventional free air thermal current	10 A
Product mounting	Front mounting
Fixing Mode	Ø 16 or 22 mm hole
Cam switch head type	With front plate 30 x 30 mm
Type of operator	Black handle
Rotary handle padlocking	Without
Presentation of legend	With metallic, 0 - 1 - 2 - 3 black
Cam switch function	Ammeter switch
Return	Without
Type of Measurement	For 3 circuits
Off position	With Off position
Switching positions	Right: 0° - 90° - 180° - 270°
IP degree of protection	Contact block: IP20 Operating head: IP65 conforming to IEC 60529

Complementary

Switching angle	90 °
[U _i] rated insulation voltage	440 V 3)IEC 60947-1
Rated operational power in W	1800 W AC-23A, 220/240 V 3 phase 370 W AC-23A, 110/120 V 1 phase 750 W AC-23A, 220/240 V 1 phase
Rated power in hp	1 Hp 220/240 V AC, 3 phase 0.33 Hp 110/120 V AC, 1 phase 0.75 Hp 110/120 V AC, 3 phase 0.75 hp 220/240 V AC, 1 phase
[I _e] rated operational current AC	10 A 400 V AC-1 10 A 400 V AC-21A 3 A 240 V AC-15 6 A AC-15
[I _e] rated operational current DC	10 A 24 V resistive 0.3 A 220 V resistive 0.7 A 110 V resistive
Electrical durability	10000000 cycles
Short-circuit protection	10 A cartridge fuse gG
[U _{imp}] rated impulse withstand voltage	4 kV IEC 60947-1
Contact operation	Slow-break
Electrical connection	Captive screw clamp terminals 2 x 1.5 mm ²
Mechanical durability	1000000 cycles
CAD overall width	1.18 in (30 mm)
CAD overall height	1.18 in (30 mm)
CAD overall depth	3.94 in (100 mm)
Net Weight	0.12 lb(US) (0.055 kg)

The information provided in this documentation contains general descriptions and/or technical characteristics of the performance of the products contained herein. This documentation is not intended as a substitute for and is not to be used for determining suitability or reliability of these products for specific user applications. It is the duty of any such user or integrator to perform the appropriate and complete risk analysis, evaluation and testing of the products with respect to the relevant specific application or use thereof. Neither Schneider Electric Industries SAS nor any of its affiliates or subsidiaries shall be responsible or liable for misuse of the information contained herein.

Environment

Standards	CENELEC EN 50013 EN/IEC 60947-3 EN/IEC 60947-5-1
Product certifications	CULus
Protective treatment	TC
Ambient Air Temperature for Operation	-4...131 °F (-20...55 °C)
Ambient Air Temperature for Storage	-40...158 °F (-40...70 °C)
Electrical shock protection class	Class II IEC 60536

Ordering and shipping details

Category	21446-9003 K CAM SWITCHES
Discount Schedule	CS1
GTIN	3389110076769
Returnability	No
Country of origin	AT

Packing Units

Unit Type of Package 1	PCE
Number of Units in Package 1	1
Package 1 Height	1.57 in (4.0 cm)
Package 1 Width	1.61 in (4.1 cm)
Package 1 Length	4.13 in (10.5 cm)
Package 1 Weight	2.54 oz (72.0 g)
Unit Type of Package 2	S02
Number of Units in Package 2	65
Package 2 Height	5.91 in (15.0 cm)
Package 2 Width	11.81 in (30.0 cm)
Package 2 Length	15.75 in (40.0 cm)
Package 2 Weight	11.32 lb(US) (5.135 kg)

Offer Sustainability

California proposition 65	WARNING: This product can expose you to chemicals including: Nickel compounds, which is known to the State of California to cause cancer, and Di-isodecyl phthalate (DIDP), which is known to the State of California to cause birth defects or other reproductive harm. For more information go to www.P65Warnings.ca.gov
REACH Regulation	REACH Declaration
REACH free of SVHC	Yes
EU RoHS Directive	Pro-active compliance (Product out of EU RoHS legal scope) EU RoHS Declaration
Toxic heavy metal free	Yes
Mercury free	Yes
China RoHS Regulation	China RoHS Declaration
RoHS exemption information	Yes
WEEE	The product must be disposed on European Union markets following specific waste collection and never end up in rubbish bins.

Contractual warranty

Warranty	18 months
----------	-----------

Cam Switch

Front Mounting by $\varnothing 16$ mm/0.63 in. or $\varnothing 22$ mm/0.87 in. hole

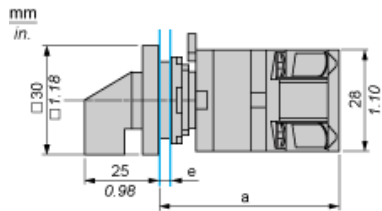

- a 75 mm/2.95 in.
- e support panel thickness: 0.5 mm to 5 mm/0.02 in. to 0.2 in.

Cam Switch

Ø 16 mm/0.63 in. and Ø 22 mm/0.87 in. Panel Cut-outs

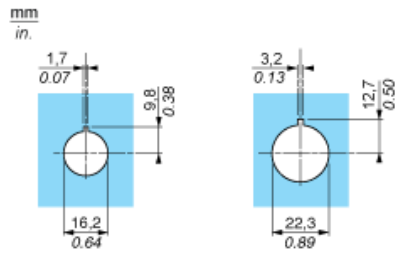

Link Positions (Factory Mounted)

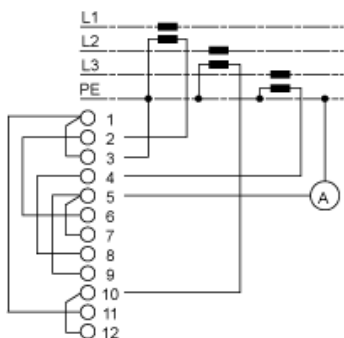

Marking

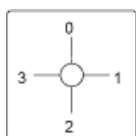

Angular Position of Switch

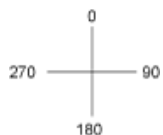

Switching Program

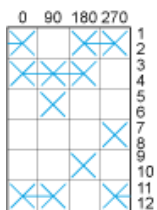

Convention Used for Switching Program Representation

- Contact closed
- Contact closed in 2 positions and maintained between the 2 positions
- Sealed assembly for auto-maintain control
- Overlapping contacts

 Spring return position: for a switching angle of 90°, spring return is over 30° after the last position (for a maximum of 3 simultaneous contacts).

Example:

