



Main

Range of Product	Modicon TM5
Product or Component Type	Analog input module
Analogue input number	2
Analogue input type	Current 0...20 mA differential Voltage +/- 10 V differential
Analogue input resolution	15 bits + sign +/- 10 V 15 bits 0...20 mA

Complementary

Range Compatibility	Modicon LMC058 Modicon M258
Product Compatibility	Logic controller Motion controller
Measurement resolution	305 μ V, +/- 10 V 610 nA, 0...20 mA
Color	White
Input impedance	\geq 20 mOhm voltage
Load impedance ohmic	\leq 400 Ohm current)
Sampling duration	50 μ s
Measurement error	$<$ 0.08 % of full scale +/- 10 V +/- 10 V 25 $^{\circ}$ C $<$ 0.08 % of full scale 0...20 mA 0...20 mA 25 $^{\circ}$ C
Temperature coefficient	0.01 %FS/ $^{\circ}$ C
Non-linearity	$<$ 0.01 %FS voltage $<$ 0.015 %FS current
Type of Cable	Shielded cable
Isolation	500 Vrms AC insulation between channel and bus No insulation between channels
Supply	Internal
[Us] rated supply voltage	24 V DC -15...20 %
Common mode rejection	$>$ 70 dB
Local signalling	1 LED green power supply 1 LED red power supply 2 LEDs green input status
Current consumption	2 mA 5 V DC bus 50 mA 24 V DC input/output
Maximum power dissipation in W	1.21 W
Marking	CE
Net Weight	0.06 lb(US) (0.025 kg)

Environment

Standards	CSA C22.2 No 142 IEC 61131-2 UL 508 CSA C22.2 No 213
Product Certifications	C-tick[RETURN]GOST-R[RETURN]cULus[RETURN]CSA
Ambient air temperature for operation	32...131 °F (0...55 °C) without derating horizontal installation) 32...140 °F (0...60 °C) with derating factor horizontal installation) 32...122 °F (0...50 °C) vertical installation)
Ambient Air Temperature for Storage	-13...158 °F (-25...70 °C)
Relative humidity	5...95 % without condensation
IP degree of protection	IP20IEC 61131-2
Pollution degree	2 IEC 60664
Operating altitude	0...6561.68 ft (0...2000 m)
Storage altitude	0.00...9842.52 ft (0...3000 m)
Vibration resistance	1 gn 8.4...150 Hz DIN rail 3.5 mm 5...8.4 Hz DIN rail
Shock resistance	15 gn 11 ms
Resistance to electrostatic discharge	4 kV on contact IEC 61000-4-2 8 kV in air IEC 61000-4-2
Resistance to electromagnetic fields	0.91 V/m (1 V/m) 2...2.7 GHz IEC 61000-4-3 9.14 V/m (10 V/m) 80...2000 MHz IEC 61000-4-3
Resistance to fast transients	1 kV IEC 61000-4-4 I/O) 1 kV IEC 61000-4-4 shielded cable) 2 kV IEC 61000-4-4 power lines)
Surge withstand	0.5 kV differential mode IEC 61000-4-5 1 kV common mode IEC 61000-4-5
Electromagnetic compatibility	EN/IEC 61000-4-6
Disturbance radiated/conducted	CISPR 11

Ordering and shipping details

Category	22532-M258 PLC
Discount Schedule	PC12
GTIN	3595864074726
Returnability	No
Country of origin	AT

Packing Units

Unit Type of Package 1	PCE
Number of Units in Package 1	1
Package 1 Height	0.79 in (2.000 cm)
Package 1 Width	2.36 in (6.000 cm)
Package 1 Length	4.17 in (10.600 cm)
Package 1 Weight	1.41 oz (40.000 g)
Unit Type of Package 2	S02
Number of Units in Package 2	97
Package 2 Height	5.91 in (15.000 cm)
Package 2 Width	11.81 in (30.000 cm)
Package 2 Length	15.75 in (40.000 cm)
Package 2 Weight	9.43 lb(US) (4.278 kg)

Offer Sustainability

Sustainable offer status	Green Premium product
California proposition 65	WARNING: This product can expose you to chemicals including: Lead and lead compounds, which is known to the State of California to cause cancer and birth defects or other reproductive harm. For more information go to www.P65Warnings.ca.gov
REACH Regulation	REACH Declaration
REACH free of SVHC	Yes
EU RoHS Directive	Pro-active compliance (Product out of EU RoHS legal scope) EU RoHS Declaration
Toxic heavy metal free	Yes
Mercury free	Yes
China RoHS Regulation	China RoHS Declaration
RoHS exemption information	Yes
Environmental Disclosure	Product Environmental Profile
Circularity Profile	End Of Life Information
WEEE	The product must be disposed on European Union markets following specific waste collection and never end up in rubbish bins.
PVC free	Yes

Contractual warranty

Warranty	18 months
----------	-----------

TM5 Slice

Dimensions

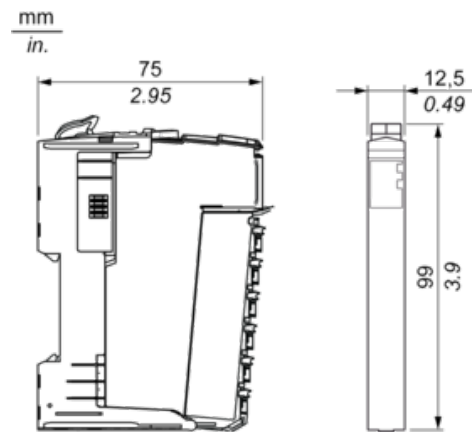

TM5 System

Spacing Requirements

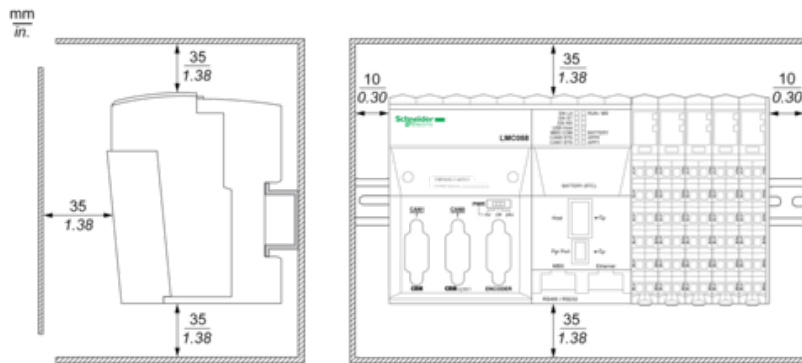



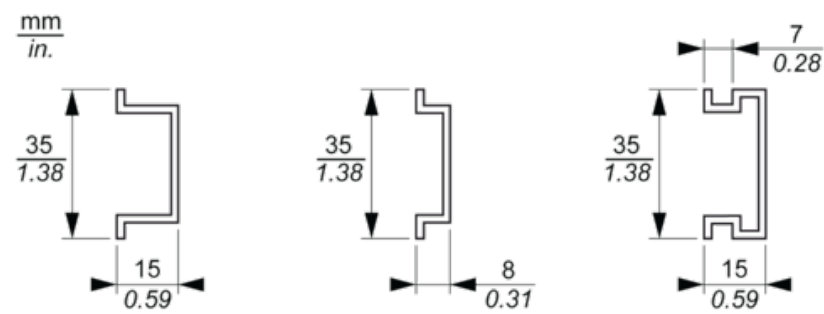

Mounting on a DIN Rail



TM5 System Wiring Recommendations

Wire Sizes to Use with the Removable Spring Terminal Blocks

mm in.					
mm ²		0,08...2,5	0,25...2,5	0,25...1,5	2 x 0,25...2 x 0,75
AWG		28...14	24...14	24...16	2 x 24...2 x 18

Electronic Module 2AI ±10V/0-20mA 16 Bits

Wiring Diagram

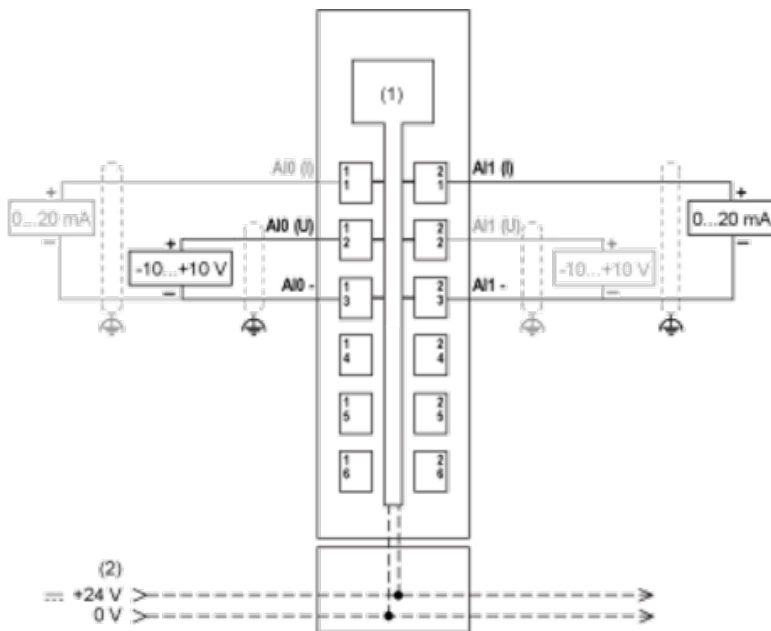

- (1) Internal electronics
- (2) 24 Vdc I/O power segment integrated into the bus bases
- (I) Current
- (U) Voltage

Condition of Installation

Do not place 16-bit analog input modules side-by-side because their electromagnetic characteristics may lead to mutual interference and possible unintended equipment operation. Further, other types of equipments can generate similar electromagnetic interference affecting the conversion accuracy of the modules. In the physical configuration, a single slice of non-interfering equipment is sufficient to avoid this type of disturbance. Separate the 16-bit analog modules from each other and from the following equipment:

- TM5SBER2 Bus receiver
- TM5SPS2 and TM5SPS2F Power Distribution Modules
- TM258... and LMC058... Controllers