

EcoStruxure™ Control Engineering Documentation

User Guide

Original instructions

EIO0000004426.06

11/2023

Legal Information

The information provided in this document contains general descriptions, technical characteristics and/or recommendations related to products/solutions.

This document is not intended as a substitute for a detailed study or operational and site-specific development or schematic plan. It is not to be used for determining suitability or reliability of the products/solutions for specific user applications. It is the duty of any such user to perform or have any professional expert of its choice (integrator, specifier or the like) perform the appropriate and comprehensive risk analysis, evaluation and testing of the products/solutions with respect to the relevant specific application or use thereof.

The Schneider Electric brand and any trademarks of Schneider Electric SE and its subsidiaries referred to in this document are the property of Schneider Electric SE or its subsidiaries. All other brands may be trademarks of their respective owner.

This document and its content are protected under applicable copyright laws and provided for informative use only. No part of this document may be reproduced or transmitted in any form or by any means (electronic, mechanical, photocopying, recording, or otherwise), for any purpose, without the prior written permission of Schneider Electric.

Schneider Electric does not grant any right or license for commercial use of the document or its content, except for a non-exclusive and personal license to consult it on an "as is" basis.

Schneider Electric reserves the right to make changes or updates with respect to or in the content of this document or the format thereof, at any time without notice.

To the extent permitted by applicable law, no responsibility or liability is assumed by Schneider Electric and its subsidiaries for any errors or omissions in the informational content of this document, as well as any non-intended use or misuse of the content thereof.

Table of Contents

Safety Information.....	5
Before You Begin.....	5
Start-up and Test.....	6
Operation and Adjustments.....	7
About the Book.....	8
Introduction to EcoStruxure Control Engineering - Documentation.....	14
Registration, Login, My Account, Licenses and Sessions.....	15
Registration.....	15
Login.....	17
My account Page.....	18
Licenses.....	20
Sessions.....	21
Creating Projects and Programs.....	22
Introduction to Projects and Programs.....	22
Creating Projects and Programs.....	23
Program Creation Wizard.....	25
Accessing a Shared Program.....	28
Sharing Programs with Other Users.....	29
Documenting Controller Applications.....	31
Creating a Documentation of a Controller Application.....	31
Displaying Documentation Code Results.....	32
The Data Flow View.....	35
The Control Flow View.....	39
Downloading an Offline Version of the Documentation.....	43
Limitations of the Free Trial Version.....	44
Manufacturer-Specific File Export Procedures.....	45
EcoStruxure Control Expert (.XEF / .ZEF File Export).....	45
EcoStruxure Machine Expert (.EXPORT File Export).....	46
PL7 Pro (.FEF File Export).....	48
3S CODESYS V3 (.EXPORT File Export).....	49
3S CODESYS V2 (.EXP File Export).....	51
BECKHOFF TwinCAT V3 (.XML File Export).....	53
PHOENIX CONTACT Multiprog v5.5 (.XML File Export).....	54
Rockwell Automation® RSLogix 5000® or Studio 5000 (.L5K File Export).....	55
Siemens SIMATIC STEP 7 (.ASC, .AWL, .GR7 and .SCL File Export).....	56
Siemens TIA Portal SIMATIC STEP 7 (.ZIP File Export).....	65

Safety Information

Important Information

Read these instructions carefully, and look at the equipment to become familiar with the device before trying to install, operate, service, or maintain it. The following special messages may appear throughout this documentation or on the equipment to warn of potential hazards or to call attention to information that clarifies or simplifies a procedure.



The addition of this symbol to a “Danger” or “Warning” safety label indicates that an electrical hazard exists which will result in personal injury if the instructions are not followed.



This is the safety alert symbol. It is used to alert you to potential personal injury hazards. Obey all safety messages that follow this symbol to avoid possible injury or death.

⚠ DANGER
DANGER indicates a hazardous situation which, if not avoided, will result in death or serious injury.

⚠ WARNING
WARNING indicates a hazardous situation which, if not avoided, could result in death or serious injury.

⚠ CAUTION
CAUTION indicates a hazardous situation which, if not avoided, could result in minor or moderate injury.

NOTICE
NOTICE is used to address practices not related to physical injury.

Please Note

Electrical equipment should be installed, operated, serviced, and maintained only by qualified personnel. No responsibility is assumed by Schneider Electric for any consequences arising out of the use of this material.

A qualified person is one who has skills and knowledge related to the construction and operation of electrical equipment and its installation, and has received safety training to recognize and avoid the hazards involved.

Before You Begin

Do not use this product on machinery lacking effective point-of-operation guarding. Lack of effective point-of-operation guarding on a machine can result in serious injury to the operator of that machine.

⚠ WARNING**UNGUARDED EQUIPMENT**

- Do not use this software and related automation equipment on equipment which does not have point-of-operation protection.
- Do not reach into machinery during operation.

Failure to follow these instructions can result in death, serious injury, or equipment damage.

This automation equipment and related software is used to control a variety of industrial processes. The type or model of automation equipment suitable for each application will vary depending on factors such as the control function required, degree of protection required, production methods, unusual conditions, government regulations, etc. In some applications, more than one processor may be required, as when backup redundancy is needed.

Only you, the user, machine builder or system integrator can be aware of all the conditions and factors present during setup, operation, and maintenance of the machine and, therefore, can determine the automation equipment and the related safeties and interlocks which can be properly used. When selecting automation and control equipment and related software for a particular application, you should refer to the applicable local and national standards and regulations. The National Safety Council's Accident Prevention Manual (nationally recognized in the United States of America) also provides much useful information.

In some applications, such as packaging machinery, additional operator protection such as point-of-operation guarding must be provided. This is necessary if the operator's hands and other parts of the body are free to enter the pinch points or other hazardous areas and serious injury can occur. Software products alone cannot protect an operator from injury. For this reason the software cannot be substituted for or take the place of point-of-operation protection.

Ensure that appropriate safeties and mechanical/electrical interlocks related to point-of-operation protection have been installed and are operational before placing the equipment into service. All interlocks and safeties related to point-of-operation protection must be coordinated with the related automation equipment and software programming.

NOTE: Coordination of safeties and mechanical/electrical interlocks for point-of-operation protection is outside the scope of the Function Block Library, System User Guide, or other implementation referenced in this documentation.

Start-up and Test

Before using electrical control and automation equipment for regular operation after installation, the system should be given a start-up test by qualified personnel to verify correct operation of the equipment. It is important that arrangements for such a check are made and that enough time is allowed to perform complete and satisfactory testing.

⚠ WARNING**EQUIPMENT OPERATION HAZARD**

- Verify that all installation and set up procedures have been completed.
- Before operational tests are performed, remove all blocks or other temporary holding means used for shipment from all component devices.
- Remove tools, meters, and debris from equipment.

Failure to follow these instructions can result in death, serious injury, or equipment damage.

Follow all start-up tests recommended in the equipment documentation. Store all equipment documentation for future references.

Software testing must be done in both simulated and real environments.

Verify that the completed system is free from all short circuits and temporary grounds that are not installed according to local regulations (according to the National Electrical Code in the U.S.A, for instance). If high-potential voltage testing is necessary, follow recommendations in equipment documentation to prevent accidental equipment damage.

Before energizing equipment:

- Remove tools, meters, and debris from equipment.
- Close the equipment enclosure door.
- Remove all temporary grounds from incoming power lines.
- Perform all start-up tests recommended by the manufacturer.

Operation and Adjustments

The following precautions are from the NEMA Standards Publication ICS 7.1-1995:

(In case of divergence or contradiction between any translation and the English original, the original text in the English language will prevail.)

- Regardless of the care exercised in the design and manufacture of equipment or in the selection and ratings of components, there are hazards that can be encountered if such equipment is improperly operated.
- It is sometimes possible to misadjust the equipment and thus produce unsatisfactory or unsafe operation. Always use the manufacturer's instructions as a guide for functional adjustments. Personnel who have access to these adjustments should be familiar with the equipment manufacturer's instructions and the machinery used with the electrical equipment.
- Only those operational adjustments required by the operator should be accessible to the operator. Access to other controls should be restricted to prevent unauthorized changes in operating characteristics.

About the Book

Document Scope

The present user guide describes the functionality provided by EcoStruxure Control Engineering - Documentation.

Validity Note

This document has been updated for the release of EcoStruxure Control Engineering V23.2.

Available Languages of this Document

This document is available in these languages:

- English (EIO0000004426)
- French (EIO0000004774)

Related Documents

Title of documentation	Reference number
EcoStruxure Control Engineering - Converter - User Guide	EIO0000004425 (eng) EIO0000004773 (fre)
EcoStruxure Control Engineering - Verification - User Guide	EIO0000004424 (eng) EIO0000004772 (eng)
EcoStruxure Control Engineering - Monitoring - User Guide	EIO0000004427 (eng) EIO0000004775 (fre)
Cybersecurity Best Practices	CS-Best-Practices-2019-340
EcoStruxure Control Engineering, Hardening Guide	EIO0000004982 (eng)

To find documents online, visit the Schneider Electric download center (www.se.com/ww/en/download/).

Product Related Information

▲ WARNING

LOSS OF CONTROL

- Perform a Failure Mode and Effects Analysis (FMEA), or equivalent risk analysis, of your application, and apply preventive and detective controls before implementation.
- Provide a fallback state for undesired control events or sequences.
- Provide separate or redundant control paths wherever required.
- Supply appropriate parameters, particularly for limits.
- Review the implications of transmission delays and take actions to mitigate them.
- Review the implications of communication link interruptions and take actions to mitigate them.
- Provide independent paths for control functions (for example, emergency stop, over-limit conditions, and error conditions) according to your risk assessment, and applicable codes and regulations.
- Apply local accident prevention and safety regulations and guidelines.¹
- Test each implementation of a system for proper operation before placing it into service.

Failure to follow these instructions can result in death, serious injury, or equipment damage.

¹ For additional information, refer to NEMA ICS 1.1 (latest edition), *Safety Guidelines for the Application, Installation, and Maintenance of Solid State Control* and to NEMA ICS 7.1 (latest edition), *Safety Standards for Construction and Guide for Selection, Installation and Operation of Adjustable-Speed Drive Systems* or their equivalent governing your particular location.

▲ WARNING

UNINTENDED EQUIPMENT OPERATION

- Perform a risk assessment as per ISO 12100 and/or other equivalent assessment in view of your use of EcoStruxure Control Engineering.
- In your risk assessment, consider all applicable regulations and standards that apply to your development process and to your machine/process.
- Verify that your use of EcoStruxure Control Engineering is fully covered in the definition of your software development process and that your software development process meets all applicable regulations and standards.
- After modifications of any type whatsoever to the source code of your application resulting from your use of EcoStruxure Control Engineering, commission or recommission the machine/process in compliance with all regulations, standards, and process definitions applicable to your machine/process.
- During commissioning or recommissioning of the machine/process, verify the correct operation and effectiveness of all safety-related functions and non-safety-related functions by performing comprehensive tests for all operating states, for the defined safe state of your machine/process, and for all potential error situations.

Failure to follow these instructions can result in death, serious injury, or equipment damage.

No tool can provide analysis procedures for all potential types of code and methods of creating code. For example, a code block in your source code may be semantically invalid, but syntactically correct. The tool may not be able to detect such a condition.

Software development environments may provide code protection features intended to, for example, block access to intellectual property. Unlock such protected code blocks in your software development environment before creating export files to be used with EcoStruxure Control Engineering.

⚠ WARNING

INCORRECT OR INCOMPLETE SOURCE CODE ANALYSIS

- In your risk assessment, consider all potential effects of inappropriate, incorrect, or incomplete input files used with EcoStruxure Control Engineering.
- Verify that the source code exported from your software development environment and to be used by EcoStruxure Control Engineering is complete and up to date.
- After modifications of any type whatsoever to the source code of your application resulting from your use of EcoStruxure Control Engineering, verify the correctness of the modified source code.

Failure to follow these instructions can result in death, serious injury, or equipment damage.

Machines, controllers, and related equipment are usually integrated into networks. Unauthorized persons and malware may gain access to the machine as well as to other devices on the network/fieldbus of the machine and connected networks because of insufficiently secure access to software and networks.

Schneider Electric adheres to industry best practices in the development and implementation of control systems. This includes a "Defense-in-Depth" approach to secure an Industrial Control System. This approach places the controllers behind one or more firewalls to restrict access to authorized personnel and protocols only.

▲ WARNING
<p>UNAUTHENTICATED ACCESS AND SUBSEQUENT UNAUTHORIZED MACHINE OPERATION</p> <ul style="list-style-type: none"> • Evaluate whether your environment or your machines are connected to your critical infrastructure and, if so, take appropriate steps in terms of prevention, based on Defense-in-Depth, before connecting the automation system to any network. • Limit the number of devices connected to a network to the minimum necessary. • Isolate your industrial network from other networks inside your company. • Protect any network against unintended access by using firewalls, VPN, or other, proven security measures. • Monitor activities within your systems. • Prevent subject devices from direct access or direct link by unauthorized parties or unauthenticated actions. • Prepare a recovery plan including backup of your system and process information. <p>Failure to follow these instructions can result in death, serious injury, or equipment damage.</p>

For more information on organizational measures and rules covering access to infrastructures, refer to ISO/IEC 27000 series, Common Criteria for Information Technology Security Evaluation, ISO/IEC 15408, IEC 62351, ISA/IEC 62443, NIST Cybersecurity Framework, Information Security Forum - Standard of Good Practice for Information Security, and refer to Cybersecurity Guidelines for EcoStruxure Machine Expert, Modicon and PacDrive Controllers and Associated Equipment.

For reasons of Internet security, for those devices that have a native Ethernet connection, TCP/IP forwarding is disabled by default. Therefore, you must manually enable TCP/IP forwarding. However, doing so may expose your network to possible cyberattacks if you do not take additional measures to protect your enterprise. In addition, you may be subject to laws and regulations concerning cybersecurity.

▲ WARNING
<p>UNAUTHENTICATED ACCESS AND SUBSEQUENT NETWORK INTRUSION</p> <ul style="list-style-type: none"> • Observe and respect any and all pertinent national, regional and local cybersecurity and/or personal data laws and regulations when enabling TCP/IP forwarding on an industrial network. • Isolate your industrial network from other networks inside your company. • Protect any network against unintended access by using firewalls, VPN, or other, proven security measures. <p>Failure to follow these instructions can result in death, serious injury, or equipment damage.</p>

Consult the Schneider Electric Cybersecurity Best Practices for additional information.

Information on Non-Inclusive or Insensitive Terminology

As a responsible, inclusive company, Schneider Electric is constantly updating its communications and products that contain non-inclusive or insensitive terminology. However, despite these efforts, our content may still contain terms that are deemed inappropriate by some customers.

Terminology Derived from Standards

The technical terms, terminology, symbols and the corresponding descriptions in the information contained herein, or that appear in or on the products themselves, are generally derived from the terms or definitions of international standards.

In the area of functional safety systems, drives and general automation, this may include, but is not limited to, terms such as *safety*, *safety function*, *safe state*, *fault*, *fault reset*, *malfunction*, *failure*, *error*, *error message*, *dangerous*, etc.

Among others, these standards include:

Standard	Description
IEC 61131-2:2007	Programmable controllers, part 2: Equipment requirements and tests.
ISO 13849-1:2023	Safety of machinery: Safety related parts of control systems. General principles for design.
EN 61496-1:2013	Safety of machinery: Electro-sensitive protective equipment. Part 1: General requirements and tests.
ISO 12100:2010	Safety of machinery - General principles for design - Risk assessment and risk reduction
EN 60204-1:2006	Safety of machinery - Electrical equipment of machines - Part 1: General requirements
ISO 14119:2013	Safety of machinery - Interlocking devices associated with guards - Principles for design and selection
ISO 13850:2015	Safety of machinery - Emergency stop - Principles for design
IEC 62061:2021	Safety of machinery - Functional safety of safety-related electrical, electronic, and electronic programmable control systems
IEC 61508-1:2010	Functional safety of electrical/electronic/programmable electronic safety-related systems: General requirements.
IEC 61508-2:2010	Functional safety of electrical/electronic/programmable electronic safety-related systems: Requirements for electrical/electronic/programmable electronic safety-related systems.
IEC 61508-3:2010	Functional safety of electrical/electronic/programmable electronic safety-related systems: Software requirements.
IEC 61784-3:2021	Industrial communication networks - Profiles - Part 3: Functional safety fieldbuses - General rules and profile definitions.
2006/42/EC	Machinery Directive
2014/30/EU	Electromagnetic Compatibility Directive
2014/35/EU	Low Voltage Directive

In addition, terms used in the present document may tangentially be used as they are derived from other standards such as:

Standard	Description
IEC 60034 series	Rotating electrical machines
IEC 61800 series	Adjustable speed electrical power drive systems
IEC 61158 series	Digital data communications for measurement and control – Fieldbus for use in industrial control systems

Finally, the term *zone of operation* may be used in conjunction with the description of specific hazards, and is defined as it is for a *hazard zone* or *danger zone* in the *Machinery Directive (2006/42/EC)* and *ISO 12100:2010*.

NOTE: The aforementioned standards may or may not apply to the specific products cited in the present documentation. For more information concerning the individual standards applicable to the products described herein, see the characteristics tables for those product references.

Introduction to EcoStruxure Control Engineering - Documentation

Overview

EcoStruxure Control Engineering - Documentation is a reverse engineering tool for controller applications that analyzes the source code and documents controller application information from existing source code. The tool generates an abstract representation of the program in the form of dependency trees and cross-references, to help you to understand the controller application even if you are unfamiliar with the system.

Because the documentation is generated from the source code, it is coherent with the given version of the controller application. Therefore, the tool can provide access to up-to-date program information even if the original paper documentation is out of date.

The documentation generated automatically by the tool includes two dynamic representations of the control program in the form of flow diagrams:

- A control flow for the procedures (call tree)
- A data flow for the variables

These representations support you in, among others, the following tasks:

- Re-documentation: Create a representation of the **structure** of the controller application.
- Design recovery: Support the understanding of the **functionality** of the controller application.

EcoStruxure Control Engineering - Documentation is a Software as a Service (SaaS) tool accessible using a web browser. It is an agnostic tool and supports controller applications written for a variety of controller types and models such as EcoStruxure™ Control Expert (formerly Unity Pro), EcoStruxure™ Machine Expert, PL7-PRO, Siemens TIA Portal, Siemens Simatic Step 7, Rockwell Automation® RSLogix 5000®.

Registration, Login, My Account, Licenses and Sessions

Registration

Overview

The EcoStruxure Control Engineering tools are accessible using the cloud version or using a dedicated server for your organization.

The URL of the cloud version is <https://ecostruxure-control-engineering.se.app/>.

If a dedicated server has been set up for your organization, the URL is available from your system administrator.

In both cases, you must create a user account to use the tools.

Browser Compatibility

The following web browsers are supported:

- Mozilla Firefox from version 11
- Google Chrome from version 16
- Microsoft Edge from version 12
- Microsoft Internet Explorer from version 10
- Apple Safari from version 7

Account Types

The following types of accounts are available:

- For the cloud version: Schneider Electric Account
- For the dedicated server version: EcoStruxure Control Engineering Account

Registration with the Cloud Version

Registration procedure:

Step	Action
1	Go to https://ecostruxure-control-engineering.se.app/ .
2	Click Use a Schneider Electric Account .
3	Click Register .
4	Enter your registration information and complete the registration by following the on-screen instructions.

Registration with the Dedicated Server Version

Registration procedure:

Step	Action
1	In your browser, go to the URL of the dedicated server.
2	Click Sign up .
3	Fill in the form with your first and last names, your phone number, your e-mail address (which is used as your identifier) and select a password. Password requirements: <ul style="list-style-type: none">• At least one uppercase character• At least one lowercase character• At least one numerical character• At least one special character (such as "{", "!", "\$")• Password length between 8 and 32 characters
4	Read the <i>Terms and Conditions</i> and, if you agree, select I agree to the Terms and Conditions .
5	Click Sign Up . Result: A verification e-mail is sent to you.
6	The verification e-mail sent to you contains a link that you need to follow. Result: Your account is activated within a period of 48 working hours.

Contact your system administrator for further details on the registration procedure.

Login

Logging into the Cloud Version Using a Schneider Electric Account

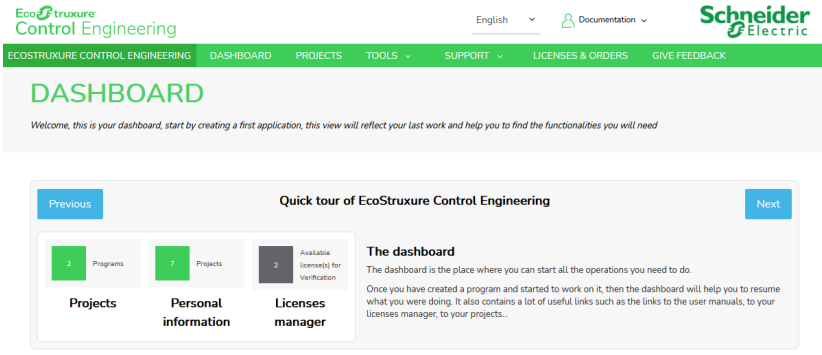
Step	Action
1	When your registration on the Schneider Electric account is completed and your account is ready, go to https://ecostruxure-control-engineering.se.app/ .
2	Click Use a Schneider Electric Account .
3	<p>Enter your email address, click Next and then enter your password.</p> <p>Result: After validation, you are redirected to your dashboard.</p> 

NOTE: If you use an EcoStruxure Control Engineering account but want to migrate to a Schneider Electric account, create a Schneider Electric user account that uses the same email address as your EcoStruxure Control Engineering account. After the first login with a Schneider Electric account, subsequent logins must be completed using your Schneider Electric account. For more information on Schneider Electric accounts, contact your local Schneider Electric service representative.

Logging into the Dedicated Server Version Using an EcoStruxure Control Engineering Account

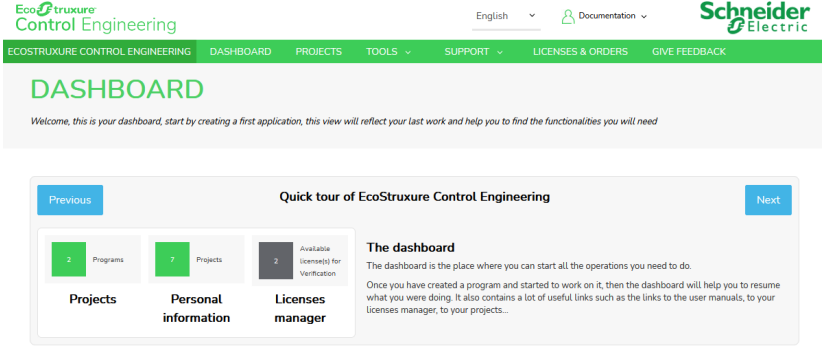
Step	Action
1	In your browser, go to the URL of the dedicated server.
2	Enter your email address and password.
3	<p>Click Login.</p> <p>Result: After validation, you are redirected to your dashboard.</p> 

My account Page

My account Page When Using a Schneider Electric Account

The **My account** page helps you to access the personal information of the account and the global EcoStruxure Control Engineering platform settings.

Step	Action
1	In Dashboard window, click  . Result: A context menu appears.
2	Click My account . Result: My account window appears.

The **Schneider Electric Profile** tab lists the user personal information such as the identity, phone number, country. To update this information, you need to edit your Schneider Electric profile, which is accessible with the link provided in the **Schneider Electric Profile** tab.

The **Third-Party Apps Settings** tab allows you to generate an applicative password to connect your application to EcoStruxure Control Engineering when your application does not support the Schneider Electric account authentication.

From the **Notifications** tab, you can configure the type of email notifications sent to you by the web platform. For example, you can choose to receive a confirmation email at the end of a controller code analysis.

The **View Settings** tab allows you to choose between the different views available on the web platform.

The **Privacy** tab provides general information, actions and instructions about privacy practices and cookies policy. It enables you to understand how private data are used, what are the services that can access it and for which purpose, and to exercise your rights toward the retention and information on your private data.

You can delete the personal information if:

- you are using dedicated server and the server is configured to send the emails.
- you are using cloud version (Not applicable for Monitoring)

My account Page When Using an EcoStruxure Control Engineering Account

The **My account** page helps you to access the personal information of the account and the global EcoStruxure Control Engineering platform settings.

Step	Action
1	In Dashboard window, click  . Result: A context menu appears.
2	Click My account . Result: My account window appears.

The **Profile** tab lists the user personal information such as the identity, phone number, country, etc. You can update this information at any time.

The **Password** tab provides the password change form. You can change your password at any time.

From the **Notifications** tab, you can configure the type of email notifications sent to you by the web platform. For example, you can choose to receive a confirmation email at the end of a controller code analysis.

The **View Settings** tab allows you to choose between different views available on the web platform.

The **Privacy** tab provides general information, actions and instructions about privacy practices and cookies policy. It enables you to understand how private data are used, what are the services that can access it and for which purpose, and to exercise your rights toward the retention and information on your private data.

You can delete the personal information if:

- you are using dedicated server and the server is configured to send the emails.
- you are using cloud version (Not applicable for Monitoring)

Licenses

Overview

Schneider Electric offers various license plans for EcoStruxure Control Engineering tools.

Paid License Plans

Contact your local Schneider Electric representative for details on the available license plans for EcoStruxure Control Engineering tools. A selection of licenses is also directly available from Schneider Electric Exchange at <https://exchange.se.com/shop>.

Free Trial Licenses

As of version 22.1 of EcoStruxure Control Engineering, free trial licenses are available to help you evaluate the EcoStruxure Control Engineering tools after you have created a user account. A trial license allows you to work with many of the functions of the EcoStruxure Control Engineering tool. The number of results provided by the tools and the available functions are limited if you use a trial license. You can upgrade a trial license to a paid license.

Sessions

Automatic Log-Out (Session Time-Out)

After 11 minutes of inactivity in an EcoStruxure Control Engineering session, you are automatically logged out. If you work with multiple browser tabs, the most recent activity in any of the tabs applies. For example, if you work in tab 1, but not in tab 2, tab 2 does not disconnect you because there is activity in tab 1.

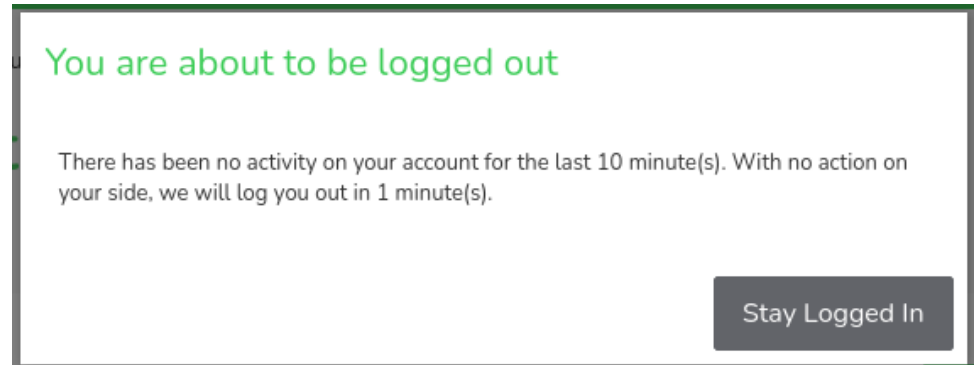

Multiple Sessions

If your credentials are used in multiple sessions, you receive a notification. For example, if you are logged in and another session is established with the same credentials, you receive the following message:

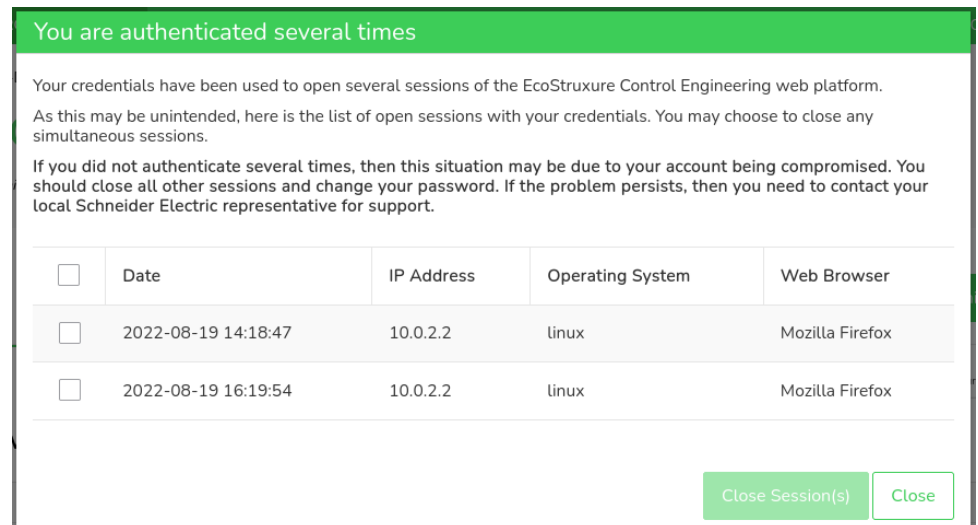

The information on the connection date and time, the IP address, the operating system and browser help you to determine whether or not a sessions is legitimate. You can select and close a session with **Close Session(s)**.

Creating Projects and Programs

Introduction to Projects and Programs

Overview

EcoStruxure Control Engineering provides projects and programs for you to organize your work.

A project is a type of container that can hold programs. A project is not specific to an EcoStruxure Control Engineering tool.

When you register with EcoStruxure Control Engineering, the platform provides one default project for you.

A program is assigned to a project. A program is created in conjunction with one of the tools provided by EcoStruxure Control Engineering. A program typically comprises metadata you entered during its creation, the uploaded source code of a controller application, and the results generated with the EcoStruxure Control Engineering tools.

The EcoStruxure Control Engineering tools are launched from within a program. Whether or not a specific EcoStruxure Control Engineering tool is available for a program depends on the source controller/development environment you select during the creation of the program (**PLC Brand** or **PLC source brand**).

Programs can be shared with other users.

Example

Assume you have been assigned the task of improving a machine ABC with two controllers X and Y. In a first step, you want to better understand the code of the two controller applications. You create a project "Machine ABC". Then you add two programs to this project: "Controller X" and "Controller Y".

In both of these programs, you run EcoStruxure Control Engineering - Documentation to visualize the data flow and the control flow.

In a subsequent step, your task is extended to managing the creation of a new version of the controller applications. You start by running EcoStruxure Control Engineering - Verification in your programs to verify the existing code. You share the two programs with the developers so they can access the results of the code verification for assistance in updating the code.

In subsequent steps, you can upload intermediate versions of the updated code into your program and re-run EcoStruxure Control Engineering - Documentation and EcoStruxure Control Engineering - Verification to document the progress and verify that your coding rules have been properly implemented.

Creating Projects and Programs

Creating Projects

Procedure for creating a project:

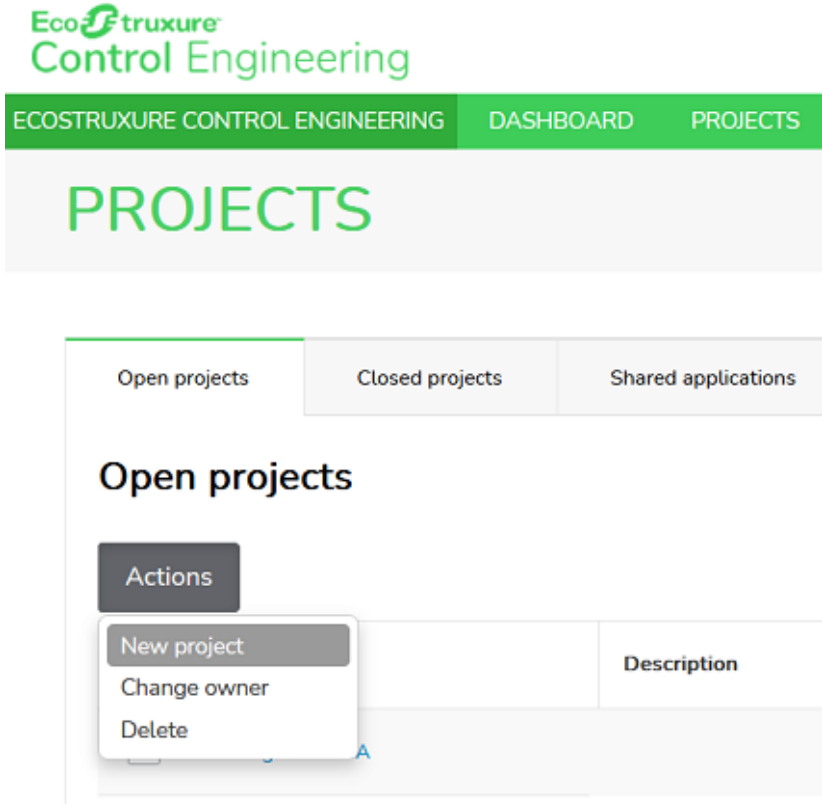
Step	Action
1	Select PROJECTS in the top menu to display the Projects page.
2	Select Actions > New project . 
3	Provide a unique name for your project. Lowercase and uppercase are ignored which means that, for example, the name of a project to be created cannot be "Controller xyz" if you already have a project with the name "Controller XYZ". Click Add to create it.
4	Click Add to create the project. Result: The project is added to your list of projects on the Open projects tab.

Clicking a project in the list displays two tabs. The **Overview** tab provides general information on the project. The **Programs** tab contains the list of programs assigned to this project.

Creating Programs

There are three ways to start the creation of a program:

- From outside of a project select **TOOLS** on the main menu
- From the dashboard click **New ...**
- From inside a project on its **Programs** tab select **Actions > New program**

Creating a program from outside of a project:

Step	Action
1	From the main menu, select TOOLS .
2	Select the tool you want to use for the program. Result: EcoStruxure Control Engineering starts the program creation wizard.

Creating a program from the dashboard:

Step	Action
1	From the main menu, select DASHBOARD .
2	Click the New ... button for the tool you want to use for the program. Result: EcoStruxure Control Engineering starts the program creation wizard.

Creating a program from inside a project:

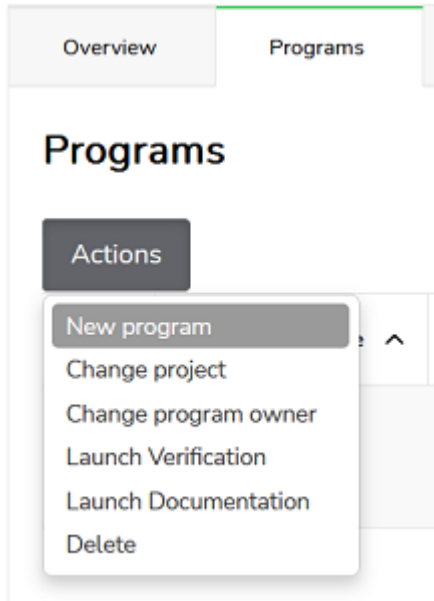
Step	Action
1	From the main menu, select PROJECTS .
2	Select the required project from the list.
3	Display the Programs tab of the project.
4	Select Actions > New program .  <p>Result: EcoStruxure Control Engineering prompts you for the tool to be used for the program and starts the program creation wizard.</p>

Program Creation Wizard

Overview

A wizard guides you through the different steps required to create your program and launch the execution of the selected EcoStruxure Control Engineering tool.

The project to which the new program is assigned depends on how the wizard is started. If the wizard is started from outside of a project or from the dashboard, the program is assigned to your default project. If the wizard started from inside a project, the program is assigned to this project. In both cases, the project assignment can be adjusted in step 1 of the wizard.

Refer to *Creating Programs*, page 23 for details.

Step 1 - Start

The first step consists of providing setup information on the program.

Provide the following information:

- The fields **Application name** and **Customer name** are mandatory. The defined **Application name** is used to identify the program in the different views of EcoStruxure Control Engineering.
- Add additional information in the other fields so that you can identify this program in your project.

Continue with the next step by clicking **Validate And Next Step**.

Step 2 - Parameters

The second step consists of selecting the development environment that was used to develop the controller application.

Select the **PLC Brand** and continue with the next step by clicking **Validate And Next Step**.

Step 3 - License

The third step consists of selecting the EcoStruxure Control Engineering license to be used with your new program.

Please choose how to license this Documentation program, several possibilities are available, you can select each of them to get more information.

Licensing possibilities for this program

- Do not assign a license now
- Use a license ID
- Use a free trial license

Do not assign a license now
Without selecting a license now, you won't be able to run a new Documentation analyse. It is possible to assign a license later, and continue with the program creation process.

Previous Step Validate And Next Step

Chose one of the **Licensing possibilities for this program**:

Licensing possibilities	Description
Do not assign a license now	Select this option when you will not run the analysis immediately.
Use a license ID	Select this option when you have a license code. If you have a license, but the license has not yet been assigned to your user account, you can still use it by entering its identifier in the License #id field.
Use a free trial license	Select this option to launch a trial version of the tool. This is not possible if you have already used all trial licenses that have been associated with your user account.
Use a contract license	This option appears when you have a contract for EcoStruxure Control Engineering. This allows you to automatically generate a license, as part of your contract, to run the analysis.
Use an account license	This option appears when licenses are available in your account. In this case, you can select the license from a dropdown list.

Click **Validate And Next Step** to continue.

If no license is available, you can still continue creating the program by clicking **Validate And Next Step**. In this case, a license can be added to the program after you have created the program. Without a valid license, the EcoStruxure Control Engineering tool selected for this program cannot be executed.

Step 4 - Source file

The fourth step consists of uploading the file with the source code of the controller application that you have exported from the development environment (refer to [Manufacturer-Specific File Export Procedures](#), page 45 for details). This source code is the input material for EcoStruxure Control Engineering. Depending on the EcoStruxure Control Engineering tool used for the program, you may be prompted to upload additional files.

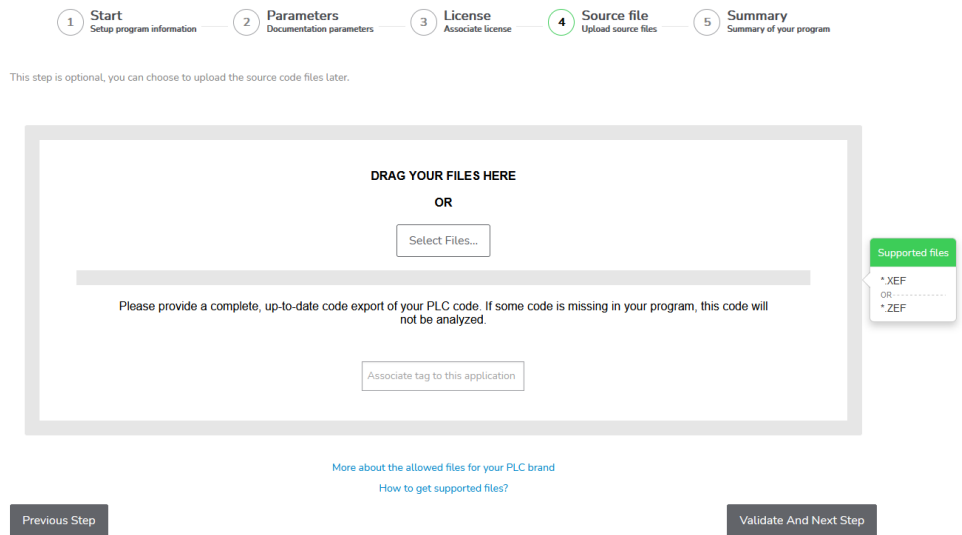

Drag and drop the files to the location indicated or click **Select Files...** to import the files. Then click **Validate And Next Step** to continue.

If the input files are not yet available when you create the program, you can skip the upload with **Validate And Next Step** and provide the files at a later point in time. Without the uploaded input files, the EcoStruxure Control Engineering tool selected for this program cannot be executed.

Step 5 - Summary

The fifth step displays a summary of the information you have provided in creating your program.

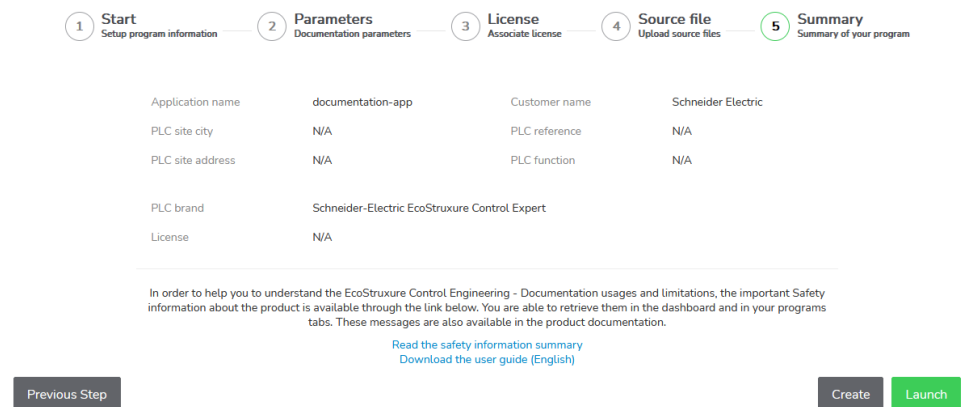

Review the information. If you want to make modifications, click **Previous Step** to return to the step you want to modify.

If the information is correct, click **Create** to create the program or click **Launch** to create the program and to start the EcoStruxure Control Engineering tool selected for this program (this is possible if you have selected a valid license and if you have uploaded the required files).

Accessing a Shared Program

If a program is shared with you, or if access to the program is not restricted (refer to *Sharing a Program*, page 29), you can add it to your list of programs by providing its unique 6-digit key. The unique 6-digit key can be found in the program overview under **Application key**.

Procedure for adding a program to your list of programs using its unique 6-digit key:

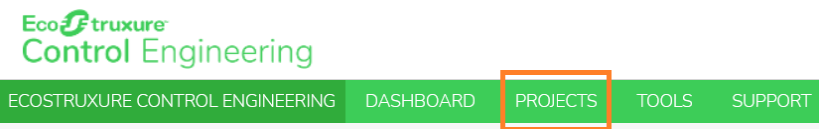
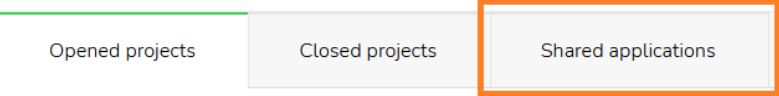
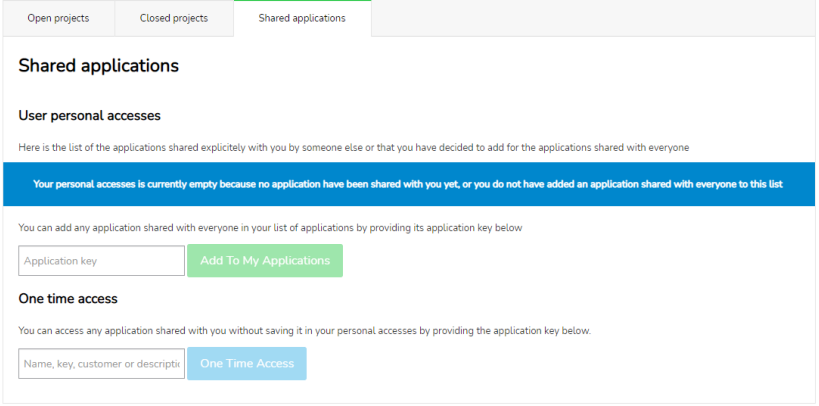
Step	Action
1	<p>From the menu, select PROJECTS to access the Projects page.</p> 
2	<p>Click Shared applications to display the corresponding tab.</p> 
3	<p>Enter the unique 6-digit key of the program in the field below User personal accesses or in the field below One time access, depending on whether you want to add this program to your personal records for access at a later point in time, or whether you want to access it only once without adding it to your list of programs.</p> 
4	<p>Click Add To My Applications or One Time Access.</p>

Sharing Programs with Other Users

Overview

You can share your programs with other users so that a team can work on the same project. As the owner, you can share your program. Selected users with whom you share your program cannot delegate their access rights, that is, they cannot share this shared program with further users.

There are two ways of sharing a program:

- Share with selected users: You choose who can access your program. By default, other users cannot share this program because you are the owner.
- Share with everyone: Everyone can access your program.

Sharing with a Specific User

Procedure for sharing a program with selected users:

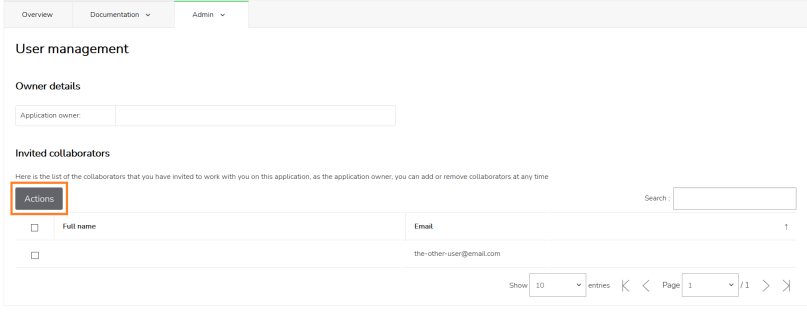
Step	Action
1	Navigate to the Program page.
2	Select Admin > Collaboration > Users access rights to display the User management .
3	Below Invited collaborators , select Actions > Add . 
4	Enter the name and the e-mail address of the user to be invited. You can enter the e-mail address the user specified for registration with EcoStruxure Control Engineering, or you can use any other e-mail address. You can also send an invitation notification to the user. On a dedicated server, the invitation notification function requires a mail server. Users added to the list of invited users can perform the same actions as you, except for sharing the program and modifying its settings. If you do not want invited users to perform any further actions, deactivate the program with the Active application checkbox in Admin > Settings . This sets your program to read-only.

NOTE: If your program uses the EcoStruxure Control Engineering - Verification tool, invited users may not be able to update the rules file and may not be able to work with the Justifications function. Refer to the EcoStruxure Control Engineering - Verification user guide for details.

You can revoke sharing by selecting the user(s) you want to remove from your program and selecting **Actions > Remove access**.

Sharing with Everyone

Procedure for sharing a program with everyone:

Step	Action
1	Navigate to the Program page.
2	Select Admin > Settings .
3	Enable the checkbox Private application . Users accessing your program can perform the same actions as you, except for sharing the program and modifying its settings. If you do not want invited users to perform any further actions, deactivate the program with the Active application checkbox in Admin > Settings . This sets your program to read-only.

NOTE: If your program uses the EcoStruxure Control Engineering - Verification tool, invited users may not be able to update the rules file and may not be able to work with the Justifications function.

You can disable sharing with everybody by deactivating the checkbox **Private application**. With this setting, only users explicitly invited can access your program.

Documenting Controller Applications

Creating a Documentation of a Controller Application

Procedure

No tool can provide analysis procedures for all potential types of code and methods of creating code. For example, a code block in your source code may be semantically invalid, but syntactically correct. The tool may not be able to detect such a condition.

Software development environments may provide code protection features intended to, for example, block access to intellectual property. Unlock such protected code blocks in your software development environment before creating export files to be used with EcoStruxure Control Engineering.

⚠ WARNING
<p>INCORRECT OR INCOMPLETE SOURCE CODE ANALYSIS</p> <ul style="list-style-type: none"> • In your risk assessment, consider all potential effects of inappropriate, incorrect, or incomplete input files used with EcoStruxure Control Engineering. • Verify that the source code exported from your software development environment and to be used by EcoStruxure Control Engineering is complete and up to date. • After modifications of any type whatsoever to the source code of your application resulting from your use of EcoStruxure Control Engineering, verify the correctness of the modified source code. <p>Failure to follow these instructions can result in death, serious injury, or equipment damage.</p>

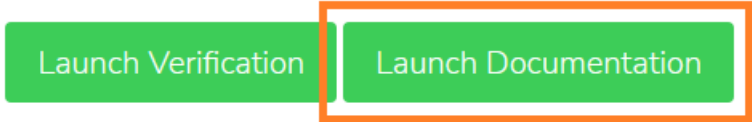
Step	Action
1	Click Launch Documentation on the Program page. <div style="text-align: center; margin-top: 10px;">  </div>
2	Upload the source files of the controller application exported from your software development environment as described in Program Creation Wizard, page 25.
3	Specify the files to be analyzed. If you do not want to generate the documentation for each file, you can remove unwanted files by unselecting them in the list.
4	Start the documentation process by clicking Launch . <p>NOTE: The time required to generate your documentation depends on the size and complexity of the source code of the controller application. Progress information is displayed on the Program page.</p>

Displaying Documentation Code Results

Overview

After you run EcoStruxure Control Engineering - Documentation for the first time, the **Documentation** tab provides access to the dashboard and to the documentation details.

Dashboard

The dashboard provides a summary of the documentation results. To display the dashboard, click **Documentation > Dashboard**.

The dashboard provides various elements, for example, amount of Programmable Organization Units (POUs), variables and communication in your controller application.

Example of a dashboard:

Last analysis details

Current analysis date:	September 20, 2021 16:29:21	First analysis date:	September 20, 2021 16:29:21
Amount of analyzes performed:	1		

Last analysis high-level overview

Here is an overview of your program's last analysis. For a more detailed result, have a look at the specific sections in this page, or consult the corresponding tabs in the Documentation menu entry.

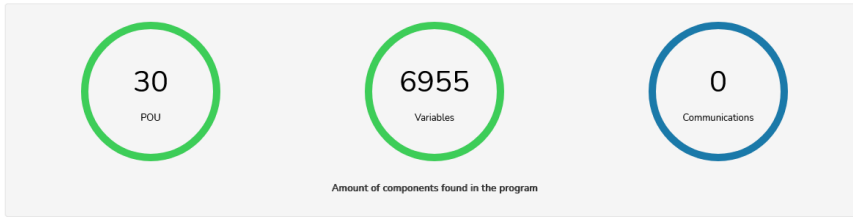

EcoStructure Control Engineering - Documentation helps you to understand your PLC application by highlighting the relations between the components inside it. It can show how the Functions are called by the Tasks for instance, or which variable is used to compute the value of another.

Documentation has been designed to be as easy-to-use as possible, so one can navigate the program using graphs, switching from a variable to another with a simple click. Documentation is also aimed to serve as a backup of your program documentation as you can download a standalone version of the results, or create screenshots to re-use somewhere else of the graphs that matters for you.

POU

Here are some statistics about the POU (Function blocks, Tasks, Functions...) in your PLC program. You can get more information using the interactive graph in the tab "Documentation", entry "Control flow".

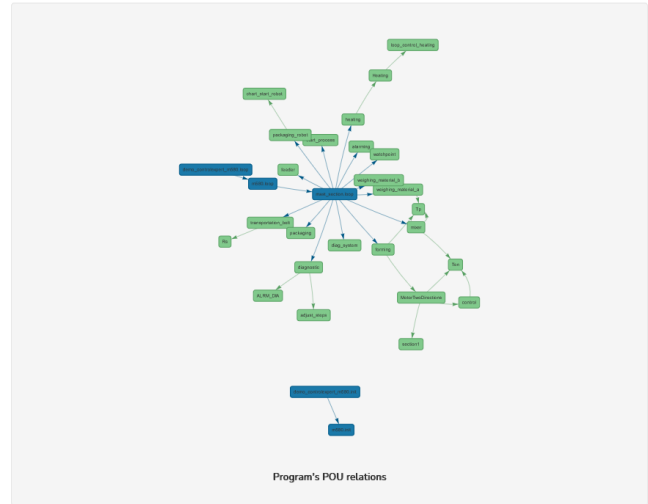
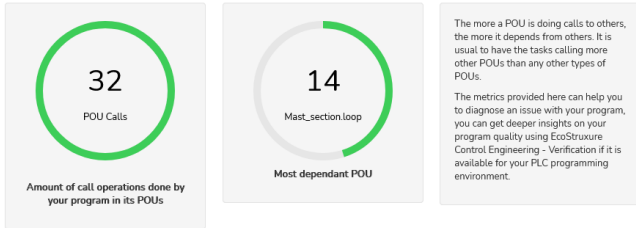

Search:

Name	Language	Amount of dependencies detected	Halstead metrics		
			Cyclomatic Complexity	Statistical amount of bugs	Difficulty
adjust_steps	fbid	0	2	0.0326997	0.5
alarming	list	0	1	0	0
ALRM_DIA	litteral	0	1	0	0
chart_start_robot	grafacet	0	3	0.0576257	2
control	ladder	1	1	0.0393427	1.5
demo_controlexpert_m580.init	litteral	1	1	0	0
demo_controlexpert_m580.loop	litteral	1	1	0	0
diag_system	litteral	0	1	0.0177169	0.5
diagnostic	ladder	2	2	0.0728697	2
feeder	litteral	0	14	0.118953	3.5

Page 1 / 3

Overview of the program's POU's

Variables

Here are some statistics about the variables in your PLC program. You can get more information using the interactive graph in the tab "Documentation", entry "Data flow".

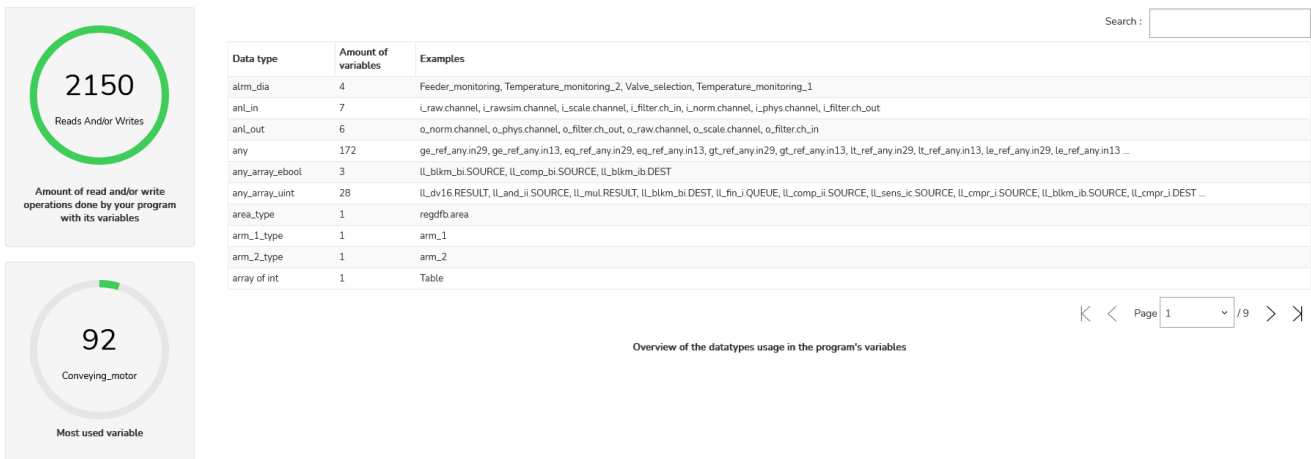

Overview of the datatypes usage in the program's variables

POUs

The term Program Organizational Unit (POU) is used for all programming objects (programs, function blocks, functions, etc.) which are used to create a controller application.

The dashboard displays the total count of programmable entity calls (for instance, if POU1 calls POU3 and POU2 calls POU3, then this counter displays 2) in your controller program.

You can get more information using interactive graphic in the **Documentation > Control flow**. The metrics help you to detect the issue in your program.

Variables

The dashboard displays the total count of variables read and/or write operations detected in your controller application.

You can get more information using interactive graphic in the **Documentation > Data flow**. The metrics help you to detect the issue with your program.

A table is displayed listing the variables by datatype, the amount of variables tagged with this datatype and examples.

Communication

The dashboard displays the total count of the communication (data exchanges between other controller systems) detected in the program.

The Data Flow View

General

The **Data Flow** view displays the relationships between variables of a controller application from input to output, or vice versa.

This view displays how the values of the variables of the controller application are read or written.

Displaying the Data Flow View

If you work with the EcoStruxure Control Engineering platform, select **Documentation > Data flow**.

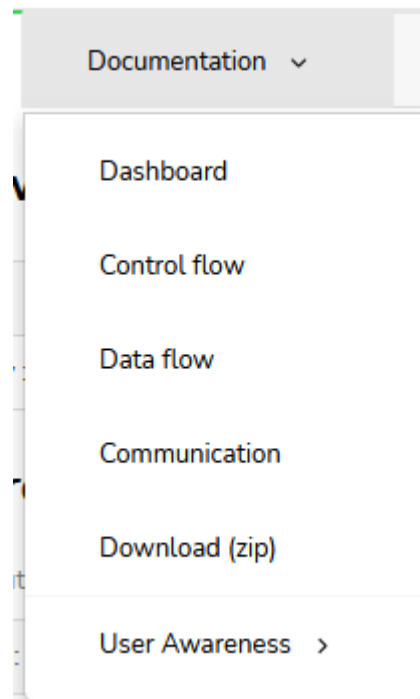

NOTE: If you have downloaded a copy of the online results and want to work with the downloaded copy, open the file **index.html** and click the button **Display Data Flow**. Refer to [Downloading an Offline Version of the Documentation](#), page 43

Overview of the Data Flow View

The Data Flow view consists of four parts:

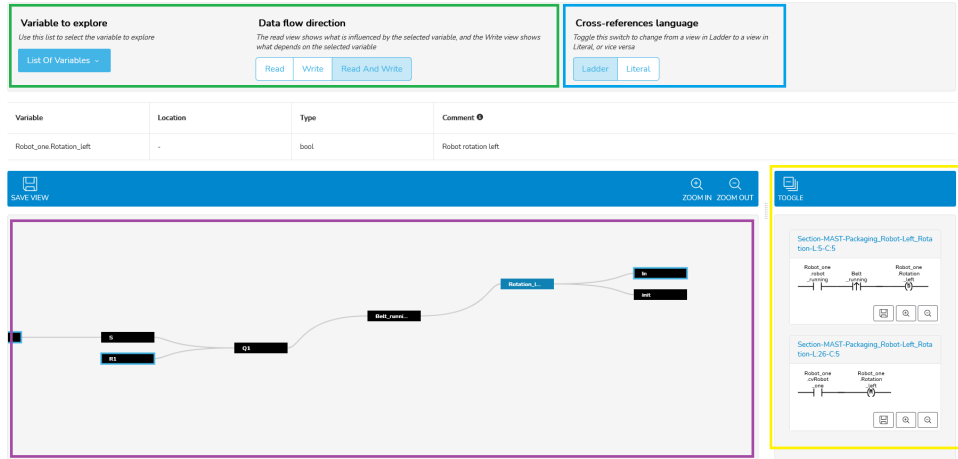

- List of variables to explore and settings for variables (top left, green frame)
- Dependency tree (bottom left, purple frame)
- Language settings (top right, blue frame)
- Cross references snippets (bottom right, yellow frame)

List of Variables

The list of variables to explore lets you select a variable whose dependencies you want to display. Click **List Of Variables** to select a variable.

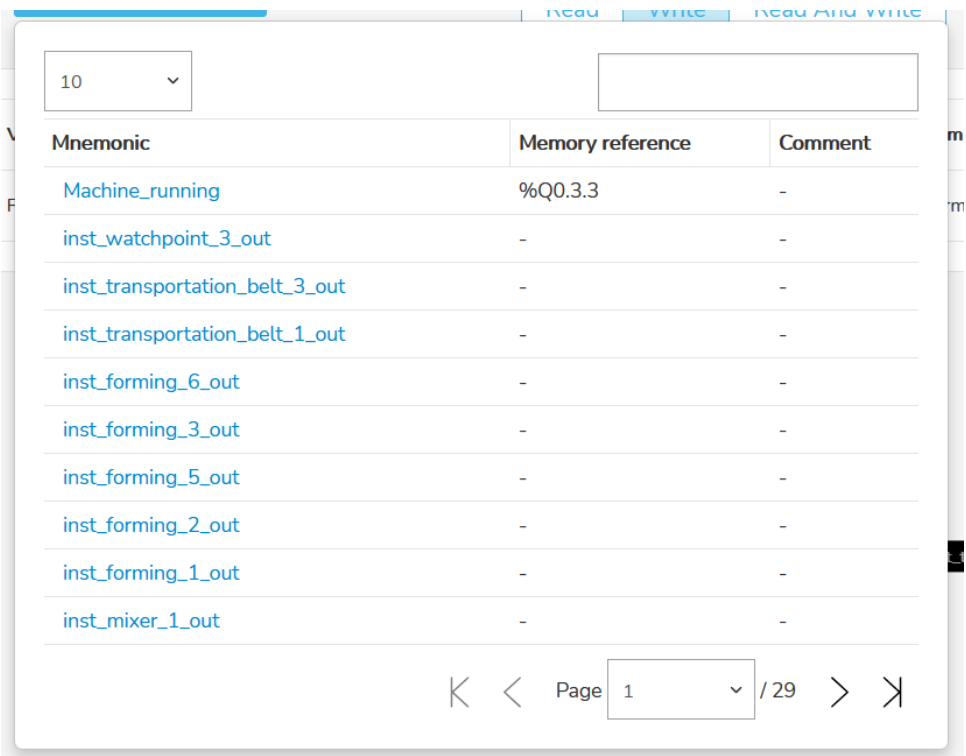

Functions for finding a variable:

- You can scroll through the list using the page buttons at the bottom of the view. You can specify the number of variables to be displayed on a single page using the dropdown list at the top left part of the table.
- You can filter the variables using the search field at the top right part of the list. You can search by full or partial name, address and comment of a variable.

Click the name of a variable to display it in the dependency tree and in the cross references snippets parts of the page.

The **Data flow direction** let you specify the way the dependencies are listed and displayed. **Write** displays only the dependencies that write the value of the variable. **Read** displays only the variables that are used to write to other variables that are using the selected variable. **Read and write** displays both. This selection also affects the way the *Dependency tree*, page 37 is displayed.

The list of variables is not exhaustive in the sense that if a selected variable does not form a dependency (not written to or not used to write to other variables), it will not appear in the list depending on the data flow direction you have chosen.

Dependency Tree

The Dependency tree is a graphical representation of the dependencies between the variables. If a variable is used to compute or to determine another value, this variable is displayed with a link to that other variable.

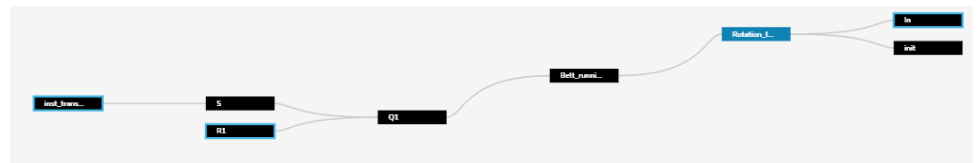

In the example above, the following is true of the selected (blue) variable (**Data flow direction** is set to **Read and write**):

- The variable needs the values of the two linked variables displayed to its left in order to calculate its own value.
- The variable is used to calculate the values of the linked variables displayed to its right.

You can explore the relationships between variables by clicking their names.

This view is helpful to locate the variables affected if code is modified in the controller application, or to determine an unwanted value of a variable in the running controller application.

Language Settings

The language settings let you select **Ladder** or **Literal** as the language for the cross reference snippets.

Depending on the different types of variables, a representation of the code in Ladder may not be available. In such a case, the cross references are displayed in Literal.

Creating a flow chart from a controller application is a complex operation. Depending on the complexity of the code and the different types of objects, EcoStruxure Control Engineering - Documentation may not be able to generate a precise flow if a variable is indexed and/or if its address is accessed indirectly using a variable in the controller application.

Cross References Snippets

The cross references snippets part of the page displays how the variables are used in the calculations of one another.

It consists of a code extract, displayed in Ladder or Literal language, that highlights the relations. The code extract is not displayed in the same way it is written in the original code in order to provide a synthetic view. Its logic still remains the same as in the original code. The logic can be retrieved using the location displayed behind each snippet.

For instance, if you access a variable inside several nested conditional instructions, the snippet compresses these instructions into a single one.

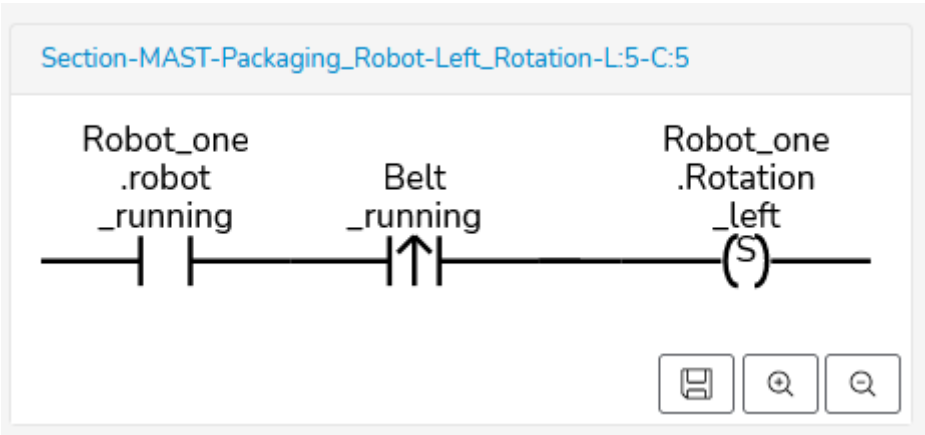

The cross references snippets view is updated each time you select a variable either in the list of variables or in the dependency tree.

The Control Flow View

General

The **Control Flow** view displays the order in which the function or procedure calls are executed or evaluated.

This view displays the way the logic of the controller application is called.

Displaying the Control Flow View

Select **Documentation > Control flow**.

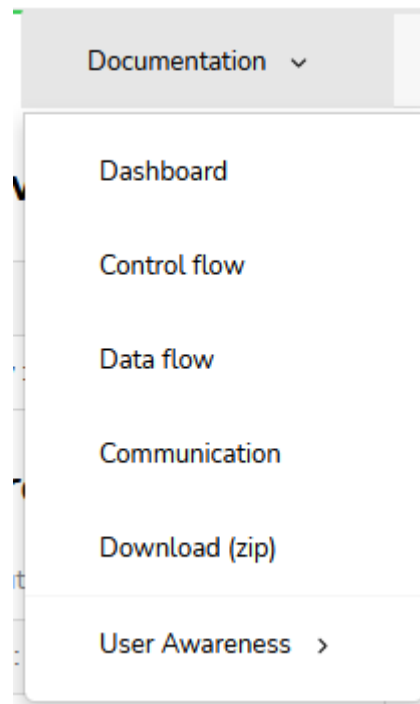

NOTE: If you have downloaded a copy of the online results and want to work with the downloaded copy, open the file **index.html** and click the button **Display Control Flow**. Refer to [Downloading an Offline Version of the Documentation](#), page 43

Overview of the Control Flow View

The Control flow view consists of four parts:

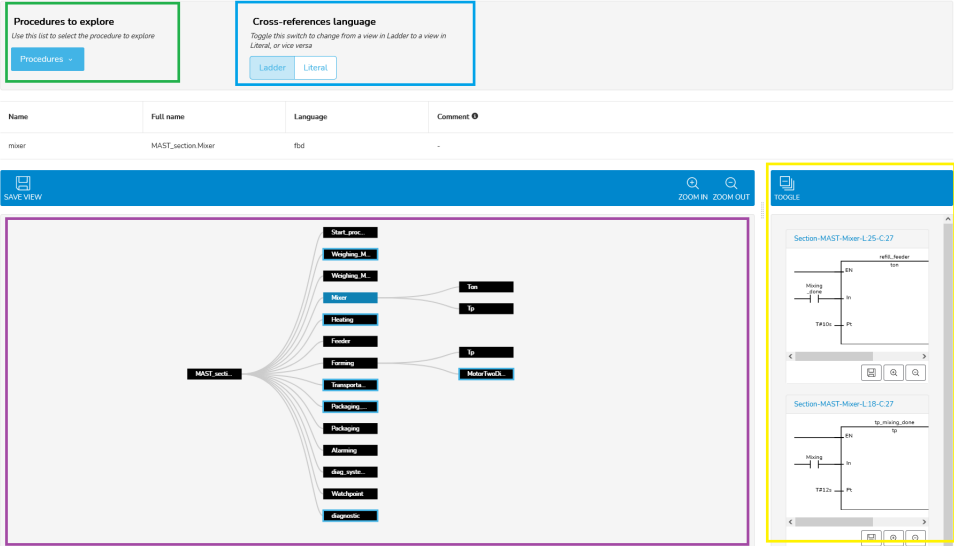

- List of procedures to explore (top left, green frame)
- Dependency tree (bottom left, purple frame)
- Language settings (top right, blue frame)
- Cross references snippets (bottom right, yellow frame)

List of Procedures

The list of procedures lets you select a procedure whose call tree you want to display. Click **List Of Procedures** to select a function, function block or task (which are generally referred to as called “procedure” in the EcoStruxure Control Engineering tools).

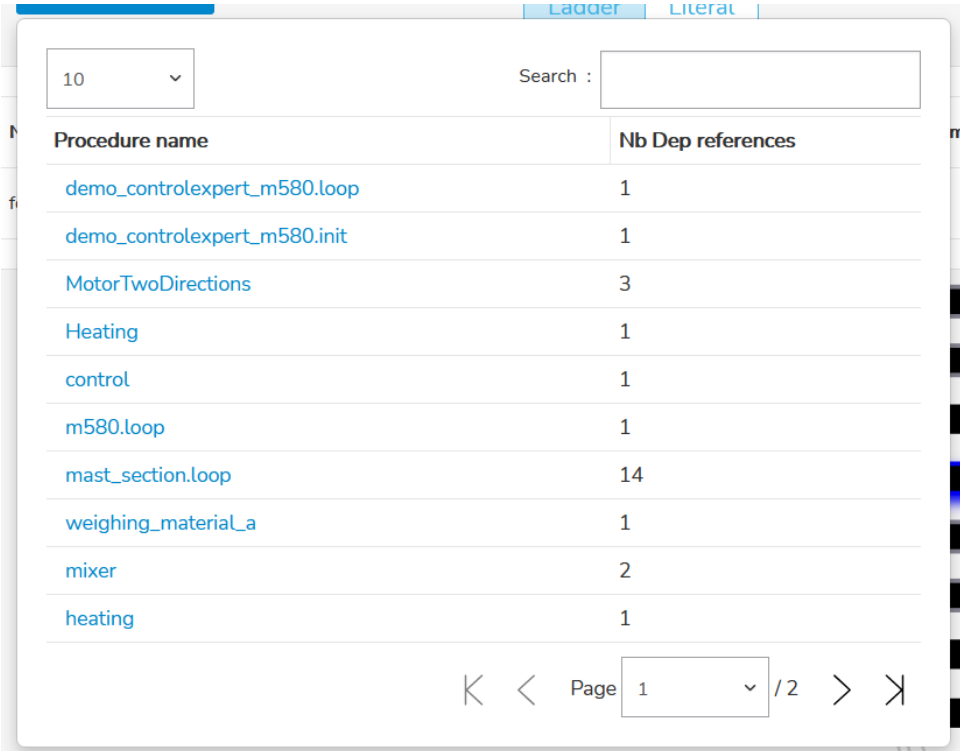

Functions for finding a procedure:

- You can scroll through the list using the page buttons at the bottom of the view. You can specify the number of procedures to be displayed on a single page using the dropdown list at the top left part of the table.
- You can filter the procedures using the search field at the top right part of the list. You can search by full or partial name of the procedure.

Click the name of a procedure to display it in the dependency tree and in the cross references snippets parts of the page.

Dependency Tree

The Dependency tree is a graphical representation of the dependencies between the procedures.

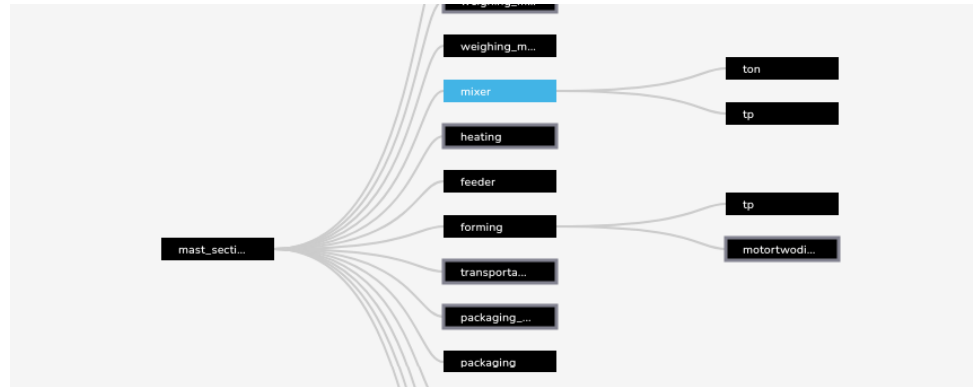

The selected procedure is highlighted in blue. Each linked procedure displayed to its left is a procedure that calls it. Each linked procedure displayed to its right is a procedure that is called by it.

You can explore the relationships between procedures by clicking their names.

This view is helpful to determine how the procedures call each other.

Language Settings

The language settings let you select **Ladder** or **Literal** as the language for the cross reference snippets.

Depending on the different types of procedures, a representation of the code in Ladder may not be available. In such a case, the cross references are displayed in Literal.

Cross References Snippets

The cross references snippets part of the page displays how the different procedures call each other.

It consists of a code extract, displayed in Ladder or Literal language, that highlights the relations. The code extract is not displayed in the same way it is written in the original code in order to provide a synthetic view. Its logic still remains the same as in the original code. The logic can be retrieved using the location displayed behind each snippet.

For instance, if you call a procedure inside several nested conditional instructions, the snippet compresses these instructions into a single one.

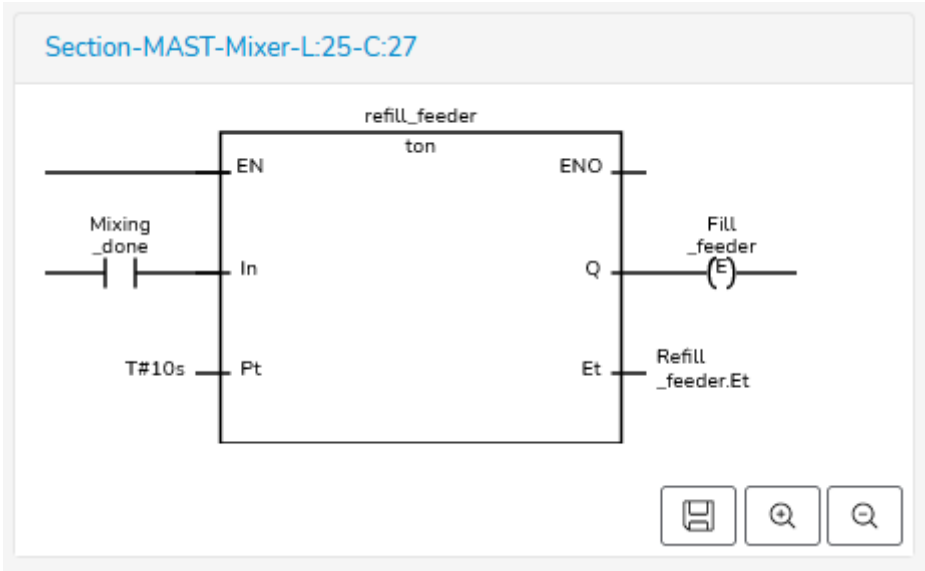

The cross references snippets view is updated each time you select a procedure either in the list of procedures or in the dependency tree.

Downloading an Offline Version of the Documentation

You can download a copy of the EcoStruxure Control Engineering - Documentation online results from the server to your local PC.

Download procedure:

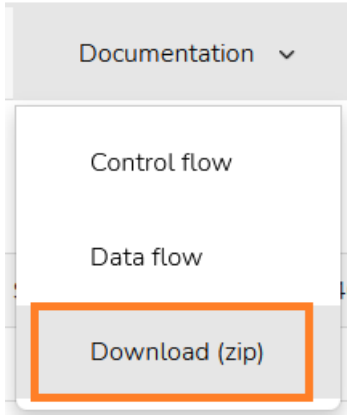
Step	Action
1	Navigate to the Program page.
2	<p>Select Documentation > Download (zip).</p>  <p>A ZIP file with the documentation in HTML format is downloaded to your PC.</p>
3	<p>Extract the contents of the downloaded ZIP file and open the file index.html if you want to work with the downloaded documentation.</p> <p>NOTE: Security policies in your organization may keep your browser from displaying certain or all HTML content stored on your PC. In such cases, contact your administrator to resolve this condition.</p>

Limitations of the Free Trial Version

If the documentation has been created with a free trial license of EcoStruxure Control Engineering - Documentation, the results are limited as shown in the following list.

Functionality	Trial version	Paid license
Control Flow		
List of procedures	Included	Included
Number of dependencies per procedure	Limited to 3	No license limitations
Number of cross-references per procedure	Limited to 2	No license limitations
Data Flow		
List of variables	Included	Included
Number of dependencies/influences per variable	Limited to 3	No license limitations
Number of cross references per variable	Limited to 2	No license limitations
Flow direction	Unidirectional	Unidirectional and bidirectional
Communications		
Number of communications	Limited to 2	No license limitations
Other features		
Save tree view	Unavailable	Included
Download offline version	Unavailable	Included

NOTE: Free license does not allow to download the cross-references.

The functions that are not available or limited are highlighted on the **Documentation** tab of your program:

- Trial: Limited results
- Unavailable: Function is not accessible
- No indication: No license limitations

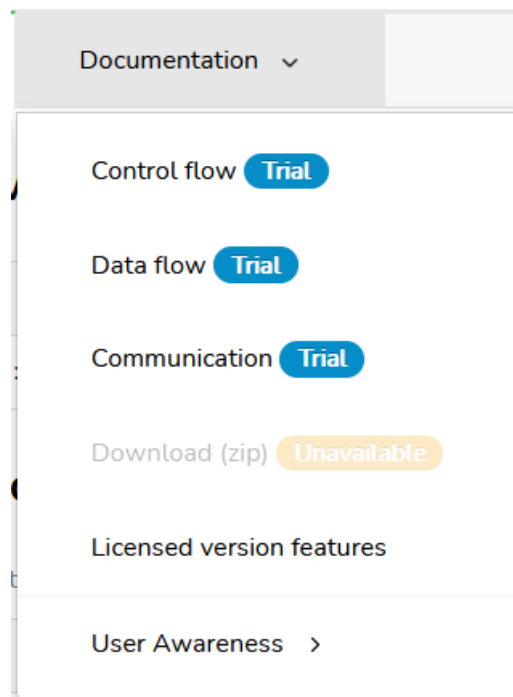

You can upgrade to a paid license to get the full functionality of your program.

Manufacturer-Specific File Export Procedures

EcoStruxure Control Engineering tools use the source code files of controller applications as input files. These files are exported from the corresponding software development environments. The following sections provide information on generating these export files in various software development environments.

EcoStruxure Control Expert (.XEF / .ZEF File Export)

Export the EcoStruxure Control Expert (formerly Unity Pro) controller application to an XEF or a ZEF export file in order to be processed with EcoStruxure Control Engineering tools.

To export the file, you can use the EcoStruxure Control Engineering Import/Export tool. Select **SUPPORT > DOWNLOADS**.

It is also possible to export the files using the EcoStruxure Control Expert menu:

Step	Action
1	From the menu, select File > Export application...
2	In the Export application... dialog box, provide a name for the XEF or ZEF file.
3	If required, modify the storage location for the XEF or ZEF file.
4	Click Save .

EcoStruxure Machine Expert (.EXPORT File Export)

Export the EcoStruxure Machine Expert controller application to an XML export file (with the extension **.export**) in order to be processed with EcoStruxure Control Engineering tools.

Procedure:

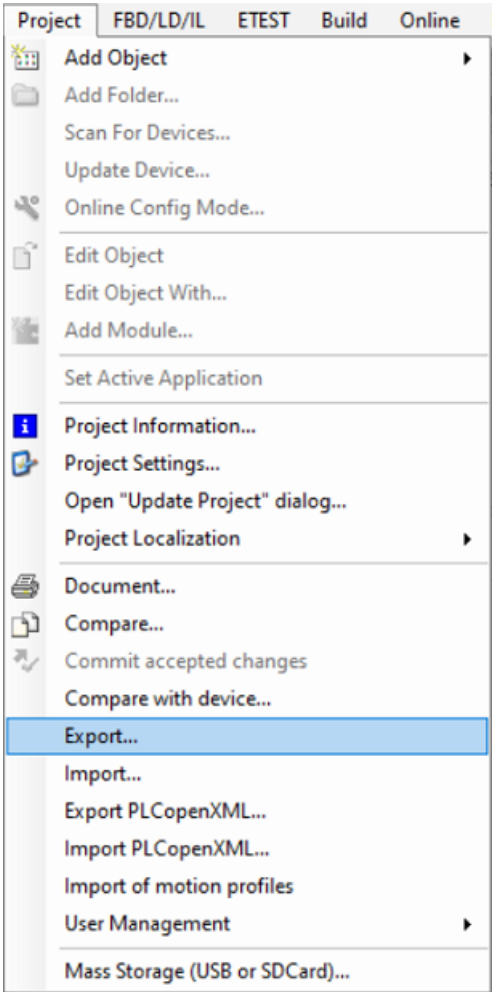
Step	Action
1	<p>From the menu, select Project > Export...</p>  <p>The screenshot shows the 'Project' menu open. The 'Export...' option is highlighted in blue. Other visible options include 'Add Object', 'Add Folder...', 'Scan For Devices...', 'Update Device...', 'Online Config Mode...', 'Edit Object', 'Edit Object With...', 'Add Module...', 'Set Active Application', 'Project Information...', 'Project Settings...', 'Open "Update Project" dialog...', 'Project Localization', 'Document...', 'Compare...', 'Commit accepted changes', 'Compare with device...', 'Import...', 'Export PLCopenXML...', 'Import PLCopenXML...', 'Import of motion profiles', 'User Management', and 'Mass Storage (USB or SDCard)...'.</p>
2	<p>You can export particular objects or a full tree. From the tabs in the Export dialog, select the objects to be included in the export file.</p>

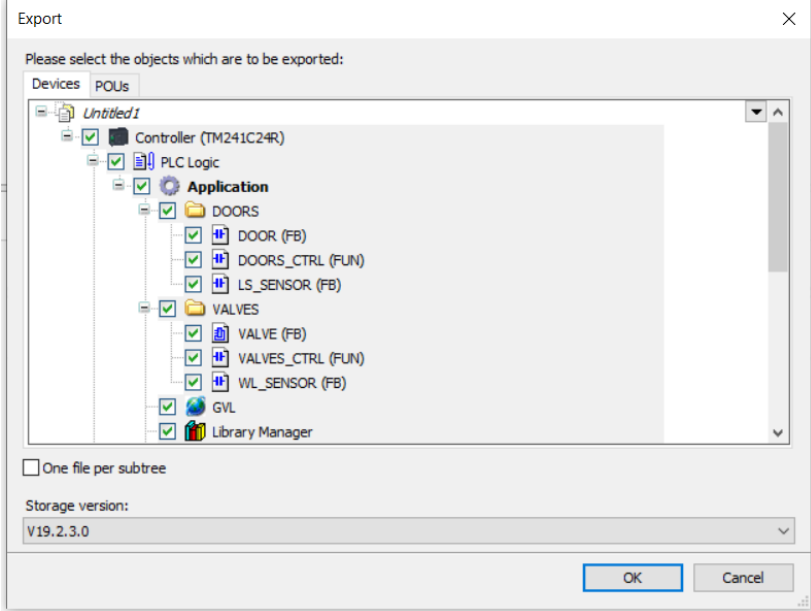
Step	Action
	 <p>NOTE: The checkbox One file per subtree allows you to generate separate export files for the selected subtrees. You can export the file with a specific EcoStruxure Machine Expert version that you select from the dropdown list Storage version. To re-import the file, this EcoStruxure Machine Expert version is used.</p>
3	Click OK and provide a file name and a folder name as prompted.
4	Click Save .

PL7 Pro (.FEF File Export)

Export the PL7 Pro controller application to an FEF export file in order to be processed with EcoStruxure Control Engineering tools.

Prerequisites:

Step	Action
1	Open the PL7 Pro configuration file PI7sys.ini using a text editor. The file is located in the Windows folder (for example, C:\Windows or C:\Winnt).
2	Search for the section [PL7TOOL132] .
3	Verify that the entry ExportPI7Converter=True exists. If the entry does not exist, add the entry in the section [PL7TOOL132] .
4	Save the file. The modification is taken into account with the next start of PL7 Pro. NOTE: This feature is only available with version 4.5 or greater of PL7 Pro.

Procedure:

Step	Action
1	From the menu, select File > Export application...
2	In the Export application... dialog box, provide a name for the FEF file.
3	If required, modify the storage location for the FEF file.
4	Click Save .

3S CODESYS V3 (.EXPORT File Export)

Export the CODESYS V3 controller application to an XML export file (with the extension **.export**) in order to be processed with EcoStruxure Control Engineering tools.

Procedure:

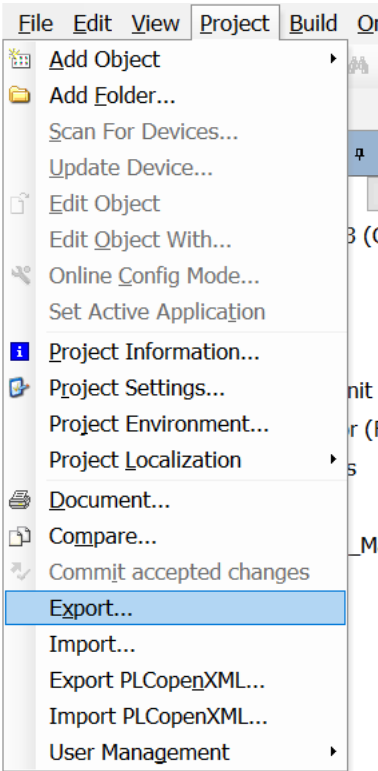
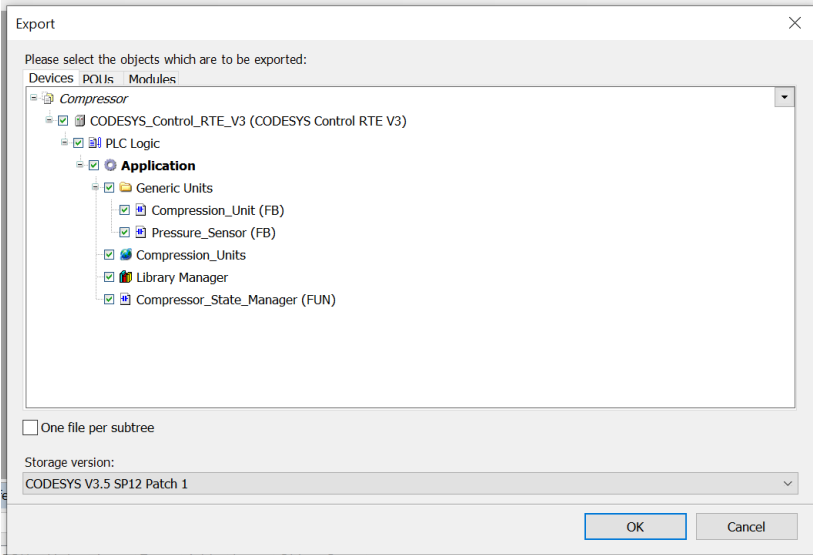
Step	Action
1	<p>From the menu, select Project > Export....</p>  <p>The screenshot shows the 'Project' menu open. The 'Export...' option is highlighted in blue. Other visible options include 'Add Object', 'Add Folder...', 'Scan For Devices...', 'Update Device...', 'Edit Object', 'Edit Object With...', 'Online Config Mode...', 'Set Active Application', 'Project Information...', 'Project Settings...', 'Project Environment...', 'Project Localization', 'Document...', 'Compare...', 'Commit accepted changes', 'Import...', 'Export PLCopenXML...', 'Import PLCopenXML...', and 'User Management'.</p>
2	<p>You can export particular objects or a full tree. From the tabs in the Export dialog, select the objects to be included in the export file.</p>  <p>The screenshot shows the 'Export' dialog box. It has a tree view under the 'Modules' tab. The tree is expanded to show the 'Application' folder, which contains 'Generic Units', 'Compression_Unit (FB)', 'Pressure_Sensor (FB)', 'Compression_Units', 'Library Manager', and 'Compressor_State_Manager (FUN)'. All these items are checked. Below the tree, there is an unchecked checkbox for 'One file per subtree' and a 'Storage version' dropdown menu set to 'CODESYS V3.5 SP12 Patch 1'. 'OK' and 'Cancel' buttons are at the bottom right.</p> <p>NOTE: The checkbox One file per subtree allows you to generate separate export files for the selected subtrees. You can export the file with a specific CODESYS version that you select from the dropdown list Storage version. This version is then used to re-import the file in CODESYS. If you work on CODESYS V3 code, select a version from the version 3 family (CODESYS V3 ...).</p>

Step	Action
3	Click OK .
4	Provide a file name and a folder name as prompted and click Save .

3S CODESYS V2 (.EXP File Export)

Export the CODESYS V2 controller application to an EXP export file in order to be processed with EcoStruxure Control Engineering tools.

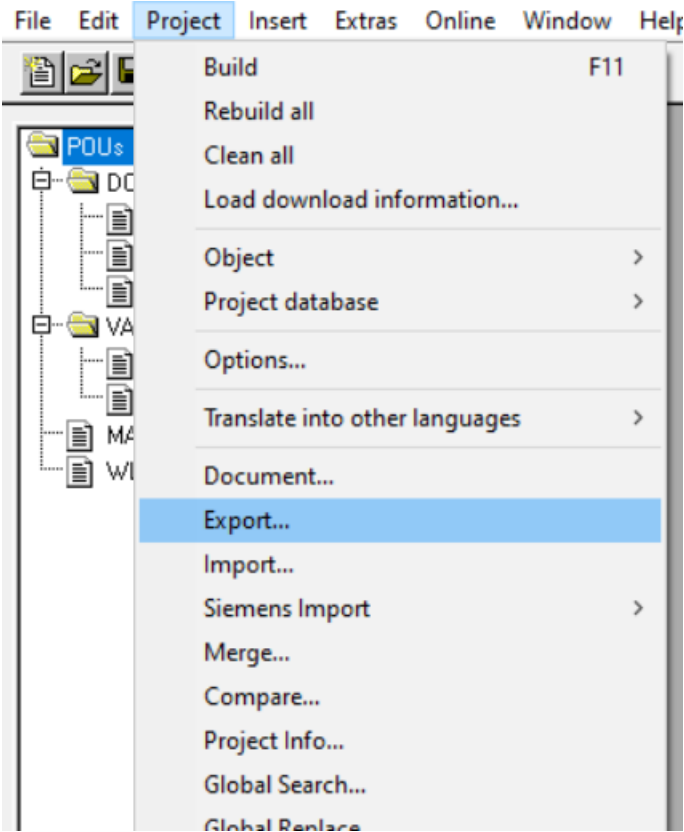
Step	Action
1	<p>From the menu, select Project > Export...</p>  <p>The screenshot shows the 'Project' menu open in the CODESYS V2 software. The menu items are: Build (F11), Rebuild all, Clean all, Load download information..., Object >, Project database >, Options..., Translate into other languages >, Document..., Export... (highlighted in blue), Import..., Siemens Import >, Merge..., Compare..., Project Info..., Global Search..., and Global Replace.</p>
2	<p>In the Export Project dialog box, select the objects to be included in the export file (with the default settings, a selected item has a blue background), then click OK.</p>

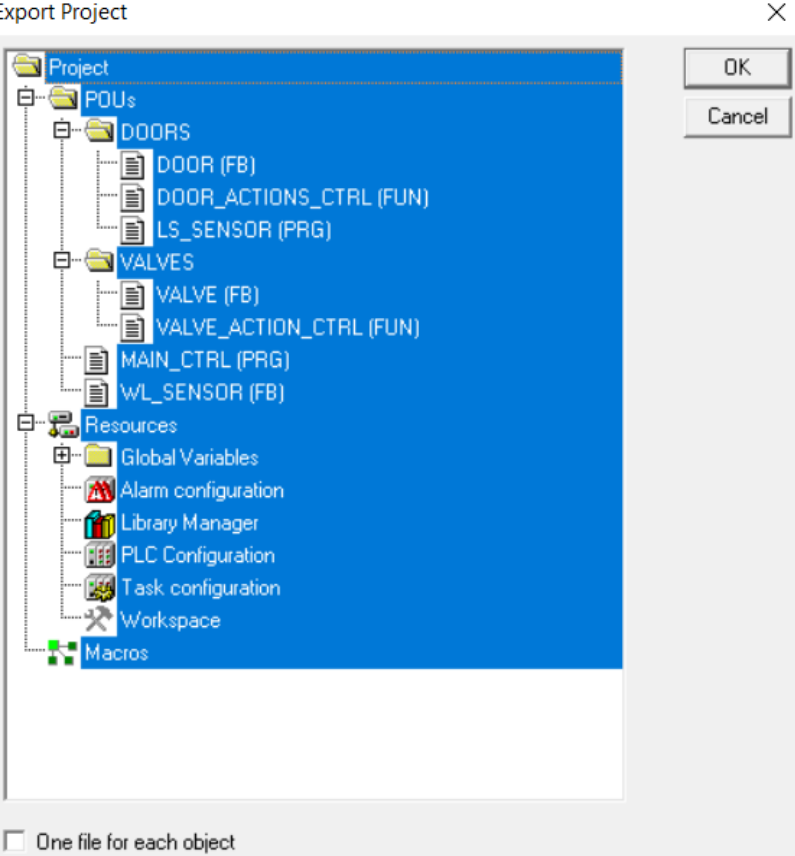
Step	Action
	 <p>Export Project</p> <p><input type="checkbox"/> One file for each object</p>
3	Click OK and provide a file name and a folder name as prompted.
4	Click Save .

BECKHOFF TwinCAT V3 (.XML File Export)

Export the Beckhoff TwinCAT controller application to an XML export file (PLCopen) in order to be processed with EcoStruxure Control Engineering tools.

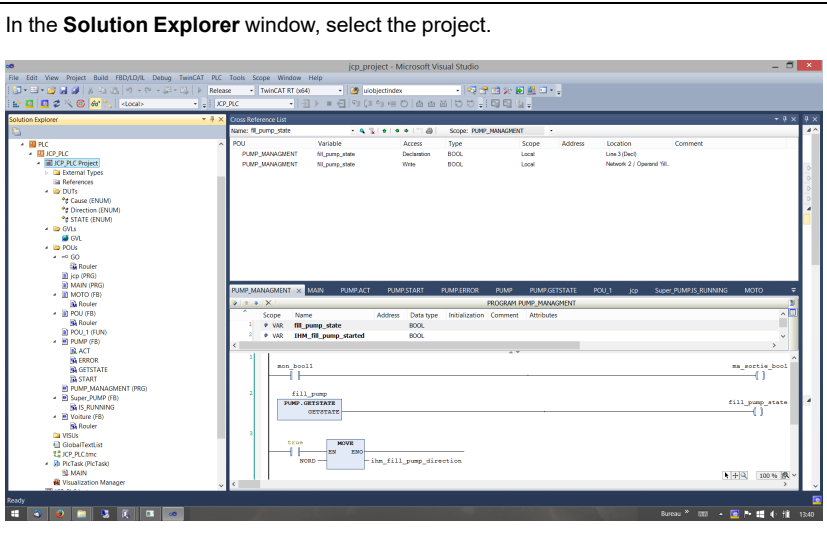
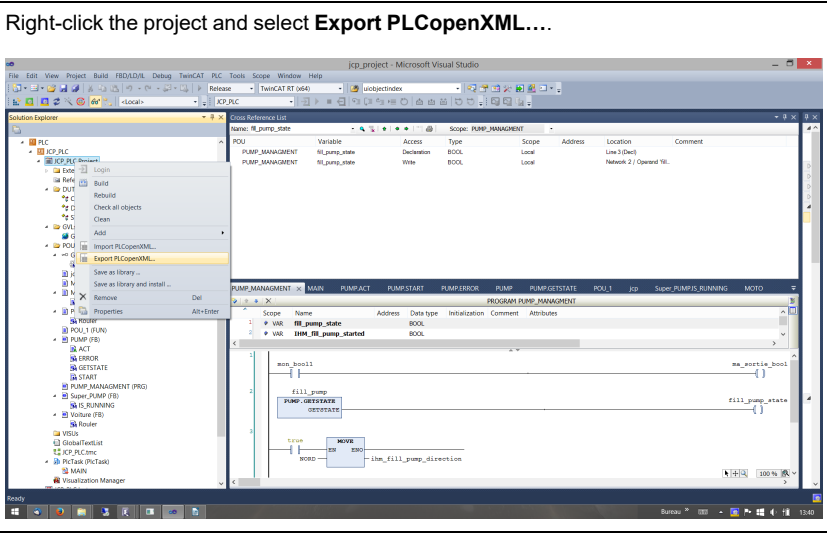
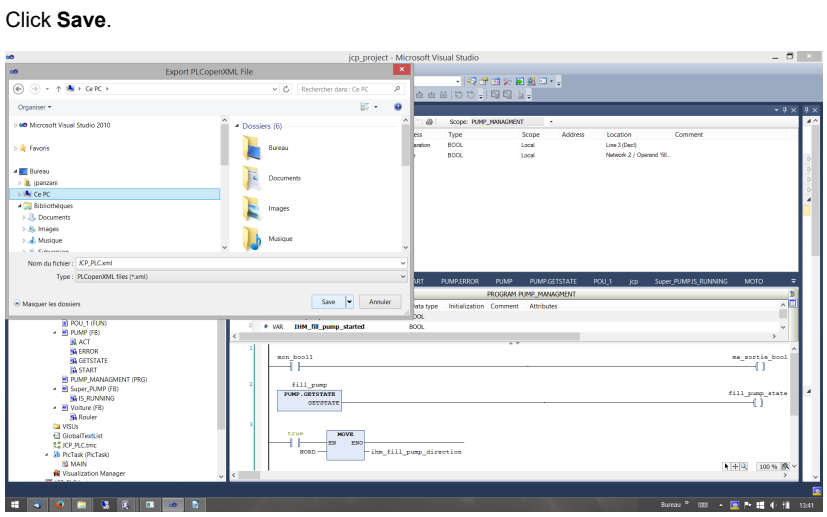
Step	Action
1	<p>In the Solution Explorer window, select the project.</p> 
2	<p>Right-click the project and select Export PLCopenXML...</p> 
3	<p>Click Save.</p> 

PHOENIX CONTACT Multiprog v5.5 (.XML File Export)

Export the MULTIPROG controller application to an XML export file in order to be processed with EcoStruxure Control Engineering tools.

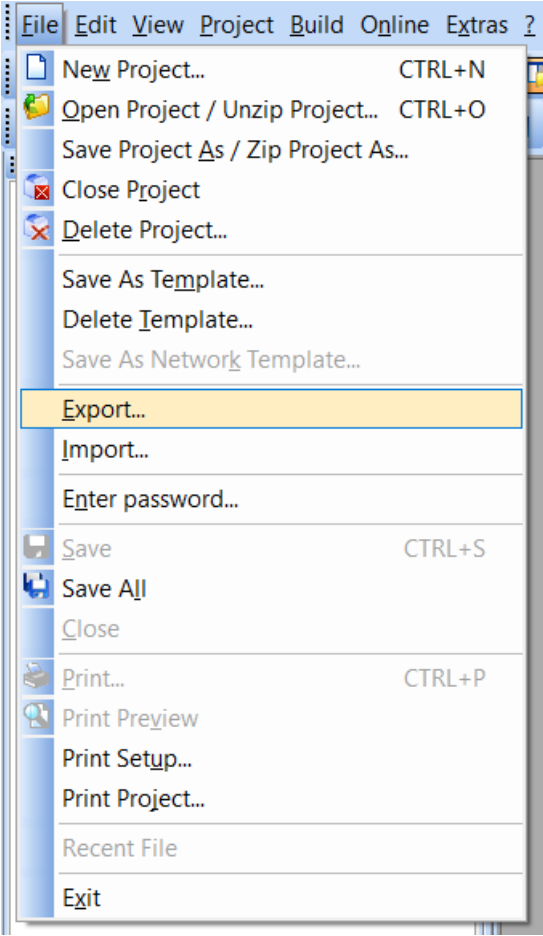
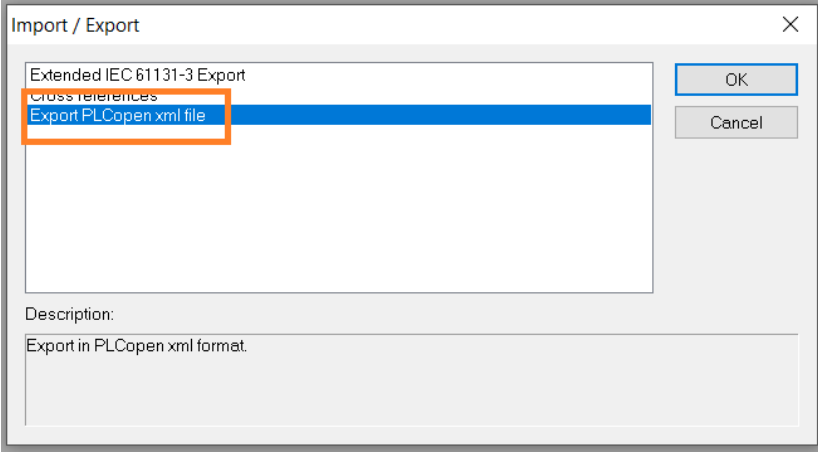
Step	Action
1	<p>From the menu, select File > Export...</p> 
2	<p>Select Export PLCopen xml file.</p> 
3	<p>Provide a name for the export file.</p>
4	<p>Click Save.</p>

As MULTIPROG can export the controller application in different versions of PLCopen, there may be differences in the way your EcoStruxure Control Engineering tool processes the export file, depending on the PLCopen version.

Rockwell Automation® RSLogix 5000® or Studio 5000 (.L5K File Export)

Export the Rockwell Automation® RSLogix 5000® controller application to a L5K export file in order to be processed with EcoStruxure Control Engineering tools.

Step	Action
1	From the menu, select File > Save as....
2	In the Save as... dialog box, provide a name for the L5K file.
3	If required, modify the storage location.
4	Select the file type: RSLogix 5000 Import/Export File (*.L5K) .
5	Click Save .

Siemens SIMATIC STEP 7 (.ASC, .AWL, .GR7 and .SCL File Export)

Overview

The following steps are required to process a Siemens SIMATIC STEP 7 controller application with EcoStruxure Control Engineering tools:

- Set your SIMATIC STEP 7 workshop to German abbreviations (mnemonics).
- Create and export the symbols of the controller application to an **.ASC** file.
- Create and export the contact code (CONT) to an **.AWL** file.
- Create and export the graph blocks (GRAPH) to **.GR7** files.
- Compile the CFC code (if any) to create the corresponding **SCL** sources.
- Export structural codes (SCL) to **.SCL** files.

Setting German Mnemonics

Before creating the export files, set your SIMATIC STEP 7 workshop to German abbreviations (mnemonics):

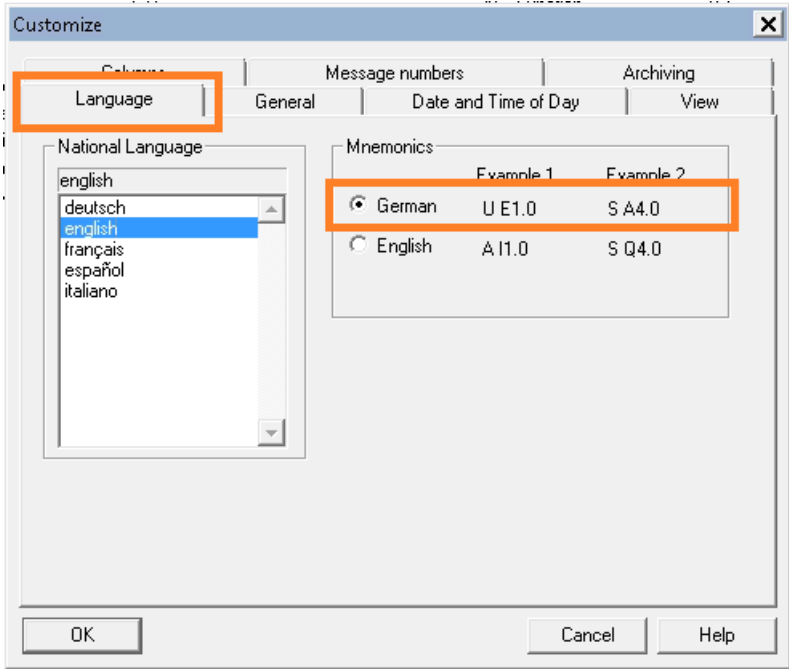
Step	Action
1	From the menu, select Options > Customize....
2	Display the Language tab. 
3	Select German mnemonics.
4	Click OK .

Creating an ASC File

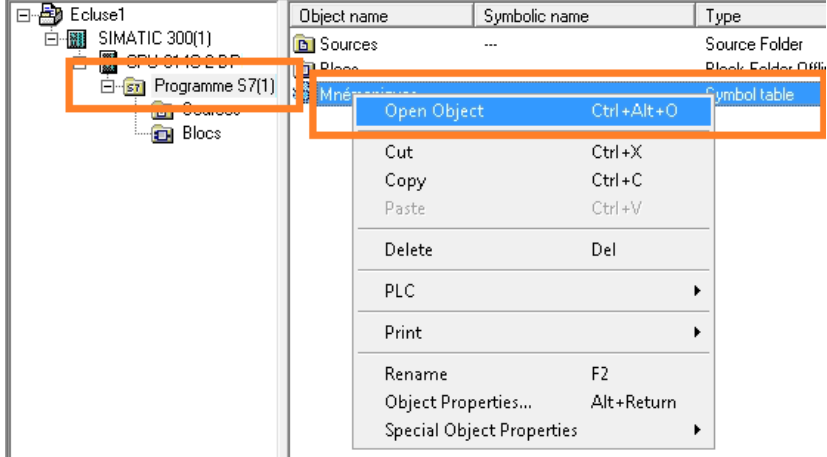
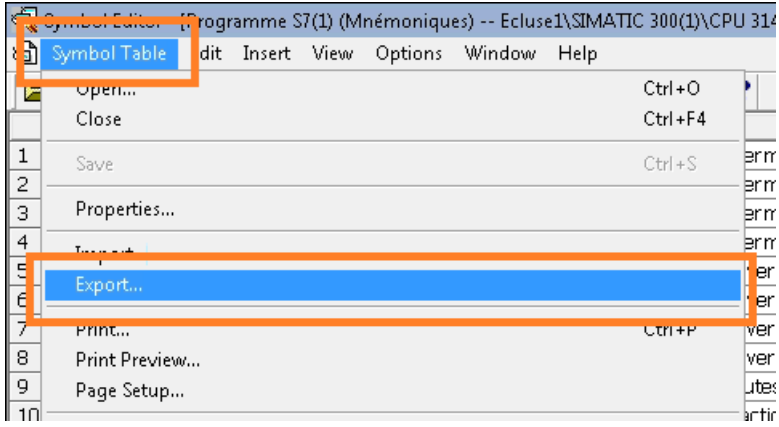
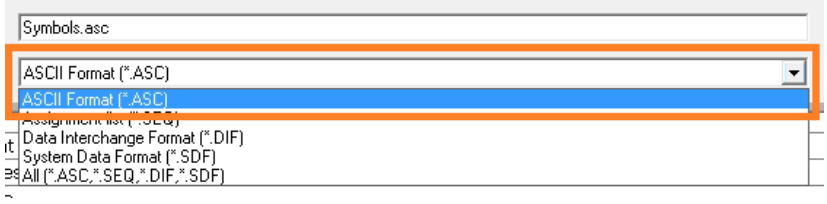
Step	Action
1	<p>Right-click the symbols table in your program folder and select Open object.</p> 
2	<p>From the menu of the symbols editor, select Symbol Table > Export...</p> 
3	<p>Select ASCII Format (*.ASC).</p> 
4	Provide a name and select a directory for the .ASC export file.
5	Click Save .

Creating an AWL File

To create an **.AWL** file, first generate the LIST source for the code blocks developed in the languages CONT, LIST and LOG.

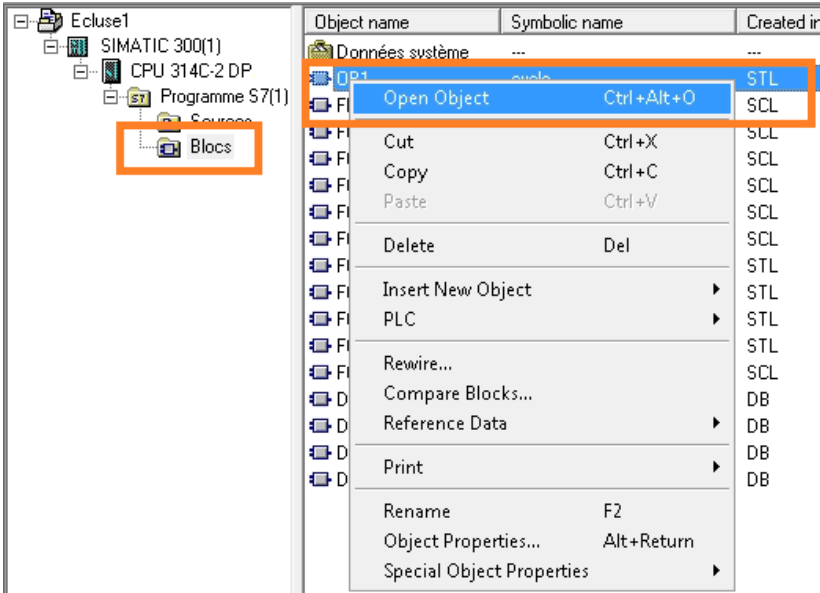
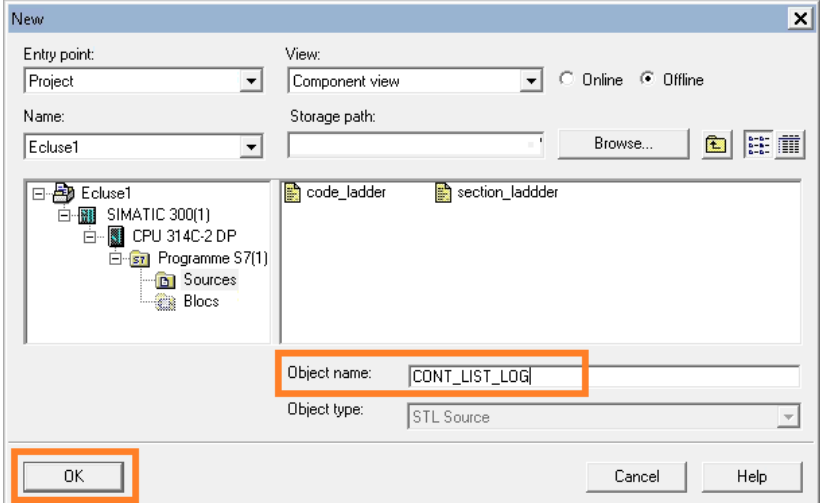
Step	Action
1	<p>Right-click a CONT, LIST or LOG source and select Open Object to open the CONT/ LIST/LOG code editor.</p> 
2	From the menu, select File > Close to close all open objects.
3	From the menu, select File > Generate source... to generate the program source.
4	<p>Provide an object name and click OK.</p> 

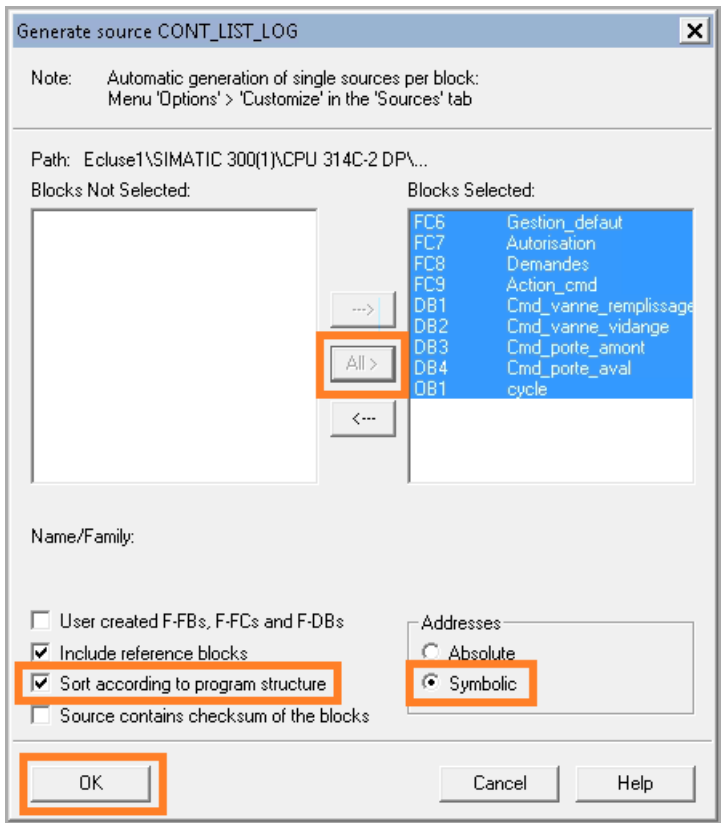
Step	Action
5	<p>Click All to select all program blocks and select the options Sort according to program structure and Symbolic addresses.</p> 
6	Click OK to confirm.

If your controller application contains safety-related blocks, export those blocks in a separate **AWL** file. Refer to *Safety-Related Applications*, page 61 for details.

Creating GR7 Files

The **.GR7** sources have to be created for each GRAPH blocks separately. Repeat the following procedure for each GRAPH block to be exported.

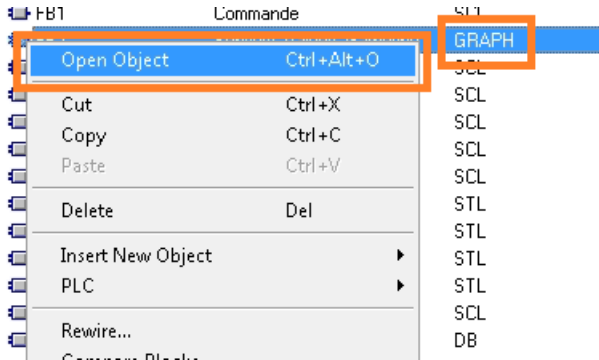
Step	Action
1	<p>Right-click a GRAPH object and select Open Object.</p> 
2	From the menu, select File > Generate Source File .

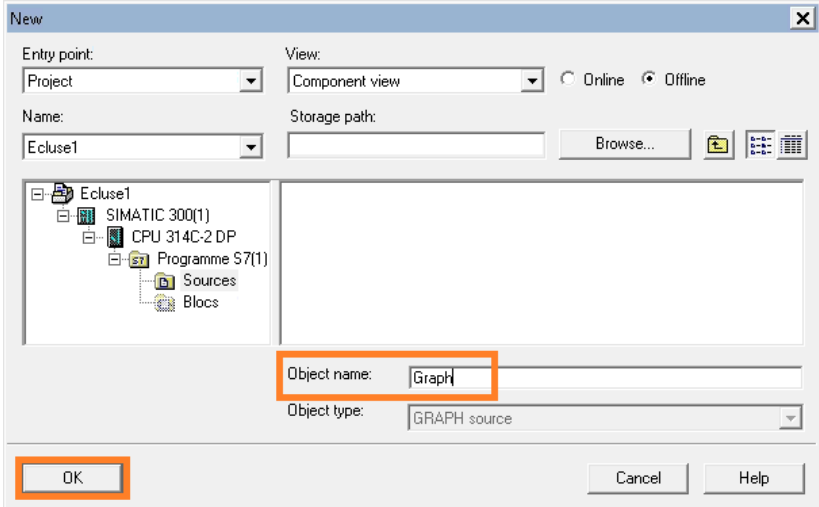
Step	Action
3	Provide a name for the GRAPH object. 
4	Click OK to confirm.
5	Repeat the procedure for each GRAPH object to be exported.

Creating a CFG File

The CFG file is required for analyzing the communication and the hardware configuration of the station.

Step	Action
1	Double-click your controller links in the main window to open NetPro.
2	In the NetPro window, double-click the controller of the station to be exported open the HW Config utility.
3	From the Station menu, select Export... to export your station configuration (leave the default settings in the dialog box).

Creating a SCL File for CFC Codes

If the controller application contains CFC code, compile the code to generate the corresponding SCL source file which is the file to be processed with EcoStruxure Control Engineering tools.

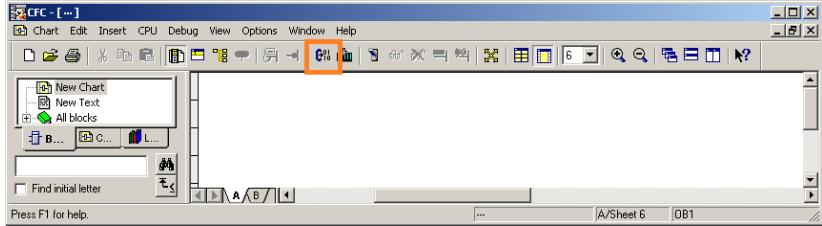
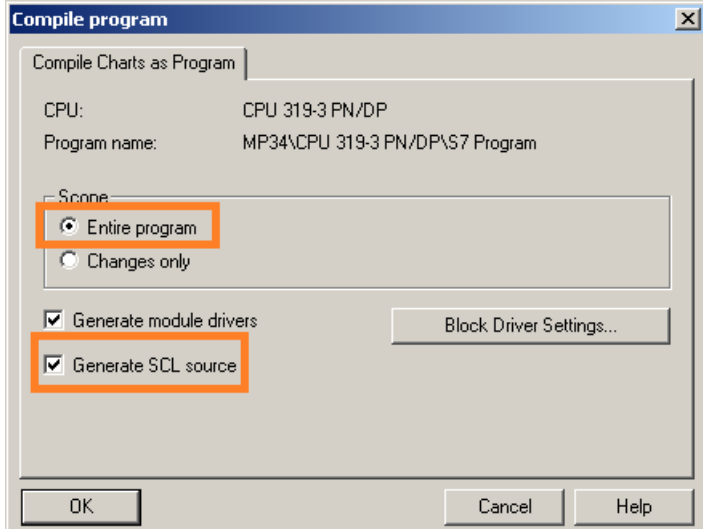
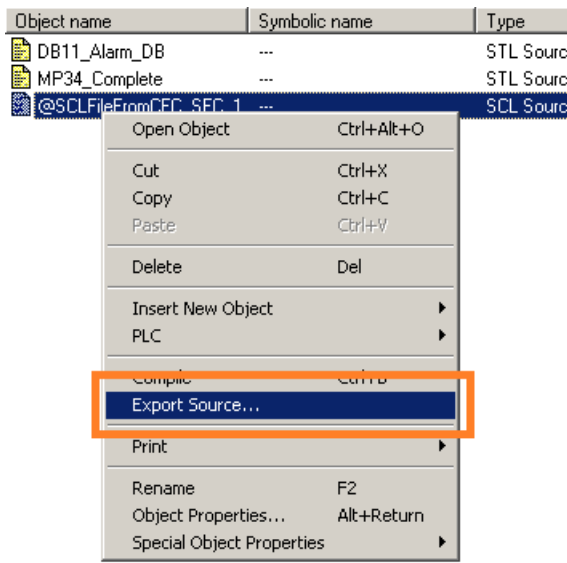
Step	Action
1	<p>Open the CFC code editor by clicking its icon in the toolbar of the main window.</p> 
2	<p>Compile the code with the options Entire program and Generate SCL sources and click OK.</p> 
3	<p>The generated SCL source file can then be exported like other source files (refer to Exporting Files, page 64).</p> 

Safety-Related Applications

A safety-related controller application contains two code parts:

- The non-safety-related code part
- The safety-related code part

Procedure for exporting controller applications that contain safety-related code:

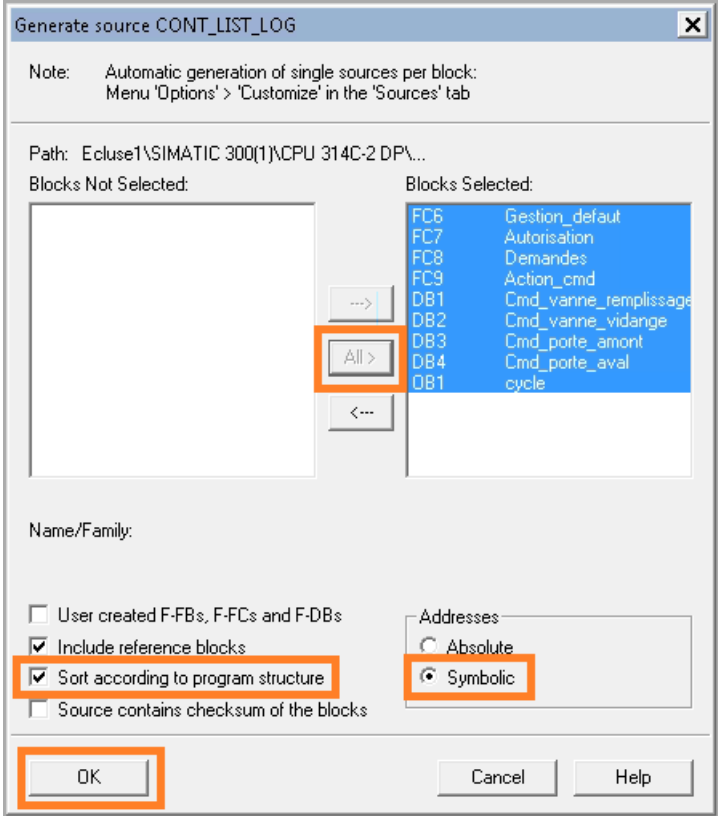
Step	Action
1	Export the .ASC file that contains the database for the safety-related code and for the non-safety-related code (refer to <i>Creating an ASC File</i> , page 57).
2	Generate the sources for the non-safety-related code parts (refer to <i>Creating an AWL File</i> , page 57 and <i>Creating a GR7 File</i> , page 59).
3	<p>Click All to select all program blocks and select the options Sort according to program structure and Symbolic addresses.</p> 
4	Click OK to confirm.
5	Follow the procedure for <i>Creating an AWL File</i> , page 57 until the dialog box Generate source Safety is displayed.

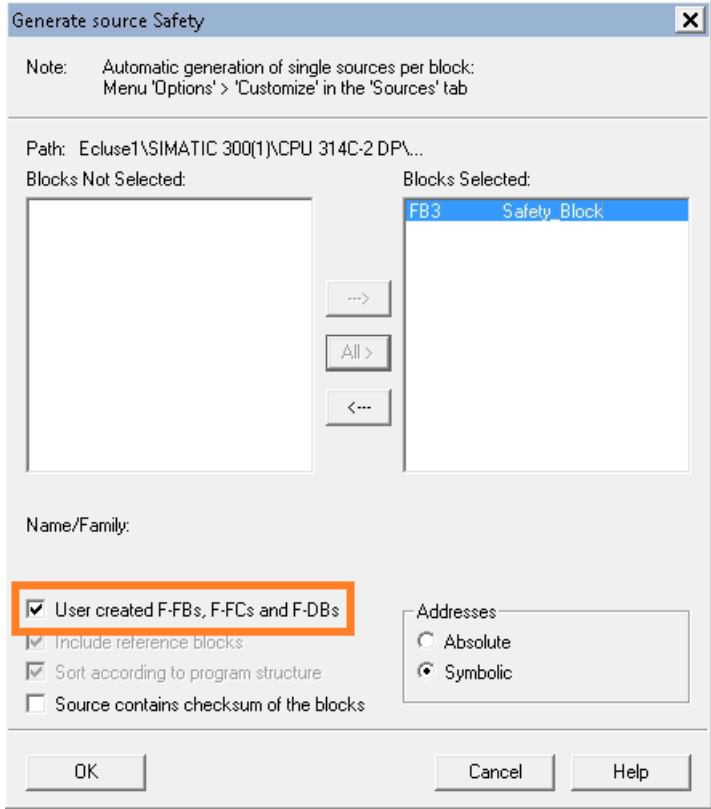
Step	Action
6	<p>Select the option User-created F-FBs, F-FCs and F-DBs and click OK to confirm.</p> 
7	<p>Create a .dif file (refer to Creating a dif File, page 63). The .dif file is used to determine whether code is safety-related.</p>

Creating a dif File

A **.dif** file is created in the SIMATIC Manager of SIMATIC STEP 7 in the following way:

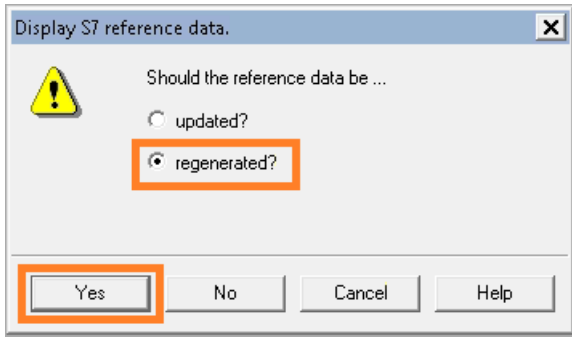
Step	Action
1	From the menu, select Options > Reference Data > Display .
2	<p>In the Display S7 reference data dialog box, select the option regenerated? and click Yes.</p> 

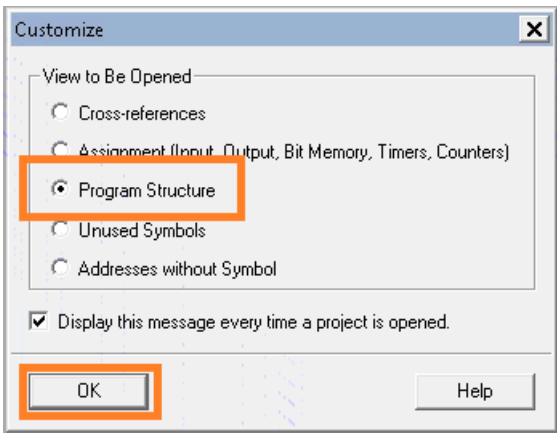
Step	Action
3	In the Customize dialog box, select the option Program Structure and click OK to display the program structure. 
4	From the menu, select View > Export to open the Save dialog box.
5	Provide a name for the .dif and click Save .

Exporting Files

After you have created the files, export them from SIMATIC STEP 7:

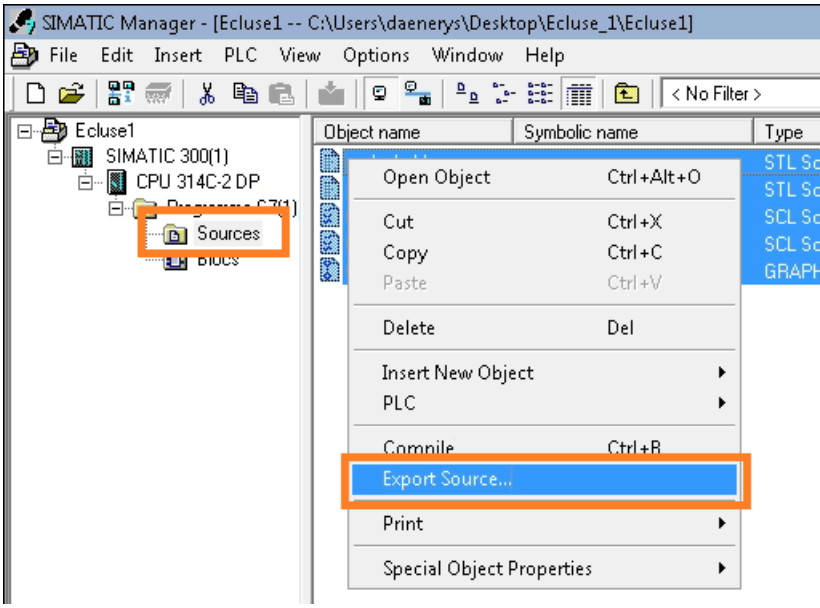
Step	Action
1	Select the LIST, GRAPH (or .AWL and .GR7 files) and SCL sources that you have generated.
2	Right-click the sources and select Export source.... 
3	Select a file name and a storage location and click Save .

Siemens TIA Portal SIMATIC STEP 7 (.ZIP File Export)

Export the Siemens TIA Portal SIMATIC STEP 7 controller application to a ZIP export file in order to be processed with EcoStruxure Control Engineering tools.

The export can be performed automatically with the EcoStruxure Control Engineering - Import/Export tool. Select **SUPPORT > DOWNLOADS**.

Refer to the EcoStruxure Control Engineering - Import/Export user guide for details on the export procedure.

Schneider Electric
35 rue Joseph Monier
92500 Rueil Malmaison
France

+ 33 (0) 1 41 29 70 00

www.se.com

As standards, specifications, and design change from time to time,
please ask for confirmation of the information given in this publication.

© 2023 Schneider Electric. All rights reserved.

EIO0000004426.06