



Modicon M340 automation platform

Mid-range PLC/PAC for industrial
process and infrastructure control



Modicon

Discover Modicon

Industrial Edge control for IIoT

Modicon IIoT-native edge controllers manage complex interfaces across assets and devices or directly into the cloud, with embedded safety and cybersecurity. Modicon provides performance and scalability for a wide range of industrial applications up to high-performance multi-axis machines and high-available redundant processes.

Explore our offer

- Modicon HVAC Controllers
- Modicon PLC
- Modicon Motion Controllers
- Modicon PAC
- Modicon I/O
- Modicon Networking
- Modicon Power Supply
- Modicon Wiring

Life Is On



Quick access to product information

Get technical information about your product

References

Modicon TM3
I/O expansion modules for Modicon controllers
Analog I/O modules

Number and type of channels	Input range	Output range	Resolution	Input format (mA/V)	Reference	Weight (kg)
2 voltage inputs	-15...+15 VDC 0...20 mA r.t. 20 mA	16.00V or 12.00V r.t.	16.00V or 12.00V r.t.	0VDC 0VDC	TM3AI2H TM3AI2G	0.110 0.100
4 voltage inputs	-15...+15 VDC 0...20 mA r.t. 20 mA	16.00V or 12.00V r.t.	16.00V or 12.00V r.t.	0VDC 0VDC	TM3AI4H TM3AI4G	0.110 0.100
4 differential or temperature inputs	-15...+15 VDC 0...20 mA r.t. 20 mA RTD (PT100, NI1000, NI750, PT200) -15...+15 VDC 0...20 mA r.t.	16.00V or 12.00V r.t.	16.00V or 12.00V r.t.	0VDC 0VDC	TM3DI4H TM3DI4G	0.110 0.100
4 differential temperature inputs	-15...+15 VDC 0...20 mA r.t.	16.00V or 12.00V r.t.	16.00V or 12.00V r.t.	0VDC 0VDC	TM3TI4H TM3TI4G	0.110 0.100
8 self-diagnosing	-15...+15 VDC	12.00V r.t.	12.00V r.t.	0VDC	TM3I8H	0.110

Share Price Global (English)

Life Is On Schneider Electric

Search products, documents & more

My Products My Documents Partner Portal

PRODUCTS SOLUTIONS SERVICES SUPPORT ABOUT US

All products Industrial Automation and Control PLC, PAC and Dedicated Controllers Distributed Input/Output (I/O) Modules Modicon TMI

View all Modicon TMI

TM3AI2H

Module TM3 - 2 analog inputs high resolution

Show more characteristics >

Related Software >

Add to My Products

Compare

Product Datasheet User guide Catalogue CAD Document

Characteristics Documents and Downloads Technical FAQs Additional Information Dimensions Drawings >

Main

range of product Modicon TMI

product or component type Analog input module

range compatibility Modicon M251

Modicon A85A

Each commercial reference presented in a catalog contains a hyperlink. Click on it to obtain the technical information of the product:

- Characteristics, Dimensions and drawings, Mounting and clearance, Connections and schemas, Performance curves
- Product image, Instruction sheet, User guide, Product certifications, End of life manual

Find your catalog

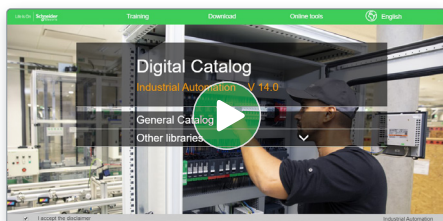

- > With just 3 clicks, you can access the Industrial Automation and Control catalogs, in both English and French
- > Consult digital automation catalogs at [Digi-Cat Online](#)

Industrial Automation

General Catalog

Publications, Datasheets, PLC Ladder & Symbols

- Books, Catalogs & Interfaces
- Signaling Devices
- HMI (Terminals and Industrial PC)
- Sensors & RFID System
- Motor Starters and Load Management
- Components for Motor Starters
- Variable Speed Drives & Soft Starters
- Motor Control & Robotics
- Interface, Measurement & Control Relays
- PLC, PAC & other Controllers

Publications, Datasheets, PLC Ladder & Symbols

- 20 PLC Ladder and symbols publications
- 20 PLC Ladder and symbols publications
- 20 PLC Ladder and symbols publications
- 20 PLC Ladder and symbols publications
- 20 PLC Ladder and symbols publications
- 20 PLC Ladder and symbols publications
- 20 PLC Ladder and symbols publications
- 20 PLC Ladder and symbols publications
- 20 PLC Ladder and symbols publications
- 20 PLC Ladder and symbols publications

Homeless 200

Product Selector

Online 360°

- Up-to-date catalogs
- Embedded product selectors, 360° pictures
- Optimized search by commercial references

Select your training



- > Find the right [Training](#) for your needs on our Global website
- > Locate the training center with the selector tool, using this [link](#)

Training and courses

Training by domain of expertise

- Electrical Installation and Safety
- Data Center
- Industrial Automation

General contents

Presentation	1
Processors	2
Communication	3
Architectures	4
Dedicated parts for severe environments	5
Standards and certifications	6
Services, index	7

Schneider Electric's IoT-enabled, plug-and-play, open, secure, interoperable architecture and platform, in Industries, Infrastructures, Data Centers, and Buildings.

Innovation at every level

EcoStruxure is based on a three-tiered technology stack delivering innovation at every level, from connected products to edge control and apps, analytics, and services.

Together with our hybrid segments approach, this enhances your value around safety, reliability, operational efficiency, sustainability, and connectivity across 6 domains of expertise:

- Power
- IT
- Building
- Machine
- Plant
- Grid

Dedicated architectures and IoT

We tailor our solutions in the form of dedicated reference architectures for plants:

- Management systems
- Power systems
- Data center systems
- Industrial plant and machine systems
- Smart grid systems

The Industrial Internet of Things (IIoT) gives an additional boost to technologies. That's why we provide our customers with an IoT-enabled architecture and platform offering simple, reliable, productive, and cost-efficient solutions.

Cybersecurity solutions

Robust cybersecurity protection is a must, and Schneider Electric's solutions can deliver it, regardless of business type or industry.

The vendor-agnostic services provided by our skilled professionals help to protect your entire critical infrastructure. We help to assess your risk, implement cyber-specific solutions, and maintain your onsite defenses over time, while integrating appropriate IT policies and requirements.

This is our difference and your advantage.

Enhanced safety

With the release of M580 Safety, Schneider Electric further expands the EcoStruxure platform.

This consolidates our position as one of the most trusted industrial safety vendor, with thousands of Modicon and Triconex safety systems protecting the most critical industrial processes globally.

EcoStruxure™ for Plant
Innovation At Every Level



*The Schneider Electric industrial software business and AVEVA have merged to trade as AVEVA Group plc, a UK listed company. The Schneider Electric and Life is On trademarks are owned by Schneider Electric and are being licensed to AVEVA by Schneider Electric.

- **Overview**
 - Compact..... *page 1/2*
 - Flexible..... *page 1/2*
 - Scalable..... *page 1/2*
 - Robust..... *page 1/3*
 - Sustainable..... *page 1/3*
- **Platform composition**
 - Presentation, processors..... *page 1/4*
 - X80 module platform, additional modules *page 1/4*
 - Treatment for severe environments *page 1/4*
 - Design and setup of Modicon M340 applications *page 1/5*
 - Composition of a multi-rack configuration *page 1/5*
 - Cybersecurity *page 1/5*
- **Product compatibility according to network architecture..... *page 1/6***

Modicon M340 automation platform

Mid-range PLC/PAC

1

Modicon M340 PAC Mid-range PAC

Modicon M340 mid-range PAC (Programmable Automation Controller) offers compactness, flexibility, scalability, and robustness for the process industry and a wide range of demanding automation applications. With other PACs of Modicon range, it shares :

- > EcoStruxure Control Expert as a common engineering software to configure the hardware and create application programs.
- > Same X80 I/O system, racks and power supplies as Modicon M580 PAC
- > Modular Modicon STB distributed I/O on multiple networks and fieldbus



Modicon M340 automation platform



Processor built-in native communication capabilities



SD-card for application recovery or firmware upgrade



Easily design your process or application with scalable topology

Compact

Built-in field bus and/or Ethernet communication design

- > Compact-shaped (100 mm high, 93 mm deep, 32 mm wide), M340 occupies only one slot in the rack
- > Five variants with native integrated communication capabilities: CANopen, Modbus Serial link, Modbus/TCP

Flexible

Suits to all control needs

- > Expand X80 local rack with 4, 6, 8, or 12 slot backplane (up to 4 backplanes supported)
- > Hot swappable I/O modules during operation thanks to M340 rack architecture
- > Recover applications or upgrade firmware via SD card
- > Available in EcoStruxure Process Expert
- > EcoStruxure Plant/Architecture Builder available and free to define the best control architecture

Scalable

Develop your plant confidently

- > Support a wide range of X80 modules
 - > Communication modules
 - > Expert modules
 - > High density discreet I/O modules up to 64 channels
- > Ethernet communication modules: Modbus/TCP, EtherNet/IP, DNP3
- > Field bus communication modules: Modbus Serial, AS-Interface, Profibus DP
- > Distributed STB I/O system on Ethernet or field bus

+ Native communication capabilities



Modicon M340 design complies with automation standards

Robust

Strong experience as a field-proven controller

- > M340 performances exceed certification standards
- > Hardened version for more severe environments, conforming to:
 - > IEC/EN 60721-3-3 class 3C1, 3C2, 3C3, 3C4
 - > ISA S71.04 classes G1, G2, G3, Gx
 - > IEC/EN 60068-2-52 salt mist, Kb test severity level

Characteristics	Modicon M340 automation platform	IEC standards Values required by
Mechanical constraints	Levels reached	IEC 60068-2
Shocks	30 g	> 15g
Vibrations	3 g	> 1 g
Electrical immunity	Levels reached	IEC 61131-2-2
Radiated fields	15 V/m	> 10 V/m
Electrostatic discharges by contact	6 kV	> 4 kV
Environmental immunity	Working values	IEC 61131-2-2
Temperature	0...60 °C/32... 140 °F	> 5...55 °C/41... 131 °F
Modicon M340 offer for severe environments	- 25...70 °C/32... 158 °F	> 5...55 °C/41... 131 °F
Corrosive environments (coated versions)		Class Gx, 3C4, Kb, 3S4, 3B2



Modicon family with common X80 modules

Sustainable

Environmental concerns as a global strategy

- > Green Premium Eco Label
- > Life cycle management support
- > Common Modicon X80 modules reduce training and maintenance costs

For more details about Modicon product full capabilities when combined with Modicon M340 automation platform, see our catalogs:



DIA6ED2151012EN



DIA6ED2131203EN

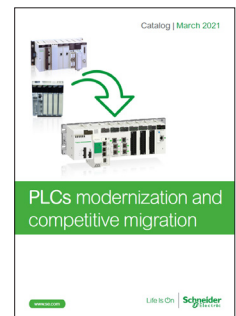

DIA6ED2171102EN

+ Scalable topology easily designed

Modicon M340 automation platform

Composition

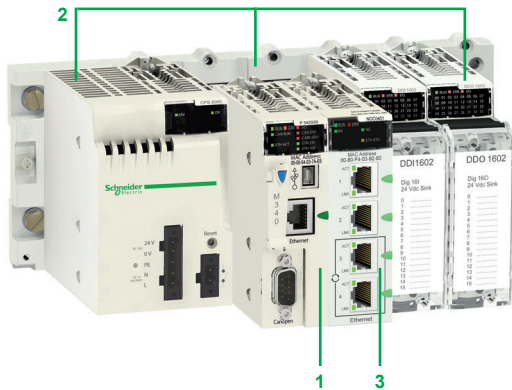

Modicon M340 automation platform comprising:
 - BMXP34 type processors,
 - A single-rack or multi-rack Modicon X80 module platform,
 - Additional dedicated modules.

Presentation

The Modicon M340 automation platform comprises:

- 1 BMXP34 dedicated processors
- 2 A Modicon X80 module platform, in a single-rack or multi-rack configuration
- 3 Additional modules for various applications (application-specific, Ethernet communication, etc.)

Modicon M340 processors

Five processor models comprising one Standard model (**BMXP341000**) and four Performance models (**BMXP3420** or **BMXP3420CL**) with different memory capacities, processing speeds, number of I/O and number and type of communication ports.

Depending on the model, they offer a maximum (non-cumulative) of:

- 512 or 1024 discrete I/O
- 128 or 256 analog I/O
- 20 or 36 application-specific channels (1) (process counter, motion control and serial link, or RTU)
- 0 to 3 Ethernet Modbus/TCP or EtherNet/IP networks (with or without integrated port and 2 network modules maximum)
- 4 "Full Extended master" AS-Interface V3 actuator/sensor buses, profile M4.0

Depending on the model, Modicon M340 processors include:

- A 10BASE-T/100BASE-TX Ethernet Modbus/TCP port
- A CANopen machine and installation bus port
- A Modbus or Character mode Serial link port

Each processor has a USB TER port (for connecting a programming terminal or a Harmony HMI terminal) (2).

It is supplied with a memory card (3) that enables:

- Backing up the application (program, symbols and constants)
- Activating a standard Web server for the Transparent Ready class B10 integrated Ethernet port (depending on the model)

Depending on the model, this memory card can be replaced by another type of memory card (to be ordered separately) that supports:

- Backing up the application and activation of the standard Web server (same as other card)
- An 8 MB or 128 MB storage area, depending on the option card, for storing additional data organized in a file system (directories and sub-directories)

Modicon X80 module platform and additional modules (4)

The Modicon X80 module platform, which can be used in a local rack and/or in a remote I/O (RIO) drop depending on the type of automation platform (Modicon M340, Modicon M580, etc.), comprises the following elements:

- Racks with 4, 6, 8 or 12 slots (2a)
- Power supply modules, \square or \sim (2b)
- Discrete and analog I/O modules (2c)
- Communication modules, such as Ethernet (Modbus/TCP, EtherNet/IP), RTU (Remote Terminal Unit), Serial link, AS-Interface, etc. (2d)

Additional dedicated modules for the Modicon M340 automation platform that can be used on an Modicon X80 module platform are also available for application-specific purposes.

External modules, such as PROFIBUS DP communication as well as modules offered as part of TPP (Technology Partner Program) are also available.

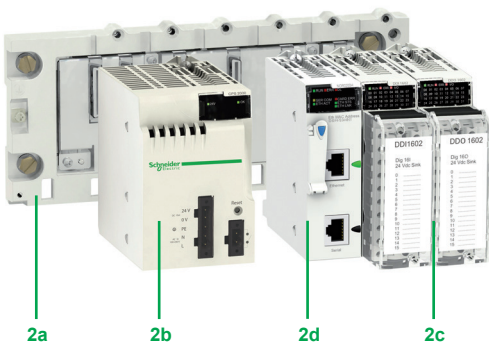

Modicon X80 module platform



Treatment for severe environments

Using the "ruggedized" modules enables the Modicon M340 automation platform to be used in severe environments or at extended operating temperatures from $-25^{\circ}\text{C}/-13^{\circ}\text{F}$ to $+70^{\circ}\text{C}/158^{\circ}\text{F}$. See pages 5/2 to 5/3.

(1) Maximum number of application-specific channels per station. Only the application-specific channels actually configured in the EcoStruxure Control Expert application account.
 (2) For details on the Harmony offer, please visit our website www.se.com.
 (3) With the exception of 2 models supplied without memory card (see page 2/6).
 (4) For further information, please consult our "Modicon X80 module platform" catalog.

Modicon M340 automation platform

Software configuration and multi-rack configuration



EcoStruxure Control Expert

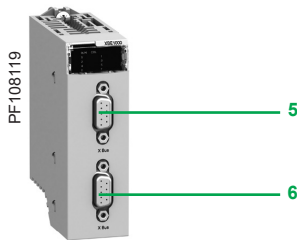
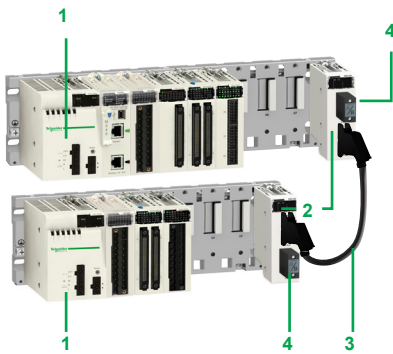

Rack expansion module BMXXBE1000



Line terminator TSXTLYEX

Presentation (continued)

Design and setup of Modicon M340 applications

Setting up Modicon M340 automation platform processors requires the use of EcoStruxure Control Expert (1), the common configuration software for all Modicon PAC products.

The function block software libraries provide Modicon M340 processors with the processing capability to meet the specialized requirements within the motion control with multiple independent axis functions domain (MFB "Motion Function Blocks" library). The axes are controlled by Altivar variable speed drives or Lexium servo drives connected on the CANopen machine bus.

Composition of a multi-rack configuration

Multi-rack configurations are made up of standard **BM●XBP●●00** racks. They comprise:

- 2 racks maximum for a station with **BMXP341000** processor (2)
- 4 racks maximum for a station with **BMXP3420●●●** or **BMXP3420●●●CL** processor (2)

Each rack is equipped with:

- 1 A **BMXCPS●●●●●** power supply
- 2 A **BMXXBE1000** rack expansion module. This module, inserted in the right-hand end of the rack (**XBE** slot) does not occupy rack slots **00...11** (4, 6, 8 or 12 slots are still available). For further information, please consult our "Modicon X80 module platform" catalog available on our website www.se.com.

X-bus

The racks, distributed on the X-bus, are connected to each other by X-bus extension cordsets **3** with a total length of **30 m/98.42 ft maximum**.

The racks are connected in a daisy chain using **BMXXBC●●0K** (3) X-bus extension cordsets connected to the two 9-way SUB-D connectors **5** and **6** on the front panels of the **BMXXBE1000** rack expansion modules **2**.

Line terminators 4

Both expansion modules at the ends of the daisy chain must have a line terminator **4 TSXTLYEX** on the unused 9-way SUB-D connector.

Cybersecurity

Schneider Electric has always taken care of the security of its systems. Security guidelines are available for our customers to ensure their systems are protected from attacks.

The Modicon M340 is a cybersecure platform thanks to its advanced built-in cybersecurity features and robustness.

The Modicon M340 automation platform also offers the following features:

- Protection against unauthorized remote connections via an online editable Access Control List
- Protection against remote programming changes via a password
- Option to enable or disable HTTP or FTP services
- Integrity of EcoStruxure Control Expert executable files
- Unnecessary services disabled by default
- Security features enabled by default

(1) EcoStruxure Control Expert replaces former Unity Pro software.

(2) The processor module is always positioned in the rack at address 0. However, in an X-bus daisy chain, the order of the racks has no effect on operation; the order of the daisy chain could be, for example 0-1-2-3, 2-0-3-1, 3-1-2-0, etc.

(3) Extension cordsets **BMXXBC●●0K** in lengths of 0.8 m/2.62 ft, 1.5 m/4.92 ft, 3 m/9.84 ft, 5 m/16.40 ft or 12 m/39.37 ft with elbowed connectors or **TSXCBY●08K** in lengths of 1 m/3.28 ft, 3 m/9.84 ft, 5 m/16.40 ft or 12 m/39.37 ft, 18 m/59.05 ft ou 28 m/91.86 ft with straight connectors.

Selection guide page 2/2

M340 processor offer

- **Presentation, description** page 2/4
- **Memory structure** page 2/5
 - Memory cards page 2/5
 - Protecting the application page 2/5
 - Modifying the program in online mode page 2/5
- **References** page 2/6



Modicon M340 automation platform

Modicon M340 processors

Modicon M340 automation platform

Standard processor Performance processors with or without memory card



Racks		Max number of local racks (main + extension)
I/O	In-rack	Max number of discrete I/O (1) (2)
		Max number of analog I/O (1) (2)
	Distributed	Max number of devices on CANopen bus
		Max number of devices on Ethernet Modbus/TCP (3)
		Max number of devices on Modbus link
Integrated communication ports		
		Ethernet Modbus/TCP network (RJ45)
		CANopen master (9-way SUB-D)
		Serial link (Modbus and Character) (RJ45)
		USB type mini B port
Communication modules	Ethernet	Max number (4)
		- Modbus/TCP
		- FactoryCast Modbus/TCP
		- EtherNet/IP and Modbus/TCP
		- RTU (DNP3 / IEC 60870-5-101/104)
		AS-Interface
		Max number
		- AS-Interface Master
		Serial Link (Modbus and Character)
		Max number
		- Serial link
Application-specific channels		
		Max number (5)
		- Counter module
		- Motion control module
		- Serial link (Process or RTU) module or processor integrated serial link
Internal memory capacity (on processor)		
		Internal user RAM
		- Program, constants, and symbols
		- Located/unlocated data
Memory card capacity		
		Backup of program, constants and symbols
		Hosting and display of user Web pages
		File storage
No. of K instructions executed per ms		
		100% Boolean (Kinstr/ms)
		65% Boolean + 35% fixed arithmetic (Kinstr/ms)
References		
Pages		

2 racks	4 racks
512 channels	1024 channels
128 channels	256 channels
Via network module (63 devices with I/O scanning function)	
32 devices	
1 in RTU/ASCII Modbus master/slave mode or in Character mode (non-isolated RS232/RS485, 0.3...38.4 Kbps)	
1 port for engineering console programming (EcoStruxure Control Expert) or HMI connection	
2 modules	
BMXNOE0100	
BMXNOE0110	
BMXNOC0401	
BMXNOR0200H	
2 modules	4 modules
BMXEIA0100	
Shared with other cumulative application-specific channels	
BMXNOM0200 (2-channel)	
20 channels	36 channels
BMXEHC0200 2-channel (60 kHz) module, BMXEHC0800 8-channel (10 kHz) module	
BMXMSP0200 2-channel (200 kHz) PTO (Pulse Train Output) module for servo drives	
BMXP34000 Processor with integrated 1 serial channel, BMXNOM0200 2-channel serial module, BMXNOR0200H module with integrated 1 RTU serial channel	
2048 KB	4096 KB
1792 KB	3584 KB
128 KB	256 KB
8 MB as standard	
(6)	
8 or 128 MB (according to BMXRMS08MPF option card)	
5.4 Kinstructions/ms	8.1 Kinstructions/ms
4.2 Kinstructions/ms	6.4 Kinstructions/ms
BMXP341000	BMXP342000
2/5	

(1) Local X80 I/O are localized in local racks (main or extension).
 (2) Maximum number of discrete and analog application-specific I/O channels is not cumulative.
 (3) Via network module
 (4) Maximum number of Ethernet modules is cumulative with different Ethernet communication modules
 (5) Maximum number of application-specific channels is cumulative with channels in counter module, motion control module, serial link modules and processor integrated serial link.
 (6) User Web pages with BMXNOE0110 Ethernet FactoryCast module (12 MB available).

Performance processors with or without memory card



4 racks				
1024 channels				
256 channels				
63 devices	-		63 devices	
Via network module (63 devices with I/O scanning function)				
32 devices				
		1 x 10BASE-T/100BASE-TX (Modbus/TCP, BOOTP/DHCP, FDR client, e-mail notification, class B10 standard web server)		
		1 (63 slaves, 50...1000 Kbps, class M20)		
		1 in RTU/ASCII Modbus master/slave mode or in Character mode (non-isolated RS232/RS485, 0.3...38.4 Kbps)		
		1 port for engineering console programming (EcoStruxure Control Expert) or HMI connection		
2 modules				
BMXNOE0100				
BMXNOE0110				
BMXNOC0401				
BMXNOR0200H				
4 modules				
BMXEIA0100				
Shared with other cumulative application-specific channels				
BMXNOM0200 (2-channel)				
36 channels				
BMXEHC0200 2-channel (60 kHz) module, BMXEHC0800 8-channel (10 kHz) module				
BMXMSP0200 2-channel (200 kHz) PTO (Pulse Train Output) module for servo drives				
BMXP34000 Processor with integrated 1 serial channel, BMXNOM0200 2-channel serial module, BMXNOR0200H module with integrated 1 RTU serial channel				
4096 KB				
3584 KB				
256 KB				
8 MB as standard		Supplied without card		8 MB as standard
(6)				
8 or 128 MB (according to BMXRMS08MPF option card)				
8.1 Kinstructions/ms				
6.4 Kinstructions/ms				
BMXP3420102	BMXP3420102CL	BMXP342020	BMXP3420302	BMXP3420302CL
2/5				

(1) Local X80 I/O are localized in local racks (main or extension).
 (2) Maximum number of discrete and analog application-specific I/O channels is not cumulative.
 (3) Via network module
 (4) Maximum number of Ethernet modules is cumulative with different Ethernet communication modules
 (5) Maximum number of application-specific channels is cumulative with channels in counter module, motion control module, serial link modules and processor integrated serial link.
 (6) User Web pages with BMXNOE0110 Ethernet FactoryCast module (12 MB available).

Presentation

Dedicated processors **BMXP34●●●●●**, which form part of a Modicon M340 automation platform, are available in two types:

- Standard type processor
- Performance type processor

The main differences between these 2 types of processor are:

- Their number of I/O
- Their memory capacity
- The types of communication ports integrated in each model

Description of processors

BMXP34●●●●● single-format processors feature the following parts:

- 1 Safety screw for locking the module in its slot (marked 0) in the rack.
- 2 A display block comprising from 5 to 10 LEDs, depending on the model
 - Common LEDs
 - Run LED (green): processor in operation (program execution)
 - ERR LED (red): processor or system fault
 - I/O LED (red): I/O module fault
 - SER COM LED (yellow): activity on the Modbus serial link
 - CARD ERR LED (red): memory card missing or faulty
 - Specific LEDs depending on the model
 - CAN RUN LED (green): integrated CANopen bus operational (**BMXP3420102**, **BMXP3420102CL**, **BMXP3420302**, and **BMXP3420302CL** models only)
 - CAN ERR LED (red): integrated CANopen bus fault (**BMXP3420102**, **BMXP3420102CL**, **BMXP3420302**, and **BMXP3420302CL** models only)
 - ETH ACT LED (green): activity on the Ethernet Modbus/TCP network (**BMXP342020**, **BMXP3420302**, and **BMXP3420302CL** models only)
 - ETH STS LED (green): Ethernet Modbus/TCP network status (**BMXP342020**, **BMXP3420302**, and **BMXP3420302CL** models only)
 - ETH 100 (red): Ethernet Modbus/TCP data rate (10 or 100 Mbps) (**BMXP342020**, **BMXP3420302**, and **BMXP3420302CL** models only)
- 3 A mini B USB connector for a programming terminal (or Harmony HMI terminal) (1).
- 4 A slot equipped with its Flash memory card (2) for backing up the application (a LED, located above this slot, indicates recognition of or access to the memory card).

In addition, depending on the model:

- 5 An RJ45 connector for Modbus serial link or Character mode link (RS 232C/RS 485, 2-wire, non-isolated) for **BMXP341000**, **BMXP342000**, **BMXP3420102**, **BMXP3420102CL**, and **BMXP342020** models
- 6 An RJ45 connector for connection to the 10BASE-T/100BASE-TX Ethernet Modbus/TCP network for **BMXP342020**, **BMXP3420302**, and **BMXP3420302CL**.
- 7 A 9-way SUB-D connector for the integrated CANopen master bus for **BMXP3420102**, **BMXP3420102CL**, **BMXP3420302**, and **BMXP3420302CL** models.
- 8 (on the rear) 2 rotary switches for selecting the IP address assignment method for the module

USB terminal port

The USB port **3**, offering a useful data rate of 12 Mbps, is compatible with EcoStruxure Control Expert programming software, the OPC Factory Server (OFS), and Harmony HMI terminals.

All **BMXP34●●●●●** processors can be connected to a USB bus comprising several peripheral devices. However:

- Only one processor can be connected to the USB bus
- No device on the USB bus can be controlled by the PLC (modem, printer)

1) For more detailed information, please refer to our website www.se.com.

2) Except for model **BMXP3420102CL**, which is supplied without memory card.

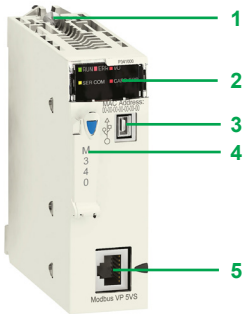

BMXP341000/2000

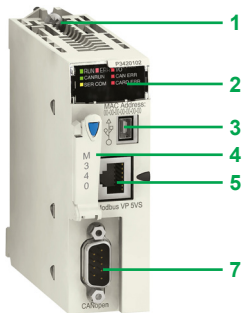

BMXP3420102/BMXP3420102CL

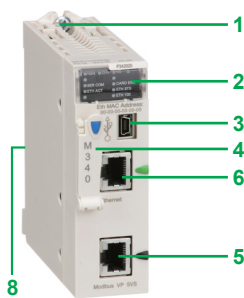

BMXP342020

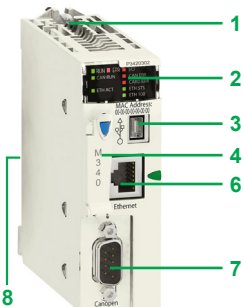

BMXP3420302/BMXP3420302CL

Memory cards**BMXRMS008MP memory card (included as standard)**

Modicon M340 processors are supplied as standard (1) with an SD (*Secure Digital*) type Flash memory card, formatted by Schneider Electric and referenced **BMXRMS008MP** as a replacement part. This card is intended for backing up the two memory areas on the processor internal RAM:

- Program, symbols and comments area, which contains the executable binary code and the IEC source code of the application program for the program part
- Constant area, which contains the constant data located by address.

The data is backed up automatically by duplication, when the PLC is turned off. Likewise, data restoration is transparent for the user, on return of power.

Capacity of the backup area on the memory card:

- 1792 KB for the **BMXP341000** Standard processor
- 3584 KB for the **BMXP342●●●●** Performance processors

BMXP342020/20302/20302CL processors with an integrated Ethernet port have an additional 2 MB memory area specifically for Standard Web services (Transparent Ready B10) (see [page 3/8](#)).

BMXRMS008MPF/128MPF optional memory cards

BMXP342●●●● Performance processors can take a **BMXRMS008MPF** or **BMXRMS128MPF** optional memory card, with greater memory capacity, in place of the standard memory card. These cards also provide a file storage area with a maximum capacity of 8 MB (for the **BMXRMS008MPF** card) or 128 MB (for the **BMXRMS128MPF** card).

This file storage area enables:

- Any user-defined Word, Excel, PowerPoint or Acrobat Reader document to be received via FTP (for example, maintenance manuals, diagrams, etc.)
- Additional data to be stored via EFB user function blocks (for example: production data, manufacturing recipes, etc.)

EcoStruxure Control Expert programming software helps the application designer manage the structure and memory space occupation of the Modicon M340 automation platform.

Protecting the application

If necessary, it is possible to prohibit access to the application in terms of reading and modifying the program by only loading the executable code in the PLC.

Additionally, a memory protection bit, set in configuration mode, is also available to prevent any program modification (via the programming terminal or downloading).

With EcoStruxure Control Expert, the user has function blocks for protecting know-how by means of a signature that can be loaded and stored in the M340 processor flash memory card (code not executed if the signature is not present).

Program modification in online mode

The online program modification function is available on the Modicon M340 automation platform with EcoStruxure Control Expert software. Program code and data can be added or modified in different places in the application in a single modification session, thus ensuring modification is homogenous and consistent with the controlled process.

A dedicated memory area of the application internal RAM authorizes these program modification or addition sessions while complying with the recommendation to structure the application program in several, reasonably-sized sections.

Modicon M340 automation platform

M340 Processors

2



BMXP341000



BMXP342000



BMXP3420102/20102CL
BMXP3420302/20302CL



BMXP342020

Modicon M340 processors					
I/O capacity	Max. no. of communication modules	Integrated communication ports	Memory card	Reference	Weight kg/lb
Standard BMXP3410, 2 racks					
512 discrete I/O 128 analog I/O 20 application-specific channels	2 Ethernet modules 2 AS-Interface modules	Modbus serial link	Included	BMXP341000	0.200/ 0.441

Performance BMXP3420, 4 racks					
1024 discrete I/O 256 analog I/O 36 application-specific channels	2 Ethernet modules 4 AS-Interface modules	Modbus serial link	Included	BMXP342000	0.200/ 0.441
		Modbus serial link CANopen bus	Included	BMXP3420102 (1)	0.210/ 0.463
			Not included (2)	BMXP3420102CL (1)	0.210/ 0.463
		Modbus serial link Ethernet Modbus/TCP	Included	BMXP342020	0.205/ 0.452
		CANopen bus Ethernet Modbus/TCP	Included	BMXP3420302 (1)	0.215/ 0.474
			Not included (2)	BMXP3420302CL (1)	0.215/ 0.474

(1) **BMXP3420102/20302** processors, combined *EcoStruxure Control Expert* software, can be used to customize configuration of the device *Boot Up* procedure compatible with all CANopen third-party products.
 (2) These products are supplied without integrated memory card. The memory card must be ordered separately.

Accessories

Memory cards

Description	Use	Capacity	Reference	Weight kg/ lb
Standard flash memory card included as standard with processor (1)	- Backup of program, constants, symbols and data - Activation of class B10 Web server	8 MB	BMXRMS008MP	0.002/ 0.004
Optional flash memory card	- Backup of program, constants, symbols and data - Activation of class B10 Web server - File storage	8 MB + 8 MB file storage	BMXRMS008MPF	0.002/ 0.004
		8 MB + 128 MB file storage	BMXRMS128MPF	0.002/ 0.004



BMXRMS008/128MPF



BMXXCAUSBH0●●

Cordsets

Description	Use	Length m/ ft	Reference	Weight kg/ lb
USB PC or terminal connecting cable for processor	For connection: - From Mini B USB port on the Modicon M340 processor - To Type A USB port on PC terminal or Harmony HMI	1.8/	BMXXCAUSBH018	0.065/
		5.91		0.143
		4.5/ 14.76	BMXXCAUSBH045	0.110/ 0.243

(1) This memory card will not be provided if order BMXP3420102CL or BMXP3420302CL processor.

Industrial Ethernet services

- Modicon M340 communication services [page 3/2](#)
- Modicon M340 web services [page 3/8](#)

CANopen machine and installation bus

- Presentation [page 3/12](#)
- Connectable devices [page 3/13](#)
- Description, references [page 3/14](#)
- Connections [page 3/15](#)
- Cabling system, references [page 3/16](#)

Modbus and Character mode serial links

- Presentation, description [page 3/18](#)
- Characteristics, references [page 3/19](#)

Communication modules

Communication selection guide [page 3/20](#)

■ Modbus/TCP and EtherNet/IP communication

- Processors, presentation and references [page 3/24](#)
- Ethernet modules, presentation and references [page 3/25](#)

■ RTU communication

- RTU communication protocols [page 3/28](#)
- RTU module, presentation [page 3/29](#)
- RTU module, references [page 3/31](#)



Modicon M340 automation platform

Industrial Ethernet services

Modicon M340 communication services

Presentation

BMXP342020/20302/20302CL processors via their integrated Ethernet port, **BMXNOE0100/0110** and **BMXNOC0401** Ethernet modules and the **BMXNOR0200H** RTU module provide transparent communication on the Ethernet Modbus/TCP network using Transparent Ready communication services.

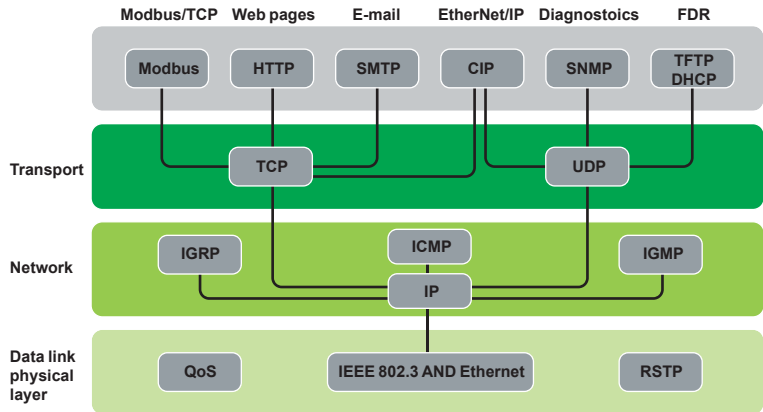

Ethernet communication services for the BMXNOE0100/0110 module

The following Transparent Ready communication services are designed for use in automation applications. They supplement the universal Ethernet services (HTTP, BOOTP/DHCP, FTP, etc):

- Modbus/TCP messaging for class 10 or 30 devices
- I/O Scanning service for class 30 devices
- FDR (Faulty Device Replacement) for class 10 or 30 devices
- SNMP (*Simple Network Management Protocol*) network management for class 10 or 30 devices
- Global Data, for class 30 devices
- Bandwidth management for class 10 or 30 devices
- NTP (*Network Time Protocol*) synchronization for class 30 devices
- E-mail alarm notification via SMTP server, via Unity Pro function block

Note: See selection guide on pages 3/20 and 3/21 for the communication services supported by **BMXP342020/20302/20302CL** processors, **BMXNOE0100/0110** network modules and the **BMXNOR0200H** RTU module on the Modicon M340 platform.

The following pages (3/3 to 3/7) present the various options available through all of these services in order to facilitate the optimum choice of solutions when defining a system integrating Transparent Ready devices.

Functions

Ethernet universal services

HTTP (*HyperText Transfer Protocol*)

- This protocol is used for transmitting Web pages between a server and a browser.
- Web servers embedded in Transparent Ready automation products provide easy access to products located anywhere in the world from a standard web browser such as Internet Explorer.

BOOTP/DHCP (RFC1531)

- These protocols are used to provide devices with IP parameters automatically. This avoids having to manage each device address individually by transferring this management to a dedicated IP address server.
- The DHCP protocol (*Dynamic Host Configuration Protocol*) is used to assign configuration parameters to devices automatically. DHCP is an extension of BOOTP.
- Schneider Electric devices can be “*BOOTP clients*” (used to retrieve the IP address automatically from a server) or “*BOOTP servers*” (allowing the device to distribute IP addresses to the network stations).
- Schneider Electric uses standard BOOTP/DHCP protocols for its FDR (*Faulty Device Replacement*) service.

FTP (*File Transfer Protocol*) (RFCs 959, 2228, and 2640)

- This protocol provides the basic elements for file sharing. Many systems use it to exchange files between devices.

TFTP (*File Transfer Protocol*) (RFCs 959, 2228, and 2640):

- This network transfer protocol can be used to connect to a device and download code to it.
- For example, it can be used to transfer a boot code to a workstation without a disk drive or to connect and download updates of network device firmware.
- Transparent Ready devices implement FTP and TFTP for transferring certain information to or from devices, in particular for downloads of firmware or user-defined Web pages.

SNMP (*Simple Network Management Protocol*) (RFCs 1155, 1156 and 1157)

- The SNMP standard manages the various network components via a single system.
- The network management system can exchange data with SNMP agent devices. This function allows the manager to display the status of the network and devices, modify their configuration and feed back alarms in the event of a fault.
- Transparent Ready devices are SNMP-compatible and can be integrated naturally in a network managed via SNMP.

COM/DCOM (*Distributed Component Object Model*) (RFCs 1155, 1156 and 1157)

- COM/DCOM or OLE (*Object Linking and Embedding*) protocol is the name of the technology consisting of Windows objects which enables transparent communication between Windows applications.
- These technologies are used in the OFS (*OLE for Process Control Factory Server*) data server software.

Modbus standard communication protocol

Modbus protocol, the industry communication standard since 1979, has been combined with Ethernet Modbus/TCP, the medium for the Internet revolution, to form Modbus/TCP, a completely open Ethernet protocol. The development of a connection to Modbus/TCP does not require any proprietary component, nor purchase of a license. This protocol can easily be combined with any product supporting a standard TCP communication stack. The specifications can be obtained free of charge from the following website: www.modbus.org.



Functions (continued)

I/O Scanning service

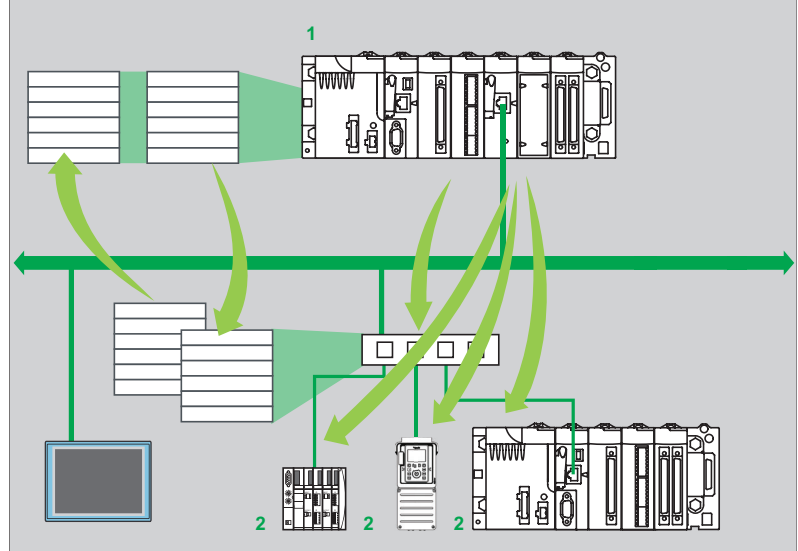

The I/O Scanning Service is used to manage the exchange of remote I/O states on the Ethernet network after a simple configuration operation, with no need for special programming:

- I/O scanning is performed transparently by means of read/write requests according to the Modbus client/server protocol on the TCP profile (1, Modicon M340 with I/O Scanning service).
- This principle of scanning via a standard protocol enables a device with the I/O Scanning service to communicate with any device supporting Modbus/TCP messaging in server mode (2).

This service can be used to define:

- A word zone reserved for reading inputs
- A word zone reserved for writing outputs
- Refresh periods independent of the PLC scan

During operation, the module:

- Manages TCP connections with each remote device
- Scans devices and copies the I/O to the configured word zone
- Feeds back status words used to check that the service is working correctly from the PLC application
- Applies pre-configured fallback values if a communication problem occurs

A range of hardware and software products is available enabling the I/O Scanning protocol to be implemented on any type of device that can be connected to the Ethernet network.

Please consult the Modbus Organization website: www.modbus.org.

Characteristics

- Each Modicon M340 station can exchange a maximum of 100 words for writing and 125 words for reading.
- Maximum size in the Modicon M340 PLC that manages the service (64 stations max.) with **BMXNOE0100/0110** and **BMXNOC0401** network modules: 2 Kwords (input) and 2 Kwords (output).

I/O Scanning service diagnostics

I/O Scanning service diagnostics can be performed in one of five ways:

- Via the application program from a specific PLC data zone
- From the setup software debug screen
- From the PLC system diagnostic function displayed by means of an internet browser on a PC station
- Using standard SNMP manager software

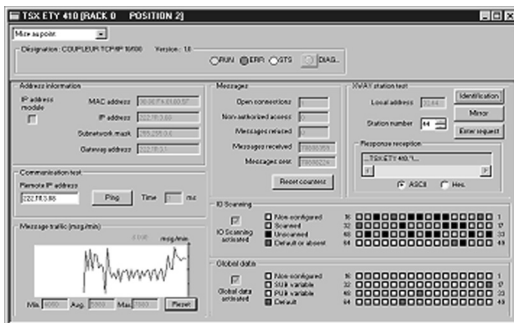

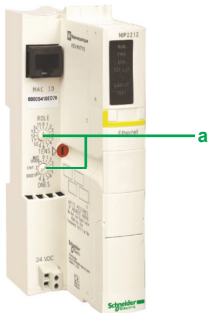

NIM network module for Modicon STB I/O

Functions (continued)

FDR (Faulty Device Replacement) service

The Faulty Device Replacement service uses standard address management technologies (BOOTP, DHCP) and the TFTP (*Trivial File Transfer Protocol*) file management service, with the aim of simplifying maintenance of Ethernet devices. The FDR service is used to replace a faulty device with a new device with the guarantee that it will be detected, reconfigured and automatically rebooted by the system.

The main steps in replacement are:

- 1 A device using the FDR service malfunctions.
- 2 Another similar device is taken from the maintenance store, preconfigured with the Device name for the faulty device, then reinstalled on the network. Depending on the device, addressing can be performed using rotary selector switches (as for Modicon STB distributed I/O **a** for example) or can be given using the keypad integrated in the device (as for Altivar variable speed drives for example).
- 3 The FDR server detects the new device, allocates it an IP address and transfers the configuration parameters to it.
- 4 The substituted device checks that all these parameters are indeed compatible with its own characteristics and switches to operational mode.

The FDR server can be **BMXNOE0100/0110** or **BMXNOC0401** Ethernet modules.



NTP Configuration

NTP Server Configuration

IP Address of Primary NTP Server:

IP Address of Secondary NTP Server:

Polling Period: sec

Time Zone

(GMT-05:00)Eastern Standard Time(New York)

Automatically adjust clock for daylight saving change

NTP time synchronization service

Presentation

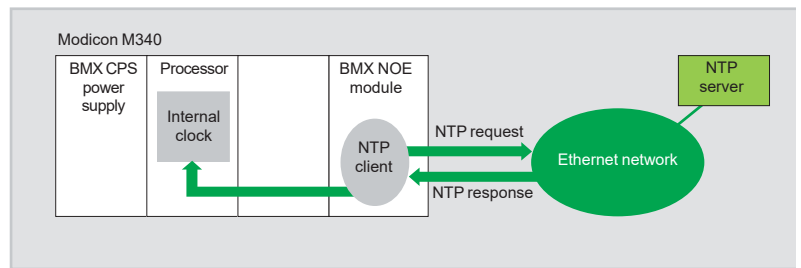

The time synchronization service is based on NTP (*Network Time Protocol*) which is used to synchronize the time of a client or a server on Ethernet from a server or another reference time source (radio, satellite, etc).

Operation

BMXNOE0100/0110, **BMXNOC0401** and **BMXNOR0200H** Ethernet Modbus/TCP modules have a NTP client component.

These modules connect to an NTP server using a client request (*Unicast*) in order to update their local time. The module clock is updated periodically (1 to 120 s) with typical precision of 5 ms. If the NTP server cannot be reached, the Ethernet TCP/IP module switches to a standby NTP server.

The PLC processor clock is therefore itself updated with a precision of 5 ms. A function block is used to read this clock, thus enabling Unity Pro application events or variables to be time and date stamped.

The Ethernet module is configured by means of a Web page. The time zone can be configured. A time synchronization service (NTP) diagnostic Web page is also available.

Information on the time synchronization service (NTP) is also available in the Transparent Ready private MIB, which can be accessed via the SNMP network management service.

NTP Diagnostics

NTP Status:

NTP Server Status

Link to the NTP Server: Server Time Quality within microsec

Server: Primary

NTP Request Statistic

Number of Requests: Number of Errors:

Number of Responses: Last Error:

NTP Data and Time

Date: Time: DST Status:

Time Zone: ((GMT-05:00)Eastern Standard Time(New York))

Functions (continued)

Global Data service

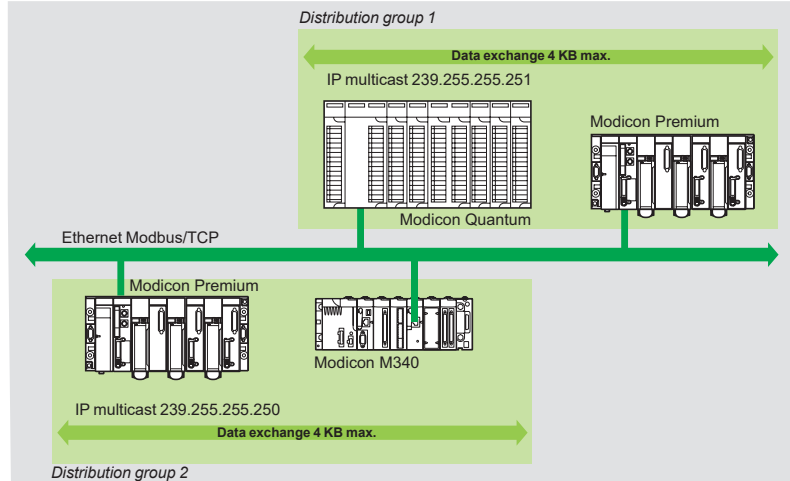

The Global Data service performs data exchanges in real time between stations belonging to the same distribution group. It is used to synchronize remote applications, or to share a common database between a number of distributed applications. Exchanges are based on a standard producer/consumer protocol, guaranteeing optimum performance with a minimum load on the network. This RTPS (*Real Time Publisher Subscriber*) protocol is promoted by Modbus Organization (*Interface for Distributed Automation*), and is already a standard adopted by several manufacturers.

Characteristics

A maximum of 64 stations can participate in Global Data within a single distribution group. Each station can:

- Publish one 1024-byte variable. The publication period can be configured from 1 to n processor master task (*Mast*) periods.
- Subscribe to between 1 and 64 variables. The validity of each variable is controlled by status bits (*Health Status bits*) linked to a refresh timeout configurable between 50 ms and 1s. Access to an element of the variable is not possible. The total size of subscribed variables amounts to 4 K contiguous bytes.

To further optimize the performance of the Ethernet network, Global Data can be configured with the “multicast filtering” option which, together with switches, broadcasts data only to Ethernet ports where there is a Global Data service subscriber station. If these switches are not used, Global Data is sent in “multicast” mode to all switch ports.

Global Data service diagnostics

The diagnostic screens use a colour code to show the Global Data status:

- Configured/not configured/faulty.
- Published/subscribed.

Global Data service diagnostics can be performed in one of five ways:

- Via the application program from a specific PLC data zone.
- From the setup software debug screen.
- From the PLC system diagnostic function displayed by means of an internet browser on a PC station.
- Using standard SNMP manager software.

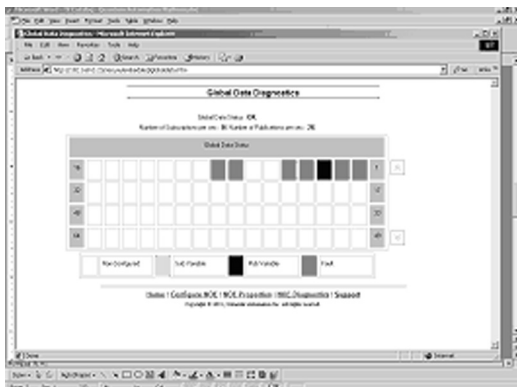

Functions (continued)

SNMP network management service

From a network management station, SNMP (*Simple Network Management Protocol*) monitors and checks all components of the Ethernet architecture and thus ensures quick diagnostics in the event of a problem.

It is used to:

- Interrogate network components such as computer stations, routers, switches, bridges or terminal devices in order to view their status.
- Obtain statistics about the network to which the devices are connected.

This network management software complies with the conventional client/server model. However, to avoid confusion with other communication protocols that use this terminology, we talk instead about:

- Network manager for the client application that operates on the computer station.
- SNMP agent for the network device server application.

Transparent Ready devices can be managed by any SNMP network manager, including HP Openview and IBM Netview.

Standard SNMP (*Simple Network Management Protocol*) is used to access configuration and management objects contained in the device MIBs (Management Information Bases). These MIBs must comply with certain standards to be accessed by any commercially-available manager, but depending on the complexity of products, manufacturers can add certain objects to private databases.

The Transparent Ready private MIB presents management objects specific to the Schneider Electric offer. These objects simplify the installation, setup and maintenance of Transparent Ready devices in an open environment using standard network management tools.

Transparent Ready devices support 2 levels of SNMP network management:

- The Standard MIB II interface: This interface accesses a first level of network management. It enables the manager to identify the devices making up the architecture and retrieve general information about the configuration and operation of Ethernet Modbus/TCP interfaces.
- The Transparent Ready MIB interface: This interface improves the management of Transparent Ready devices. This MIB has a set of data enabling the network management system to supervise all the Transparent Ready services.

The Transparent Ready MIB can be downloaded from the FTP server of any Transparent Ready Ethernet module in a PLC.

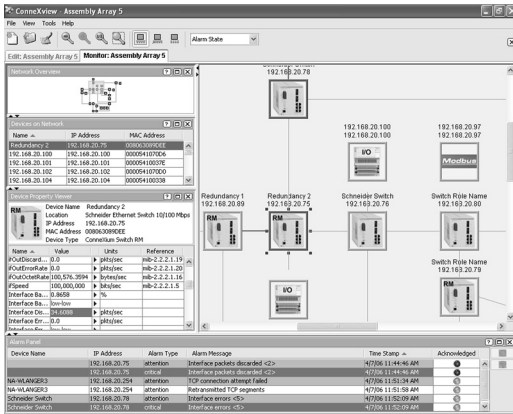

Automatic recognition of IP devices via the ConneXview diagnostic software for Ethernet industrial networks



Modicon M340 automation platform

Industrial Ethernet services

Modicon M340 standard Web services

Presentation of Web services

The standard Web server functions are integrated in a wide variety of Schneider Electric Ethernet products: Modicon automation platform processors and Ethernet modules, distributed I/O modules, variable speed drives and gateways. These functions are mainly integrated in **BMXP342020/20302/20302CL** processors, **BMXNOE0100/0110** and **BMXNOC0401** Ethernet modules, and **BMXNOR0200H** RTU module.

From a simple Internet browser, the standard Web server authorizes the following “ready-to-use” functions:

- Remote diagnostics and maintenance of products
- Display and adjustment of products (read/write variables, status)

With the **BMXNOE0110** FactoryCast module equipped as standard with the **BMXRWSFC032M** card, the Web server also offers the following functions:

- Management of PLC system and application alarms with partial or total acknowledgement (ready-to-use Alarm Viewer function pages)
- Hosting and display of Web pages created by the user

The embedded Web server is a real-time data server. All the data can be presented in the form of standard Web pages in HTML format and can therefore be accessed using any Web browser that supports the embedded Java code. The standard functions provided by the Web server are supplied “ready-to-use” and thus do not require any programming of either the PLC or the client PC device supporting a Web browser.

Modicon M340 automation platform

Industrial Ethernet services
M340 Standard Web server



Modicon M340 hardware configuration

Standard Web server on the Modicon M340 platform

Rack Viewer PLC diagnostics function

The Rack Viewer function can be used for PLC system and I/O diagnostics. It displays the following in real time:

- Status of LEDs on the PLC front panel
- The PLC type and version
- Hardware configuration of the PLC including status of the system bits and words
- Detailed diagnostics of:
 - Each of the I/O module channels or application-specific channels in the configuration
 - Devices connected to the CANopen bus

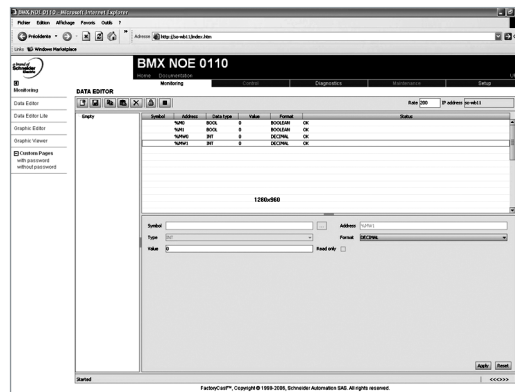

Data Editor variables table

Data Editor read/write function for PLC data and variables

The Data Editor function can be used to create tables of animated variables for real-time read/write access to PLC data in the form of lists.

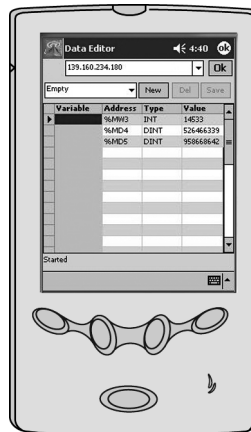

Various animation tables containing specific application variables to be monitored or modified can be created by the user and saved in the standard Web server module. In addition to the functions provided by the standard Web server, the **BMXNOE0110** Ethernet module's FactoryCast Web server offers the following:

- Display of variables: Variables can be entered and displayed either in their symbolic form (S_Pump 234) or as their address (%MW99).
- Write access to variables: This can be enabled or disabled for each of the variables using the FactoryCast module configuration software.
- Read/write function: This can be used on tools such as a pocket PC or PDA terminal.

Modicon M340 automation platform

Industrial Ethernet services
FactoryCast Web services

3

BMXNOE0100 module FactoryCast Web server

In addition to the standard services, the embedded Web server in the **BMXNOE0110** FactoryCast module offers the functions described below.

Alarm Viewer function

The alarm viewer is a ready to use, password-protected function. It is used to process alarms (display, acknowledgement and deletion) managed at PLC level by the system or using diagnostic function blocks known as DFBs (system-specific diagnostic function blocks and application-specific diagnostic function blocks created by the user).

These alarms are stored in the diagnostic buffer managed by the Modicon M340 platform (dedicated memory space for storing all the diagnostic events). The diagnostic viewer is a Web page comprising a list of messages, which displays the following information for each alarm:

- Dates and times of the occurrence/removal of a fault
- Alarm message
- Alarm status
- Type of associated diagnostic function block (DFB)

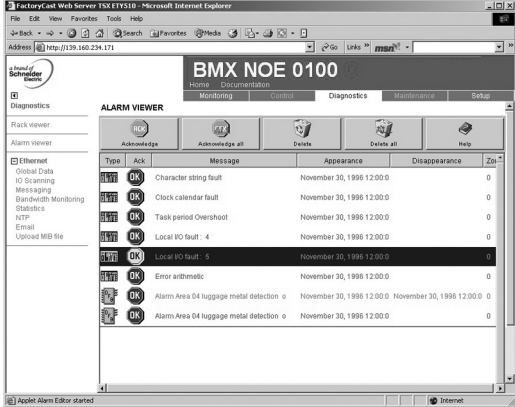

Alarm display from the diagnostic buffer

Graphic Data Editor function

This function is used to create the graphic views animated by the PLC variables that can be accessed via their address or via their symbol (access to located data). The ready-to-use graphic editor is available in online mode when connected to the **BMXNOE0110** module.

These views are created from a library of predefined graphic objects by simple copy/paste operations. The objects are configured to suit the user's requirements (colour, PLC variables, name, etc).

List of graphic objects available:

- Analog and digital indicators
- Horizontal and vertical bar charts
- Boxes for displaying messages and entering values
- Pushbutton boxes
- Trend recorders
- Vats, valves, motors, etc

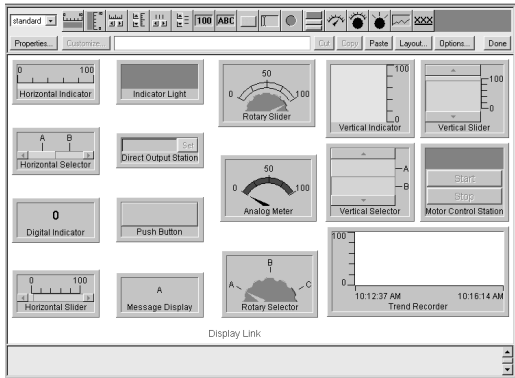

Library of predefined graphic objects

Customized graphic objects can be added to this list and can be reused in user Web pages that have been created using standard software for editing HTML pages. The views thus created are saved in the **BMXNOE0110** module and can be displayed using any Web browser.

User Web page hosting and display function

The **BMXNOE0110** FactoryCast module has a 16 Mbyte non-volatile memory which is accessed in the same way as a hard drive. This allows hosting of Web pages and any user-defined Word or Acrobat Reader document (for example, maintenance manuals, wiring diagrams, etc).

Web pages can be created using any standard tool for creation and editing in HTML format. They can be enhanced by inserting animated graphic objects linked to PLC variables. These animated objects are created using the Graphic Data Editor. They are then downloaded to the **BMXNOE0110** module via the FactoryCast Web server configuration software.

These user Web pages can be used, for example, to:

- Display and modify all PLC variables in real time
- Create hyperlinks to other external Web servers (documentation, suppliers, etc)

This function is particularly suitable for creating graphic interfaces used for the following purposes:

- Real-time display and supervision
- Production monitoring
- Diagnostics and help with maintenance
- Operator guides

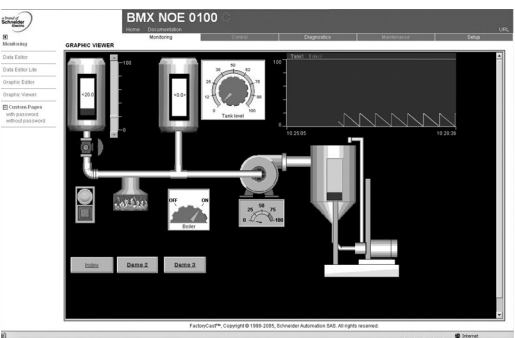

Real-time supervision graphic interface



Web Designer

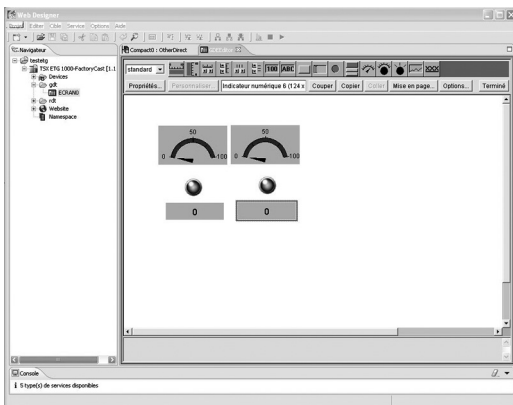

Graphic Data Editor

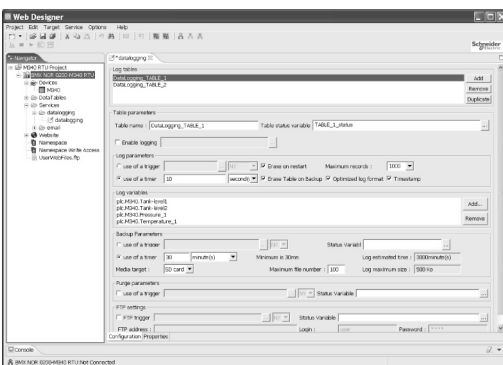

Configuring the Data Logging function for BMXNOR0200H module

Web Designer configuration software

The Web Designer software is supplied on CD-ROM with **BMXNOE0110** Ethernet module and **BMXNOR0200H** RTU module.

The software is used for the configuration and administration of the Web server embedded in the modules. It makes it easier to create customized Web human/machine interfaces (HMIs). It is also used for easy configuration of embedded advanced processing functions for numerous Web server modules and RTU modules. Web Designer software is compatible with Windows 32-bit operating systems. For optimum use, it requires Java Virtual Machine 1.4.2 minimum.

Web Designer software offers the following functions:

■ **Setting the Web Designer function parameters:**

- Definition of access security, passwords
- Importing of PLC symbol databases
- Definition of access to write-enabled variables

■ **Management of the Web site:**

- Management of default site Web pages
- Management of user site Web pages
- Graphic Data Editor for animating Web pages (*BMXNOE0110 module only*). This integrated editor can be used for easy customization of graphic objects: bar charts, gauges, LEDs, curves, cursors, operator input fields, alphanumeric display fields, buttons, etc.
- Downloading of Web pages between the PC and the module
- Debugging of Web pages in online mode or in simulation mode (including animations and Java beans)

■ **Simulation mode:**

- The application and the Web site (including the Java animations) can be set up in online mode or in simulation mode.
- Simulation mode is used to test the operation of the Web application without a module (with no physical connection to a PLC) thereby simplifying debugging.

■ **Creation of user Web pages:**

- User Web pages are created graphically using an external HTML editor (FrontPage or similar, not supplied).
- User Web pages created with the graphic editor are actual animated supervisory control screens and can be used to monitor the process. Based on Web technologies (HTML and Java), they provide real-time access to PLC variables using the FactoryCast library of graphic objects (Java beans) (*BMXNOC0401 module only*).

■ **Data Logging (for BMXNOR0200H module only):**

- This service is used to archive the application data: events, alarms, process data, device states, process values, etc.
- The data are logged in CSV files in ASCII format, which are stored locally on the SD memory card in the BMXNOR0200H module.

■ **Sending alarm notifications or reports via Email or SMS (BMXNOR0200H module only):**

- The BMXNOR0200H module can send e-mails or SMS messages automatically in real time in order to send alarm notifications, maintenance calls, production reports or factory status updates, etc to specified users.
- E-mails or SMS messages are sent when a predefined application or process is triggered.



Modicon M340 automation platform

CANopen machine and installation bus



Presentation

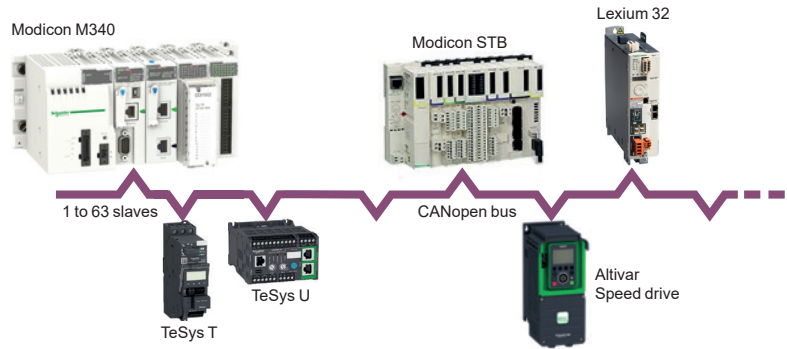

Schneider Electric has selected CANopen for its machines and installations because of its wealth of functions and its resulting benefits in the automation world. This decision was based on the general acceptance of CANopen, and the fact that CANopen products are increasingly used in control system architectures. CANopen is an open network supported by more than 400 companies worldwide, and promoted by CAN in Automation (CiA). CANopen conforms to standards EN 50325-4 and ISO 15745-2. Schneider Electric is heavily involved in working groups, which are important for machine and installation architectures, systems and products.

CANopen brings transparency to Ethernet

CAN in Automation and Modbus Organization have worked together to create a standard that ensures total transparency between CANopen and Modbus/TCP. The result of this collaboration has been the CiA DSP309-2 specification, which defines the communication standards between a Modbus/TCP network and a CANopen bus. The specification defines the mapping services which enable CANopen devices to communicate with a Modbus/TCP network through a gateway. The data in a CANopen device can be accessed in both read and write mode.

This specification is the first standard available for developing open standard communication between Modbus/TCP and CANopen. It is driving Schneider Electric network solutions toward better integration, diagnostics and configuration of distributed applications. It allows machines and installations to be connected to an Ethernet network continuously, while combining the advantages of each network in its specific area.

The CANopen bus is a multi-master bus which ensures reliable, deterministic access to real-time data in control system devices. The CSMA/CA protocol is based on broadcast exchanges, sent cyclically or on an event, to ensure optimum use of the bandwidth. A message handling channel can also be used to define slave parameters.

The bus uses a double shielded twisted pair on which, with the Modicon M340 platform, a maximum of 63 devices are connected by daisy-chaining or by tap junctions. The variable data rate between 20 Kbps and 1 Mbps depends on the length of the bus (between 2500 m and 200 m/8202 and 66 ft).

Each end of the bus must be fitted with a line terminator.

The Modicon M340 automation platform, via its **BMXP3420102/20302/20102CL/20302CL** processor with integrated CANopen link, performs the role of master on the bus.

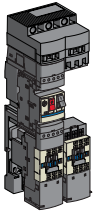

TeSys Quickfit



Altivar ATV320



Lexium 32



Modicon STB

Connectable Schneider Electric devices

The following Schneider Electric devices can be connected to the CANopen bus, depending on the model (1):

- Absolute encoders
- TeSys U starter-controllers with **LULC08** communication module
- TeSys T motor management system, with LTM controller
- TeSys D motor-starters using the TeSys Quickfit installation help system with **APP1CCO0/O2** communication module
- Modicon STB IP 20 modular distributed I/O, with STB NIM interface module
- Altivar 320 variable speed drives for asynchronous motors
- Lexium 32 servo drives for BMH and BSH servo motors
- IcLA intelligent compact motor-drives

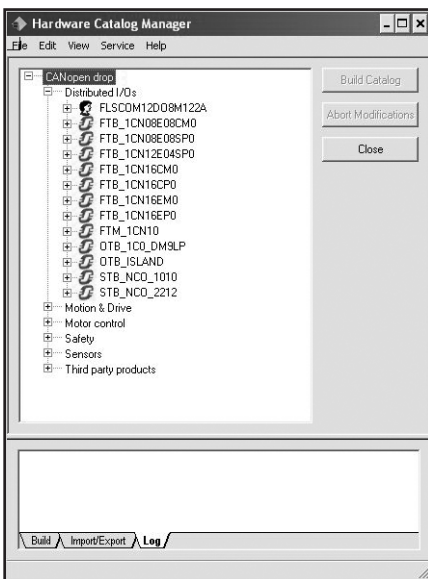

Hardware Catalog Manager for integration of third-party devices

Integration of third-party devices

EcoStruxure Control Expert offers the *Hardware Catalog Manager* tool which can be used to integrate third-party devices at an identical level to that of Schneider Electric devices. These third-party devices and their EDS file must conform to the CiA (*CAN In Automation*) standard.

The *Hardware Catalog Manager* tool is used to:

- Integrate third-party devices in Unity Pro
- Optimize the size of the **BMXP3420102/20302/20102CL/20302CL** processor memory area reserved for PDO (*Process Data Object*) process variables
- Customize the parameters specific to each third-party device

(1) See our website www.se.com for compatible device versions and their setup software.

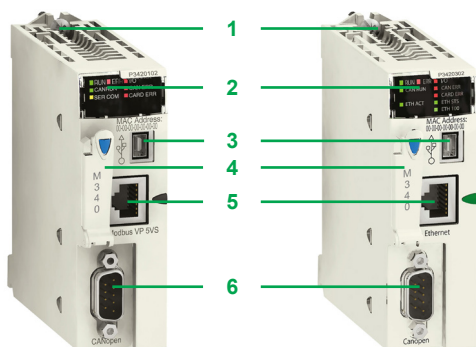

BMXP3420102
BMXP3420102CL

BMXP3420302
BMXP3420302CL

3

Description

BMXP3420102/20102CL and **BMXP3420302/20302CL** Performance processors on the Modicon M340 platform have an integrated CANopen communication port. They feature the following on the front panel:

- 1 A safety screw for locking the module in its slot in the rack, marked "00".
- 2 A display block comprising at least:
 - CAN RUN LED (green): Integrated machine/installation bus operational
 - CAN ERR LED (red): Integrated machine/installation bus fault
- 3 A mini B USB connector for a programming terminal
- 4 A slot equipped with Flash memory card for backing up the application (1)
- 5 An RJ45 connector for serial link (with **BMXP3420102/20102CL** model) or Ethernet Modbus/TCP port (with **BMXP3420302/20302CL** model)
- 6 A 9-way SUB-D connector for the CANopen master machine and installation bus

Complementary characteristics

The following characteristics complement those introduced in the communication selection guide on [page 3/20](#):

- Data rate: 20 Kbps to 1 Mbps
- Maximum length of CANopen bus (2):
 - 20 m/65.62 ft at 1 Mbps, 40 m/131.23 ft at 800 Kbps, 100 m/328.08 ft at 500 Kbps, 250 m/820.21 ft at 250 Kbps
 - 500 m/1640.42 ft at 125 Kbps, 1000 m/3280.83 ft at 50 Kbps, 2500 m/8202.08 ft at 20 Kbps
- Maximum length of tap-offs on one tap junction (3):
 - 0.6 m/1.97 ft at 1 Mbps, 6 m/19.68 ft at 800 Kbps, 10 m/32.81 ft at 500 Kbps, 10 m/32.81 ft at 250 Kbps
 - 10 m/32.81 ft at 125 Kbps, 120 m/393.70 ft at 50 Kbps, 300 m/984.25 ft at 20 Kbps
- Limitation per segment:
 - Max. number of products: 64 at 1 Mbps, 32 at 800 Kbps, 16 at 500 Kbps
 - Maximum length of segment (4): 160 m/524.93 ft at 1 Mbps, 185 m/606.95 ft at 800 Kbps, 205 m/672.57 ft at 500 Kbps

Modicon M340 Performance processors with integrated CANopen bus link

Modicon M340 processor modules are supplied with the Flash card **BMXRMS008MP** (1).

This card performs the following actions transparently:

- Backing up the application (program, symbols and constants) supported in the processor internal RAM that is not backed up
- Activation of the Transparent Ready class B10 standard web server (with **BMXP3420302/20302CL** processor)
- This card can be replaced by another card featuring a file storage option (see [page 2/7](#)).



BMXP3420102
BMXP3420102CL



BMXP3420302
BMXP3420302CL

I/O capacity	Max. no. of communication modules	Integrated communication ports	Reference	Weight kg/lb
Performance processors, 4 racks				
1024 discrete I/O	2 Ethernet modules	CANopen bus	BMXP3420102	0.210/
256 analog I/O	4 AS-Interface buses	Modbus serial link	BMXP3420102CL (1)	0.463
36 application-specific channels				
		CANopen bus	BMXP3420302	0.215/
		Ethernet Modbus/TCP	BMXP3420302CL (1)	0.474

(1) Memory card must be ordered separately for the **BMXP3420102CL/302CL** processors (see [page 2/7](#)).

(2) Deduct 15 m/49.21 ft per repeater from the length of the bus.

(3) For other restrictions, please refer to the CANopen hardware setup manual available on our website www.se.com.

(4) With the use of TSXCANC●50/100/300 CANopen cables and TSXCANC●DD03/1/3/5 preformed cordsets.

(5) See "Integration of third-party devices" paragraph on [page 3/13](#).

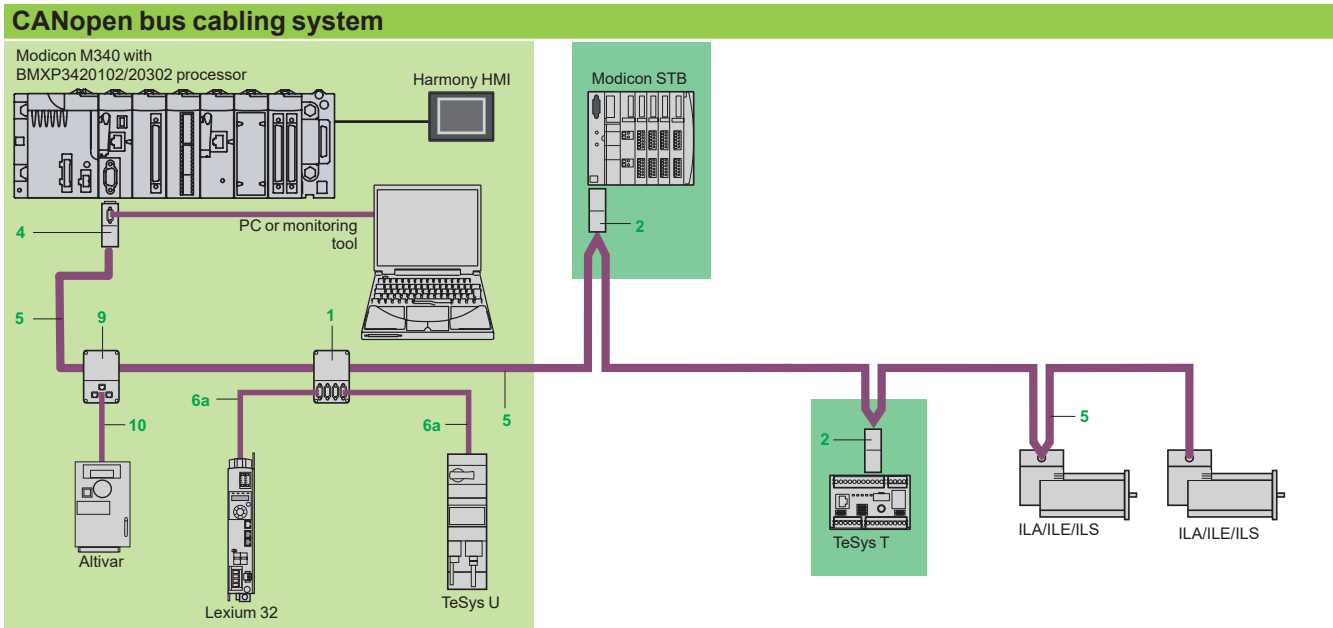

3

Note: For key and references 1, 2, ..., 17, see pages 3/16 to 3/17.

Different types of cable are available, making it possible to create any type of application, including for severe environments (1).

Several connectors are available to meet any requirement: straight or 90° angled connectors, or angled connectors with the option of connecting a PC or diagnostic pocket PC.

Power can be supplied to devices by means of cables, cordsets and tap junctions: one AWG24 pair for the CAN signals, one AWG22 pair for the power supply and the ground.

In addition to the IP20 cabling offer, there is also an IP67 cabling offer.

(1) Standard environment:

- Without any particular environmental constraints
- Operating temperature between + 5°C/41°F and + 60°C/140°F
- Fixed installation

Severe environment:

- Resistance to hydrocarbons, industrial oils, detergents, solder splashes
- Relative humidity up to 100%
- Saline atmosphere
- Significant temperature variations
- Operating temperature between - 10°C/14°F and + 70°C/158°F
- Mobile installation

Modicon M340 automation platform

CANopen machine and installation bus

Cabling system



TSXCANTDM4



VW3CANTAP2



TSXCANKCDF90T



TSXCANKCDF180T



TSXCANKCDF90TP



VW3CANA71

Standard tap junctions and connectors

Designation	Description	No. (1)	Reference	Weight kg/ lb
IP20 CANopen tap junction	4 SUB-D ports. Screw terminal block for connecting the trunk cables Line termination	1	TSXCANTDM4	0.196/ 0.432
IP20 connectors CANopen female 9-way SUB-D. Switch for line termination	90° angled	2	TSXCANKCDF90T	0.046/ 0.101
	Straight (2)	–	TSXCANKCDF180T	0.049/ 0.108
	Right angle with 9-way SUB-D for connecting a PC or diagnostic tool	4	TSXCANKCDF90TP	0.051/ 0.112
IP67 M12 connectors	Male	–	XZCC12MDB50R	0.020/ 0.044
	Female	–	XZCC12FDB50R	0.020/ 0.044
IP20 CANopen tap junctions for Altivar and Lexium 32	2 RJ45 ports	9	VW3CANTAP2	–

IP20 standard cables and preformed cordsets

Designation	Description	No. (1)	Length m/ ft	Unit reference	Weight kg/ lb	
CANopen cables (AWG 24)	Standard, CE marking: low smoke emission. Zero halogen. Flame-retardant (IEC 60332-1)	5	50/	TSXCANCA50	4.930/	
			164.04		10.869	
			100/	TSXCANCA100	8.800/	
			328.08		19.401	
			300/	TSXCANCA300	24.560/	
			984.25		54.145	
	Standard, UL certification, CE marking: flame-retardant (IEC 60332-2)	5	50/	TSXCANCB50	3.580/	
			164.04		7.893	
			100/	TSXCANCB100	7.840/	
			328.08		17.284	
			300/	TSXCANCB300	21.870/	
			984.25		48.215	
	For harsh environments (3) or mobile installations, CE marking: low smoke emission. Zero halogen. Flame-retardant (IEC 60332-1). Oil-resistant	5	50/	TSXCANCD50	3.510/	
			164.04		7.738	
			100/	TSXCANCD100	7.770/	
			328.08		17.130	
			300/	TSXCANCD300	21.700/	
			984.25		47.840	
CANopen preformed cordsets One 9-way female SUB-D connector at each end (AWG 24)	Standard, CE marking: low smoke emission. Zero halogen. Flame-retardant (IEC 60332-1)	6a	1/	TSXCANCADD1	0.143/	
			3.28		0.315	
			3/	TSXCANCADD3	0.295/	
				9.84		0.650
	Standard, UL certification, CE marking: flame-retardant (IEC 60332-2)	6a	1/	TSXCANCBDD1	0.131/	
			3.28		0.289	
3/			TSXCANCBDD3	0.268/		
			9.84		0.591	
CANopen preformed cordsets One 9-way SUB-D connector, One RJ45 connector (AWG 24)		6b	0.5/	TCSCCN4F3M05T	–	
			1.64			
			1/	TCSCCN4F3M1T	–	
			3.28			
				VW3M3805R010 (2)	–	
			3/	TCSCCN4F3M3T	–	
			9.84			

IP20 connection accessories

Designation	Description	No. (1)	Length m/ft	Reference	Weight kg/lb
CANopen connector for Altivar 71 drive (3)	9-way female SUB-D. Switch for line termination. Cables exit at 180°	–	–	VW3CANKCDF180T	–
Adaptor for Altivar 71 drive	SUB-D to RJ45 CANopen adaptor	–	–	VW3CANA71	–
Preformed CANopen cordsets for Altivar drives	One RJ45 connector at each end	10	0.3/	VW3CANCARR03	–
			0.98		
			1/	VW3CANCARR1	–
			3.28		
Y-connector	CANopen/Modbus	–	–	TCSCTN011M11F	–

(1) For key to numbers, see [page 3/15](#).

(2) For connection to Controller Inside programmable card, the [VW3CANKCDF180T](#) connector can also be used.

(3) For [ATV71H●●●M3](#), [ATV71HD11M3X](#), [HD15M3X](#), [ATV71H075N4](#) ... [HD18N4](#) drives, this connector can be replaced by the [TSXCANKCDF180T](#) connector.

Modicon M340 automation platform

CANopen machine and installation bus Cabling system

IP67 standard preformed cordsets

Designation	Description	No. (1)	Length m/ ft	Unit reference	Weight kg/ lb
CANopen preformed cordsets	Preformed cordsets of two 5-way M12 A-coded angled connectors (one male connector and one female connector)	12	0.3/ 0.98	TCSCCN2M2F03	0.09/ 0.198
			1/ 3.28	TCSCCN2M2F1	0.127/ 0.279
			1/ 3.28	TCSCCN2M2F1	0.127/ 0.279
			2/ 6.56	TCSCCN2M2F2	0.179/ 0.394
			5/ 16.40	TCSCCN2M2F5	0.337/ 0.742
			5/ 16.40	TCSCCN2M2F5	0.337/ 0.742

IP67 connection accessories

For Modicon FTB monobloc splitter boxes

Designation	Composition	No. (1)	Length m/ ft	Reference	Weight kg/ lb
IP67 line terminator	Equipped with one M12 connector (for end of bus)	13	–	TM7ACTLA	0.010/ 0.022

Separate parts

Designation	Composition		Sold in lots of	Reference	Weight kg/ lb
Connectors	Straight, M12 type, 5 screw terminals	Male	–	XZCC12MDM50B	0.020/ 0.044
		Female	–	XZCC12FDM50B	0.020/ 0.044
	Angled, M12 type, 5 screw terminals	Male	–	XZCC12MCM50B	0.020/ 0.044
		Female	–	XZCC12FCM50B	0.020/ 0.044
Y-connectors	Connection of two M8 connectors to M12 connector on splitter box	–	–	FTXCY1208	0.020/ 0.044
	Connection of two M12 connectors to M12 connector on splitter box	–	–	FTXCY1212	0.030/ 0.066



XZCC12DM50B



XZCC12CM50B



FTXCY1208

(1) For key to numbers, see [page 3/15](#).



Presentation

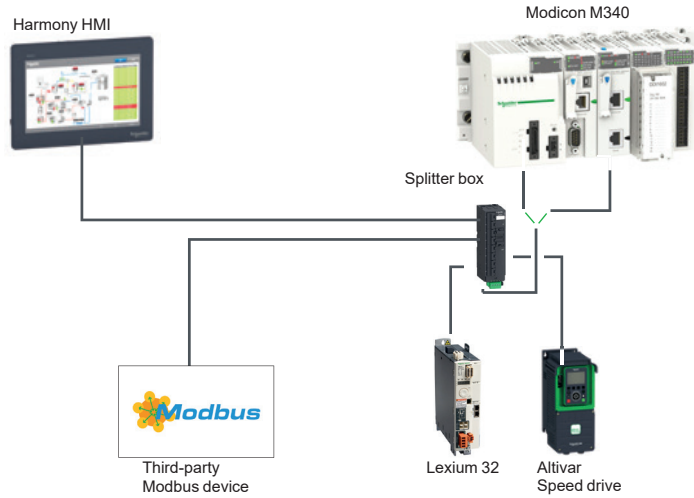

The Modbus serial link is used for master/slave architectures (it is necessary, however, to check that the Modbus services used by the application have been implemented on all relevant devices).

The bus consists of a master station and slave stations. Only the master station can initiate the exchange (direct communication between slave stations is not possible). Two exchange mechanisms are available:

- Question/response, where requests from the master are addressed to a given slave. The master then waits for the response from the slave which has been interrogated.
- Broadcasting, where the master broadcasts a message to all slave stations on the bus. The latter execute the order without transmitting a reply.

The Modicon M340 platform offers serial link connection options for Modbus or Character mode:

- Via the serial link integrated in the following processors:
 - Standard processor **BMXP341000**
 - Performance processors **BMXP342000/20102/2020/20102CL**

The number of serial link modules is limited by the maximum number of application-specific channels permitted per station, depending on the type of processor:

- Standard processor **BMXP341000**: maximum of 20 application-specific channels (1).
- Performance processors **BMXP342000**: maximum of 36 application-specific channels (1).

Description

Processors with integrated serial link

BMXP341000/2000/20102/2020/20102CL processors integrate a serial link which can be used with either the Modbus RTU/ASCII master/slave protocol or with the Character mode protocol.

These processors have the following elements on the front panel, relating to the serial port:

- 1 A display block including at least the following LEDs:
 - SER COM LED (yellow): Activity on the serial link (lit) or fault on a device present on the serial link (flashing).
- 2 An RJ45 connector for Modbus serial link or Character mode link (non-isolated RS 232C/RS 485) with its black indicator (2).

Note: For more information about the processors, see [page 3/18](#)

(1) Application-specific channels: **BMXEHC0200** counter modules (2 channels), **BMXEHC0800** (8 channels), **BMXMSP0200** motion control modules (2 channels) and **BMXNOR0200H** RTU communication module (1 channel).

(2) For isolated serial links, the **TWDXCAISO** isolation box must be used.

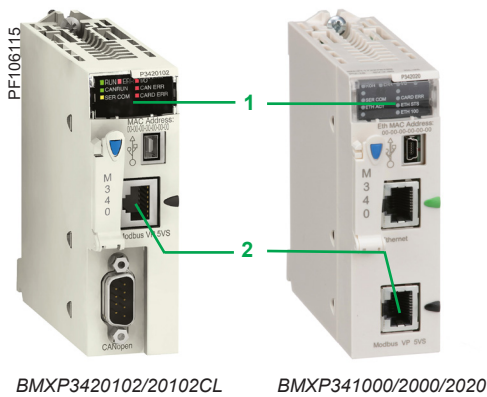

Complementary characteristics

The following characteristics complement those indicated in the selection guide on [page 3/20](#).

Serial link integrated in the processors

- Physical interface:
 - In Modbus: RS 232 4-wire or RS 485 2-wire, non-isolated (1)
 - In Character mode: RS 232 4-wire or RS 485 2-wire
- Frame:
 - In Modbus: RTU/ASCII half duplex
 - In Character mode: full duplex in RS 232, half duplex in RS 485
- Maximum length of a tap link in RS 485 2-wire:
 - 15 m/49.21 ft in a non-isolated serial link
 - 40 m/131.23 ft in an isolated serial link (1)

References

I/O capacity	Memory capacity	Integrated communication ports	Reference	Weight kg/lb
BMXP3410 Standard processor with integrated serial link, 2 racks				
512 discrete I/O 128 analog I/O 20 application-specific channels	2048 KB integrated	Modbus serial link	BMXP341000	0.200/ 0.441
BMXP3420 Performance processors with integrated serial link, 4 racks				
1024 discrete I/O 256 analog I/O 36 application-specific channels	4096 KB integrated	Modbus serial link	BMXP342000	0.200/ 0.441
		Modbus serial link CANopen bus	BMXP3420102 BMXP3420102CL (2)	0.210/ 0.463 0.210/ 0.463
		Modbus serial link Ethernet Modbus/TCP	BMXP342020	0.205/ 0.452

(1) For isolated serial links, the **TWDXCAISO** isolation box must be used.

(2) Memory card must be ordered separately for the **BMXP3420102CL** processor (see [page 2/7](#)).





BMXP341000/2000





BMXP342020

Modicon M340 automation platform

Communication, integrated ports and modules

Applications		Ethernet communication	
Type of device		Processors with integrated Modbus/TCP port	Ethernet modules
			
Network protocols		Ethernet Modbus/TCP	
Structure	Physical interface	10BASE-T/100BASE-TX	
	Type of connector	RJ45	
	Access method	CSMA-CD	
	Data rate	10/100 Mbps	
Medium		Double twisted pair copper cable, category CAT 5E Optical fibre via ConneXium cabling system	
Configuration	Maximum number of devices	-	
	Max.	100 m/328.08 ft (copper cable), 4000 m/13,123.32 ft (multi-mode optical fibre), 32,500 m/106,627 ft (single-mode optical fibre)	
	Number of modules of the same type per station	1	2 Ethernet or RTU modules per station with any BMXP34 processor
Standard services		Modbus/TCP messaging	
Transparent Ready conformity class		B10	B30 C30
Embedded Web server services	Standard services	Rack Viewer PLC diagnostics, Data Editor access to PLC data and variables	
	Configurable services	-	
			Alarm Viewer and Graphic Data Editor Hosting and display of user Web pages (14 MB)
Transparent Ready communication services	I/O Scanning service	-	Yes
	Global Data service	-	Yes
	NTP time synchronization	-	Yes (module version ≥ 2.0)
	FDR service	Yes (client)	Yes (client/server)
	SMTP e-mail notification service	Yes, via EF function block	-
	SOAP/XML Web service	-	Server
	SNMP network management service	Yes	Yes
	RSTP redundancy service	-	-
	QoS (Quality of Service) service	-	-
RTU communication services	Master or Slave configuration	-	-
	Time and date stamped data exchange	-	-
	RTU time synchronization	-	-
	Management and buffering of time and date stamped events	-	-
	Automatic transfer of time and date stamped events to the Master/SCADA	-	-
Data Logging service		-	-
Compatibility with processor		-	Standard and Performance (see page 2/2)
Processor or module references depending on other type of integrated port	No other integrated port		BMXNOE0100 BMXNOE0110
	Serial link	BMXP342020	
	Ethernet Modbus/TCP		
	CANopen	BMXP3420302/ BMXP3420302CL	
Page		3/22	3/23

Ethernet communication		RTU communication	
Ethernet modules		RTU module	
			
EtherNet/IP and Modbus/TCP		Modbus/TCP, IEC 60870-5-104, DNP3 (subset level 3)	Serial link, External modem link, IEC 60870-5-101, DNP3 (subset level 3)
10BASE-T/100BASE-TX		10BASE-T/100BASE-TX (Modbus/TCP), PPPoE (Point-to-Point Protocol over Ethernet) for ADSL external modem link	
Four RJ45 connectors (2 connectors for a ring topology) CSMA-CD		One RJ45 connector	
10/100 Mbps		10/100 Mbps (Modbus/TCP)	
Double twisted pair copper cable, category CAT 5E, optical fibre via ConneXium cabling system		Double shielded twisted pair copper cable, Crossover serial cable (Serial link), Direct serial cable (External modem link)	
128 (EtherNet/IP or Modbus/TCP)		128 (Modbus/TCP), 64 slaves/servers (IEC 104/DNP3)	
100 m/328.08 ft (copper cable), 4000 m/13,123.32 ft (multi-mode optical fibre), 32,500 m/106,627 ft (single-mode optical fibre)		1000 m/3280.83 ft (Serial link with insulating case)	
2 Ethernet or RTU modules per station with any BMXP34 processor		Depending on application-specific channels (20/36 application-specific channels with BMXP341000/P342●●●●)	
EtherNet/IP and Modbus/TCP messaging		Modbus/TCP messaging	
B30		C30	
Rack Viewer PLC diagnostics, Data Editor access to PLC data and variables		-	
-		-	
-		Hosting and display of user Web pages	
-		-	
Yes		-	
-		-	
-		Yes	
Yes (client/server)		Yes (client)	
-		Yes	
-		Server	
Yes		Yes (agent)	
Yes		-	
Yes		-	
-		Yes, IEC101/104 and DNP3	
-		Interrogation via polling and exchanges on change of status (RBE), unsolicited messaging	
-		Yes, IEC101/104 and DNP3	
-		Yes, IEC101/104 and DNP3	
-		Yes, IEC101/104 and DNP3	
-		Buffer holding 10,000 events (per connected client, 4 clients max.)	
-		Yes, on SD 128 MB memory card, in CSV files, access via FTP or sent by e-mail	
Standard and Performance (see page 2/2)			
BMXNOC0401			
	BMXNOR0200H		
		BMXNOR0200H	
3/25	For further information, please consult our "Modicon X80 I/O platform" catalog available on our website www.se.com .		

Modicon M340 automation platform

Communication, integrated ports and modules

Applications
Type of device

CANopen communication
Processors with integrated CANopen port



Network protocols

Structure	Physical interface
	Type of connector
	Access method
	Data rate

Medium

Configuration	Maximum number of devices
	Max. length
	Number of links of the same type per station

Standard services

Conformity class

SMTP service notification by e-mail

Compatibility with processor

Type of processor or module depending on other integrated port	None
	Serial link
	Ethernet Modbus/TCP
	CANopen

CANopen

ISO 11898 (9-way SUB-D connector)	
9-way SUB-D	
CSMA/CA (multiple access)	
20 Kbps...1 Mbps depending on distance	
Double shielded twisted pair copper cable	
63 depending on the devices connected	
20 m/65.62 ft (1 Mbps)...2500 m/8202.08 ft (20 Kbps)	
1	
PDO implicit exchange (application data) SDO explicit exchange (service data)	
Class M20	
–	Yes, via EF function block Unity Pro ≥ 4.0
–	

BMXP3420102/ BMXP3420102CL	
	BMXP3420302/BMXP3420302CL

Serial link communication
Processors with integrated serial link



Modbus and Character mode

Non-isolated RS 232, 4-wire Non-isolated RS 485, 2-wire
RJ45
Master/slave with Modbus link, Full duplex (RS 232)/Half duplex (RS 485) in Character mode
0.3...38.4 Kbps
Double shielded twisted pair copper cable
32 per segment, 247 max.
15 m/49.21 ft (non-isolated), 1000 m/3280.83 ft with insulating case
1
Read/write bits and words, diagnostics in Modbus mode Send and receive character string in Character mode
–
–
–

BMXP341000/2000
BMXP342020 BMXP3420102/BMXP3420102CL

Modicon M340 automation platform

Communication modules

M340 Processors with integrated Ethernet Modbus/TCP link

Presentation

BMXP342020, **BMXP3420302** and **BMXP3420302CL** standard format Modicon M340 processors with integrated Ethernet port occupy a single slot marked "00" in the rack on the Modicon M340 platform.

Description

The front panel of **BMXP342020/20302/20302CL** Modicon M340 processors features:

- 1 A safety screw for locking the module in a slot in the rack.
- 2 A display block with 8 LEDs, including 3 relating to the Ethernet port:
 - ETH ACT LED (green): Activity on the Ethernet network
 - ETH STS LED (green): Ethernet network status

Depending on processor version:

- Version 1: ETH 100 LED (green): data rate on the Ethernet network (10 or 100 Mbps)
- Version 2 and later: ETH LNK LED (green): Ethernet link status

- 3 A mini B USB connector for a programming terminal (or Harmony HMI terminal).
- 4 A slot equipped with its Flash memory card for saving the application and activating the standard Web server (Transparent Ready class B10) (1).
- 5 An RJ45 connector for the connection to the Ethernet network.

Depending on model:

- 6 **BMXP342020** processor: An RJ45 connector for the Modbus serial link or Character mode link (RS 232C/RS 485, 2-wire, non-isolated)
- 7 **BMXP3420302/20302CL** processor: A 9-way SUB-D connector for the master CANopen machine and installation bus.

On the rear panel: 2 rotary switches for selecting the IP address using one of 3 assignment methods:

- Address set by the position of the two switches
- Address set by the application parameters
- Address set by the Ethernet network BOOTP server

References

I/O capacity	Memory capacity	Integrated communication ports	Reference	Weight kg/lb
BMXP3420 Performance processors with integrated serial link, 4 racks				
1024 discrete I/O 256 analog I/O 36 application-specific channels	4096 KB integrated	Modbus serial link Ethernet Modbus/TCP	BMXP342020	0.205/ 0.452
		CANopen bus Ethernet Modbus/TCP	BMXP3420302 BMXP3420302CL (1)	0.215/ 0.474 0.215/ 0.474

(1) Memory card must be ordered separately for the **BMXP3420102CL** processor (see page 2/7).

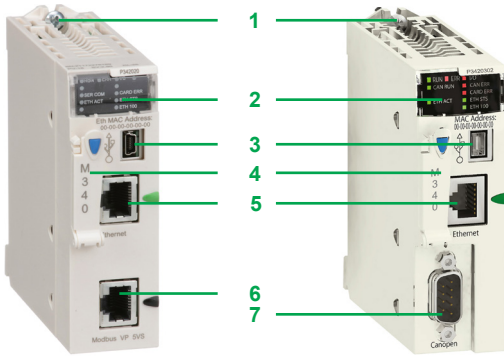

3



BMXP342020



BMXP3420302
BMXP3420302CL

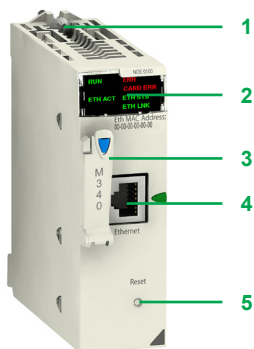

BMXNOE0100

Presentation

BMXNOE0100 and **BMXNOE0110** standard format modules occupy a single slot in the rack on the Modicon M340 platform equipped with a Standard or Performance processor.

Description

The front panel of **BMXNOE0100** and **BMXNOE0110** modules features:

- 1 A safety screw for locking the module in a slot in the rack.
- 2 A display block with 6 LEDs, including 3 relating to the Ethernet port:
 - ETH ACT LED (green): Activity on the Ethernet network
 - ETH STS LED (green): Ethernet network status

Depending on processor version:

- Version 1: ETH 100 LED (green): data rate on the Ethernet network (10 or 100 Mbps)
- Version 2 and later: ETH LNK LED (green): Ethernet link status

- 3 A slot equipped with its Flash memory card for saving the application and activating the Web server (Transparent Ready class B30 or C30 depending on the model).
- 4 An RJ45 connector for connection to the Ethernet network.
- 5 A pencil-point RESET pushbutton for a cold restart of the module.

On the rear panel: 2 rotary switches for assigning the IP address in one of three ways:

- Address set by the position of the two switches
- Address set by the application parameters
- Address set by the Ethernet network BOOTP server

References

Description	Data rate	Transparent Ready Class	Reference	Weight kg/ lb
Modbus/TCP Ethernet module	10/100 Mbps	B30	BMXNOE0100	0.200/ 0.441
		C30	BMXNOE0110 (1)	0.200/ 0.441

Spare parts

Description	Size	Supplied as standard with	Reference	Weight kg/ lb
Flash memory card	8 MB	BMXNOE0100	BMXRWSB000M	0.002/ 0.004
	32 MB	BMXNOE0110	BMXRWSFC032M	0.002/ 0.004

(1) The Web Designer software is supplied on CD-ROM with the **BMXNOE0110** module. This software is used for the configuration and administration of the Web server embedded in the module, see [page 3/10](#).

Modicon M340 automation platform

Communication modules

M340 Ethernet Modbus/TCP network modules

3

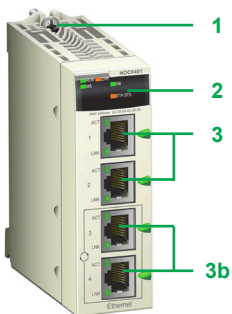

Presentation

The **BMXNOC0401** network module acts as an interface between the M340 PLC and other Ethernet network devices via the Modbus/TCP and EtherNet/IP communication protocols.

The standard format **BMXNOC0401** network module occupies a single slot in the rack of the Modicon M340 platform.

This must be equipped with a Standard **BMXP341000** or Performance **BMXP342●●●●** processor.

Functions

The **BMXNOC0401** module offers the following functions:

- Modbus/TCP and EtherNet/IP protocols operating simultaneously.
- Ring topologies on 2 Ethernet ports using RSTP (*Rapid Spanning Tree Protocol*).
- Priority of Ethernet packets using QoS (*Quality of Service*) service.
- Automatic module configuration recovery using FDR (*Faulty Device Replacement*) service.
- Support for SCADA functions via the OPC *protocol*.
- Embedded Web server for application monitoring and module diagnostics.
- Sharing data between PLCs.
- Network management using SNMP (*Simple Network Management Protocol*).

Description

The front panel of the **BMXNOC0401** module features:

- 1 A safety screw for locking the module in a slot in the rack.
- 2 A display block with 5 LEDs:
 - RUN LED (green): Operating status
 - ERR LED (red): Error detected
 - MS LED (green/red): Module status
 - NS LED (green/red): Network connection status
 - ETH STS LED (amber): Ethernet link status
- 3 Four RJ45 connectors for connection to the Ethernet network. The two bottom connectors **3b** support ring topologies (RSTP protocol).

Each RJ45 connector has two associated LEDs:

- LNK LED (yellow): Ethernet link established
- ACT LED (green): Transmission/reception activity

On the rear panel, 2 rotary switches for selecting the IP address module using one of 4 assignment methods:

- IP address defined by the Ethernet network BootP server
- IP address configured by the application parameters
- Default IP address
- IP address defined by the position of the 2 rotary switches

Modicon M340 automation platform

Communication modules
M340 Ethernet Modbus/TCP network modules



BMXNOC0401

References				
Description	Data rate	Transparent Ready Class	Reference	Weight kg/lb
EtherNet/IP and Modbus/TCP Ethernet module	10/100 Mbps	B30	BMXNOC0401	0.345/ 0.761

Modicon M340 automation platform

Communication modules M580/M340 RTU module



Presentation

RTU protocols and Telemetry systems provide a robust means of communication suitable for the process values, maintenance, and remote monitoring needs of infrastructures disseminated over a vast geographical area that may be difficult to access.

RTU systems are designed to meet the needs of the water industry, the oil and gas sector, and other infrastructures, where remote monitoring and telecontrol are essential to the effective management of sites and substations spread over a wide geographical area.

An RTU system consists of the following elements:

- A Telemetry Supervisor (SCADA) in a central control room
- A network infrastructure and a variety of suitable communication methods (LAN, WAN, modems, etc.)
- A large number of RTU substations geographically distributed throughout the field

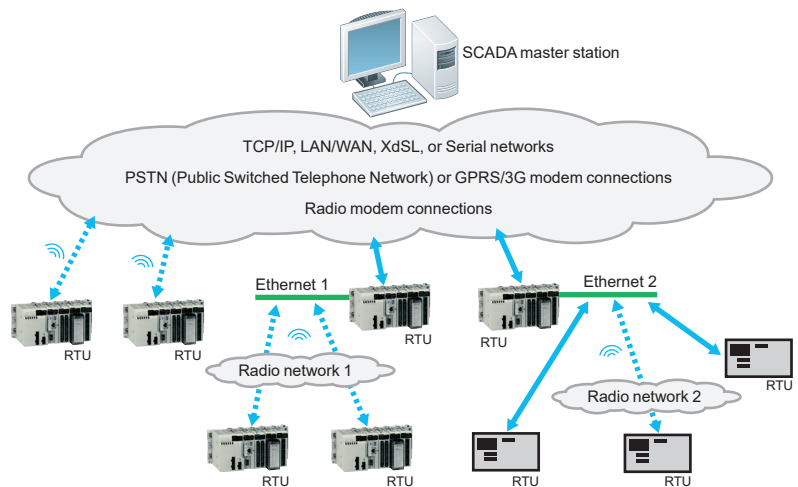

Example of an RTU system architecture

RTU communication protocols

Currently, people working in the industrial Telemetry sectors use standard protocols for communication between control centers (SCADA) and RTU stations.

The most commonly used protocols are as follows:

- IEC 60870-5: IEC (International Electrotechnical Commission), in particular IEC 60870-5-101/104 (commonly known as IEC 101 or 104)
- DNP3: Distributed Network Protocol version 3

DNP3 is the predominant protocol in North America, Australia, and South Africa whereas, in certain European countries, the IEC protocol is required by law. IEC is also commonly used in the Middle East.

The geographical distribution of these protocols is as follows:

- DNP3: North America, Australia, New Zealand, UK, Asia, South America, etc.
- IEC 60870-5: Europe, Middle East, Asia, South America, etc.

These protocols offer similar functions.

They are both particularly suited to “transient communications” (modem, radio) and data exchanges with limited bandwidth for the following reasons:

- They transfer data in a very robust manner between the SCADA system and the RTU devices
- They are essentially “event-triggered” protocols (exchanges on changes of state, exchanges of time- and date-stamped events).

They offer the following transmission modes:

- Interrogation via polling
- Data exchanges on changes of state (RBE: report by exception)
- Unsolicited messaging (a slave station can start an exchange of data with the master station)

Both protocols offer native data management and time- and date-stamped events:

- Time synchronization between the master station and auxiliary stations via protocol functions
- Time- and date-stamping of data and events
- Automatic transfer of time- and date-stamped events between the RTU stations and SCADA (control room)

Modicon M340 automation platform

Communication modules M580/M340 RTU module

Main functions

The main RTU system functions are as follows:

- Remote communications:
 - Between remote RTU sites (coordination, synchronization)
 - With the SCADA host system, controlling the central operator station (monitoring, alarm reports) and centralized databases (archiving of alarms or events)
 - With the on-call staff (alarm indication)
 - With the technical station (diagnostics, maintenance)
- Data acquisition, processing, and memorization:
 - Process data sampling using standard or dedicated sensors, validation
 - Exchange of data with other devices within the station, including controllers and operator consoles
 - Use of discrete or analog I/O, serial links, fieldbuses, and LANs
 - Event detection, time- and date-stamping, prioritization, and logging as required by the application
- Other functions:
 - IEC 1131-3 programmable control: forcing, access control, load sharing, servo control
 - Data logging
 - Alarm and report notification by e-mail/SMS
 - Web HMI: displaying the process, alarm handling, trend analysis, telecontrol
 - High reliability with hardened and ATEX range

The **BMXNOR0200H** RTU communication module features the following characteristics:

Features	BMXNOR0200H
Platform support	M340, M580
RTU protocol	DNP3, DNP3 NET, IEC60870-5-101, IEC60870-5-104
Ethernet protocol	SNMP, SNTP, Modbus/TCP, SMTP, FTP, HTTP
Firmware upgrade tool	Unity loader
Cybersecurity	Standard
Web diagnostics	Standard diagnostics
Data logging (1)	Yes
Serial port (1)	Yes
IP address assignment	DHCP, BootP, Static IP
SD card availability (1)	Mandatory
Event buffer size	100,000
Maximum input data	7,000 points totally (including input/output)
Maximum output data	7,000 points (including input/output)
Data attribution	Located/Unlocated
Strings exchange in DNP3	No
DNP3 SA key method	No
DNP3 secure statistics	No
TLS on RTU protocols (2)	No

(1) The SD card is only used for the data logging feature.

(2) TLS V1.2 for RTU protocols (DNP3/IEC104)

Modicon M340 automation platform

Communication modules M580/M340 RTU module

Presentation

The **BMXNOR0200H** communication module integrates the RTU (remote terminal unit) functions and protocols in the Modicon M340 automation platform for industrial telemetry applications and other widely distributed infrastructures.

The **BMXNOR0200H** module can be used to connect an RTU M340 PLC directly to a telemetry supervisor or to other RTU stations, via the standard DNP3 protocols (subset level 3) or IEC 60870-5-101/104 with different connection methods: Ethernet TCP/IP, LAN, WAN, serial link, or modem connections (radio, PSTN, GSM, GPRS/3G, ADSL).

The **BMXNOR0200H** module is designed to operate in a harsh environment (conformal coating) and an extended temperature range (-25 to +70 °C/-13 to +158 °F).

Functions

The **BMXNOR0200H** module offers the following functions:

- Upstream RTU communication to the SCADA (server or slave mode)
- Downstream RTU communication to field devices (master mode)
- RTU protocols: Time synchronization, exchanges of time- and date-stamped data via polling (on change of state and unsolicited), management of time- and date-stamped events
- Application data logging with time- and date-stamping in the module Flash memory card
- Event notifications via e-mail or SMS
- Embedded Web server for setting the RTU protocol parameters, diagnostics, and monitoring

- Communications on Ethernet port:
 - 10BASE-T/100BASE-TX physical interface
 - Modbus/TCP protocol (client and server)
 - Integrated RTU protocols for Ethernet communications: DNP3 IP (client or server) and IEC 60870-5-104 (over IP) (client or server)
 - Connection of ADSL external modem on the Ethernet port, via the PPPoE (Point-to-Point Protocol over Ethernet) protocol
 - Advanced Ethernet functions: NTP client, FTP client or server, HTTP server, SOAP/XML server, SNMP agent, SMTP agent

- Communications on serial port:
 - Isolated RS232/RS485 point-to-point serial links
 - Integrated RTU protocols for serial and modem communications: IEC 60870-5-101 (master or slave) and DNP3 serial (master or slave)
 - Connection of external modems (radio, PSTN, GSM, GPRS/3G) via the PPP (Point-to-Point Protocol) protocol

Description

The **BMXNOR0200H** module can be installed in either a standard or "ruggedized" configuration, equipped with a standard **BMXP34●●●●●/BMEP58●●●●●** or "ruggedized" **BMXP34●●●●●H/BMEP58●●●●●H** processor.

The front panel of the **BMXNOR0200H** module features:

- 1 A screw for locking the module in a slot in the rack
- 2 A display block with 8 LEDs, 4 of which relate to the serial and Ethernet communication ports
- 3 A slot for a Flash memory card (SD card), with protective cover
- 4 An RJ45 connector for connection to the Ethernet network
- 5 An RJ45 connector for connection of the serial link or an external modem

On the rear panel, 2 rotary switches for selecting the IP address assignment method for the module.

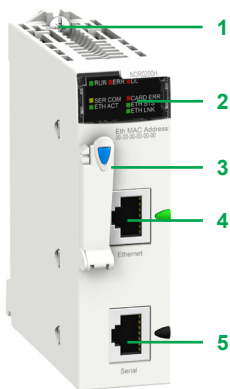

Modicon M340 automation platform

Communication modules
M580/M340 RTU module



BMXNOR0200H

References

Description	Communication port	Protocol	Reference	Weight kg/lb
M580/M340 RTU module (1)	Ethernet 10BASE- 100BASE-TX	<ul style="list-style-type: none"> ■ Modbus/TCP (client or server), Transparent Ready class C30 ■ DNP3 IP (client or server) ■ IEC 60870-5-104 (over IP) (client or server) 	BMXNOR0200H (2)	0.205/ 0.452
		Serial, External modems		<ul style="list-style-type: none"> ■ Isolated RS232/RS485 point-to-point serial links ■ DNP3 serial (master or slave) ■ IEC 60870-5-101 (master or slave)

Spare parts

Description	Usage	Supplied with module	Reference	Weight kg/lb
128 MB Flash memory card supplied as standard with the module	Web pages, storage of data logging files (CSV)	BMXNOR0200H	BMXRWS128MWF	0.002/ 0.004

(1) See module for severe environments characteristics, [page 5/3](#).

(2) The Web Designer software is supplied on CD-ROM with the module. This software can be used to configure and download the embedded website and to configure advanced services: data logging, sending alarm notifications via SMS or e-mail. For further information, please consult our website www.se.com.

- Comparison table of I/O architectures** page 4/2
- **Local I/O architecture** page 4/4
- **Integrated fieldbus architecture** page 4/5
- **Distributed I/O architecture** page 4/6
- **Example of an M340 standard architecture** page 4/7
- **References and requirements** page 4/8

- **EcoStruxure Plant Ethernet Architectures** page 4/10
 - Logical communication architecture page 4/10
 - Physical communication architecture page 4/11

- **Ethernet network infrastructure (Technical information)** page 4/12
 - Presentation page 4/12
 - Network topologies page 4/13
 - Physical characteristics page 4/15
 - Device management page 4/16
 - Redundancy page 4/17

Modicon M340 automation platform

Architectures Standard I/O architectures

Modicon M340 architecture type

Note: These architectures can be combined with each other

Architectures with local racks (main rack and expansion racks)

Hardwired

Compact topology with devices hardwired on local I/O

Local I/O architecture

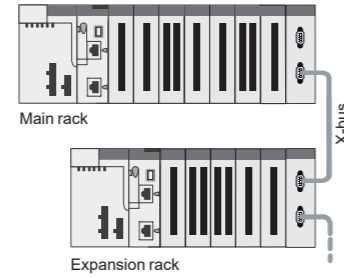

Expanded rack (with X-bus rack expansion module)

Backplane compatibility BMEXBP●●00 Ethernet + X-bus racks

BMXXBP●●00 X-bus racks PV02 (or later)

Compatible CPU types

CPU Ethernet ports SERVICE port

Dual port

Communication AS-Interface and serial link modules

BMXNOR0200H RTU module

Ethernet modules

Expert functions PTO (pulse train output) modules

Other expert modules: counter, SSI encoder, etc.

Time stamping 1 ms max. BMXERT1604T module integrated in the ERT module

Pages

Main local rack with up to 4 local expansion racks on X-bus (Modicon X80 or Modicon Premium racks)

Compatible for main racks (local or distant)

Mandatory for expansion racks (main or distant)
Compatible with any rack provided that no Modicon X80 expert modules (such as weighing) are used in the racks

All processors are compatible

One SERVICE port for HMI, EcoStruxure Control Expert (1), control network, variable speed drive, etc.

Dual ports are not used

Yes

Yes

Yes

Yes

Yes

Yes

4/5

(1) Unity Pro software in earlier versions.

Architecture with local racks (main rack and expansion racks)

Distributed peripherals over fieldbuses

Distributed peripherals and I/O over Ethernet

Compact topology with devices distributed over fieldbuses

Distributed devices and I/O topology over Ethernet

Integrated fieldbus architecture

Distributed I/O architecture

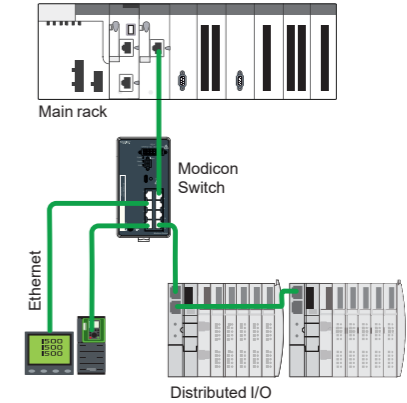
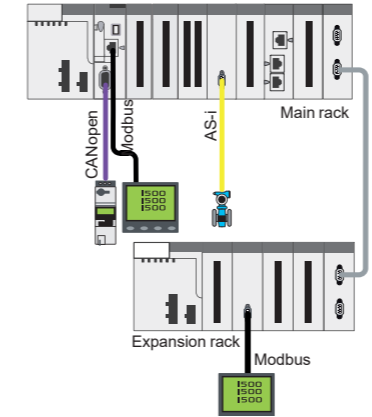

Main local rack with up to 4 local expansion racks on X-bus (Modicon X80 or Modicon Premium racks)

Compatible for main racks (local or distant)

Mandatory for expansion racks (main or distant)
Compatible with any rack provided that no Modicon X80 expert modules (such as weighing) are used in the racks

BMXP341000 and **BMXP3420●●●** processors for CANopen fieldbuses
BMXP3420●02 processors for Modbus fieldbuses

One SERVICE port for HMI, EcoStruxure Control Expert (1), control network, variable speed drive, etc.

Dual ports are used for distributed equipment (DIO scanner)

Yes

Yes

Yes

Yes

Yes

Yes

4/7

Main local rack with up to 4 local expansion racks on X-bus (Modicon X80 or Modicon Premium racks)

Compatible for main racks (local or distant)

Mandatory for expansion racks (main or distant)
Compatible with any rack provided that no Modicon X80 expert modules (such as weighing) are used in the racks

All processors are compatible

One SERVICE port for HMI, EcoStruxure Control Expert (1), control network, variable speed drive, etc.

Dual ports are used for distributed equipment (DIO scanner)

Yes

Yes

Yes

Yes

Yes

Yes

4/7

Modicon M340 automation platform

Architectures

Local I/O architecture

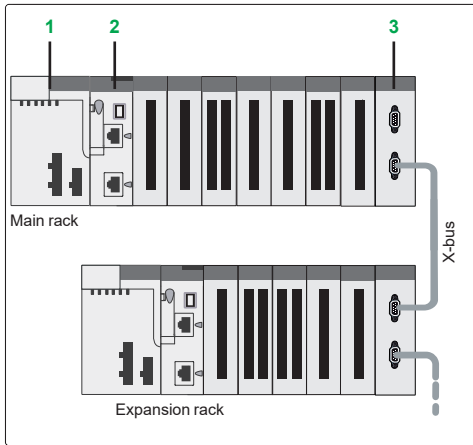

Local I/O architecture: devices on local I/O

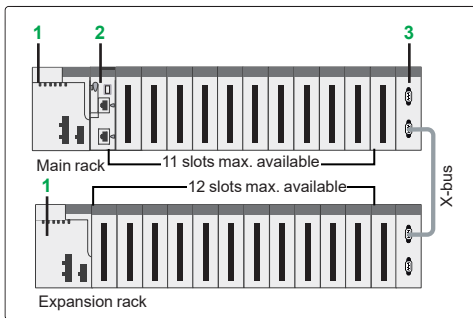

Local I/O architecture



DIA6ED2131203EN



DIA6ED2140903EN

Presentation

Local I/O architecture is used for control systems that reside in the main control cabinet.

The M340 platform provides interrupt services for this type of application.

Up to 47 slots are possible for I/O modules in a configuration comprising a main rack and 4 expansion racks, connected by **BMXXBE●00●** rack expansion modules.

Description

The Modicon M340 automation platform provides local I/O management for control systems that are wired to the main control cabinet.

Local I/O architecture can comprise a maximum of 11 I/O modules in the main rack, in addition to the CPU **2** and the power supply module **1**.

These local I/O can be extended on an expansion rack by using a **BMXXBE●00●** rack expansion module **3**.

Ethernet slots are only available in the main rack because rack expansion cables only support X-bus.

The choice of appropriate rack depends on the required number of modules for the system. Main racks are available in the following formats: 4, 8, and 12 slots.

As well as discrete and analog I/O modules, the following modules are available:

- Application-specific modules:
 - SSI encoder
 - Counter
 - Pulse train output

If necessary, communication and network modules can be installed in the local rack. The majority of communication and network modules need to be in the local rack.

Local I/O architecture configuration rules

When configuring a local I/O architecture system, the following four parameters should be considered:

- Number of slots available in the 4 local racks (main and expansion racks)
- Slots available for optional modules
- Power consumed by the installed modules
- Addressing words available for configuring the modules

Available slots and power consumption

The local I/O architecture can have a maximum of 46 available slots (with four 12-slot racks) for I/O modules, application-specific modules, and communication modules.

These modules are powered from the power supply included in the rack.

For a valid configuration, simply add together the consumption (in mA) of the modules in the rack and check that the total current is less than that provided by the selected power supply.

This power consumption calculation can easily be performed using EcoStruxure Control Expert (1) software.

BMXXEM010 protective covers are also available to occupy unused slots.

Module addressing

With EcoStruxure Control Expert (1), the I/O addressing is unlimited (physical limitation: 47 slots).

(1) Unity Pro software in earlier versions.

Modicon M340 automation platform

Architectures

Integrated fieldbus architecture

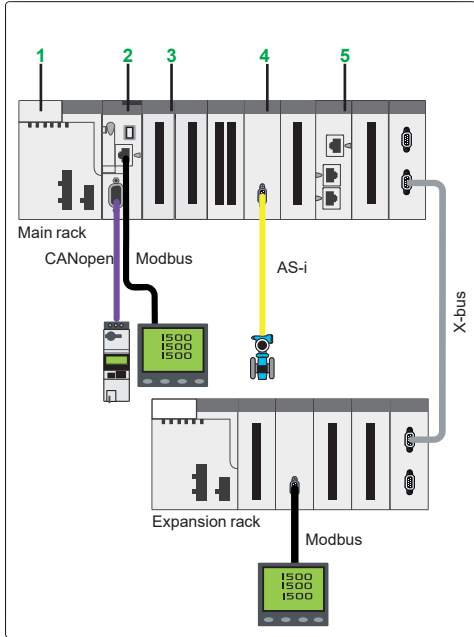

Integrated fieldbus architecture: devices distributed over fieldbuses

Presentation

The integrated fieldbus architecture is based on local I/O architecture with the possibility of adding fieldbuses such as AS-Interface, Modbus SL, PROFIBUS, CANopen.

This kind of architecture is used for control systems that are wired to the main control cabinet.

It consists of a mainly local topology with several peripherals distributed over fieldbuses.

The Modicon M340 automation platform provides interrupt services for this type of application.

Up to 46 slots are possible for I/O and communication modules in a configuration comprising a main rack and 4 expansion racks, connected by **BMXXBE●00●** rack expansion modules.

Description

The Modicon M340 automation platform provides local I/O management for control systems that are wired to the main control cabinet.

The integrated fieldbus architecture can comprise a maximum of 2 I/O and communication modules in the main **BMEXBP●●00** rack, in addition to the CPU **2** and the power supply **1**. These local I/O and communication modules can be extended on expansion racks by using a **BMXXBE●00●** rack expansion module.

The choice of appropriate racks depends on the required number of modules for the system. Main racks are available in the following formats: 4, 8, and 12 slots.

If necessary, communication and network modules can be installed in the main rack. The majority of communication and network modules need to be in the main rack.

As well as discrete and analog I/O modules, the following communication modules are available:

- Serial link **3**
- AS-Interface **4**
- RTU communication module **5**

Some communication modules (Modbus/TCP and EtherNet/IP network module, etc.) require the use of an Ethernet backplane.

Integrated fieldbus architecture configuration rules

When configuring an integrated fieldbus architecture system, the following four parameters should be considered:

- Number of slots available in the 4 local racks
- Slots available for optional modules
- Power consumed by the installed modules
- Addressing words available for configuring the modules

Available slots and power consumption

The integrated fieldbus architecture can have a maximum of 46 available slots (with four 12-slot racks) for I/O modules, application-specific modules, and communication modules.

These modules are powered from the power supply included in the rack.

For a valid configuration, simply add together the consumption (in mA) of the modules in the rack and check that the total current is less than that provided by the selected power supply.

This power consumption calculation can easily be performed using EcoStruxure Control Expert software.

BMXXEM010 protective covers are also available to occupy unused slots.

Module addressing

With EcoStruxure Control Expert (1), the I/O addressing is unlimited (physical limitation: 46 slots).

(1) Unity Pro software in earlier versions.

Modicon M340 automation platform

Architectures

Distributed I/O architecture

Presentation

The distributed I/O architecture consists of I/O and devices distributed over Ethernet (DIO).

The Ethernet DIO devices can be connected to Ethernet ports of the **BMXNOE0110 1** or **BMXNOC0401 2** modules and a Modicon Switch **3**.

The available Ethernet DIO devices are:

- Modicon STB distributed I/O **4**
- Altivar Process variable speed drive **5**
- Energy supervision **6** and HMI

Modbus serial link devices can be integrated in the distributed I/O architecture via the **BMXNOM0200** serial link module.

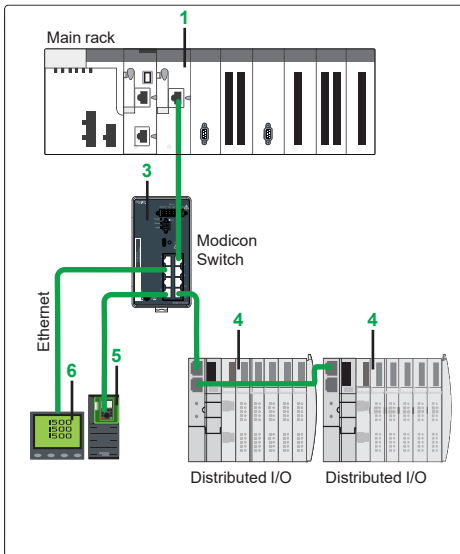

4 Distributed I/O architecture: devices distributed over Ethernet with BMXNOE0110 module and Modicon Switch

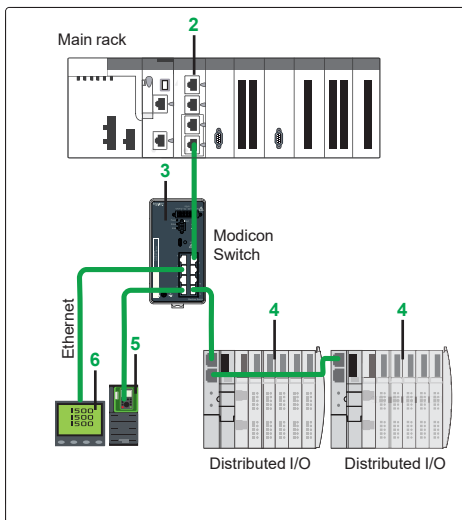

Distributed I/O architecture: devices distributed over Ethernet with BMXNOC0401 module and Modicon Switch

Example of a typical standard architecture

The architecture below illustrates the possibilities of the Modicon M340 offer:

- A choice from 6 **BMXP34●0●0** CPUs
- Companionship with M580 automation platform and/or MC80 PLC
- Modicon range provides a large choice of products to connect Ethernet devices and build a complete networking infrastructure (firewalls, switches, distributed solutions)
- Communication with SCADA via Ethernet
- Communication buses and networks available (Modbus Serial Link, CANopen, PROFIBUS DP, AS-i-interface)
- Long distance optimized by the fiber optic converter installed directly in the Modicon X80 rack
- Simplified integration of devices via a serial link (for example, power meter, variable speed drive, motor starters, protection relays, etc.); FTD/DTM technology makes it possible to configure and debug devices transparently via the Ethernet network, from any supervisor
- Great flexibility due to integration of DIO devices

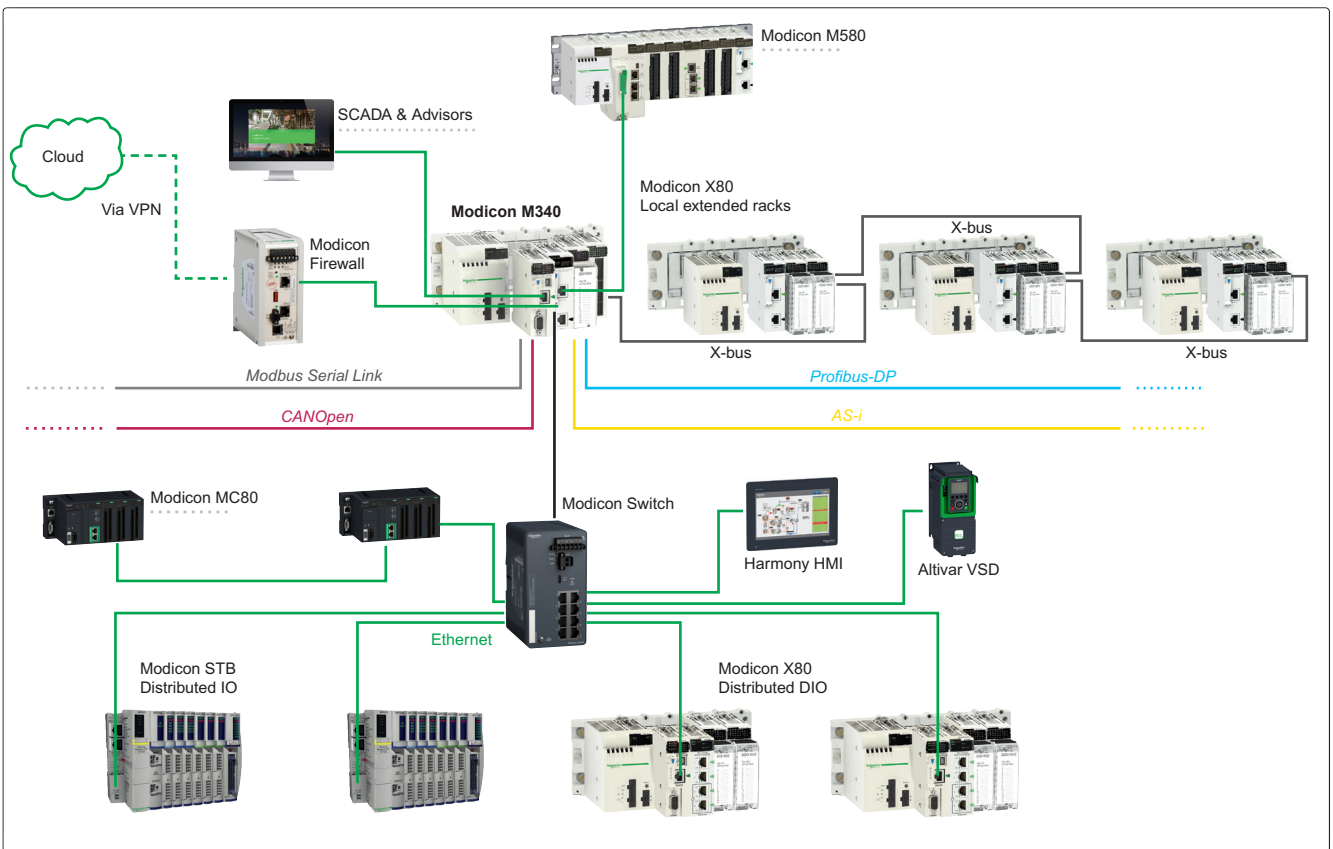

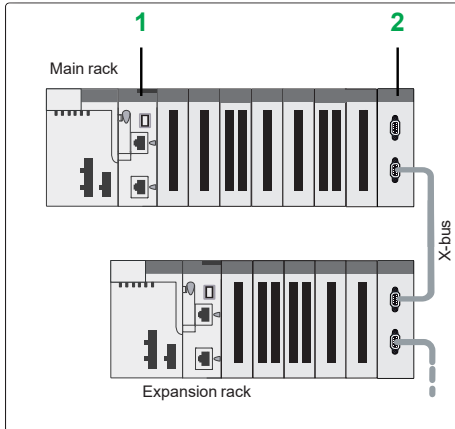

Local I/O architecture

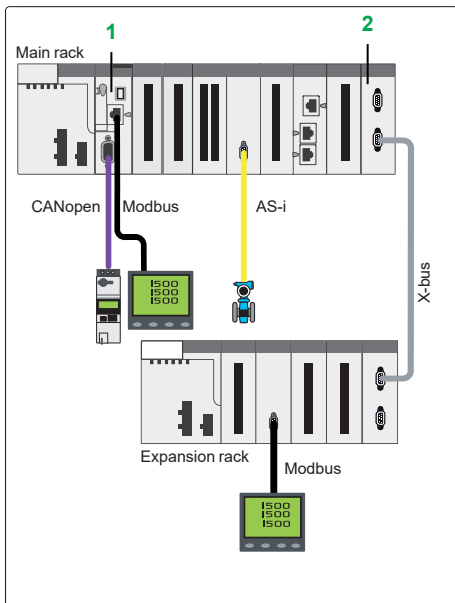

Integrated fieldbus architecture

References

Modicon M340 processors

I/O capacity	Integrated communication ports	Item Reference (2)	Weight kg/lb
512 discrete I/O 128 analog I/O 20 application-specific channels	Modbus serial link	1 BMXP341000	0.200/ 0.441
1,024 discrete I/O 256 analog I/O 36 application-specific channels	Modbus serial link	1 BMXP342000	0.200/ 0.441
	Modbus serial link CANopen bus	1 BMXP3420102	0.210/ 0.463
		1 BMXP3420102CL	0.210/ 0.463
	Modbus serial link Ethernet Modbus/TCP	1 BMXP342020	0.205/ 0.452
	CANopen bus Ethernet Modbus/TCP	1 BMXP3420302	0.215/ 0.474
		1 BMXP3420302CL	0.215/ 0.474

Rack expansion for Modicon X80 drop

Description	Item Reference (2)	Weight kg/lb
Modicon X80 rack expansion module Standard module for mounting in each rack (XBE slot) allowing the interconnection of 2 racks max.	2 BMXXBE1000	0.178/ 0.392
Modicon X80 rack expansion kit Complete kit for 2-rack configuration comprising: - 2 BMXXBE1000 rack expansion modules - 1 BMXXBC008K extension cordset, length 0.8 m/2.63 ft - 1 TSXTLYEX line terminator (pack of 2)	2 BMXXBE2005	0.700/ 1.543

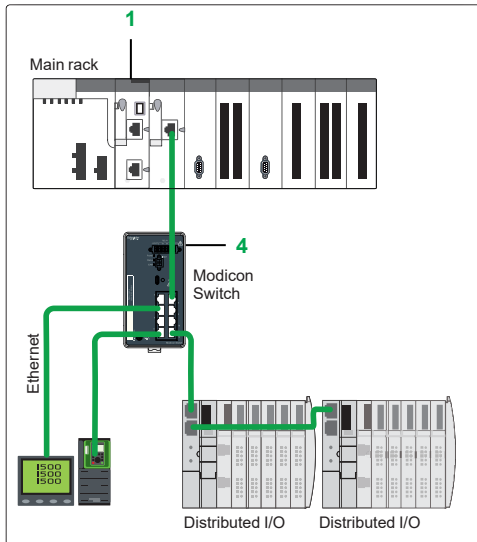

Distributed I/O architecture with BMXNOE0110



[DIA6ED2140903EN](#)

References (continued)

M340 Ethernet communication modules

Description	Item	Reference	Weight kg/lb
EtherNet/IP and Modbus/TCP network module	–	BMXNOC0401	0.200/ 0.441
Ethernet Modbus/TCP module	3	BMXNOE0100	0.200/ 0.441
FactoryCast Ethernet Modbus/TCP module	3	BMXNOE0110	0.200/ 0.441

Modicon M340 automation platform

PlantStruxure Ethernet Architectures
Logical communication architecture

Logical communication architecture

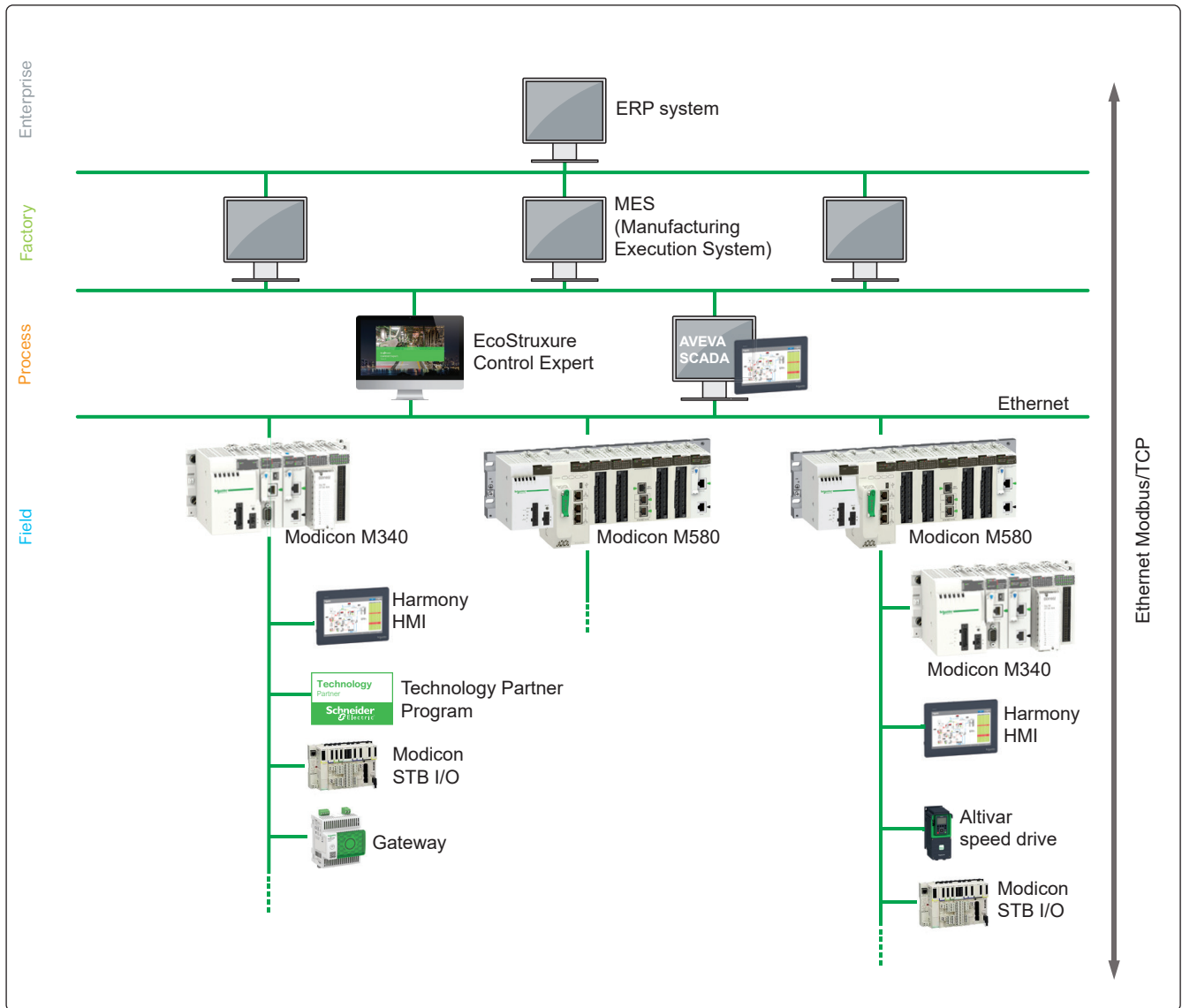

Modicon M340 automation platform

PlantStruxure Ethernet Architectures
Physical communication architecture

Physical communication architecture

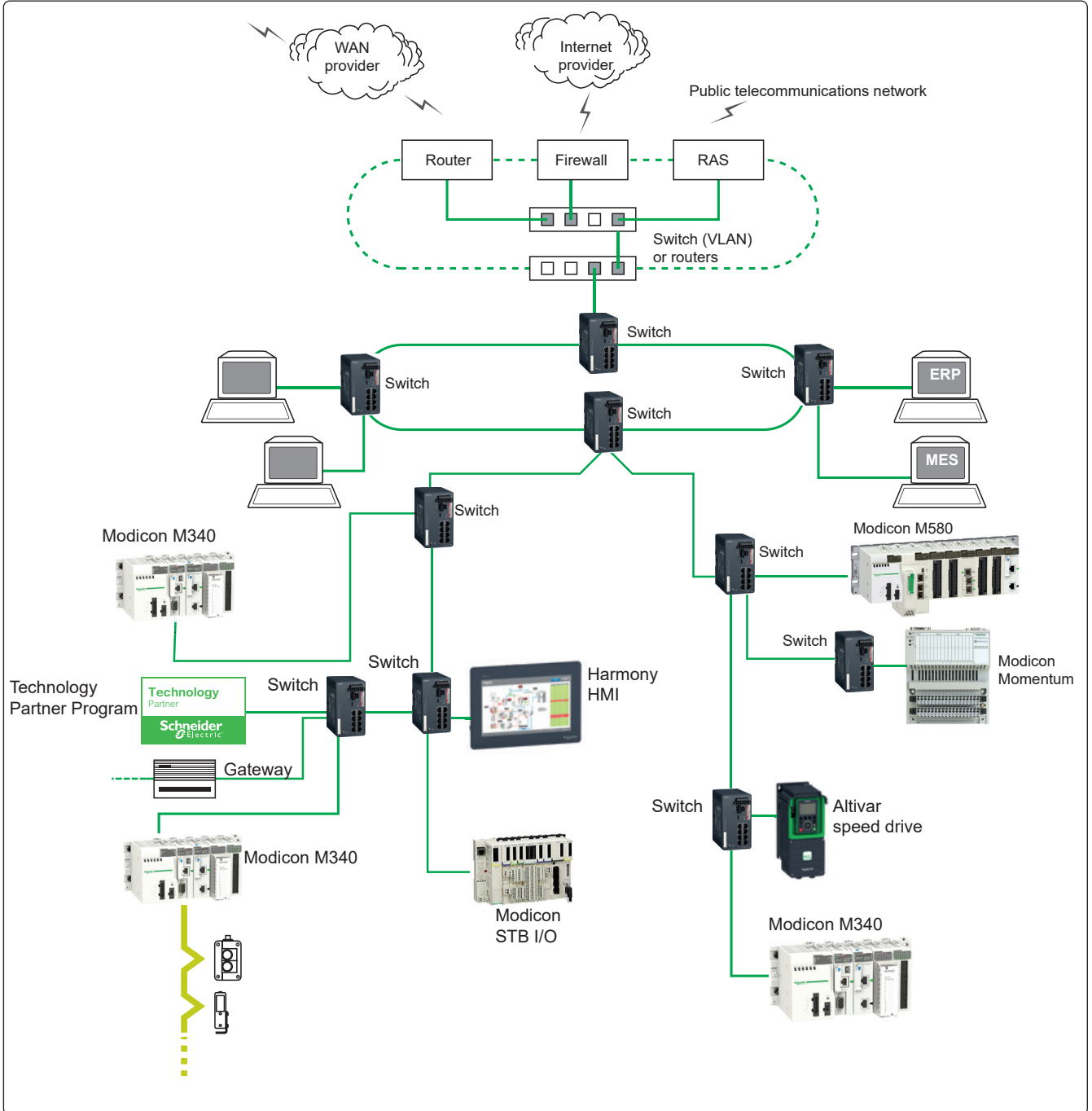

4



DIA6ED2140903EN

Presentation

The Modicon Networking offer comprises a complete family of products and tools required to build the infrastructure of an Industrial Ethernet network.

The following pages provide information on network design and component selection.

For more details, please consult our Modicon Networking catalog.

Office Ethernet versus Industrial Ethernet

There are three main areas of differentiation between Ethernet applications in an office environment and those in an industrial environment:

- Environment
- Layout (not physical layer specification)
- Performance

In contrast to the office environment and even though ISO/IEC is working on it, as yet there are no clearly defined specifications for Ethernet devices intended for industrial applications. The specifications for what is called the Industrial Ethernet are defined by different agencies or entities based on its nature and what the automation market has traditionally used.

The environmental specifications of Industrial Ethernet devices are defined by the traditional agencies that define the environmental specifications for standard industrial devices (UL, CSA, CE, etc.).

IEEE 802.3 defines the physical layer specifications of the Ethernet network (types of connector, distance between devices, number of devices, etc.) while standard 11801 (similar to TIA/EIA 568B and CENELEC EN 50173) provides layout guidelines for installers.

The performance specifications are currently being drawn up by ISO/IEC.

Ethernet 802.3 principles

The Ethernet 802.3 Link Layer is based on a collision detection mechanism (CSMA CD) whereby every node whose information has collided on the network detects the collision and re-sends the information.

The process of re-sending information causes delays in its propagation and could affect the application.

A collision domain is a group of Ethernet end devices interconnected by hubs or repeaters (devices that receive information and send it out to all their other ports, no matter where the destination device is connected). This means that all devices will be affected by collisions.

With full duplex switches (devices that receive information and only send it out through the port to which the destination device is connected), there are no collision domains.

Therefore, for industrial automation applications, it is highly advisable to use full duplex switches to interconnect devices. This will help eliminate collision domains.

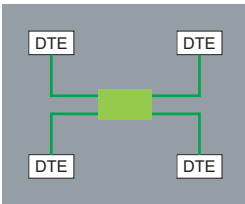

Star topology

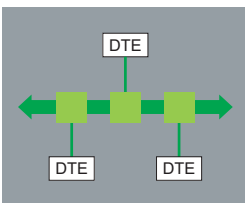

Bus topology

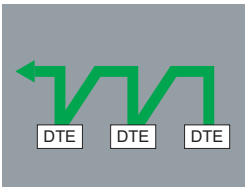

Daisy chain topology

Network topologies

Star topology

In a star topology, all devices and data terminal equipment (DTE) are connected through an intermediate device.

- Ethernet star

In an Ethernet star the intermediate device may be a **switch**. The star is the most commonly used topology in corporate networks and is currently adopted in almost every automation application. As mentioned previously, for industrial Ethernet applications the use of full duplex switches as the central device rather than hubs is highly recommended.

- Deploying star topologies with Modicon Switches

Star topologies can be implemented with any of the switches in the Modicon offer.

Bus topology

The bus is one of the most common topologies in traditional industrial automation networks. A single trunk cable connects all devices on the network usually via passive or active T-connectors, or directly chained (daisy chain). Devices can usually be installed anywhere along the bus.

- Ethernet bus

An Ethernet bus can be deployed by interconnecting **switches** in line and considering every one of them as the connection for a drop device. An unlimited number of switches can be interconnected to achieve this purpose.

- Deploying bus topologies with Modicon Switches

Bus topologies can be implemented with any of the switches in the Modicon offer.

Switches with 1 or 2 fiber optic ports are particularly suitable for this purpose:

- Switches with 2 fiber optic ports can be used to connect in-line devices.
- Switches with 1 fiber optic port can be used to connect end-of-line devices.

Daisy chain topology

Daisy chain - along the bus - is the other most common topology in traditional industrial automation networks. Cable segments interconnect multiple devices, being the devices "part" of the network cable.

- Ethernet daisy chain

Daisy chain is currently not a particularly common Ethernet topology, but it is likely to rise in popularity as more devices become available.

Ethernet daisy chain devices have:

- **2 Ethernet ports** and
- **1 embedded switch**

Schneider Electric is launching Industrial Ethernet devices on the industrial market for connection in daisy chain architectures.

- Deploying daisy chain topologies

No switches are required for daisy chain topologies. All devices have an embedded switch.

Dual port Ethernet at device level is an absolute integral component for daisy chain topologies.

One port on the device connects to one port on each of the two neighboring devices. These neighboring connections make up the daisy chain.

Ethernet switches can be employed in a daisy chain topology when multiple scan chains are in use by the controlling device. It is expected that the Ethernet switch will be located near the controlling device with the different scan chains emanating from the switch.

- Limitations of the daisy chain:

Limitations of the daisy chain topology in terms of operational integrity of the network and performance metrics are as follows:

- Dual port Ethernet devices only support 10 Mbps and/or 100 Mbps operational speeds and must use one or the other.
- The network will operate only as fast as the slowest device that is connected to the network.
- In order to improve network traffic latency, the number of devices in a single scan chain is limited to 32 devices. This means that the time for a round trip of a packet through the daisy chain is likely to be less than 5 milliseconds.

The maximum latency of a packet passing through any device in a scan chain is no more than 10 μ s.

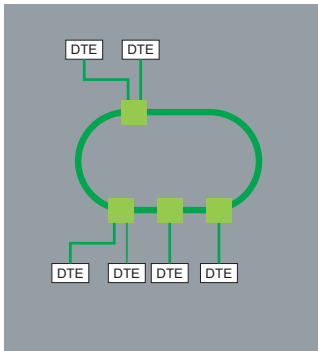

Ethernet ring topology

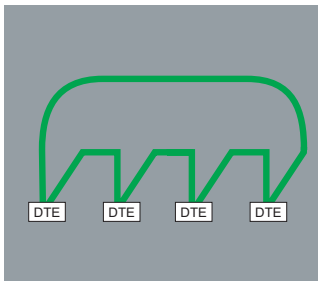

Daisy chain ring topology

Different network topologies (continued)

Ring topology

In a ring topology, all devices or network infrastructure components are connected in a loop. Through this type of topology, network redundancy is achieved.

Ring topologies also help to improve the availability of the network and its communication with devices.

- Ethernet ring

Ethernet rings are usually the backbones of applications in which high availability is required. If ring topology is required, switches that support this feature should be ordered.

- Deploying ring topologies using Modicon Switches

Modicon Networking offer comprises switches that allow the deployment of single and coupled self-healing rings (see [page 4/12](#) for more information).

- Daisy chain loop

A daisy chain loop consists of several daisy chain devices that are placed in a ring topology.

When an Ethernet network forms a loop, all the devices in that loop must use the same protocol (RSTP, MRP, or HIPER-Ring).

Physical characteristics

Distance limits and number of devices per segment

Based on standard 802.3, the distance limits and number of devices in cascade are as follows:

Type	Maximum segment length (1)	Maximum segment length (offered by Modicon switches)	Maximum number of hubs in cascade	Maximum number of switches in cascade
10BASE-T	100 m/328 ft	100 m/328 ft	4	Unlimited
100BASE-TX	100 m/328 ft	100 m/328 ft	2	Unlimited
1000BASE-T	100 m/328 ft	100 m/328 ft	–	Unlimited
10BASE-FL	2,000 m/6,561 ft	3,100 m/10,170 ft (2)	11 (fiber ring)	–
100BASE-FX	412 m/1,351 ft 2,000 m/6,561 ft	4,000 m/13,123 ft with multimode fiber, 32,500 m/106,627 ft with singlemode fiber (3)	–	Unlimited
1000BASE-SX	275 m/902 ft	–	–	Unlimited

(1) Based on 802.3, full duplex/half duplex.

(2) Depends on the optical fiber budget and fiber attenuation.

(3) Depends on the optical fiber budget and fiber attenuation, typical specification is 2,000 m/6,561 ft for multimode and 15,000 m/49,212 ft for singlemode.

Physical media

The Ethernet 802.3 standard defines the physical layer. A summary of the most common media is given below:

Type	Data rate	Cable type		Connector type	
		Defined by 802.3	Recommended by Schneider Electric	Defined by 802.3	Recommended by Schneider Electric
10BASE-T	10 Mbps	CAT 3 - UTP	CAT 5E - STP	RJ45	RJ45
100BASE-TX	100 Mbps	CAT 5 - UTP	CAT 5E - STP	RJ45	RJ45
1000BASE-T	1 Gbps	CAT 5 - UTP	CAT 5E - STP	RJ45	RJ45
10BASE-FL	10 Mbps	Two multimode optical fiber cables typically 62.5/125 µm fiber, 850 nm light wavelength	Two multimode optical fiber cables typically 62.5/125 µm fiber, 850 nm light wavelength	ST	ST
100BASE-FX	100 Mbps	Two multimode optical fibers typically 62.5/125 µm multimode fiber, 1,300 nm light wavelength	Two multimode optical fibers typically 62.5/125 µm multimode fiber, 1,300 nm light wavelength	ST	SC
		–	Two monomode optical fibers typically 9/125 µm multimode fiber, 1,300 nm light wavelength	–	SC
1000BASE-SX	1 Gbps	Two 62.5/125 or 50/125 multimode optical fibers, 770 to 860 nm light wavelength	Two 62.5/125 µm or 50/125 m multimode optical fibers, 1,300 nm light wavelength	SC	LC
1000BASE-LX	1 Gbps	–	Two 9/125 µm singlemode optical fibers, 1,300 nm light wavelength	–	LC

Note: These specifications are defined by IEEE 802.3. However, some cables are no longer being developed. For instance, for 10BASE-T and 100BASE-TX, a CAT-5E cable is used.

Device management

Ethernet devices in general (end-of-line devices and cabling devices) can be divided into two categories: unmanaged and managed devices.

- **Unmanaged** devices are devices for which there is no option to configure or control any of the device parameters.
- **Managed** devices are devices whose parameters can be configured or controlled (managed) and their internal data can be accessed.

The Modicon Switch product line offers both types of device.

There is also a third, unspecified category of device, which is normally classified as a "managed device". However, there is one major difference: although this device allows access to its internal data, it cannot be controlled and/or configured.

Managed devices

Managed devices offer the following features:

- **Traffic optimization and filtering** - The aim is to increase the bandwidth or the traffic capacity in a network (some of the features in this area are message and port priority, flow control, multicast filtering, broadcast limiting, IGMP snooping, Vlan, etc.).
- **VLAN** - A virtual LAN (VLAN) consists of a group of network participants in one or more network segments that can communicate with each other as if they belonged to the same LAN.
VLANs are based on logical (instead of physical) links. The biggest advantage of VLANs is their possibility of forming user groups based on the participant function and not on their physical location or medium.
Since broad/multicast data packets are transmitted exclusively within a virtual LAN, the remaining data network is unaffected. VLAN can also serve as a security mechanism to block unwanted Unicast messages.
- **Security** - This feature helps the user protect the switch from unauthorized access that could result in changes in its configuration and impact the traffic going through the switch (some of the features in this area are port security, read/write community name, etc.).
Users can also set up the switch so that it blocks messages coming from unauthorized "device" source addresses connected to the switch.
- **Time synchronization** - This feature allows all devices in a network to be synchronized according to the time.
- **Network redundancy** - This helps to develop high availability applications.
- **Dual ring switch (DRS)** - These switches are provided with predefined settings to optimize communication performance and help save time in Ethernet RIO architectures with Modicon Quantum and Modicon M580 automation platforms. DRSs are mandatory for building Ethernet RIO architectures in which sub-rings have to be connected to the main Ethernet ring.

Redundancy

To develop high-availability applications, “redundancy” in the networking infrastructure is the answer. Developers can help avoid losing network segments by implementing a single ring or a coupled ring architecture.

Single ring

The first level of redundancy is achieved by implementing a single ring. Modicon switches allow the set up of backbone ring configurations.

Modicon switches support three redundancy protocols: HIPER-Ring, MRP, and RSTP.

The ring is constructed using HIPER-Ring ports. If an error is detected in one section of the line, a ring structure of up to 50 switches transforms back to a line-type configuration within 0.5 seconds.

With a Modicon Quantum or a Modicon M580 Ethernet RIO architecture, the recovery loop can be optimized to less than 50 ms thanks to the RSTP protocol implemented in the different devices.

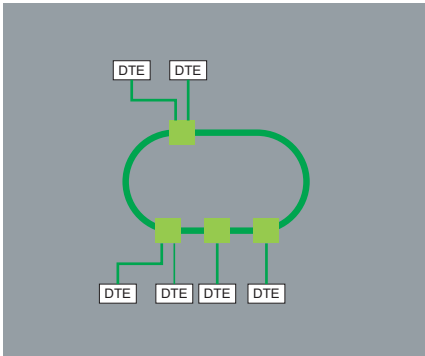

Single ring topology

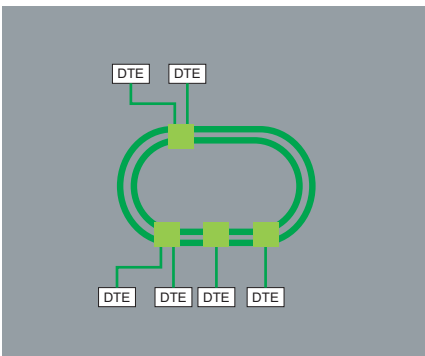

Dual ring topology

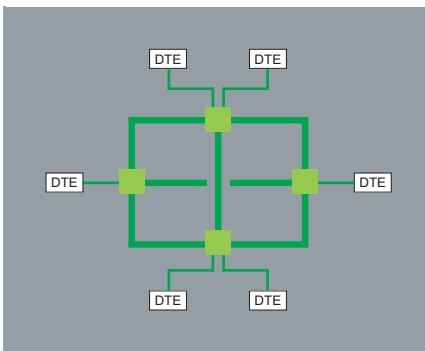

Mesh topology

Dual ring

The second level of redundancy is achieved by implementing a dual ring. The control intelligence built into Modicon switches allows the redundant coupling of HIPER-Rings and network segments.

As for a single ring, the recovery time can be optimized to less than 50 ms for 16 switches or 32 RIO drop adapters thanks to the RSTP protocol.

Mesh topology using the rapid “Spanning Tree” protocol

A third level of redundancy can be achieved by implementing a mesh topology. In simple terms, “Spanning Tree” is a protocol that provides a single path for the signal, when multiple paths exist. If the active path is broken, the “Spanning Tree” protocol enables one of the alternative paths.

Modicon switches offer this possibility.

Security

Modicon firewalls help improve security for industrial networks while meeting the needs for cybersecurity.

Firewall rules can be defined to control access levels at the host, protocol, and port levels.

Further rules can be defined for other purposes, such as protecting access to Modbus/TCP function codes and register levels, or EtherNet/IP CIP objects and service codes.

ConneXium firewalls can also offer layer 3 routing, network address translation (NAT), and virtual private networks (VPN) for advanced security zoning of critical industrial networks.

5 - Dedicated parts for severe environments

Treatment for severe environments

- **Presentation**..... [page 5/2](#)
- Protective treatment for Modicon M340 [page 5/2](#)
- Treatment for severe environments [page 5/2](#)
 - Harsh chemical environments [page 5/2](#)
 - Extreme climate environments [page 5/2](#)
 - Corrosive environments..... [page 5/2](#)
- M340 offer composition for severe environments [page 5/3](#)

Dedicated parts for severe environments

- **M340 Processors for severe environments**..... [page 5/3](#)
- Processors, references..... [page 5/3](#)
- **M340 Communication modules for severe environments**..... [page 5/3](#)
- M340 Ethernet communication modules..... [page 5/3](#)
- M580/M340 RTU communication module..... [page 5/3](#)



Presentation

Protective treatment for Modicon M340 automation platform

The Modicon M340 automation platform complies with "TC" treatment requirements (treatment for all climates). It is designed as standard to operate in temperatures ranging from 0 to +60 °C/32 to 140 °F.

For installations in industrial environments corresponding to "TH" (treatment for hot and humid environments), devices must be housed in enclosures providing at least IP54 protection as specified by standard IEC/EN 60529, or an equivalent level of protection according to NEMA 250.

The Modicon M340 automation platform offers **IP20 protection** (1). It can therefore be installed without an enclosure in reserved access areas that do not exceed **pollution level 2** (control room with no conductive dust). **Pollution level 2** does not take account of harsher environments, such as those where the air is polluted with conductive dust, fumes, corrosive or radioactive particles, vapors or salts, molds, insects, etc.

Treatment for severe environments

If the Modicon M340 automation platform has to be used in more severe environments or is required to start and operate in an extended temperature range, from **-25 °C to +70 °C/-13 °F to 158 °F** (only H or T version), the "ruggedized" offer features industrially hardened processors, power supply modules, communication modules, I/O modules, and racks that have a protective coating on their circuit boards.

Note: Capable of starting within an extended temperature range (from -25 °C to +70 °C/-13 °F to 158 °F, a single-rack configuration is also able to operate at extremely low temperatures (as low as -40 °C/-40 °F) if placed in an appropriate enclosure. Please contact our Customer Care Center.

The coated/harsh offer provides the CPU/coprocessor and modules with "AVR 80" coating on their electronic cards. This treatment increases the isolation capability of the circuit boards and their resistance to:

- Condensation
- Dusty atmospheres (conducting foreign particles)
- Chemical corrosion, in particular during use in sulfurous atmospheres (oil refinery, purification plant, etc.) or atmospheres containing halogens (chlorine, etc.) or chemical vapors

This protection, combined with appropriate installation and maintenance, enables Modicon M340 automation platform products to be used in the following environments:

Harsh chemical environments (products with suffix 'H' and 'C')

Products with suffix 'H' and 'C' meet the following requirements :

- **IEC/EN 60721-3-3 class 3C1, 3C2, 3C3, 3C4:**
 - 7 days; 25 °C/77 °F relative humidity 75%
 - Concentrations (ppb): H₂S: 9,900/SO₂: 4,800/Cl₂: 200
- **ISA S71.04 classes G1, G2, G3, Gx:**
 - 14 days; 25 °C/77 °F relative humidity 75%
 - Concentrations (ppb): H₂S: 60/SO₂: 350/Cl₂: 1,450/NO₂: 12
- **IEC/EN 60068-2-52 salt mist, Kb test severity level 2:**
 - 3 x 24-hour cycles
 - 5% NaCl
 - 40 °C/104 °F relative humidity 93%

The use of contact grease protection on connectors and removal blocks is mandatory to meet these requirements. The lubricant protection seals electrical contacts from oxygen, moisture, aggressive gasses, and other hostile elements.

Extreme climate environments (products with suffix 'H' and 'T')

Products with suffix 'H' and 'T' meet the following environment conditions :

- Temperatures ranging from -25 to +70 °C/-13 to 158 °F
- Relative humidity levels up to 93% from -25 °C/-13 °F to +60 °C/140 °F
- Formation of ice
- Altitudes from 0 to 5,000 m/0 to 16,404 ft

Note: Some products with the suffix 'C' also operate in an extended temperature range (from -25 °C to +60 °C/-13 °F to 140 °F). Please contact our Customer Care Center

Corrosive environments

A protective gel is needed to cover all electrical connections on M340 products used in corrosive environments. This gel comes in a 25 g tube and can be ordered separately under the reference **BMXGEL0025**.

F19_ACC_CPMFS17008



Protective gel BMXGEL0025

(1) Each slot in a **BM•XBP••00** rack is equipped as standard with a protective cover that should only be removed when inserting a module. If any covers are subsequently misplaced, replacements can be ordered under reference **BMXXEM010** (sold in lots of 5).

Modicon M340 automation platform

Dedicated parts for severe environments
M340 Processors and communication modules

M340 offer composition for severe environments

To order ruggedized processors and modules, see the reference tables below:

- References of available ruggedized products include the suffix "H"

The majority of operating and electrical characteristics of ruggedized modules are identical to those of their equivalent standard versions. However, some characteristics are subject to either derating or limitation. Please consult our website www.se.com.

In this chapter, note that only M340 products are described.

- For X80 or M580 ruggedized products (racks, power supplies, modules, etc.) please refer to related catalog:



DIA6ED2131203EN



DIA6ED2151012EN

- For additional M340 standard accessories, please refer to [page 2/7](#).



BMXP3420302H



BMXNOE0100H

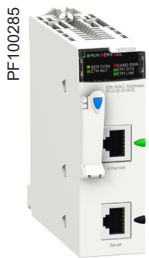

BMXNOR0200H

Modicon M340 processors for severe environments (1)

I/O capacity	Max. no. of communication modules	Integrated communication ports	Memory card	Reference	Weight kg/lb
Standard BMXP3410, 2 racks					
512 discrete I/O	2 Ethernet modules	Modbus serial link	Included	BMXP341000H	0.200/
128 analog I/O	2 AS-Interface modules				0.441
20 application-specific channels					
Performance BMXP3420, 4 racks					
1024 discrete I/O	2 Ethernet modules	Modbus serial link	Included	BMXP342020H	0.205/
256 analog I/O	4 AS-Interface modules	Ethernet Modbus/TCP			0.452
36 application-specific channels		CANopen bus	Included	BMXP3420302H	0.215/
		Ethernet Modbus/TCP			0.474

Communication modules for severe environments

Ethernet communication

Description	Data rate	Transparent ready class	Reference	Weight kg/lb
Ethernet Modbus/TCP module	10/100 Mbps	B30	BMXNOE0100H	0.200/0.441
FactoryCast Ethernet Modbus/TCP module	10/100 Mbps	C30	BMXNOE0110H	0.200/0.441

RTU communication

Description	Communication port	Protocol	Reference	Weight kg/lb
M580/M340 RTU module	1 Ethernet port 10BASE-100BASE-TX	<ul style="list-style-type: none"> ■ Modbus/TCP (client or server), Transparent Ready class C30 ■ DNP3 IP (client or server) ■ IEC 60870-5-104 (over IP) (client or server) 	BMXNOR0200H	0.205/0.452
	Serial, external modems	<ul style="list-style-type: none"> ■ DNP3 serial (master or slave) ■ IEC 60870-5-101 (master or slave) 		

(1) General characteristics are the same as those of the standard equivalent versions (see [page 2/2](#)).

Technical appendices

- Standards, certifications and environmental conditions [page 6/2](#)
- Automation product certifications and EC regulations [page 6/8](#)



Standards and certifications

Per region

The Modicon M340 automation platform has been developed to comply with the principal national and international standards concerning electronic equipment for industrial automation systems. Up-to-date information on which certifications have been obtained is available on our website: consult commercial references directly.

- Compliance with European Directives for CE marking:
 - WEEE: 2012/19/EU
 - Low voltage: 2014/35/EU
 - Electromagnetic compatibility: 2014/30/EU
 - Machinery: 2006/42/EC (check EU DoC on our website www.se.com)
 - ATEX: 2014/34/EU (check EU DoC on our website www.se.com)
- Requirements specific to programmable controllers (functional characteristics, immunity, resistance, safety, etc.):
 - IEC/EN 61131-2
 - IEC/EN/UL/CSA 61010-2-201
- Country specific passport:
 - RCM
 - EAC
 - UKCA

For other countries certifications, please refer to technical appendix [page 6/8](#).

M340 PACs are considered as open equipment and are designed for use in industrial environments, in pollution degree 2, overvoltage category II (IEC 60664-1), and in low-voltage installations, where the main power branch is protected on both wires by devices such as fuses or circuit breakers limiting the current to 15A for North America and 16A for the rest of the world.

Per application

Power generation

- EC/EN 61000-6-5 for interfaces type 1 and 2
- IEC/EN 61850-3 for locations G

Merchant navy

Merchant navy requirements of the major international organizations are unified in IACS (International Association of Classification Societies) IACS E10 rules: ABS, BV, DNV, LR, RINA, RMRS, RRR, CCS, KRS, Class NK (refer to [page 6/8](#)).

Hazardous areas

- For USA and Canada: Hazardous location class I, division 2, groups A,B,C, and D
- For European Union: ATEX for atmosphere Zone 2 (gas) and Zone 22 (dust)
- For United Kingdom: UKEX for atmosphere Zone 2 (gas) and Zone 22 (dust)
- For other countries: IECEx for atmosphere Zone 2 (gas) and/or Zone 22 (dust)

Railway

- EN 50155/IEC 60571: Railway applications - Rolling stock - Electronic equipment
- EN 50121-3-2/IEC 62236-3-2: Railway applications - Electromagnetic compatibility - Part 3-2: Rolling stock - Apparatus
- EN 50121-4/IEC 62236-4: Railway applications - Electromagnetic compatibility - Part 4: Emission and immunity of the signalling and telecommunications apparatus
- EN 50121-5/IEC 62236-5: Railway applications - Electromagnetic compatibility - Part 5: Emission and immunity of fixed power supply installations and apparatus

IACS



Modicon M340 automation platform

Standards, certifications, and environment conditions

Environmental characteristics

Service conditions and recommendations relating to the environment

			Modicon M340 automation platform	Modicon M340 modules for severe environments
Temperature	Operation	°C/°F	0...+60/32...140	-25...+70/-13...+158
	Storage	°C/°F	-40...+85/-40...+185	-40...+85/-40...+185
Relative humidity (without condensation)	Cyclical humidity	%	+5 ... +95 up to 55 °C/131 °F	+5 ... +95 up to 55 °C/131 °F
	Continuous humidity	%	+5 ... +93 up to 55 °C/131 °F	+5 ... +93 up to 60 °C/140 °F
Altitude	Operation	m/ft	0...2,000/0...6,562 (full specification: temperature and isolation) 2,000...5,000/6,562...16,404 (temperature derating: approx. 1 °C/400 m (33.8 °F/1,312 ft), isolation 150 V/1,000 m/3,281 ft For accurate temperature derating calculation, refer to IEC 61131-2 Ed4.0 Annex A	

Modicon X80 power supplies

Supply voltage	Modicon X80 power supplies					
		BMXCPS2010	BMXCPS3020 BMXCPS3020H BMXCPS4022 BMXCPS4022H	BMXCPS3540T BMXCPS3522	BMXCPS2000	BMXCPS3500 BMXCPS3500H BMXCPS4002 BMXCPS4002H
Nominal voltage	V	24 ---	24...48 ---	125 ---	100...240 ~	100...240 ~
Limit voltages	V	18...31.2 ---	18...62.4 ---	100...150 ---	85...264 ~	85...264 ~
Nominal frequencies	Hz	—	—	—	50/60	50/60
Limit frequencies	Hz	—	—	—	47/63	47/63

Protective treatment of the Modicon M340 automation platform

The Modicon M340 platform meets the requirements of “TC” treatment (treatment for all climates).

For installations in industrial production workshops or environments corresponding to “TH” treatment (treatment for hot and humid environments), Modicon M340 automation platform must be embedded in enclosures with minimum IP54 protection.

The Modicon M340 platform offers **protection to IP20 level** and **protection against access to terminals** (enclosed equipment) (1). They can therefore be installed without an enclosure in reserved-access areas that do not exceed **pollution level 2** (control room with no dust-producing machine or activity). Pollution level 2 does not take account of more severe environmental conditions: air pollution by dust, smoke, corrosive or radioactive particles, vapors or salts, molds, insects, etc.

6

Installation restrictions and recommendations

Please note that in order to fulfill the international certification conditions:

- Devices must be installed, wired, and maintained in accordance with the instructions provided in the manual “Grounding and Electromagnetic Compatibility of PLC Systems”
- Installation restrictions are provided in the manual “Modicon M580, M340, X80 I/O Platforms, Standards and Certifications”.

Download manuals for further details:



EIO0000002726

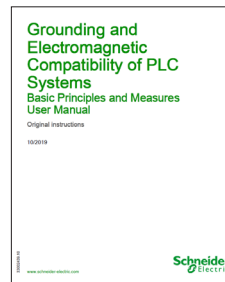

33002439K01000

(1) In cases where a slot is not occupied by a module, a BMXXEM010 protective cover must be installed.

(CE): Tests required by European directives (CE) and based on IEC/EN 61131-2 standards.

Environment tests		
Name of test	Standards	Levels
Immunity to LF interference (CE) (1)		
Voltage and frequency variations	IEC/EN 61131-2; IEC/EN 61000-6-2; IEC 61000-4-11 IACS E10; IEC 61000-4-11	0.85...1.10 Un - 0.94...1.04 Fn; 4 steps t = 30 min 0.80 Un...0.90 Fn; 1.20 Un...1.10 Fn; t = 1.5 s/5 s
Direct voltage variations	IEC/EN 61131-2; IEC 61000-4-29; IACS E10 (PLC not connected to charging battery)	0.85...1.2 Un + ripple: 5% peak; 2 steps t = 30 min
Third harmonic	IEC/EN 61131-2	H3 (10% Un), 0°/180°; 2 steps t = 5 min
Immunity to conducted low frequency (only IACS)	IACS E10	For ~ : ■ H2...H15 (10% Un), H15...H100 (10%...1% Un), H100...H200 (1% Un) For - : ■ H2...H200 (10% Un)
Voltage interruptions	IEC/EN 61131-2; IEC/EN 61000-6-2; IEC 61000-4-11; IEC 61000-4-29; IACS E10 For functional safety (DS criteria): IEC 61000-6-7; IEC 61326-3-1 IEC/EN 61131-2; IEC/EN 61000-6-2; IEC 61000-4-11	Power supply immunity: ■ 1 ms for - PS1/10 ms for ~ PS2 (20 ms DS criteria), 85% Un ■ Check operating mode for longer interruptions ■ up to 5s, 85% Un ■ for IACS, 3 times 30 s in 5 min, 85% Un For ~ PS2: ■ 20% Un, t0: ½ period ■ 40% Un, cycle 10/12 ■ 70% Un, cycle: 25/30 ■ 0% Un, cycle 250/300
Voltage shut-down and start-up	IEC/EN 61131-2	■ Un...0...Un; t = Un/60 s ■ Umin...0...Umin; t = Umin/5 s ■ Umin...0.9 Udl...Umin; t = Umin/60 s
Magnetic field	IEC/EN 61131-2; IEC 61000-4-8; IEC 61000-6-5; IEC 61850-3 For functional safety (DS criteria): IEC 61000-6-7; IEC 61326-3-1 IEC 61000-4-10	Power frequency: 50/60 Hz, 100 A/m continuous ...1000 A/m; t = 3 s; 3 axes Oscillatory: 100 kHz...1 MHz, 100 A/m; t = 9 s; 3 axes
Conducted common mode disturbances range 0 Hz ...150 kHz	IEC 61000-4-16; IEC 61000-6-5; IEC 61850-3 For functional safety (DS criteria): IEC 61000-6-7; IEC 61326-3-1	For remote systems: ■ 50/60 Hz and - , 300 V, t = 1 s ■ 50/60 Hz and ~ , 30 V, t = 1 min ■ 5 Hz...150 kHz, sweep 3 V...30 V ■ For AC: 10 V ■ For DC: 10 V cont. or 100 V, t = 1 s

Where:
 ■ PS1 applies to PLC supplied by battery, PS2 applies to PLC energized from ~ or - supplies
 ■ Un: nominal voltage, Fn: nominal frequency, Udl: detection level when powered

(1) These tests are performed without an enclosure, with devices fixed on a metal grid, and installed, wired and maintained in accordance with the instructions provided in the "Grounding and Electromagnetic Compatibility of PLC systems" manual (see page 6/3).

(CE): Tests required by European CE directives and based on IEC/EN 61131-2.

Environment tests (continued)		
Name of test	Standards	Levels
Immunity to HF interference (CE) (1)		
Electrostatic discharges	IEC/EN 61131-2; IEC/EN 61000-6-2; IEC 61000-6-5; IEC 61850-3; IEC 61000-4-2; IACS E10 For functional safety (DS criteria): IEC 61000-6-7; IEC 61326-3-1	6 kV contact; 8 kV air; 6 kV indirect contact
Radiated radio frequency electromagnetic field	IEC/EN 61131-2; IEC/EN 61000-6-2; IEC 61000-6-5; IEC 61850-3; IEC 61000-4-3; IACS E10 For functional safety (DS criteria): IEC 61000-6-7; IEC 61326-3-1	80MHz...1GHz: 10/15 V/m (20 V/m DS criteria); 3 V/m, 1.4 GHz...2 GHz: 3V/m (10 V/m DS criteria) 2 GHz...6 GHz: 3V/m Sinus amplitude modulated 80%, 1 kHz + internal clock frequencies
Electrical fast transient bursts	IEC/EN 61131-2; IEC/EN 61000-6-2; IEC 61000-6-5; IEC 61850-3; IEC 61000-4-4; IACS E10 For functional safety (DS criteria): IEC 61000-6-7; IEC 61326-3-1	For ~ or --- main supplies: ■ 2 kV in common mode/2 kV in wire mode (4 kV DS criteria with external protection) For ~ or --- auxiliary supplies, ~ unshielded I/O: ■ 2 kV in common mode For analog, --- unshielded I/O, communication and shielded lines: ■ 1 kV in common mode (3 kV DS criteria)
Surge	IEC/EN 61131-2; IEC/EN 61000-6-2; IEC 61000-6-5; IEC 61850-3; IEC 61000-4-5; IACS E10 For functional safety (DS criteria): IEC 61000-6-7; IEC 61326-3-1	For ~/--- main and auxiliary supplies, ~ unshielded I/O: ■ 2 kV in common mode/1 kV in differential mode (4 kV DS criteria with external protection) For analog, --- unshielded I/O: ■ 2 kV in common mode/2 kV in differential mode For communication and shielded lines: ■ 1 kV in common mode (3 kV DS criteria)
Conducted disturbances induced by radiated electromagnetic fields	IEC/EN 61131-2; IEC/EN 61000-6-2; IEC 61000-6-5; IEC 61850-3; IEC 61000-4-6; IACS E10 For functional safety (DS criteria): IEC 61000-6-7; IEC 61326-3-1	10 V; 0.15 MHz...80 MHz (20 V DS criteria) Sinus amplitude 80%, 1 kHz + spot frequencies
Damped oscillatory wave	IEC/EN 61131-2; IEC 61000-6-5; IEC 61850-3; IEC 61000-4-18; IACS E10	For ~/--- main supplies and ~ auxiliary supplies, ~ unshielded I/O: ■ 2.5 kV in common mode/1 kV in differential mode For --- auxiliary supplies, analog, --- unshielded I/O: ■ 1 kV in common mode/0.5 kV in differential mode For communication and shielded lines: ■ 0.5 kV in common mode

(1) These tests are performed without an enclosure, with devices fixed on a metal grid, and installed, wired and maintained in accordance with the instructions provided in the "Grounding and Electromagnetic Compatibility of PLC systems" manual (see page 6/3).

(CE): Tests required by European CE directives and based on IEC/EN 61131-2.

Environment tests (continued)		
Name of test	Standards	Levels
Electromagnetic emissions (CE) (1)		
Conducted emissions	IEC/EN 61131-2; IEC/EN 61000-6-4; CISPR 11 & 22, Class A, Group 1	150 kHz ... 500 kHz: quasi-peak 79 dB (µV/m); average 66 dB (µV/m) 500 kHz ... 30 MHz: quasi-peak 73 dB (µV/m); average 60 dB (µV/m)
	IACS E10	<ul style="list-style-type: none"> ■ ~ power (general power distribution zone): 10 kHz ... 150 kHz: quasi-peak 120...69 dB (µV/m); 150 kHz ... 0.5 MHz: quasi-peak 79 dB (µV/m) 0.5 MHz ... 30 MHz: quasi-peak 73 dB (µV/m) ■ ~ power (bridge and deck zone for evaluation): 10 kHz ... 150 kHz: quasi-peak 96...50 dB (µV/m) 150 kHz ... 0.35 MHz: quasi-peak 60...50 dB (µV/m) 0.35 MHz ... 30 MHz: quasi-peak 50 dB (µV/m)
Radiated emissions	IEC/EN 61131-2; IEC/EN 61000-6-4; CISPR 11 & 22, Class A, Group 1	30 MHz ... 230 MHz: quasi-peak 40 dB (µV/m) (at 10 m/33 ft) 230 MHz ... 1 GHz: quasi-peak 47 dB (µV/m) (at 10 m/33 ft) 1 GHz ... 3 GHz: quasi-peak 76 dB (µV/m) (at 3 m/9.84 ft) 3 GHz ... 6 GHz: quasi-peak 80 dB (µV/m) (at 3 m/9.84 ft)
	IACS E10	<ul style="list-style-type: none"> ■ For general power distribution zone 0.15 MHz ... 30 Mhz: quasi-peak 80...50 dB (µV/m) (at 3 m/9.84 ft) 30 MHz-100 MHz: quasi-peak 60...54 dB (µV/m) (at 3 m/9.84 ft) 100 MHz - 2 GHz: quasi-peak 54 dB (µV/m) (at 3 m/9.84 ft) 156 ... 165 MHz: quasi-peak 24 dB (µV/m) (at 3 m/9.84 ft)
Immunity to climatic variations (1) (power on)		
Dry heat	IEC 60068-2-2 (Bb & Bd)	60 °C/140 °F, t = 16 hrs [for ruggedized range: 70 °C/158 °F, t = 16 hrs] (2)
	IACS E10	70 °C/140 °F, t = 16 hrs
Cold	IEC 60068-2-1 (Ab & Ad); IACS E10	0 °C...-25 °C/32 °F...-13 °F, t = 16 hrs + power on at 0 °C/32 °F [for ruggedized range: power on at -25 °C/-13 °F] (2)
Damp heat, steady state (continuous humidity)	IEC 60068-2-78 (Cab); IACS E10	55 °C/131 °F, 93% relative humidity, t = 96 hrs [for ruggedized range: 60 °C/140 °F] (2)
Damp heat, cyclic (cyclical humidity)	IEC 60068-2-30 (Db); IACS E10	55 °C...25 °C/131 °F...77 °F, 93...95% relative humidity, 2 cycles t = 12 hrs + 12 hrs
Change of temperature	IEC 60068-2-14 (Nb)	0 °C ... 60 °C/32 °F...140 °F, 5 cycles t = 6 hrs + 6 hrs [for ruggedized range: -25 °C...70 °C/-13 °F...158 °F] (2)
Withstand to climatic variations (1) (power off)		
Dry heat	IEC/EN 61131-2; IEC 60068-2-2 (Bb & Bd); IEC/EN 60945	85 °C/185 °F, t = 96 hrs
Cold	IEC/EN 61131-2; IEC 60068-2-1 (Ab & Ad); IACS E10	-40 °C/-40 °F, t = 96 hrs
Damp heat, cyclic (cyclical humidity)	IEC/EN 61131-2; IEC 60068-2-30 (Db)	55 °C...25 °C/77 °F...131 °F, 93...95% relative humidity, 2 cycles t = 12 hrs + 12 hrs
Change of temperature (thermal shocks)	IEC/EN 61131-2; IEC 60068-2-14 (Na)	-40 °C...85 °C/-40 °F...185 °F, 5 cycles t = 3 hrs + 3 hrs

(1) Devices must be installed, wired, and maintained in accordance with the instructions provided in the manual "Grounding and Electromagnetic Compatibility of PLC Systems" (see page 6/3).

(2) Refer also to the section "Treatment for severe environments" (see page 5/2).

(CE): Tests required by European CE directives and based on IEC/EN 61131-2 standards.

Environment tests (continued)		
Name of test	Standards	Levels
Immunity to mechanical constraints (1) (power on)		
Sinusoidal vibrations	IEC/EN 61131-2; IEC 60068-2-6 (Fc)	Basic IEC/EN 61131-2: 5 Hz ... 150 Hz, ± 3.5 mm/0.14 in. amplitude (5 Hz ... 8.4 Hz), 1 g (8.4 Hz ... 150 Hz) Specific profile: 5 Hz ... 150 Hz, ± 10.4 mm/0.41 in. amplitude (5 Hz ... 8.4 Hz), 3 g (8.4 Hz ... 150 Hz) For basic and specific: endurance: 10 sweep cycles for each axis
	IEC 60870-2-2; IEC 60068-2-6 (Class Cm)	2 Hz ... 500 Hz, 7 mm/0.28 in. amplitude (2 Hz ... 9 Hz), 2 g (9 Hz ... 200 Hz), 1.5 g (200 Hz ... 500 Hz) endurance: 10 sweep cycles for each axis
	IACS E10	3 Hz ... 100 Hz, 1 mm/0.04 in. amplitude (3 Hz ... 13.2 Hz), 0.7 g (13.2 Hz ... 100 Hz) Endurance at each resonance frequency: 90 min for each axis, amplification coefficient < 10
	IEC 60068-2-6	Seismic analysis: 3 Hz ... 35 Hz, 22.5 mm/0.89 in. amplitude (3 Hz ... 8.1 Hz), 6 g (8.1 Hz ... 35 Hz)
Shocks	IEC/EN 61131-2; IEC 60068-2-27 (Ea)	30 g, 11 ms; 3 shocks/direction/axis (2)
Free fall during operation	IEC/EN 61131-2; IEC 60068-2-32 (Ed Method 1)	1 m/3.28 ft, 2 falls
Withstand to mechanical constraints (power off)		
Random free fall with packaging	IEC/EN 61131-2; IEC 60068-2-32 (Method 1)	1 m/3.28 ft, 5 falls
Flat free fall	IEC/EN 61131-2; IEC 60068-2-32 (Ed Method 1)	10 cm/0.33 ft, 2 falls
Controlled free fall	IEC/EN 61131-2; IEC 60068-2-31 (Ec)	30° or 10 cm/0.33 ft, 2 falls
Plugging/Unplugging	IEC/EN 61131-2	For modules and connectors: Operations: 50 for permanent connections, 500 for non-permanent connections
Equipment and personnel safety (1) (CE)		
Dielectric strength and insulation resistance	IEC/EN 61131-2; IEC 61010-2-201; UL; CSA	Dielectric: 2 Un + 1000 V; t = 1 min Insulation: Un ≤ 50 V: 10 MΩ, 50 V ≤ Un ≤ 250 V: 100 MΩ
Ground continuity	IEC/EN 61131-2; IEC 61010-2-201; UL; CSA	30A, R ≤ 0,1Ω; t = 2 min
Leakage current	IEC/EN 61131-2; IEC 61010-2-201; UL; CSA	≤ 0.5 mA in normal condition ≤ 3.5 mA in single fault condition
Protection offered by enclosures	IEC/EN 61131-2; IEC 61010-2-201	IP20 and protection against standardized pins
Impact withstand	IEC/EN 61131-2; IEC 61010-2-201; UL; CSA	Sphere of 500 g, fall from 1.3 m/4.27 ft (energy 6.8 J minimum)
Overload	IEC/EN 61131-2; IEC 61010-2-201; UL; CSA	50 cycles, Un, 1.5 In; t = 1 s ON + 9 s OFF
Endurance	IEC/EN 61131-2; IEC 61010-2-201; UL; CSA	In, Un; 6,000 cycles: t = 1 s ON + 9 s OFF
Temperature rise	IEC/EN 61131-2; UL; CSA; ATEX; IECEx	Ambient temperature 60 °C/140 °F [for ruggedized range: 70 °C/158 °F] (4)
Specific environment (4)		
Corrosion areas - gas, salt, dust	ISA S71.4	Flowing mixed gas; class Gx, 25 °C/77 °F, 75% relative humidity, t = 14 days
	IEC/EN 60721-3-3; IEC 60068-2-60	Flowing mixed gas; class 3C3, 25 °C/77 °F, 75% relative humidity, t = 14 days
	IEC/EN 60721-3-3; IEC 60068-2-60	Flowing mixed gas; class 3C4, 25 °C/77 °F, 75% relative humidity, t = 7 days
	IEC 60068-2-52	Salt spray: test Kb, severity 2
	IEC/EN 60721-3-3; IEC 60068-2-68	Dust and sand, Arizona dust, class 3S4, 20 cycles
	IEC/EN 60721-3-3; IEC 60068-2-10	Mold growth, fungal spore, class 3B2, t=28 days

(1) Devices must be installed, wired, and maintained in accordance with the instructions provided in the manual "Grounding and Electromagnetic Compatibility of PLC Systems" (see page 6/3).

(2) When using fast actuators (response time ≤ 5 ms) driven by relay outputs: 15 g, 11 ms; 3 shocks/direction/axis.

(3) When using fast actuators (response time ≤ 15 ms) driven by relay outputs: 15 g, 6 ms; 100 bumps/direction/axis.

(4) Refer also to the section "Treatment for severe environments" (see page 5/2).

(CE): Tests required by European CE directives and based on IEC/EN 61131-2 standards.

Technical appendices

Automation product certifications and EC regulations

Some countries require certain electrical components to undergo certification by law. This certification takes the form of a certificate of conformity to the relevant standards and is issued by the official body in question. Where applicable, certified devices must be labeled accordingly. Use of electrical equipment on board merchant vessels generally implies that it has gained prior approval (i.e. certification) by certain shipping classification societies.









Abbreviation	Certification body / authority	Country
CE	European Community	European Union
UL	Underwriters Laboratories	USA
CSA	Canadian Standards Association	Canada
RCM	Australian Communications and Media Authority	Australia, New Zealand
EAC	Eurasian conformity	Russia and Eurasian Economic Union
UKCA	United Kingdom Central Authority	United Kingdom
cULus	Underwriters Laboratories	USA, Canada
cCSAus	Canadian Standards Association	Canada, USA
IECEX	International Electrotechnical Commission Explosive	International
ATEX	ATmosphères EXplosives	International
TÜV Rheinland (Functional Safety)	Technischer Überwachungsverein Rheinland	International
ABS	American Bureau of Shipping	USA
BV	Bureau Veritas	France
DNV	Det Norske Veritas	Norway, Germany
LR	Lloyd's Register	UK
RINA	Registro Italiano Navale	Italy
RMRS	Russian Maritime Register of Shipping	Russia
RRR	Russian River Register	Russia
CCS	China Classification Society	China
KRS	Korean Register of Shipping	Korea
Class NK	Nippon Kaiji Kyokai	Japan

Note: Although DNV GL rebranded to DNV as of March 1st, 2021, all certificates with DNV GL name and logo keep their initial validity date. Only rules in force on or after March 1st, 2021, are rebranded to DNV.

The following tables provide an overview of the situation as of September 2021, in terms of which certifications (listed next to their respective bodies) have been granted or are pending for our automation products.

Up-to-date information on which certifications have been obtained by products bearing the Schneider Electric brand can be viewed on our website: www.se.com.

Product certifications

	Certifications								
	 CE	 UL	 CSA	 RCM	 EAC	 UKCA	 UL - CSA Hazardous locations (1)	 ATEX - IECEX	 TÜV Rheinland
	EU	USA	Canada	Australia	Russia	UK	USA, Canada	International	Germany
Modicon STB							Cl. I, Div. 2, Grps ABCD	Zone 2 (2) (4)	
Modicon Telefast ABE 7									
Modicon Switch			(3)				Cl. I, Div. 2, Grps ABCD (2)	Zone 2 (2)	
Modicon MC80							Cl. I, Div. 2, Grps ABCD		
Modicon M340							Cl. I, Div. 2, Grps ABCD	Zone 2/22 (2) (5)	
Modicon M580							Cl. I, Div. 2, Grps ABCD	Zone 2/22 (2) (5)	
Modicon M580 Safety							Cl. I, Div. 2, Grps ABCD	Zone 2/22 (2) (5)	SIL3, SILCL3, SIL4, Cat.4/PLe (6)
Modicon X80							Cl. I, Div. 2, Grps ABCD	Zone 2/22 (2) (5)	
Modicon Momentum							Cl. I, Div. 2, Grps ABCD		
Modicon Quantum					(2)		Cl. I, Div. 2, Grps ABCD	Zone 2/22 (2) (5)	

(1) Refer to user manual for installation in hazardous locations.

(2) Depends on product; Refer to the product certificates at www.se.com.

(3) North American certification cULus (Canada and USA).

(4) For zones not covered by this specification, Schneider Electric offers a solution as part of the TPP (Technology Partner Program). Please contact our Customer Care Center.

(5) Certified by INERIS. Refer to the instructions supplied with each ATEX and/or IECEX certified product.











(6) Certified by TÜV Rheinland for integration into a Safety function:

- up to SIL2 or SIL3 regarding IEC61508/61511 for Process,
- up to SILCL3 regarding IEC62061 and up to Cat.4/PLe regarding ISO13849 for Machine,
- up to SIL4 regarding EN50126/50128/50129 for Railway.

Technical appendices

Automation product certifications and EC regulations

Merchant navy certifications

Certification status	Shipping classification societies									
										
	ABS	BV	DNV	LR	RINA	RMRS	RRR	CCS	KRS	Class NK
	USA	France	Norway/ Germany	Great Britain	Italy	Russia	Russia	China	Korea	Japan
Certified										
Certification pending										
Only part of range certified										
Modicon STB										
Modicon Telefast ABE 7										
Modicon Switch		(1)	(1)	(1)						
Modicon MC80										
Modicon M340										
Modicon M580										
Modicon M580 Safety										
Modicon X80										
Modicon Momentum										
Modicon Quantum										

EC regulations

European Directives

The open nature of the European markets assumes harmonization between the regulations set by the member states of the European Union. European Directives are texts intended to remove restrictions on free circulation of goods and must be applied within all European Union states.

Member states are obligated to incorporate each Directive into their national legislation, and to simultaneously withdraw any regulations that contradict it.

Directives - and particularly those of a technical nature with which we are concerned - merely set out the objectives to be fulfilled (referred to as "essential requirements"). Manufacturers are responsible for taking the necessary measures to establish that their products conform to the requirements of each Directive applicable to their equipment.

As a general rule, manufacturers certify compliance with the essential requirements of the Directive(s) that apply to their products by applying a CE mark. The CE mark is affixed to our products where applicable.

Significance of the CE mark

The CE mark on a product indicates the manufacturer's certification that the product conforms to the relevant European Directives; this is a prerequisite for placing a product that is subject to the requirements of one or more Directives on the market and allowing its free circulation within European Union countries. The CE mark is intended for use by those responsible for regulating national markets.

Where electrical equipment is concerned, conformity to standards indicates that the product is fit for use. Only a warranty by a well-known manufacturer can provide reassurance of a high level of quality.

As far as our products are concerned, one or more Directives are likely to apply in each case; in particular:

- The Low Voltage Directive (2014/35/EU)
- The Electromagnetic Compatibility Directive (2014/30/EU)
- The ATEX CE Directive (2014/34/EU)
- The Machinery Directive (2006/42/EU)

Hazardous substances

These products are compatible with:

- The WEEE Directive (2012/19/EU)
- The RoHS Directive (2011/65/EU)
- The China RoHS Directive (Standard GB/T 26572-2011)
- REACH regulations (EC No. 1907/2006)

Note: Documentation on sustainable development is available on our website www.se.com (product environmental profiles and instructions for use, RoHS and REACH directives).

End of life (WEEE)

End of life products containing electronic cards must be dealt with by specific treatment processes.

When products containing backup batteries are unusable or at end of life they must be collected and treated separately. Batteries do not contain a percentage by weight of heavy metals above the limit specified by European Directive 2013/56/EU.

(1) Please refer to the Modicon Networking catalog for more details.

Dedicated service offers for your installed base

- Maintenance and support services [page 7/2](#)
- Consultancy services [page 7/3](#)
- Modernization solutions [page 7/3](#)
- Customization services [page 7/3](#)

Index

- Product reference index [page 7/4](#)

Dedicated service offers for your installed base



Schneider Electric, with its experts, products, and dedicated tools, provides services such as system design, consultancy, maintenance contracts, modernization of facilities, and project delivery.

The Schneider Electric services offer is structured around several key areas:

- Maintenance and support services:
 - A set of services to help maintain reliability and availability of automated control systems. These services may be the subject of a bespoke maintenance contract to meet your requirements more closely.
- Consultancy services:
 - Diagnostics of the installed base
- Modernization solutions:
 - Migration solutions including consultancy, expertise, tools, and technical support to help ensure a smooth transition to newer technology while keeping the wiring and encoding in most cases.

Customization services are also available to accommodate specific requirements. For more information, please consult the specific pages on our website www.se.com/automationservices.

Maintenance and support services

Spare parts, exchanges, and repairs

Everything you need to get equipment working again as quickly as possible

Solutions to respond very quickly to requests for spare parts, exchanges, and repairs to your installed automation equipment (automation platforms, Human Machine Interfaces, drives, distributed I/O):

- Spare parts management:
 - Identification of critical parts
 - Stock of spare parts: a Schneider Electric owned stock of spare parts, on your site or in one of our warehouses, with immediate availability on site or a contractually agreed delivery time if stored off site
 - Testing of spare parts stored on site
 - Automatic stock filling
- Repairs:
 - Products that have broken down are repaired in a network of worldwide repair centers. For each repaired product, our experts provide a detailed report.
- On-site repair:
 - Our experts' knowledge and expertise
 - Monitoring of specific repair procedures
 - Availability of our teams to respond 24/7
- Exchanges:
 - With standard replacements, receive a new or reconditioned product before the product that has broken down has even been sent back
 - Fast exchanges offer the option to receive the replacement product within 24 hours (in Europe)

Preventive maintenance

Improving and helping to ensure the long-term reliability and performance of your installations

Schneider Electric's preventive maintenance expert assesses your site and the equipment to be managed and sets up a maintenance program to accommodate your specific requirements. A list is provided of the tasks to be performed and their frequency, including site-specific tasks, describing how preventive maintenance is to be managed.

Extended warranty

An additional manufacturer warranty covering replacement or repair of the equipment

The extended warranty offers the option to take out a 3-year warranty. The warranty period can vary according to the geographical area (please contact your Customer Care Center for more information).

Online support

Access to dedicated experts

Priority access to experts who can answer technical questions promptly concerning equipment and software both on sale and no longer commercially available.

Software subscription

Access to software upgrades and new features

By subscribing to software updates, users are able to:

- Purchase licences
- Receive updates, upgrades, software migrations, and transitions
- Download software from Schneider Electric's software library

Consultancy services

M2C (Maintenance and Modernization Consultancy)

Professional tools and methods, proven experience of managing obsolescence and updating installed bases, helping to reduce downtimes and improve performance

With our maintenance and modernization consultancy offer, Schneider Electric will help you check the state of your installed base by:

- Defining the scope and depth of the analysis in collaboration with you
- Collecting the technical data without shutting down production
- Analyzing and identifying avenues for improvement
- Producing a recommendation plan

Customer benefits:

- Learning about the components that make up the installed base and how up-to-date they are
- Better downtime anticipation
- Expert advice designed to improve performance

Modernization solutions

Migration to EcoStruxure

Proven expertise, tools, and methods to give you a clear vision of the improvement opportunities and guide you towards a successful modernization project



Find out more about EcoStruxure architectures on our website www.se.com

Schneider Electric offers gradual solutions of modernization through a set of products, tools, and services that allow you to upgrade your installations with our latest technologies. Our solutions offer you the choice to plan your modernization:

- Partial modernization: replacement of an old set of components with a new one
- Step-by-step modernization: gradual incorporation of new solutions or offers in the system
- Complete modernization: total renovation of the system

The table below lists our various migration offers:

Wide range of migration offers		Moving to M580/M340/X80 platform						
Solution		Solution type			Tools	Solution services		
		Change the CPU and retain the I/O racks and wiring	Change the CPU and the I/O racks and retain I/O field wiring with wiring system	Change the CPU, the I/O racks and the I/O wiring	SoftWare application conversion tool	Modernization/migration service	Manage your project	Execute your project
Platform	Premium	☑	☑	☑	☑	☑	☑	☑
	TSX47 to TSX107		☑	☑	☑	☑	☑	☑
	Quantum	☑	☑	☑	☑	☑	☑	☑
	Modicon 984 & 800 Series I/O	☑	☑	☑	☑	☑	☑	☑
	Modicon Compact		☑	☑	☑	☑	☑	☑
	Symax	☑	(1)	☑	☑	☑	☑	☑
	April series 1000		(2)	☑	☑	☑	☑	☑
	April SMC			☑	☑	☑	☑	☑
	Merlin Gerin PB			☑		☑	☑	☑
	AEG		(1)	☑		☑	☑	☑
	Rockwell SLC500		☑	☑	☑	☑	☑	☑
	Rockwell PLC 5	☑	☑	☑	☑	☑	☑	☑
	Siemens S5 et S7			☑	☑	☑	☑	☑

☑ Service available

(1) Consult Schneider Services - project-specific solution is possible
 (2) For April Series 1000 (April 5000-7000 and April 2000-3000)
 Consult Schneider Services - project-specific solution is possible

Customization services

Schneider Electric is able to meet your specific requirements and provide you with adapted products:

- Protective coating for HMIs, automation platforms, and distributed I/O modules for use in harsh environments
- Customized cable lengths to match your specific needs
- Customized front panels for HMIs
- The preparation of the multi-use flying lead I/O adapter can be made in the factory before use on request.

Note: To check availability of services required, please contact our Customer Care Center.



B

BMXNOC0401	3/27 4/9
BMXNOE0100	3/25 4/9
BMXNOE0100H	5/3
BMXNOE0110	3/25 4/9
BMXNOE0110H	5/3
BMXNOR0200H	3/31 5/3
BMXP341000	2/6 3/19 4/8
BMXP341000H	5/3
BMXP342000	2/6 4/8
BMXP342000	3/19
BMXP3420102	2/6 3/14 3/19 4/8
BMXP3420102CL	2/6 3/14 3/19 4/8
BMXP342020	2/6 3/14 3/24 4/8
BMXP342020H	5/3
BMXP3420302	2/6 3/14 3/24 4/8
BMXP3420302CL	2/6 3/14 3/24 4/8
BMXP3420302H	5/3
BMXRMS008MP	2/7
BMXRMS008MPF	2/7
BMXRMS128MPF	2/7
BMXRWS128MWF	3/31
BMXRWSB000M	3/25
BMXRWSFC032M	3/25
BMXXBE1000	4/8
BMXXBE2005	4/8
BMXXCAUSBH018	2/7
BMXXCAUSBH045	2/7

F

FTXCY1208	3/17
FTXCY1212	3/17

T

TCSCCN2M2F03	3/17
TCSCCN2M2F1	3/17
TCSCCN2M2F2	3/17
TCSCCN2M2F5	3/17
TCSCCN4F3M05T	3/16
TCSCCN4F3M1T	3/16
TCSCCN4F3M3T	3/16
TCSCTN011M11F	3/16
TM7ACTLA	3/17
TSXCANCA100	3/16
TSXCANCA300	3/16
TSXCANCA50	3/16

TSXCANCADD1	3/16
TSXCANCADD3	3/16
TSXCANCB100	3/16
TSXCANCB300	3/16
TSXCANCB50	3/16
TSXCANCBDD1	3/16
TSXCANCBDD3	3/16
TSXCANCD100	3/16
TSXCANCD300	3/16
TSXCANCD50	3/16
TSXCANKCDF180T	3/16
TSXCANKCDF90T	3/16
TSXCANKCDF90TP	3/16
TSXCANTDM4	3/16

V

VW3CANA71	3/16
VW3CANCARR03	3/16
VW3CANCARR1	3/16
VW3CANKCDF180T	3/16
VW3CANTAP2	3/16
VW3M3805R010	3/16

X

XZCC12FCM50B	3/17
XZCC12FDB50R	3/16
XZCC12FDM50B	3/17
XZCC12MCM50B	3/17
XZCC12MDB50R	3/16
XZCC12MDM50B	3/17

Life Is On



Learn more about our products at
www.se.com

The information provided in this documentation contains general descriptions and/or technical characteristics of the performance of the products contained herein. This documentation is not intended as a substitute for and is not to be used for determining suitability or reliability of these products for specific user applications. It is the duty of any such user or integrator to perform the appropriate and complete risk analysis, evaluation and testing of the products with respect to the relevant specific application or use thereof. Neither Schneider Electric nor any of its affiliates or subsidiaries shall be responsible or liable for misuse of the information contained herein.

Design: Schneider Electric
Photos: Schneider Electric

Schneider Electric Industries SAS

Head Office
35, rue Joseph Monier - CS 30323
F-92500 Rueil-Malmaison Cedex
France

DIA6ED2110104EN
November 2021 - V7.0