



Main

Range of product	Modicon TM5
Product or component type	Mixed I/O module
Range compatibility	Modicon LMC058 Modicon M258
Product compatibility	Motion controller Logic controller

Complementary

Discrete input number	4
Discrete input voltage	24 V
Discrete input voltage type	DC
Input voltage limits	20.4...28.8 V
Discrete input logic	Sink
Discrete input current	3.3 mA
Voltage state 0 guaranteed	≤ 5 V
Voltage state 1 guaranteed	≥ 15 V
Input filtering	≤ 2 μ s hardware 1 ms by default ≤ 25 ms configurable by software
Analogue input number	1
Analogue input type	Voltage ± 10 V Current 0...20 mA/4...20 mA
Analogue input resolution	12 bits + sign voltage 12 bits current
Common mode rejection	70 dB DC analog input 70 dB 50 Hz analog input
Discrete output number	2
Discrete output type	Transistor
Output voltage	24 V DC
Output voltage limits	20.4...28.8 V
Discrete output logic	Source
Discrete output current	≤ 0.5 A per output ≤ 1 A
Peak output current	14 A
Maximum leakage current	5 μ A when switched off) digital output
Switching frequency	100 Hz, resistive digital output
Analogue output number	1
Analogue output type	Voltage ± 10 V Current 0...20 mA
Conversion time	300 μ s analog output
Analogue output resolution	12 bits + sign, ± 10 V 12 bits, 0...20 mA
Measurement resolution	2.441 mV, ± 10 V, ± 10 V 4.883 μ A, 0...20 mA/4...20 mA, 0...20 mA
Color	White

The information provided in this documentation contains general descriptions and/or technical characteristics of the performance of the products contained herein. This documentation is not intended as a substitute for and is not to be used for determining suitability or reliability of these products for specific user applications. It is the duty of any such user or integrator to perform the appropriate and complete risk analysis, evaluation and testing of the products with respect to the relevant specific application or use thereof. Neither Schneider Electric Industries SAS nor any of its affiliates or subsidiaries shall be responsible or liable for misuse of the information contained herein.

Response time	<= 250 µs from state 0 to state 1 digital output <= 250 µs from state 1 to state 0 digital output 1 ms analog output
Input impedance	7.18 kOhm digital >= 1 MOhm analog, +/- 10 V
Minimum output impedance	1 KOhm +/- 10 V 32...131 °F (0...55 °C) 10 kOhm +/- 10 V 131...140 °F (55...60 °C)
Load impedance ohmic	<= 400 Ohm0...20 mA) 32...131 °F (0...55 °C) <= 300 Ohm0...20 mA) 131...140 °F (55...60 °C) <= 300 Ohm 0...20 mA/4...20 mA)
Sampling duration	300 µs analog input
Measurement error	< 0.08 % of full scale +/- 10 V) 25 °C < 0.08 % of full scale 0...20 mA/4...20 mA) 25 °C < 0.15 % of full scale +/- 10 V) 25 °C < 0.15 % of full scale 0...20 mA) 25 °C
Temperature coefficient	+/- 0.009 %FS/°C 0...20 mA/4...20 mA) +/- 0.006 %FS/°C +/- 10 V) +/- 0.02 %FS/°C 0...20 mA) +/- 0.02 %FS/°C +/- 10 V)
Non-linearity	+/- 0.02 %FS 0...20 mA/4...20 mA) +/- 0.02 %FS +/- 10 V) +/- 0.1 %FS 0...20 mA) +/- 0.1 %FS +/- 10 V)
Type of cable	Shielded cable
Isolation	No insulation between channels 500 Vrms AC insulation between channel and bus
Supply	Internal
[Us] rated supply voltage	24 V DC -15...20 %
Local signalling	For power supply (ON) 1 LED (green) For power supply (OFF) 1 LED (red) For digital input status 4 LEDs (green) For digital output status 2 LEDs (orange) 1 LED (orange) 1 LED (green)
Wiring mode	1 wire digital input/output
Current consumption	2 mA at 5 V DC bus 73 mA 24 V DC inputs/outputs
Maximum power dissipation in W	1.75 W
Protection type	Against reverse polarity digital output Against short-circuits digital output Thermal overload protection digital output Against short-circuits analog output
Marking	CE
Net Weight	0.06 lb(US) (0.025 kg)

Environment

Standards	IEC 61131-2 CSA C22.2 No 142 UL 508 CSA C22.2 No 213
Product certifications	C-tick CSA CULus GOST-R
Ambient air temperature for operation	32...131 °F (0...55 °C) without derating horizontal installation) 131...140 °F (55...60 °C) with derating factor horizontal installation) 32...122 °F (0...50 °C) vertical installation)
Ambient air temperature for storage	-13...158 °F (-25...70 °C)
Relative humidity	5...95 % without condensation
IP degree of protection	IP20IEC 61131-2
Pollution degree	2 IEC 60664
Operating altitude	0...6561.68 ft (0...2000 m)
Storage altitude	0.00...9842.52 ft (0...3000 m)
Vibration resistance	1 gn 8.4...150 Hz DIN rail 3.5 mm 5...8.4 Hz DIN rail
Shock resistance	15 gn 11 ms

Resistance to electrostatic discharge	4 KV on contact EN/IEC 61000-4-2 8 kV in air EN/IEC 61000-4-2
Resistance to electromagnetic fields	0.91 V/M (1 V/m) 2...2.7 GHz EN/IEC 61000-4-3 9.14 V/m (10 V/m) 80...2000 MHz EN/IEC 61000-4-3
Resistance to fast transients	1 KV EN/IEC 61000-4-4 I/O) 1 KV EN/IEC 61000-4-4 shielded cable) 2 kV EN/IEC 61000-4-4 power lines)
Surge withstand	0.5 KV differential mode EN/IEC 61000-4-5 1 kV common mode EN/IEC 61000-4-5
Electromagnetic compatibility	EN/IEC 61000-4-6
Disturbance radiated/conducted	CISPR 11

Ordering and shipping details

Category	22532 - M258 PLC
Discount Schedule	PC12
GTIN	00785901373537
Nbr. of units in pkg.	1
Package weight(Lbs)	0.1 lb(US) (0.05 kg)
Returnability	No
Country of origin	AT

Packing Units

Unit Type of Package 1	PCE
Package 1 Height	0.79 in (2 cm)
Package 1 width	2.36 in (6 cm)
Package 1 Length	4.13 in (10.5 cm)

Offer Sustainability

California proposition 65	WARNING: This product can expose you to chemicals including: Lead and lead compounds which is known to the State of California to cause Carcinogen & Reproductive harm. For more information go to www.p65warnings.ca.gov
---------------------------	---

Contractual warranty

Warranty	18 months
----------	-----------

TM5 Slice

Dimensions

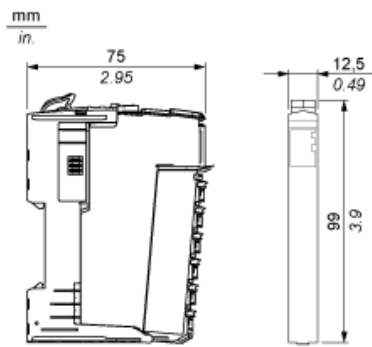

TM5 System

Spacing Requirements

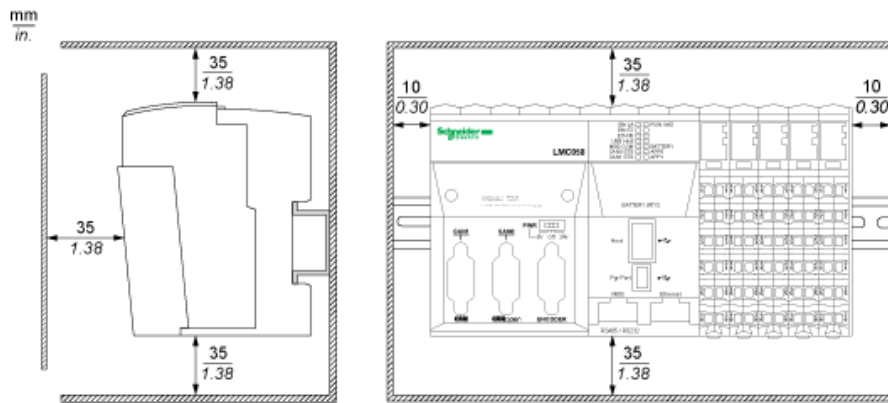



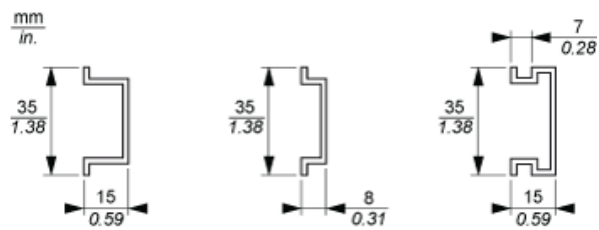

Mounting on a DIN Rail



TM5 System Wiring Recommendations

Wire Sizes to Use with the Removable Spring Terminal Blocks

mm in.				
mm ²	0,08...2,5	0,25...2,5	0,25...1,5	2 x 0,25...2 x 0,75
AWG	28...14	24...14	24...16	2 x 24...2 x 18

Wiring Diagram

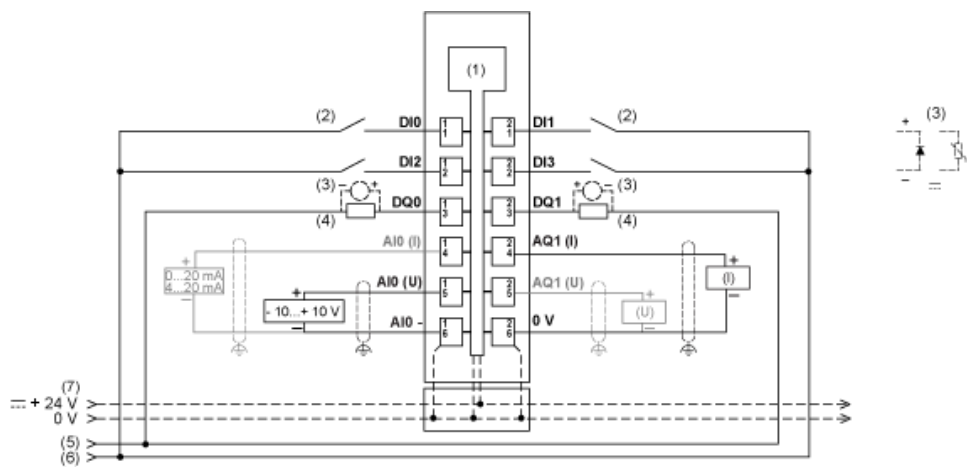

- 1 internal electronics
- 2 2-wire sensor
- 3 inductive load protection
- 4 2-wire load
- 5 0 Vdc I/O power segment by external connection
- 6 24 Vdc I/O power segment by external connection
- 7 24 Vdc I/O power segment integrated into the bus bases
- I current
- U voltage