

# ZBRT1

Transmitter for wireless and batteryless push button, plastic, black



## Main

Range of product	Harmony XB5
Product or component type	Wireless and batteryless transmitter
Device short name	XB5R
Bezel material	Plastic
Mounting diameter	0.87 in (22 mm)
Transmission frequency	2405 MHz
Emission class	5M00G7W
Antenna type	Omnidirectional

## Complementary

Max power consumption in W	1 mW
Number of channels	16
Modulation technique	O-QPSK
Bandwidth	5 MHz
Antenna gain	0 dBi
Embedding depth	1.65 in (42 mm)
CAD overall height	1.63 in (41.5 mm)
CAD overall width	1.18 in (30 mm)
CAD overall depth	1.69 in (43 mm)
Net Weight	0.06 lb(US) (0.025 kg)
Operating travel	4.3 mm (total travel)
Operating force	10 N C/O changing electrical state
Mechanical robustness	Free fall resistance 1000 mm conforming to EN/IEC 60068-2-32
Standards	CSA C22.2 No 14 EN/IEC 60947-1 EN/IEC 60947-5-1 UL 508
Radio agreement	ANATEL ARIB T66 FCC ICASA RSS
Communication port protocol	Zigbee green power 2.4 GHz IEEE 802.15.4
Maximum sensing distance	328.08 Ft (100 m) in free field 82.02 Ft (25 m) transmitter in a plastic box type XAL D and receiver in a metal enclosure 984.25 ft (300 m) transmitter in box type XAL D, receiver in metal enclosure and use relay-antenna
Acquisition time	2 ms
Response time	< 2 ms
Fixing mode	Fixing nut beneath head: 2...2.4 N.m
Electrical composition code	PW1

The information provided in this documentation contains general descriptions and/or technical characteristics of the performance of the products contained herein. This documentation is not intended as a substitute for and is not to be used for determining suitability or reliability of these products for specific user applications. It is the duty of any such user or integrator to perform the appropriate and complete risk analysis, evaluation and testing of the products with respect to the relevant specific application or use thereof. Neither Schneider Electric Industries SAS nor any of its affiliates or subsidiaries shall be responsible or liable for misuse of the information contained herein.

## Environment

Ambient air temperature for storage	-40...158 °F (-40...70 °C)
Ambient air temperature for operation	-40...158 °F (-40...70 °C)
Relative humidity	95 % -40...158 °F (-40...70 °C) without condensation
IP degree of protection	IP30 IEC 60529 back face)
IK degree of protection	IK03 conforming to IEC 50102
Mechanical durability	1000000 cycles
Shock resistance	25 gn 6 ms) 6000 shocks IEC 60068-2-27 30 gn (duration = 18 ms) for half sine wave acceleration conforming to IEC 60068-2-27 50 gn (duration = 11 ms) for half sine wave acceleration conforming to IEC 60068-2-27
Vibration resistance	5 gn 11...500 Hz)IEC 60068-2-6 +/- 10 mm (f= 2...11 Hz) conforming to IEC 60068-2-6
Electromagnetic compatibility	Electrostatic discharge immunity test 8 kV in free air (in insulating parts)) IEC 61000-4-2 Electrostatic discharge immunity test 4 kV on contact (on metal parts)) IEC 61000-4-2 Susceptibility to electromagnetic fields 20 V/m 80...3000 MHz) IEC 61000-4-3 Susceptibility to electromagnetic fields 6 V/m 3000...6000 MHz, distance = 20 m) IEC 61000-4-3
Product certifications	CSA GOST CCC C-tick UL BT 2006/95/EC
Directives	1999/5/EC - R&TTE directive 2004/108/EC - electromagnetic compatibility





## Ordering and shipping details

Category	22470 - XB5R WIRELESS PUSH BUTTON
Discount Schedule	I
GTIN	00785901590101
Nbr. of units in pkg.	1
Package weight(Lbs)	0.07 lb(US) (0.03 kg)
Returnability	Yes
Country of origin	FR

## Packing Units

Package 1 Height	0.570 dm
Package 1 width	0.450 dm
Package 1 Length	0.530 dm

## Offer Sustainability

Sustainable offer status	Green Premium product
California proposition 65	WARNING: This product can expose you to chemicals including: Lead and lead compounds, which is known to the State of California to cause cancer and birth defects or other reproductive harm. For more information go to <a href="http://www.P65Warnings.ca.gov">www.P65Warnings.ca.gov</a>
REACH Regulation	 <a href="#">REACH Declaration</a>
REACH free of SVHC	Yes
EU RoHS Directive	Pro-active compliance (Product out of EU RoHS legal scope)  <a href="#">EU RoHS Declaration</a>
Mercury free	Yes
RoHS exemption information	 <a href="#">Yes</a>
China RoHS Regulation	 <a href="#">China RoHS Declaration</a>
Environmental Disclosure	 <a href="#">Product Environmental Profile</a>

Circularity Profile	<a href="#">End Of Life Information</a>
WEEE	The product must be disposed on European Union markets following specific waste collection and never end up in rubbish bins.
PVC free	Yes
Silicon free	Yes

### Contractual warranty

Warranty	18 months
----------	-----------

Dimensions Drawings

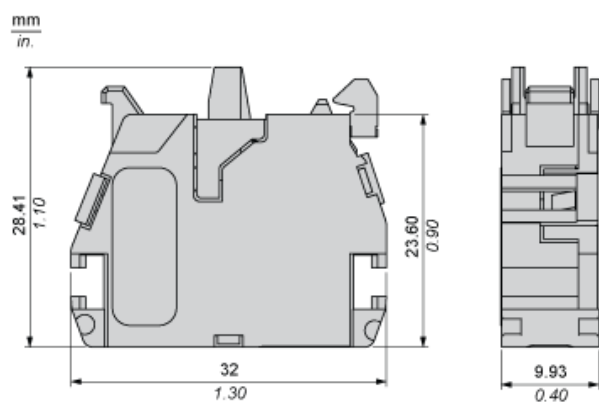

---

## Mounting of the Transmitter onto the Body Fixing Collar

---

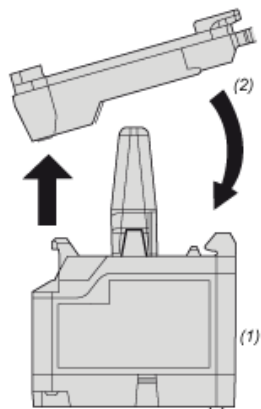

- (1): ZBRT1
- (2): Body fixing collar