

# XPSMCMENx

## Instruction Sheet (Original Language)

04/2018

---

The information provided in this documentation contains general descriptions and/or technical characteristics of the performance of the products contained herein. This documentation is not intended as a substitute for and is not to be used for determining suitability or reliability of these products for specific user applications. It is the duty of any such user or integrator to perform the appropriate and complete risk analysis, evaluation and testing of the products with respect to the relevant specific application or use thereof. Neither Schneider Electric nor any of its affiliates or subsidiaries shall be responsible or liable for misuse of the information contained herein. If you have any suggestions for improvements or amendments or have found errors in this publication, please notify us.

You agree not to reproduce, other than for your own personal, noncommercial use, all or part of this document on any medium whatsoever without permission of Schneider Electric, given in writing. You also agree not to establish any hypertext links to this document or its content. Schneider Electric does not grant any right or license for the personal and noncommercial use of the document or its content, except for a non-exclusive license to consult it on an "as is" basis, at your own risk. All other rights are reserved.

All pertinent state, regional, and local safety regulations must be observed when installing and using this product. For reasons of safety and to help ensure compliance with documented system data, only the manufacturer should perform repairs to components.

When devices are used for applications with technical safety requirements, the relevant instructions must be followed.

Failure to use Schneider Electric software or approved software with our hardware products may result in injury, harm, or improper operating results.

Failure to observe this information can result in injury or equipment damage.

© 2018 Schneider Electric. All Rights Reserved.

---

# Table of Contents



---

About the Book .....	5
XPSMCMENx Expansion Modules .....	7





---

### At a Glance

#### Document Scope

This information is about the usage and configuration of the XPSMCMEN0200•, XPSMCMEN0100HT•, XPSMCMEN0200HT•, XPSMCMEN0100SC•, XPSMCMEN0200SC•, XPSMCMEN0100TT•, and XPSMCMEN0200TT• expansion modules for the XPSMCMCP0802• Modular Safety Controller.

#### Validity Note

The characteristics that are presented in the present manual should be the same as those characteristics that appear online. In line with our policy of constant improvement, we may revise content over time to improve clarity and accuracy. If you see a difference between the manual and online information, use the online information as your reference.

#### Product Related Information

The XPSMCM• is built to the following safety integrity levels: SIL 3 according to EN/IEC 61508, SILcl 3 according to EN/IEC 62061, PL e category 4 according to EN ISO 13849-1 in accordance with the applicable standards. However, the definitive SIL and PL of the application depends on the number of safety-related components, their parameters, and the connections that are made, as per the risk analysis.

The module must be configured in accordance with the application-specific risk analysis and all the applicable standards.

Pay particular attention in conforming to any safety information, different electrical requirements, and normative standards that would apply to your adaptation.

 <b>WARNING</b>
<b>UNINTENDED EQUIPMENT OPERATION</b>
Perform an in-depth risk analysis to determine the appropriate safety integrity level for your specific application, based on all the applicable standards.
<b>Failure to follow these instructions can result in death, serious injury, or equipment damage.</b>

**NOTE:** Configuration of the module is the sole responsibility of the installer or user.

For all matters concerning functional safety, if necessary, contact the competent safety authorities or the competent trade associations of your country.

Consult the specific product documentation and the relative product and/or application standards to ensure correct use of modules connected to the XPSMCMEN0200•, XPSMCMEN0100HT•, XPSMCMEN0200HT•, XPSMCMEN0100SC•, XPSMCMEN0200SC•, XPSMCMEN0100TT•, and XPSMCMEN0200TT• modules within your specific application.

---

The ambient temperature of the installed system must be compatible with the operating temperature parameters stated on the product label and in the product specifications.

---

## XPSMCMENx Expansion Modules

### Safety-related Information

**NOTE:** The safety-related function can be compromised if this module is not used for the intended purpose and in accordance with the instructions in the present document. This module must only be used as safety-related equipment on machines intended to protect persons, material, and installations.

## DANGER

### HAZARD OF ELECTRIC SHOCK, EXPLOSION OR ARC FLASH

- Do not install, operate, or maintain this equipment unless you are a trained professional electrician and qualified to perform these activities.
- Install and use this equipment only in locations known to be non-hazardous.
- Do not use the equipment described herein to supply external drives or contactors.
- Use the same ground supply (0 Vdc) to supply all modules of the Modular Safety Controller family.
- Disconnect all power from all equipment including connected input devices, contactors, and drives prior to removing any covers or doors, or installing or removing any accessories, hardware, cables, or wires.
- If connected drives or contactors contain stored energy, allow sufficient time after the removal of power for the stored energy to discharge in accordance with the instructions for those drives and contactors.
- Always use a properly rated voltage sensing equipment to confirm that the power is removed.
- Avoid contacting terminals with hand or tools until the power has been confirmed removed.
- Follow all electrical safety regulations and standards (for example, lockout/tag-out, phase grounding, barriers) to reduce the possibility of contact with hazardous voltages in the work area.
- Remove locks, tags, barriers, temporary ground straps, and replace and secure all covers, doors, accessories, hardware, cables, and wires and confirm that a proper ground connection exists before reapplying power to the unit.
- Complete thorough hardware tests and system commissioning to verify that line voltages are not present on the control circuits before using your hardware operationally.
- Use only the specified voltage when operating this equipment and any associated products.

**Failure to follow these instructions will result in death or serious injury.**

---

## DANGER

### LOSS OF DESIGNATED SAFETY FUNCTION

- Install the XPSMCM• Modular Safety Controller system in an enclosure with a degree of protection of at least IP 54.
- Always use an isolated power supply (PELV) to help prevent the application of line voltages to control circuitry in the case of short-circuits.

**Failure to follow these instructions will result in death or serious injury.**

## DANGER

### POTENTIAL FOR EXPLOSION OR UNINTENDED EQUIPMENT OPERATION

- Install and use the Modular Safety Controller in non-hazardous locations only.
- Do not use the Modular Safety Controller system for life support systems.

**Failure to follow these instructions will result in death or serious injury.**

**NOTE:** The observation of operating limits and duty cycles is of particular importance for equipment designed to perform a safety-related function. If this module has been subjected to electrical, mechanical, or environmental stresses in excess of its stated limits, do not use it.

## WARNING

### UNINTENDED EQUIPMENT OPERATION

- Do not exceed any of the rated operating limits for the equipment specified in the present document.
- Immediately cease using and replace any equipment that has or might have been subjected to conditions in excess of its rated operating limits.

**Failure to follow these instructions can result in death, serious injury, or equipment damage.**

### User Responsibilities

The information provided in this documentation contains general descriptions and/or technical characteristics of the performance of the products contained herein. This documentation is not intended as a substitute for and is not to be used for determining suitability or reliability of these products for specific user applications. It is the duty of any such user, machine builder, or system integrator to perform the appropriate and complete risk analysis, evaluation, and testing of the products with respect to the relevant specific application or use thereof.



Neither Schneider Electric nor any of its affiliates or subsidiaries shall be responsible or liable for misuse of the information contained herein. If you have any suggestions for improvements or amendments or have found discrepancies in this publication, notify Schneider Electric. All pertinent safety regulations must be observed when installing and using this product. For reasons of safety and to help ensure compliance with documented system data, only the manufacturer should perform repairs to components.

### Qualified Personnel

Electrical equipment should be installed, operated, serviced, and maintained only by qualified personnel. A qualified person is one who has skills and knowledge related to the construction and operation of this electrical equipment and its installation, and has received safety training to recognize and avoid the hazards involved.

### Modular Safety Controller

Key safety values	Value	Standard
Probability of a dangerous failure per hour (PFHd)	Refer to module-specific characteristics.	IEC 61508
Safety Integrity Level (SIL)	3	
Hardware Fault Tolerance (HFT)	1 (type B)	
Defined "Safe state" <sup>1</sup>	All outputs off	
Safety Integrity Level claim limit (SILcl)	3	IEC 62061
Type	4	EN 61496-1
Performance Level (PL) <sup>2</sup>	e	EN ISO 13849-1
Diagnostic Coverage <sub>avg</sub>	High	
Mean Time to Dangerous Failure (MTTFd)	2500 years with Category 4 architecture, otherwise 100 years <sup>3</sup>	
Category <sup>2</sup>	4	
Maximum service life	20 years	
<p><sup>1</sup> The Modular Safety Controller and expansion modules are in the defined safe state when their outputs are off. To exit the defined safe state condition, a combination of hardware inputs is required.</p> <p><sup>2</sup> The EN ISO 13849-1 performance level (PL) and safety category (Cat) of the overall system depends on multiple factors, including the selected modules, wiring practices, the physical environment, and the application.</p> <p><sup>3</sup> If expansion modules are added to the configuration, the MTTFd of the overall system is affected, refer to the SoSafe Configurable Project Report.</p>		

## WARNING

### UNINTENDED EQUIPMENT OPERATION

- You must carry out a risk assessment in accordance with EN ISO 14121-1.
- Validate the entire system/machine in accordance with the required performance level and risk assessment.

**Failure to follow these instructions can result in death, serious injury, or equipment damage.**

### Module and Function Description

The XPSMCMEN0200•, XPSMCMEN0100HT•, XPSMCMEN0200HT•, XPSMCMEN0100SC•, XPSMCMEN0200SC•, XPSMCMEN0100TT•, and XPSMCMEN0200TT• are speed monitoring expansion modules for zero speed, maximum speed, speed range and direction monitoring. In addition, you can configure up to four speed thresholds for each axis being monitored.

The XPSMCMEN0200•, XPSMCMEN0100HT•, XPSMCMEN0200HT•, XPSMCMEN0100SC•, XPSMCMEN0200SC•, XPSMCMEN0100TT•, and XPSMCMEN0200TT• modules can only be configured in conjunction with the XPSMCMCP0802• Modular Safety Controller.

- The XPSMCMEN0200 and XPSMCMEN0200G module contains two proximity sensor safety-related inputs.
- The XPSMCMEN0100HT• and XPSMCMEN0200HT• modules contain two proximity sensor inputs and one or two channels respectively for HTL safety encoder monitoring.
- The XPSMCMEN0100SC• and XPSMCMEN0200SC• modules contain two proximity sensor inputs and one or two channels respectively for Sin/Cos safety encoder monitoring.
- The XPSMCMEN0100TT• and XPSMCMEN0200TT• modules contain two proximity sensor inputs and one or two channels respectively for TTL safety encoder monitoring.

**NOTE:** The encoders must be mounted according to EN 61800-5-2 to the shaft of the motor.

The modules can be configured using SoSafe Configurable software.

**Node Address:** The XPSMCMEN0200•, XPSMCMEN0100HT•, XPSMCMEN0200HT•, XPSMCMEN0100SC•, XPSMCMEN0200SC•, XPSMCMEN0100TT•, and XPSMCMEN0200TT• modules contain two node address inputs: `NODE_ADDR0` and `NODE_ADDR1`.

The `NODE_ADDR0` and `NODE_ADDR1` inputs (on the expansion modules) are used to attribute a physical address to the modules with the connections presented in the table:



NODE	NODE_ADDR1 (Terminal 3)	NODE_ADDR0 (Terminal 2)
NODE 0	0 (or not connected)	0 (or not connected)
NODE 1	0 (or not connected)	24 Vdc
NODE 2	24 Vdc	0 (or not connected)

NODE	NODE_ADDR1 (Terminal 3)	NODE_ADDR0 (Terminal 2)
NODE 3	24 Vdc	24 Vdc

**NOTE:** It is not allowed to use the same physical address for two units of the same module reference.

## Terminals

**Examples with maximum number of terminals. Regarding terminal designation, refer to table below.**

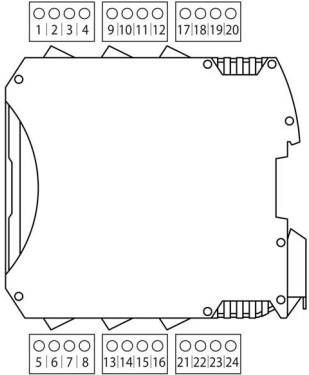
Screw terminals example	Spring terminals example	Terminal numbers
		

### XPSMCMEN• modules

Terminal	Signal	LED	Type	Description	Operation
1	24 VDC	PWR	–	24 Vdc power supply	–
2	NODE_ADDR0	ADDR0	Input	Node selection	Input type 3. Maximum applicable resistance 1.2 kΩ.
3	NODE_ADDR1	ADDR1			
4	0 VDC	PWR	–	0 Vdc power supply	–
5	PROXY1_24V	PROXY1	Output	PROXIMITY 1 connections	Maximum current 100 mA
6	PROXY1_REF				Power supply 0 Vdc to PROXY1
7	PROXY1_IN1 (3-wire)		Input		PROXY1 Input_1 for NO or NC contact
8	PROXY1_IN2 (4-wire)				PROXY1 Input_2 for NO or NC contact

Terminal	Signal	LED	Type	Description	Operation
9	PROXY2_24V	PROX2	Output	PROXIMITY 2 connections	Maximum current 100 mA
10	PROXY2_REF				Power supply 0 Vdc to PROXY2
11	PROXY2_IN1 (3-wire)		Input		PROXY2 Input_1 for NO or NC contact
12	PROXY2_IN2 (4-wire)				PROXY2 Input_2 for NO or NC contact
13	not connected	–	–	not connected	–
14					
15					
16					

Encoder connections with RJ45 connector (modules XPSMCMEN0100HT•, XPSMCMEN0200HT•, XPSMCMEN0100SC•, XPSMCMEN0200SC•, XPSMCMEN0100TT•, and XPSMCMEN0200TT•)

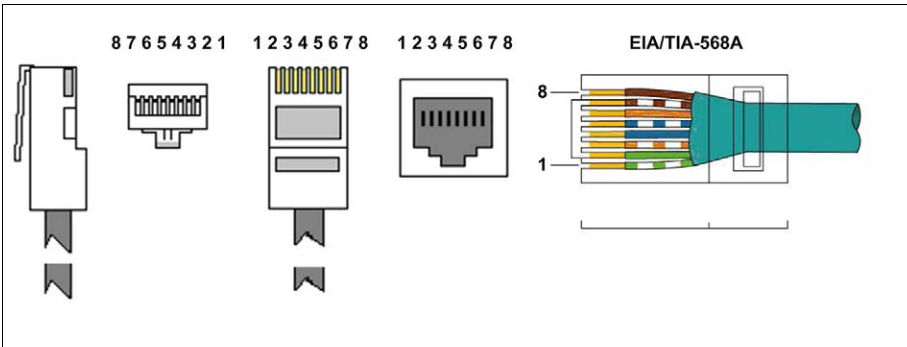

Pin	Color	XPSMCMEN0•00TT	XPSMCMEN0•00HT	XPSMCMEN0•00SC
1	green - white	5 Vdc <sup>(1)</sup>	not connected	not connected
2	green	0 Vdc	0 Vdc	0 Vdc
3	orange - white	not connected	not connected	not connected
4	blue	A	A	A (Sin+)
5	blue-white	/A	/A	/A (Sin-)
6	orange	not connected	not connected	not connected
7	brown-white	B	B	B (Cos+)
8	brown	/B	/B	/B (Cos-)

**(1)** This pin is not the power supply of the TTL-encoder, which must be supplied separately. The pin needs to be connected for the speed monitoring module to detect the presence of a TTL-encoder.

## Dimensions

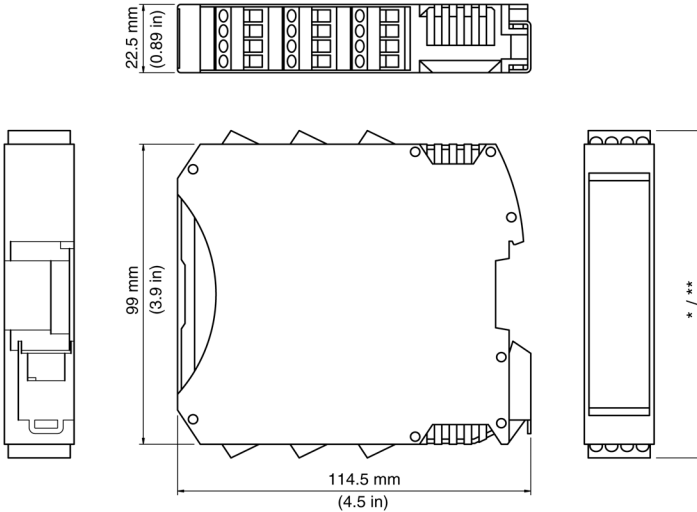









- \* Screw terminals 108 mm (4.25 in)
- \*\* Spring terminals 118 mm (4.67 in)



Mount the modules (Modular Safety Controller and any I/O expansion modules) in an electric cabinet with an IP54 degree of protection. The minimum clearance below and above the controller is 40 mm. Allow at least 100 mm distance between the cabinet door and the front face of the module(s). There are no clearances required on the left or right side of the module(s); however, other equipment in proximity may require larger distances and those clearances must also be taken into account.

## Technical Data





### Cable types and wire sizes

for a 5.08 pitch removable **screw** terminal block

mm in.								
	7	0.28						
mm <sup>2</sup>	0.2...2.5	0.2...2.5	0.25...2.5	0.25...1.5	2 x 0.2...1	2 x 0.2...1.5	2 x 0.25...1	2 x 0.5...1.5
AWG	24...14	24...14	23...14	23...16	2 x 24...18	2 x 24...16	2 x 23...18	2 x 20...16

		N·m	0.5
Ø 3.5 mm (0.14 in.)		lb·in	4.42

for a 5.08 pitch removable **spring** terminal block (used by XPSMCM\*\*\*G).

mm in.					
	10	0.39			
mm <sup>2</sup>	0.2...2.5	0.2...2.5	0.25...2.5	0.25...2.5	2 x 0.5...1
AWG	24...14	24...14	23...14	23...14	2 x 20...18

<b>Cable types and wire sizes</b>	
The following instructions concerning connection cables must be observed:	
<ul style="list-style-type: none"> <li>● Use 60/75 °C copper (Cu) conductor only. Maximum cable length 100 m (328 ft).</li> <li>● Cables used for connections of longer than 50 m (164 ft) must have a cross-section of at least 1 mm<sup>2</sup> (AWG 16).</li> </ul>	

<b>Housing characteristics</b>	
Housing material	Polyamide
Housing degree of protection	IP20
Terminal blocks degree of protection	IP2x
Mounting	35 mm DIN rail according to EN/IEC 60715
Mounting position	Any plane
Dimensions (h x l x d)	<ul style="list-style-type: none"> <li>● with screw terminals: 108 x 22.5 x 114.5 mm (4.25 x 0.89 x 4.5 in)</li> <li>● with spring terminals: 118.5 x 22.5 x 114.5 mm (4.67 x 0.89 x 4.5 in)</li> </ul>

<b>General characteristics</b>	
Rated voltage	24 Vdc ± 20 % (PELV supply)
Dissipated power	3 W maximum
Overvoltage category	II
Ambient operating temperature	-10...+55 °C (14...131 °F)
Storage temperature	-20...+85 °C (-4...185 °F)
Relative humidity	10...95%
Maximum operation altitude	2000 m (6562 ft)
Pollution degree	2
Vibration resistance (IEC/EN 61496-1)	+/- 3.5 mm (0.138 in) 5...8.4 Hz 1 g (8.4...150 Hz)
Shock resistance (IEC/EN 61496-1)	15 g (11 ms half-sine)
EMC Category	Zone B

General characteristics			
<p><b>Response time (ms)</b></p> <p>The response time depends on the following parameters:</p> <ul style="list-style-type: none"> <li>● Number of expansion modules installed</li> <li>● Number of operators</li> <li>● Number of OSSD outputs</li> <li>● Status outputs</li> </ul> <p>For the response time, refer to the one calculated by the SoSafe Configurable software (see project report).  <math>T_{\text{Input\_filter}}</math> = filtering time set in the project for the inputs. For details, refer to the Input functions (see <i>Modular Safety Controller, User Guide</i>).</p>	Controller	10.6...12.6	+ $T_{\text{Input\_filter}}$
	Controller + 1 expansion module	11.8...26.5	+ $T_{\text{Input\_filter}}$
	Controller + 2 expansion modules	12.8...28.7	+ $T_{\text{Input\_filter}}$
	Controller + 3 expansion modules	13.9...30.8	+ $T_{\text{Input\_filter}}$
	Controller + 4 expansion modules	15...33	+ $T_{\text{Input\_filter}}$
	Controller + 5 expansion modules	16...35	+ $T_{\text{Input\_filter}}$
	Controller + 6 expansion modules	17...37.3	+ $T_{\text{Input\_filter}}$
	Controller + 7 expansion modules	18.2...39.5	+ $T_{\text{Input\_filter}}$
	Controller + 8 expansion modules	19.3...41.7	+ $T_{\text{Input\_filter}}$
	Controller + 9 expansion modules	20.4...43.8	+ $T_{\text{Input\_filter}}$
	Controller + 10 expansion modules	21.5...46	+ $T_{\text{Input\_filter}}$
	Controller + 11 expansion modules	22.5...48.1	+ $T_{\text{Input\_filter}}$
	Controller + 12 expansion modules	23.6...50.3	+ $T_{\text{Input\_filter}}$
	Controller + 13 expansion modules	24.7...52.5	+ $T_{\text{Input\_filter}}$
Controller + 14 expansion modules	25.8...54.6	+ $T_{\text{Input\_filter}}$	

Module-specific characteristics	XPSMCMEN020 0/ XPSMCMEN020 0G	XPSMCMEN0100HT • XPSMCMEN0200HT •	XPSMCMEN0100S C• XPSMCMEN0200S C•	XPSMCMEN0100T T• XPSMCMEN0200T T•
Encoder interface	none	HTL	Sin/Cos	TTL
Encoder input signals electrically insulated in accordance with EN 61800-1	none	<ul style="list-style-type: none"> <li>● Rated insulation voltage 250 V</li> <li>● Overvoltage category II</li> <li>● Rated impulse withstand voltage 4.00 kV</li> </ul>		
Max. number of axis	2			
Zero speed / maximum speed frequency gap	> 10 Hz			
Minimum gap between thresholds (with threshold >1)	> 5 %			
Max. number of encoders	0	1 on XPSMCMEN0100TT•, XPSMCMEN0100HT•, XPSMCMEN0100SC• 2 on XPSMCMEN0200TT•, XPSMCMEN0200HT•, XPSMCMEN0200SC•		
Max. encoder frequency	-	300 kHz	500 kHz	500 kHz

<b>Module-specific characteristics</b>	<b>XPSMCMEN020 0/ XPSMCMEN020 0G</b>	<b>XPSMCMEN0100HT • XPSMCMEN0200HT •</b>	<b>XPSMCMEN0100S C• XPSMCMEN0200S C•</b>	<b>XPSMCMEN0100T T• XPSMCMEN0200T T•</b>
Encoder adjustable threshold range	–	1 Hz to 450 kHz		
Encoder connections	-	RJ45		
Max. number of proximity sensors	2			
Max. proximity sensors frequency	5 kHz			
Maximum output current to proximity sensor	100 mA at 24 Vdc (terminals 5 and 9)			
Proximity adjustable threshold range	1 Hz to 4 kHz			
Zero speed/Maximum speed frequency gap	>10 Hz			
Minimum gap between thresholds (with threshold >1)	>5 %			
Proximity sensors connections	Terminal blocks			
Proximity sensors type	PNP/NPN - 3/4 wires			
PFHd XPSMCMEN01•	–	6.70-09	7.94E-09	7.08E-09
PFHd XPSMCMEN02•	5.98E-09	7.42-09	9.89E-09	8.18E-09
MeanTime to Dangerous Failure (MTTFd) in years XPSMCMEN0200	424			
MeanTime to Dangerous Failure (MTTFd) in years XPSMCMEN0100H T•, XPSMCMEN0100S C•, XPSMCMEN0100T T•	247			



Module-specific characteristics	XPSMCMEN020 0/ XPSMCMEN020 0G	XPSMCMEN0100HT • XPSMCMEN0200HT •	XPSMCMEN0100S C• XPSMCMEN0200S C•	XPSMCMEN0100T T• XPSMCMEN0200T T•
MeanTime to Dangerous Failure (MTTFd) in years XPSMCMEN0200HT T•, XPSMCMEN0200S C•, XPSMCMEN0200T T•	180			
Weight	0.12 kg (4.2 Oz)			

### Checklist After Installation

The following must be verified:

Step	Action
1	Conduct a full functional test of the system (see <i>Validation</i> in the <i>Modular Safety Controller User Guide</i> .)
2	Verify that all the cables are correctly inserted and the terminal blocks are within correct torque for screw terminals.
3	Verify that all the LED indicators are correctly illuminating for the inputs and outputs used.
4	Verify the positioning and function of all input and output sensors and actuators used with the XPSMCM•.
5	Verify the correct mounting of XPSMCM• to the DIN rail.
6	Verify that all the external indicators (lamps/beacons/sirens) are correctly functioning.

**EC Declaration of Conformity**



**EC DECLARATION OF CONFORMITY**

Copy of Document-no.: EAV9139101.00  
Original Language

WE: **Schneider Electric Automation GmbH** / Schneiderplatz 1 / Marktheidenfeld 97828, Germany  
*hereby declare that the safety component*

TRADEMARK: **SCHNEIDER ELECTRIC**

PRODUCT, TYPE: Modular Safety Controller

MODELS: XPSMCMCO0000S1\*, XPSMCMCO0000S2\*, XPSMCMCP0802\*, XPSMCMDI0800\*, XPSMCMDI1200MT\*, XPSMCMDI1600\*, XPSMCMDO0002\*, XPSMCMDO0004\*, XPSMCMEN0100HT\*, XPSMCMEN0100SC\*, XPSMCMEN0100TT\*, XPSMCMEN0200HT\*, XPSMCMEN0200SC\*, XPSMCMEN0200TT\*, XPSMCMER0002\*, XPSMCMER0004\*, XPSMCMMX0802\*, XPSMCMRO0004DA\*, XPSMCMRO0004\*, XPSMCMEN0200\*, XPSMCMME0000

SERIAL NUMBER: YYXXZZZZ (YY: 10...99, XX: 01...53, ZZZZ: 0001...9999)

DATE OF MANUFACTURING: refer to device nameplate

*all the essential protection requirements that are described in the following directives are defined, corresponding. Furthermore, the conformity with the following harmonized European standards explained:*

DIRECTIVE:	HARMONIZED STANDARD:
<b>DIRECTIVE 2006/42/EC OF THE EUROPEAN PARLIAMENT AND OF THE COUNCIL</b> of 17 May 2006 on machinery, and amending Directive 95/16/EC (recast)	EN 62061:2005 EN ISO 13849-1:2008 EN 61496-1:2013
<b>DIRECTIVE 2004/108/EC OF THE EUROPEAN PARLIAMENT AND OF THE COUNCIL (EMC)</b> of 15 December 2004 on the approximation of the laws of the Member States relating to electromagnetic compatibility and repealing Directive 89/336/EEC	EN 61131-2:2007
<b>DIRECTIVE 2011/65/EC OF THE EUROPEAN PARLIAMENT AND OF THE COUNCIL (RoHS)</b> of 8 June 2011 on the restriction of the use of certain hazardous substances in electrical and electronic equipment	EN 50581:2012

*It is important that the safety component is subject to correct installation, maintenance and use conforming to its intended purpose, to the applicable regulations and standards, to the supplier's instructions and to accepted rules of the art.*

Name and address of the person authorised to compile the technical file:  
Michael Schweizer / Schneider Electric Automation GmbH / Schneiderplatz 1 / Marktheidenfeld 97828, Germany  
First year of affixing CE marking: 2014

Marktheidenfeld, Germany  
December 1st, 2014

i.A. Michael Schweizer  
Machine Solutions Certification Manager

The original EC Declaration of Conformity is available on our website: [www.schneider-electric.com](http://www.schneider-electric.com)