

Main

Range of product	Preventa Safety detection
Product or component type	Safety light curtain type 4
Device short name	XUSL4E
Output type	2 safety outputs OSSD solid-state PNP (arc suppression)
Product specific application	For hand protection
[R] Resolution	1.18 in (30 mm)
[Sn] nominal sensing distance	0...12 M by cabling 0...4 m by cabling
[Hp] Height protected	24.02 in (610 mm)
Number of beams	31
Type of start / restart	Automatic Manual
External Device Monitoring (EDM)	Selected by wiring

Complementary

Detection system	Transmitter-receiver system
Kit composition	Adjustable mounting bracket(s) 1 receiver(s) 1 transmitter(s) 1 user guide with certificate of conformity on CD-ROM
[EAA] effective aperture angle	2.5 ° at 3 m
Emission	IR LED 950 nm
[Us] rated supply voltage	24 V DC +/- 20 %
Supply	Power supply conforming to IEC 61496-1 Power supply conforming to IEC 60204-1
[Ie] rated operational current	2 A
Current consumption	42 mA no-load transmitter 83 mA no-load receiver 42 mA transmitter 900 mA with maximum load receiver
Output current limits	0.4 A for safety outputs OSSD
Output voltage	24 V
Output circuit type	DC
Maximum voltage drop	<0.5 V
Local signalling	1 multi-colour LED transmitter 2 dual colour LEDs receiver
Electrical connection	1 male connector M12 5 pins transmitter 1 male connector M12 8 pins receiver
Function available	Test Muting through external safety module XPSLCMUT1160 LED display of operating modes and faults
Marking	CE
Material	Aluminium casing Polycarbonate: front panel Polypropylene: end caps
Housing colour	Red RAL 3000
Fixing mode	By fixing brackets
Net Weight	2.69 lb(US) (1.22 kg)

Offer type	Standard distance
Topology	Daisy chain slave2

Environment

Directives	98/37/EEC - machinery 89/336/EEC - electromagnetic compatibility 89/655/EEC - work equipment 2002/96/EC - WEEE directive 2002/95/EC - RoHS directive
Product certifications	CE TÜV CULus
Safety level (correctly wired)	Type 4 conforming to IEC 61496-1 SIL 3 conforming to IEC 61508 SILCL 3 conforming to IEC 62061 Category 4 conforming to EN/ISO 13849-1 PL = e conforming to EN/ISO 13849-1
Optical characteristic	Resistance to light disturbance conforming to EN/IEC 61496-2
Mission time	20 year(s)
Safety reliability data	PFHd = 1.06E-8 1/h IEC 61508
Ambient air temperature for operation	-22...131 °F (-30...55 °C) 14...131 °F (-10...55 °C)
Ambient air temperature for storage	-31...158 °F (-35...70 °C) -13...158 °F (-25...70 °C)
Relative humidity	0...95 % without condensation
IP degree of protection	IP65 IP67
Shock resistance	10 gn 16 ms IEC 61496-1
Vibration resistance	0.35 +/- 0.05 mm 10...55 Hz)IEC 61496-1



Ordering and shipping details

Category	22455 - LIGHT CURTAINS - XUSL
Discount Schedule	DS2
GTIN	03389119620161
Nbr. of units in pkg.	1
Package weight(Lbs)	5.33 lb(US) (2.42 kg)
Returnability	No
Country of origin	IT

Packing Units

Unit Type of Package 1	PCE
Package 1 Height	5.31 in (13.5 cm)
Package 1 width	7.68 in (19.5 cm)
Package 1 Length	27.56 in (70 cm)

Offer Sustainability

Sustainable offer status	Green Premium product
California proposition 65	WARNING: This product can expose you to chemicals including: Diisononyl phthalate (DINP), which is known to the State of California to cause cancer, and Di-isodecyl phthalate (DIDP), which is known to the State of California to cause birth defects or other reproductive harm. For more information go to www.P65Warnings.ca.gov
REACH free of SVHC	Yes
EU RoHS Directive	Pro-active compliance (Product out of EU RoHS legal scope)  EU RoHS Declaration
Toxic heavy metal free	Yes
Mercury free	Yes
RoHS exemption information	 Yes

Environmental Disclosure	Product Environmental Profile
Circularity Profile	End Of Life Information

Contractual warranty

Warranty	18 months
----------	-----------

Dimensions

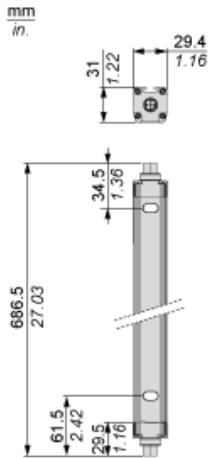

Brackets Dimensions

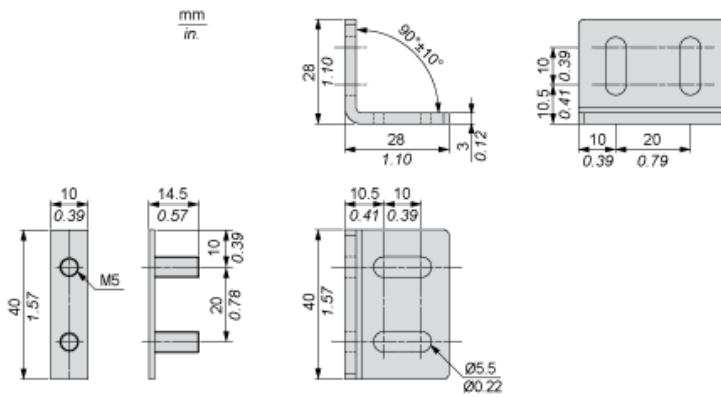

Mounting and Clearance



- (1) Insert
- (2) Bracket
- (3) Washer
- (4) Spring washer
- (5) Nut

Wiring Diagrams

Transmitter Connections

Slave primary connector at the bottom

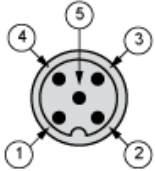

- (1) +24 Vdc
- (2) Master/Slave_A
- (3) 0 Vdc
- (4) Master/Slave_B
- (5) FE

Slave secondary connector at the top

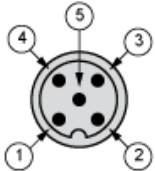

- (1) +24 Vdc
- (2) Master/Slave_A
- (3) 0 Vdc
- (4) Master/Slave_B
- (5) FE

Receiver Connections

Slave primary connector at the bottom

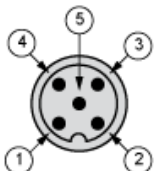

- (1) +24 Vdc
- (2) Master/Slave_A
- (3) 0 Vdc
- (4) Master/Slave_B
- (5) FE

Slave secondary connector at the top

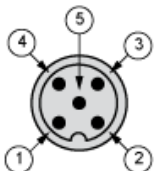

- (1) +24 Vdc
- (2) Master/Slave_A
- (3) 0 Vdc
- (4) Master/Slave_B
- (5) FE