



## Main

Range of product	Zelio Time
Product or component type	Modular timing relay
Discrete output type	Relay
Maximum Width	0.69 in (17.5 mm)
Device short name	RE17R
Time delay type	A Ht H Di At D B C
Time delay range	6...60 min 1...10 min 1...10 s 1...10 h 6...60 s 0.1...1 s
Nominal output current	8 A

## Complementary

Contacts type and composition	1 C/O
Contacts material	Cadmium free
Height	3.54 in (90 mm)
Depth	2.83 in (72 mm)
Control type	Selector switch front panel
[Us] rated supply voltage	24...240 V AC 50/60 Hz 24 V DC
Voltage range	0.85...1.1 Us
Supply frequency	50...60 Hz +/- 5 %
Release of input voltage	10 V
Connections - terminals	Screw terminals, 1 x 0.5...1 x 3.3 mm <sup>2</sup> AWG 20...AWG 12) solid without cable end Screw terminals, 2 x 0.5...2 x 2.5 mm <sup>2</sup> AWG 20...AWG 14) solid without cable end Screw terminals, 1 x 0.2...1 x 2.5 mm <sup>2</sup> AWG 24...AWG 14) flexible with cable end Screw terminals, 2 x 0.2...2 x 1.5 mm <sup>2</sup> AWG 24...AWG 16) flexible with cable end
Tightening torque	5.31...8.85 lbf.in (0.6...1 N.m) IEC 60947-1
Housing material	Self-extinguishing
Repeat accuracy	+/- 0.5 % IEC 61812-1
Temperature drift	+/- 0.05 %/°C
Voltage drift	+/- 0.2 %/V
Setting accuracy of time delay	+/- 10 % of full scale 25 °C IEC 61812-1
Control signal pulse width	100 ms with load in parallel typical 30 ms typical
Insulation resistance	100 MOhm 500 V DC IEC 60664-1
Reset time	120 ms on de-energisation typical
On-load factor	100 %
Power consumption in VA	0...32 VA 240 V AC
Maximum power consumption in W	0.6 W 24 V DC

The information provided in this documentation contains general descriptions and/or technical characteristics of the performance of the products contained herein. This documentation is not intended as a substitute for and is not to be used for determining suitability or reliability of these products for specific user applications. It is the duty of any such user or integrator to perform the appropriate and complete risk analysis, evaluation and testing of the products with respect to the relevant specific application or use thereof. Neither Schneider Electric Industries SAS nor any of its affiliates or subsidiaries shall be responsible or liable for misuse of the information contained herein.

Minimum switching current	10 mA 5 V DC
Maximum switching current	8 A AC/DC
Maximum switching voltage	250 V AC
Breaking capacity	2000 VA
Operating frequency	10 Hz
Electrical durability	100000 cycles resistive 8 A 250 V AC
Mechanical durability	10000000 cycles
Dielectric strength	2.5 kV 1 mA/1 minute 50 Hz IEC 61812-1
[Uimp] rated impulse withstand voltage	5 kV 1.2/50 $\mu$ s
Power on delay	100 ms
Marking	CE
Creepage distance	4 kV/3 IEC 60664-1
Safety reliability data	MTTFd = 296.8 years B10d = 270000
Mounting position	Any position in relation to normal vertical mounting plane
Mounting support	35 mm DIN rail EN/IEC 60715
Local signalling	LED indicator on steady: relay energised, no timing in progress LED indicator 80 % ON and 20 % OFF flashing: timing in progress LED indicator 5 % ON and 95 % OFF pulsing: relay de-energised, no timing in progress (except function Di-D, Li-L)
Net Weight	0.15 lb(US) (0.07 kg)
Time delay type	A, At, B, C, D, Di, H, Ht
Functionality	Multifunction
Compatibility code	RE17

## Environment

Immunity to microbreaks	20 ms
Standards	2004/108/EC EN 61000-6-2 EN 61000-6-3 EN 61000-6-1 2006/95/EC IEC 61812-1 EN 61000-6-4
Product certifications	CSA CULus
Ambient air temperature for storage	-22...140 °F (-30...60 °C)
Ambient air temperature for operation	-4...140 °F (-20...60 °C)
IP degree of protection	IP20 IEC 60529 terminal block) IP40 IEC 60529 housing) IP50 IEC 60529 front panel)
Vibration resistance	20 m/s <sup>2</sup> 10...150 Hz)IEC 60068-2-6
Shock resistance	15 gn 11 ms IEC 60068-2-27
Relative humidity	93 % without condensation IEC 60068-2-30
Electromagnetic compatibility	Electrostatic discharge immunity test 6 kV in contact) level 3 IEC 61000-4-2 Electrostatic discharge immunity test 8 kV in air) level 3 IEC 61000-4-2 Susceptibility to electromagnetic fields 10 V/m 80 MHz to 1 GHz) level 3 IEC 61000-4-3 Electrical fast transient/burst immunity test 1 kV capacitive connecting clip) level 3 IEC 61000-4-4 Electrical fast transient/burst immunity test 2 kV direct) level 3 IEC 61000-4-4 1.2/50 $\mu$ s shock waves immunity test 1 kV differential mode) level 3 IEC 61000-4-5 1.2/50 $\mu$ s shock waves immunity test 2 kV common mode) level 3 IEC 61000-4-5 Conducted RF disturbances 10 V 0.15...80 MHz) level 3 IEC 61000-4-6 Voltage dips and interruptions immunity test 0 % 1 cycle) IEC 61000-4-11 Voltage dips and interruptions immunity test 70 % 25/30 cycles) IEC 61000-4-11 Conducted and radiated emissionsclass B EN 55022

## Ordering and shipping details

Category	22370 - RE, RM MISC TIMERS & COUNTERS
Discount Schedule	CP2
GTIN	00785901474357
Nbr. of units in pkg.	1
Package weight(Lbs)	0.17 lb(US) (0.08 kg)
Returnability	Yes
Country of origin	ID

## Packing Units

Unit Type of Package 1	PCE
Package 1 Height	1.10 in (2.8 cm)
Package 1 width	3.07 in (7.8 cm)
Package 1 Length	3.78 in (9.6 cm)
Unit Type of Package 2	S02
Number of Units in Package 2	40
Package 2 Weight	8.25 lb(US) (3.74 kg)
Package 2 Height	5.91 in (15 cm)
Package 2 width	11.81 in (30 cm)
Package 2 Length	15.75 in (40 cm)

## Offer Sustainability

Sustainable offer status	Green Premium product
California proposition 65	WARNING: This product can expose you to chemicals including: Lead and lead compounds, which is known to the State of California to cause cancer and birth defects or other reproductive harm. For more information go to <a href="http://www.P65Warnings.ca.gov">www.P65Warnings.ca.gov</a>
REACH Regulation	<a href="#">REACH Declaration</a>
EU RoHS Directive	Pro-active compliance (Product out of EU RoHS legal scope) <a href="#">EU RoHS Declaration</a>
Mercury free	Yes
RoHS exemption information	<a href="#">Yes</a>
China RoHS Regulation	<a href="#">China RoHS Declaration</a>
Environmental Disclosure	<a href="#">Product Environmental Profile</a>
Circularity Profile	<a href="#">End Of Life Information</a>

Width 17.5 mm

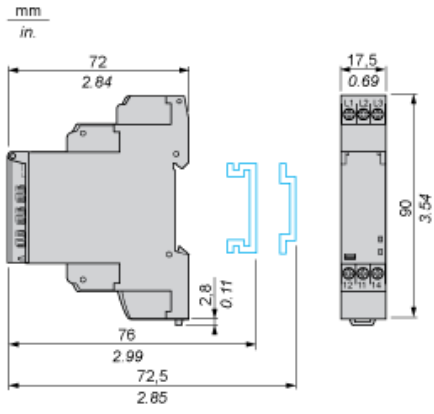

Internal Wiring Diagram

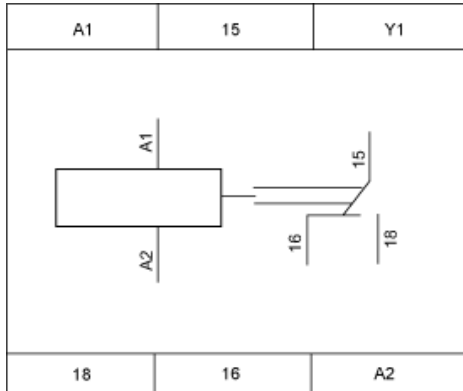

Wiring Diagram

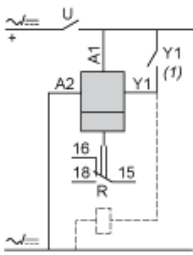

1) Contact Y1:

- Control for functions B, C, Ac, Bw, Ad, Ah, N, O, W, T, Tt.
- Partial stop for functions At, Ht and Pt.
- Function D if Di selected.
- Not used for functions A, H and P.

Function A : Power on Delay Relay

Description

The timing period T begins on energisation. After timing, the output(s) R close(s). The second output can be either timed or instantaneous.

Function: 1 Output



Function: 2 Outputs

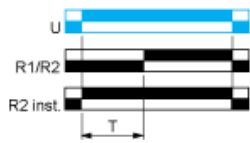

2 timed outputs (R1/R2) or 1 timed output (R1) and 1 instantaneous output (R2 inst.)

Function At : Power on Delay Relay (Summation) with Control Signal

Description

After power-up, the first opening of control contact C starts the timing. Timing can be interrupted each time control contact closes. When the cumulative total of time periods elapsed reaches the pre-set value T, the output relay closes.

Function: 1 Output

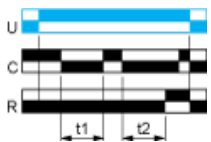

$T = t_1 + t_2 + \dots$

Function B : Interval Relay with Control Signal

Description

After power-up, pulsing or maintaining control contact C starts the timing T. The output R closes for the duration of the timing period T then reverts to its initial state.

Function: 1 Output

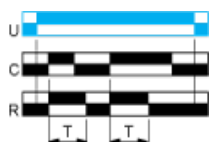

Function C : Off-Delay Relay with Control Signal

Description

After power-up and closing of the control contact C, the output R closes. When control contact C re-opens, timing T starts. At the end of the timing period, the output(s) R revert(s) to its/their initial state. The second output can be either timed or instantaneous.

### Function: 1 Output



### Function: 2 Outputs

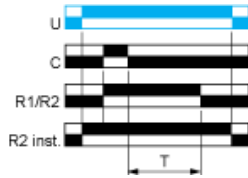

2 timed outputs (R1/R2) or 1 timed output (R1) and 1 instantaneous output (R2 inst.)

## Function D: Symmetrical Flashing Relay (Starting Pulse Off)

### Description

On energisation of power supply, output(s) R starts at its/their initial state for timing duration T then change(s) to output(s) R close(s) for the same timing duration T. This cycle is repeated indefinitely until power supply removal. Specially for RE17\*, RE22R2AMU, RE22R2MMW, RE22R2MMU, RE22R2MJU, this D function can only be initiated by energizing Y1 permanently. The second output (R2) can be either timed (when set to "TIMED") or instantaneous (when set to "INST").

### Function: 1 Output



### Function: 2 Outputs

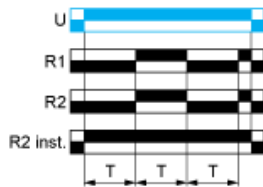

### Function: 1 Output with Retrigger / Restart Control

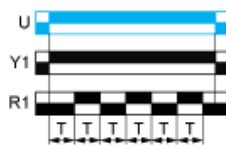

### Function: 2 Output with Retrigger / Restart Control

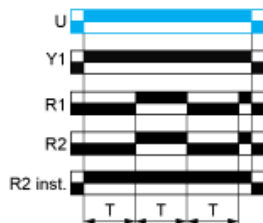

## Function Di : Symmetrical Flasher Relay (Starting Pulse On)

### Description

Repetitive cycle with two timing periods T of equal duration, with output(s) R changing state at the end of each timing period T. The second output can be either timed or instantaneous.

### Function: 1 Output



### Function: 2 Outputs

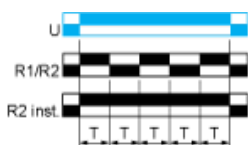

2 timed outputs (R1/R2) or 1 timed output (R1) and 1 instantaneous output (R2 inst.)

## Function H : Interval Relay

---

### Description

On energisation of the relay, timing period T starts and the output(s) R close(s). At the end of the timing period T, the output(s) R revert(s) to its/their initial state. The second output can be either timed or instantaneous.

### Function: 1 Output



### Function: 2 Outputs

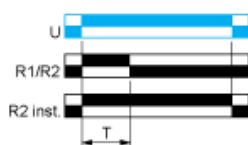

2 timed outputs (R1/R2) or 1 timed output (R1) and 1 instantaneous output (R2 inst.)

## Function Ht: Interval Relay & With Pause / Summation Control

---

### Description

On energisation of power supply, output(s) R close(s) and timing period T starts.

The timing can be interrupted / paused each time X1 energizes.

When the cumulative total of time periods elapsed reaches the pre-set value T, the output(s) R revert(s) to its/their initial state. Reenergization of X1 will also cause output(s) R close(s) if the time has elapsed and restart the same operation as described at the beginning.

Except for RE17\*, RE22R2MMW, RENF22R2MMW, RE22R2MMU and RE22R2MJU, timing can be interrupted / paused each time Y1 energizes.

The second output (R2) can be either timed (when set to "TIMED" or instantaneous (when set to "INST").

### Function: 1 Output

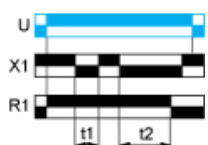

$$T = t1 + t2 + \dots$$

### Function: 2 Outputs

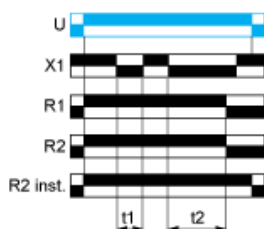

$$T = t1 + t2 + \dots$$



### Function: 1 Output with Retrigger / Restart Control

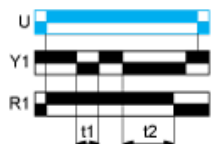

$T = t1 + t2 + \dots$

### Function: 2 Outputs with Retrigger / Restart Control

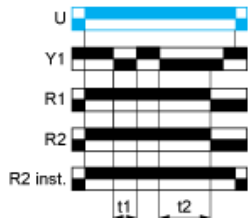

$T = t1 + t2 + \dots$

### Legend

- Relay de-energised
- Relay energised
- Output open
- Output closed
- C Control contact
- G Gate
- R Relay or solid state output
- R1/ R2 2 timed outputs
- R2 inst. The second output is instantaneous if the right position is selected
- T Timing period
- Ta Adjustable On-delay
- 
- Tr Adjustable Off-delay
- 
- U Supply