

Altivar Machine ATV340

Variable Speed Drives

Safety functions Manual (with Module VW3A3802)

06/2020



The information provided in this documentation contains general descriptions and/or technical characteristics of the performance of the products contained herein. This documentation is not intended as a substitute for and is not to be used for determining suitability or reliability of these products for specific user applications. It is the duty of any such user or integrator to perform the appropriate and complete risk analysis, evaluation and testing of the products with respect to the relevant specific application or use thereof. Neither Schneider Electric nor any of its affiliates or subsidiaries shall be responsible or liable for misuse of the information contained herein. If you have any suggestions for improvements or amendments or have found errors in this publication, please notify us.

You agree not to reproduce, other than for your own personal, noncommercial use, all or part of this document on any medium whatsoever without permission of Schneider Electric, given in writing. You also agree not to establish any hypertext links to this document or its content. Schneider Electric does not grant any right or license for the personal and noncommercial use of the document or its content, except for a non-exclusive license to consult it on an "as is" basis, at your own risk. All other rights are reserved.

All pertinent state, regional, and local safety regulations must be observed when installing and using this product. For reasons of safety and to help ensure compliance with documented system data, only the manufacturer should perform repairs to components.

When devices are used for applications with technical safety requirements, the relevant instructions must be followed.

Failure to use Schneider Electric software or approved software with our hardware products may result in injury, harm, or improper operating results.

Failure to observe this information can result in injury or equipment damage.

© 2020 Schneider Electric. All rights reserved.

Table of Contents



	Safety Information	5
	About the Book	11
Chapter 1	General System Description	15
	Introduction	16
	Accessories	19
	Certifications	20
	Basics	21
	Safety Function Capability	24
Chapter 2	Technical Data	27
2.1	Safety Module	28
	Electrical Data	29
	Installation of the Safety Module	31
	Electrical Installation	32
	Pin Layout of the Safety Module	35
2.2	Terminal Adapter (VW3M8810)	36
	Installation of Terminal Adapter	37
	Electrical Installation	38
	Pin Layout of Terminal Adapter	40
2.3	Wiring for Multi-Axis System	42
	Overview	43
	Wiring with Terminal Adapter	45
Chapter 3	Safety Functions	47
	Safety Function STO (Safe Torque Off) with The Safety Module	48
	Safety Function SS1 (Safe Stop 1)	49
	Safety Function SLS (Safely Limited Speed)	53
	Safety Function SBC (Safe Brake Control)	64
	Safety Function SMS (Safe Maximum Speed)	69
	Safety Function GDL (Guard Door Locking)	74
Chapter 4	Additional Features	77
	Safety Module Start Signal	78
	Output SQ1 function	80
	Output Status SQ2 Function	82
Chapter 5	Behavior of Safety Functions	83
	Limitations	84
	Priority Between Safety Functions	86
	Compatibility and Precedence of Safety Functions and Non-Safety-Related Functions	87
Chapter 6	Commissioning and Display	91
	Prerequisites to Configure The Safety Module	92
	Configuration with The Commissioning Software	93
	Acceptance Test and Machine Signature	99
	Additional Features for The Commissioning	100
	Copying Safety-related Configuration	103
	Display	106
	Dedicated Safety Function menu in the Display Terminal	107
Chapter 7	Diagnostics and Troubleshooting	113
	Monitoring Functions	114
	Operating States and State Transitions	115
	Detected Errors	117
	FAQ	123



Important Information

NOTICE

Read these instructions carefully, and look at the equipment to become familiar with the device before trying to install, operate, service, or maintain it. The following special messages may appear throughout this documentation or on the equipment to warn of potential hazards or to call attention to information that clarifies or simplifies a procedure.



The addition of this symbol to a “Danger” or “Warning” safety label indicates that an electrical hazard exists which will result in personal injury if the instructions are not followed.



This is the safety alert symbol. It is used to alert you to potential personal injury hazards. Obey all safety messages that follow this symbol to avoid possible injury or death.

DANGER

DANGER indicates a hazardous situation which, if not avoided, **will result in** death or serious injury.

WARNING

WARNING indicates a hazardous situation which, if not avoided, **could result in** death or serious injury.

CAUTION

CAUTION indicates a hazardous situation which, if not avoided, **could result in** minor or moderate injury.

NOTICE

NOTICE is used to address practices not related to physical injury.

PLEASE NOTE

Electrical equipment should be installed, operated, serviced, and maintained only by qualified personnel. No responsibility is assumed by Schneider Electric for any consequences arising out of the use of this material.

A qualified person is one who has skills and knowledge related to the construction and operation of electrical equipment and its installation, and has received safety training to recognize and avoid the hazards involved.

Qualification Of Personnel

Only appropriately trained persons who are familiar with and understand the contents of this manual and all other pertinent product documentation are authorized to work on and with this product. In addition, these persons must have received safety training to recognize and avoid hazards involved. These persons must have sufficient technical training, knowledge and experience and be able to foresee and detect potential hazards that may be caused by using the product, by changing the settings and by the mechanical, electrical and electronic equipment of the entire system in which the product is used. All persons working on and with the product must be fully familiar with all applicable standards, directives, and accident prevention regulations when performing such work.

Intended Use

The product described or affected by this manual is, along with software, accessories and options, drive systems for three-phase synchronous, asynchronous motors and intended for industrial use.

The product may only be used in compliance with all applicable safety standard and local regulations and directives, the specified requirements and the technical data. The product must be installed outside the hazardous ATEX zone. Prior to using the product, you must perform a risk assessment in view of the planned application. Based on the results, the appropriate safety measures must be implemented. Since the product is used as a component in an entire system, you must ensure the safety of persons by means of the design of this entire system (for example, machine design). Any use other than the use explicitly permitted is prohibited and can result in hazards.

Product Related Information

Read and understand these instructions before performing any procedure with this drive.

 **DANGER**

HAZARD OF ELECTRIC SHOCK, EXPLOSION OR ARC FLASH

- Only appropriately trained persons who are familiar with and understand the contents of this manual and all other pertinent product documentation and who have received safety training to recognize and avoid hazards involved are authorized to work on and with this drive system. Installation, adjustment, repair and maintenance must be performed by qualified personnel.
- The system integrator is responsible for compliance with all local and national electrical code requirements as well as all other applicable regulations with respect to grounding of all equipment.
- Many components of the product, including the printed circuit boards, operate with mains voltage.
- Only use properly rated, electrically insulated tools and measuring equipment.
- Do not touch unshielded components or terminals with voltage present.
- Motors can generate voltage when the shaft is rotated. Prior to performing any type of work on the drive system, block the motor shaft to prevent rotation.
- AC voltage can couple voltage to unused conductors in the motor cable. Insulate both ends of unused conductors of the motor cable.
- Do not short across the DC bus terminals or the DC bus capacitors or the braking resistor terminals.
- Before performing work on the drive system:
 - Disconnect all power, including external control power that may be present. Take into account that the circuit breaker or main switch does not de-energize all circuits.
 - Place a **Do Not Turn On** label on all power switches related to the drive system.
 - Lock all power switches in the open position.
 - Wait 15 minutes to allow the DC bus capacitors to discharge.
 - Follow the instructions given in the chapter "Verifying the Absence of Voltage" in the installation manual of the product.
- Before applying voltage to the drive system:
 - Verify that the work has been completed and that the entire installation cannot cause hazards.
 - If the mains input terminals and the motor output terminals have been grounded and short-circuited, remove the ground and the short circuits on the mains input terminals and the motor output terminals.
 - Verify proper grounding of all equipment.
 - Verify that all protective equipment such as covers, doors, grids is installed and/or closed.

Failure to follow these instructions will result in death or serious injury.

Damaged products or accessories may cause electric shock or unanticipated equipment operation.

 **DANGER**

ELECTRIC SHOCK OR UNANTICIPATED EQUIPMENT OPERATION

Do not use damaged products or accessories.

Failure to follow these instructions will result in death or serious injury.

Contact your local Schneider Electric sales office if you detect any damage whatsoever.

This equipment has been designed to operate outside of any hazardous location. Only install this equipment in zones known to be free of a hazardous atmosphere.

DANGER

POTENTIAL FOR EXPLOSION

Install and use this equipment in non-hazardous locations only.

Failure to follow these instructions will result in death or serious injury.

Your application consists of a whole range of different interrelated mechanical, electrical, and electronic components, the drive being just one part of the application. The drive by itself is neither intended to nor capable of providing the entire functionality to meet all safety-related requirements that apply to your application. Depending on the application and the corresponding risk assessment to be conducted by you, a whole variety of additional equipment is required such as, but not limited to, external encoders, external brakes, external monitoring devices, guards, etc.

As a designer/manufacture of machines, you must be familiar with and observe all standards that apply to your machine. You must conduct a risk assessment and determine the appropriate Performance Level (PL) and/or Safety Integrity Level (SIL) and design and build your machine in compliance with all applicable standards. In doing so, you must consider the interrelation of all components of the machine. In addition, you must provide instructions for use that enable the user of your machine to perform any type of work on and with the machine such as operation and maintenance in a safe manner.

The present document assumes that you are fully aware of all normative standards and requirements that apply to your application. Since the drive cannot provide all safety-related functionality for your entire application, you must ensure that the required Performance Level and/or Safety Integrity Level is reached by installing all necessary additional equipment.

WARNING

INSUFFICIENT PERFORMANCE LEVEL/SAFETY INTEGRITY LEVEL AND/OR UNINTENDED EQUIPMENT OPERATION

- Conduct a risk assessment according to EN ISO 12100 and all other standards that apply to your application.
- Use redundant components and/or control paths for all critical control functions identified in your risk assessment.
- If moving loads can result in hazards, for example, slipping or falling loads, operate the drive in closed loop mode.
- Verify that the service life of all individual components used in your application is sufficient for the intended service life of your overall application.
- Perform extensive commissioning tests for all potential error situations to verify the effectiveness of the safety-related functions and monitoring functions implemented, for example, but not limited to, speed monitoring by means of encoders, short circuit monitoring for all connected equipment, correct operation of brakes and guards.
- Perform extensive commissioning tests for all potential error situations to verify that the load can be brought to a safe stop under all conditions.

Failure to follow these instructions can result in death, serious injury, or equipment damage.

A specific application note [NHA80973](#) is available on hoisting machines and can be downloaded on [se.com](#).

Drive systems may perform unexpected movements because of incorrect wiring, incorrect settings, incorrect data or other errors.

WARNING

UNANTICIPATED EQUIPMENT OPERATION

- Carefully install the wiring in accordance with the EMC requirements.
- Do not operate the product with unknown or unsuitable settings or data.
- Perform a comprehensive commissioning test.

Failure to follow these instructions can result in death, serious injury, or equipment damage.

WARNING

LOSS OF CONTROL

- The designer of any control scheme must consider the potential failure modes of control paths and, for critical control functions, provide a means to achieve a safe state during and after a path failure. Examples of critical control functions are emergency stop, overtravel stop, power outage and restart.
- Separate or redundant control paths must be provided for critical control functions.
- System control paths may include communication links. Consideration must be given to the implications of unanticipated transmission delays or failures of the link.
- Observe all accident prevention regulations and local safety guidelines (1).
- Each implementation of the product must be individually and thoroughly tested for proper operation before being placed into service.

Failure to follow these instructions can result in death, serious injury, or equipment damage.

(1) For USA: Additional information, refer to NEMA ICS 1.1 (latest edition), Safety Guidelines for the Application, Installation, and Maintenance of Solid State Control and to NEMA ICS 7.1 (latest edition), Safety Standards for Construction and Guide for Selection, Installation and Operation of Adjustable-Speed Drive Systems.

The temperature of the products described in this manual may exceed 80 °C (176 °F) during operation.

WARNING

HOT SURFACES

- Ensure that any contact with hot surfaces is avoided.
- Do not allow flammable or heat-sensitive parts in the immediate vicinity of hot surfaces.
- Verify that the product has sufficiently cooled down before handling it.
- Verify that the heat dissipation is sufficient by performing a test run under maximum load conditions.

Failure to follow these instructions can result in death, serious injury, or equipment damage.

Machines, controllers, and related equipment are usually integrated into networks. Unauthorized persons and malware may gain access to the machine as well as to other devices on the network/fieldbus of the machine and connected networks via insufficiently secure access to software and networks.

 WARNING

UNAUTHORIZED ACCESS TO THE MACHINE VIA SOFTWARE AND NETWORKS

- In your hazard and risk analysis, consider all hazards that result from access to and operation on the network/fieldbus and develop an appropriate cyber security concept.
- Verify that the hardware infrastructure and the software infrastructure into which the machine is integrated as well as all organizational measures and rules covering access to this infrastructure consider the results of the hazard and risk analysis and are implemented according to best practices and standards covering IT security and cyber security (such as: ISO/IEC 27000 series, Common Criteria for Information Technology Security Evaluation, ISO/ IEC 15408, IEC 62351, ISA/IEC 62443, NIST Cybersecurity Framework, Information Security Forum - Standard of Good Practice for Information Security).
- Verify the effectiveness of your IT security and cyber security systems using appropriate, proven methods.

Failure to follow these instructions can result in death, serious injury, or equipment damage.

 WARNING

LOSS OF CONTROL

Perform a comprehensive commissioning test to verify that communication monitoring properly detects communication interruptions

Failure to follow these instructions can result in death, serious injury, or equipment damage.

NOTICE

DESTRUCTION DUE TO INCORRECT MAINS VOLTAGE

Before switching on and configuring the product, verify that it is approved for the mains voltage.

Failure to follow these instructions can result in equipment damage.

About the Book



At a Glance

Document Scope

The purpose of this document is to provide information about the safety module and supported safety function.

Validity Note

Original instructions and information given in this manual have been written in English (before optional translation).

This documentation is valid for the Altivar Machine ATV340 drives.

The technical characteristics of the devices described in the present document also appear online. To access the information online:

Step	Action
1	Go to the Schneider Electric home page www.schneider-electric.com .
2	In the Search box type the reference of a product or the name of a product range. <ul style="list-style-type: none">• Do not include blank spaces in the reference or product range.• To get information on grouping similar modules, use asterisks (*).
3	If you entered a reference, go to the Product Datasheets search results and click on the reference that interests you. If you entered the name of a product range, go to the Product Ranges search results and click on the product range that interests you.
4	If more than one reference appears in the Products search results, click on the reference that interests you.
5	Depending on the size of your screen, you may need to scroll down to see the datasheet.
6	To save or print a datasheet as a .pdf file, click Download XXX product datasheet .

The characteristics that are described in the present document should be the same as those characteristics that appear online. In line with our policy of constant improvement, we may revise content over time to improve clarity and accuracy. If you see a difference between the document and online information, use the online information as your reference.

Related Documents

Use your tablet or your PC to quickly access detailed and comprehensive information on all our products on www.schneider-electric.com.

The internet site provides the information you need for products and solutions:

- The whole catalog for detailed characteristics and selection guides,
- The CAD files to help design your installation, available in over 20 different file formats,
- All software and firmware to maintain your installation up to date,
- A large quantity of White Papers, Environment documents, Application solutions, Specifications... to gain a better understanding of our electrical systems and equipment or automation,
- And finally all the User Guides related to your drive, listed below:

(Other option manuals and Instruction sheets are available on www.schneider-electric.com)

Title of Documentation	Catalog Number
Digital Catalog for Industrial Automation	Digit-Cat
ATV340 Catalog	DIA2ED2160701EN (English), DIA2ED2160701FR (French)
ATV340 Getting Started - Video	FAQ FA367923 (English) 
ATV340 Getting Started	NVE37643 (English), NVE37642 (French), NVE37644 (German), NVE37646 (Spanish), NVE37647 (Italian), NVE37648 (Chinese), NVE37643PT (Portuguese), NVE37643TR (Turkish)
ATV340 Getting Started Annex (SCCR)	NVE37641 (English)
Wiring Diagrams for Frame Sizes S1, S2, S3	NVE97896 (English)
ATV340 Installation Manual	NVE61069 (English), NVE61071 (French), NVE61074 (German), NVE61075 (Spanish), NVE61078 (Italian), NVE61079 (Chinese), NVE61069PT (Portuguese), NVE61069TR (Turkish)
ATV340 Programming Manual	NVE61643 (English), NVE61644 (French), NVE61645 (German), NVE61647 (Spanish), NVE61648 (Italian), NVE61649 (Chinese), NVE61643PT (Portuguese), NVE61643TR (Turkish)
ATV340 Modbus manual (Embedded)	NVE61654 (English)
ATV340 Ethernet manual (Embedded)	NVE61653 (English)
ATV340 PROFIBUS DP manual (VW3A3607)	NVE61656 (English)
ATV340 DeviceNet manual (VW3A3609)	NVE61683 (English)
ATV340 PROFINET manual (VW3A3627)	NVE61678 (English)
ATV340 CANopen manual (VW3A3608, 618, 628)	NVE61655 (English)
ATV340 POWERLINK manual - (VW3A3619)	NVE61681 (English)
ATV340 EtherCAT manual - (VW3A3601)	NVE61686 (English)
ATV340 Sercos III manual (embedded)	PHA33735 (English), PHA33737 (French), PHA33738 (German), PHA33739 (Spanish), PHA33740 (Italian), PHA33741 (Chinese)
ATV340 Communication Parameters	NVE61728 (English)
ATV340 ATEX manual	NVE61651 (English)
ATV340 Embedded Safety Function Manual	NVE64143 (English)
ATV340 Safety functions Manual (with Module VW3A3802) Upcoming commercialization	NVE61741 (English), NVE61742 (French), NVE61745 (German), NVE61747 (Spanish), NVE61749 (Italian), NVE61752 (Chinese), NVE61741PT (Portuguese), NVE61741TR (Turkish)
SoMove FDT	SoMove_FDI (English, French, German, Spanish, Italian, Chinese)

Title of Documentation	Catalog Number
Altivar 340: DTM	ATV340 DTM Library EN (English), ATV340 DTM Lang FR (French), ATV340 DTM Lang DE (German), ATV340 DTM Lang SP (Spanish), ATV340 DTM Lang IT (Italian), ATV340 DTM Lang CN (Chinese)
Altivar Application Note for Hoisting	NHA80973 (English)
Recommended Cybersecurity Best Practices	CS-Best-Practices-2019-340 (English)

You can download these technical publications and other technical information from our website at www.schneider-electric.com/en/download

Terminology

The technical terms, terminology, and the corresponding descriptions in this manual normally use the terms or definitions in the relevant standards.

In the area of drive systems this includes, but is not limited to, terms such as **error**, **error message**, **failure**, **fault**, **fault reset**, **protection**, **safe state**, **safety function**, **warning**, **warning message**, and so on.

Among others, these standards include:

- IEC 61800 series: Adjustable speed electrical power drive systems
- IEC 61508 Ed.2 series: Functional safety of electrical/electronic/programmable electronic safety-related
- EN 954-1 Safety of machinery - safety-related parts of control systems
- ISO 13849-1 & 2 Safety of machinery - safety related parts of control systems
- IEC 61158 series: Industrial communication networks - Fieldbus specifications
- IEC 61784 series: Industrial communication networks - Profiles
- IEC 60204-1: Safety of machinery - Electrical equipment of machines – Part 1: General requirements

Contact Us

Select your country on:

www.schneider-electric.com/contact

Schneider Electric Industries SAS

Head Office

35, rue Joseph Monier

92500 Rueil-Malmaison

France

Chapter 1

General System Description

What Is in This Chapter?

This chapter contains the following topics:

Topic	Page
Introduction	16
Accessories	19
Certifications	20
Basics	21
Safety Function Capability	24

Introduction

Overview

WARNING

INEFFECTIVE SAFETY FUNCTIONS

- Verify that a risk assessment as per ISO 12100 and/or any other equivalent assessment has been performed before this product is used.
- Verify that only persons who are trained and certified experts in safety engineering and who are familiar with all safety-related standards, provisions, and regulations such as, but not limited to, IEC 61800-5-2 work with this product.
- Verify that only persons who are thoroughly familiar with the safety-related applications and the non-safety-related applications as well as the hardware used to operate the machine/process, work with this product.

Failure to follow these instructions can result in death, serious injury, or equipment damage.

WARNING

UNANTICIPATED EQUIPMENT OPERATION

- Only start the machine/process if there are no persons or obstructions in the zone of operation.
- Only make modifications of any type whatsoever, including, but not limited to, parameters, settings, configurations, hardware, if you fully understand all effects of such modifications.
- Verify that modifications do not compromise or reduce the Safety Integrity Level (SIL), Performance Level (PL) and/or any other safety-related requirements and capabilities defined for your machine/process.
- After modifications of any type whatsoever, restart the machine/process and verify the correct operation and effectiveness of all functions by performing comprehensive tests for all operating states, the defined safe state, and all potential error situations.
- If you have to commission or recommission the machine/process, perform a commissioning test pursuant to all regulations, standards, and process definitions applicable to your machine/process.
- Document all modifications in compliance with all regulations, standards, and process definitions applicable to your machine/process.

Failure to follow these instructions can result in death, serious injury, or equipment damage.

The safety functions supported by the safety module VW3A3802 are intended to maintain the safe condition or prevent hazardous conditions. In some cases, external safety-related systems (for example a mechanical brake) may be necessary to maintain the safe condition when electrical power is removed.

The configuration of the safety module can only be done via the commissioning software SoMove FDT and Altivar DTM.

The safety module is compliant with the software version V1.6IE80 of Altivar Machine ATV340 drives. If this requirement is not respected, an error is triggered by the drive.

The Altivar Machine ATV340 drives are compliant with the requirements of the standards in terms of implementation of safety functions.

The Safety Module, the Drive, the Motor and External Safety Devices

The Safe Torque Off (STO) is a standard function of the drive. The STO inputs of the drive cannot be used with the safety module (*see page 48*).

The safety module is an option of the drive. It is used to monitor the actions of the drives and to execute the safety functions.

The inputs and the outputs of the safety module are configurable in order to assign the safety functions suitable to your needs.

A request to activate or deactivate a safety function comes from external devices (such as push buttons, magnetic switches, and so on) or a safety PLC wired to the safety module. Consequently, the requests to activate a safety function can be done automatically (such as activation via sensors) or manually (such as activation via switches).

Asynchronous motors are compatible with the safety module in open and closed loop control. Permanent magnet synchronous motors are only compatible with the safety module in closed loop control. Other type of motors are not compatible with the safety module.

NOTE: The use of motors in parallel is incompatible with the safety module.

The safety functions supported by the safety module cannot be used with output frequency greater than 200 Hz. For additional information refer to the chapter Behavior of Safety Functions (*see page 83*).

For multi-axis system with several safety modules VW3A3802, a terminal adapter must be used (*see page 42*).

Example

On the figure below, examples of architecture with the safety module:

- With or without encoder (closed loop or open loop control),
- With or without terminal adapter (depending on the cable length or in case of multi-axis system)
- With or without safety PLC.

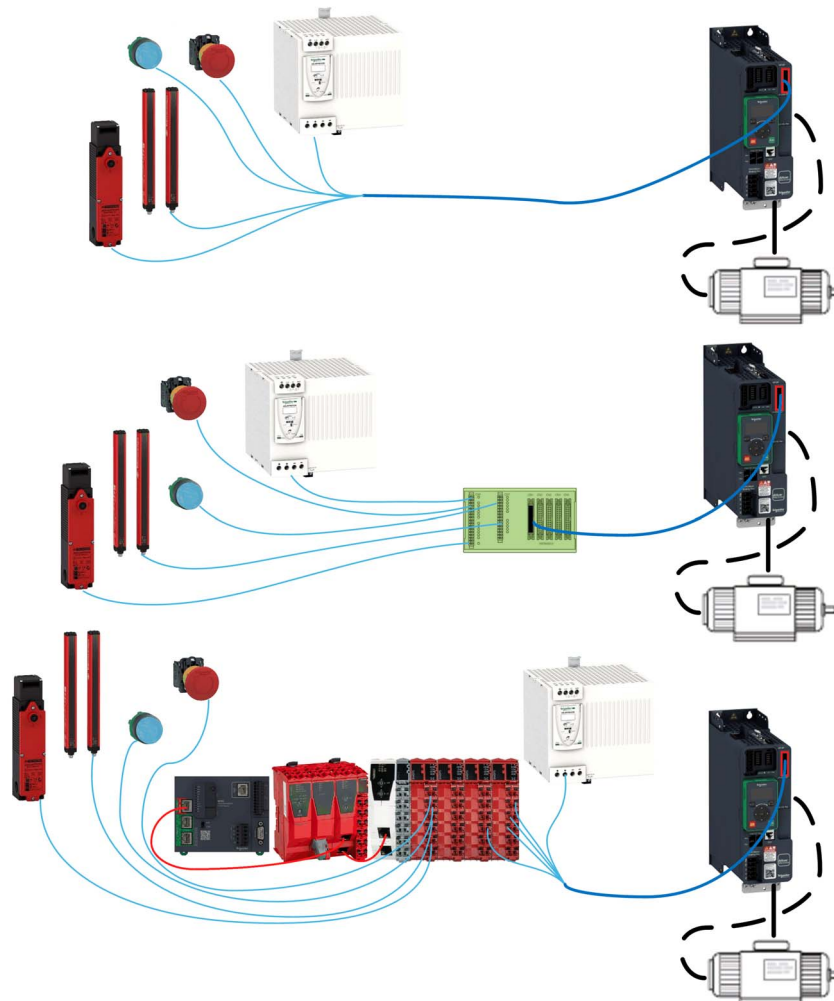

Supported Safety Functions as Defined by IEC 61800-5-2

Definitions

Acronym	Description
SLS	Safely-Limited Speed The safety function SLS prevents the motor from exceeding the specified speed limit. If the motor speed exceeds the specified speed limit value, safety function STO is triggered.
SS1	Safe Stop 1 <ul style="list-style-type: none"> ● Initiates and monitors the motor deceleration rate within set limits to stop the motor ● Triggers the safety function STO when the motor speed is below the specified limit
SBC	Safe Brake Control The safety function SBC provides the safety output signal to control an external brake

Supported Safety Function Not Defined in IEC 61800-5-2

Definitions

Acronym	Description
SMS	Safe Maximum Speed The safety function SMS prevents the speed of the motor from exceeding the specified speed limit. If the motor speed exceeds the specified speed limit value, safety function STO or SS1 is triggered. The safety function SMS does not limit the frequency reference value.
GDL	Guard Door Locking The safety function GDL controls the guard door lock according to the shut down of the drive and the motor frequency.

Accessories

Terminal Adapter for Safety Module

Description	Weight in kg (lb)	Order no.
Connection terminal adapter for safety module, for easy wiring of several safety modules in the control cabinet	0.1 (0.22)	VW3M8810
Connector with wire jumper (for INTERLOCK signal) for terminal adapter; four pieces	-	VW3M8820

Cable for Safety Module

Description	Weight in kg (lb)	Order no.
Cable for safety module, 3 m; 24-pin connector, other cable ends open	0.025 (0.055)	VW3M8801R30
Cable for safety module, 1.5 m; 2 x 24-pin connector	0.02 (0.044)	VW3M8802R15
Cable for safety module, 3 m; 2 x 24-pin connector	0.15 (0.33)	VW3M8802R30

Encoder Module

Description	Weight in kg (lb)	Order no.
Digital encoder interface module	0.15 (0.33)	VW3A3420
Analog encoder interface module	0.15 (0.33)	VW3A3422
Resolver interface module	0.15 (0.33)	VW3A3423
HTL encoder interface module	0.15 (0.33)	VW3A3424

Additional Module Support

Description	Weight in kg (lb)	Order No.
Additional module support: "green box" to add a slot for an option module.	0.4 (0.89)	VW3A3800
Only for ATV340 with power range equal to or higher than 30 kW (40 HP).		

Certifications

EC Declaration of Conformity

The EC Declaration of Conformity for the EMC Directive can be obtained on www.schneider-electric.com.

Functional Safety Certification

The integrated safety functions are compatible and certified according to IEC 61800-5-2 Ed.2 Adjustable speed electrical power drive systems - Part 5-2: Safety requirements - Functional.

IEC 61800-5-2, as a product standard, sets out safety-related considerations of Power Drive System Safety Related PDS (SR)s in terms of the framework of the IEC 61508 Ed.2 series of standards.

Compliance with the IEC 61800-5-2 standard, for the safety functions described below, facilitate incorporation of a PDS (SR) (Power Drive System suitable for use in safety-related applications) into a safety-related control system using the principles of IEC 61508, or IEC 13849-1, as well as IEC 62061 for process systems and machinery.

The defined safety functions are:

- SIL2 and SIL3 capability in compliance with IEC 61800-5-2 and the IEC 61508 Ed.2 series.
- Performance level d and e in compliance with ISO 13849-1.
- Compliant with Category 3 and 4 of ISO 13849-1.

Also refer to safety function Capability.

The safety demand operating mode is considered to be high demand or continuous mode of operation according to the IEC 61800-5-2 standard.

The functional safety certificate is accessible on www.schneider-electric.com.

Basics

Functional Safety

Automation and safety engineering are two areas that were completely separate in the past but have recently become more and more integrated.

The engineering and installation of complex automation solutions are greatly simplified by integrated safety functions.

Usually, the safety engineering requirements depend on the application.

The level of requirements results from the risk and the hazard potential arising from the specific application.

IEC 61508 Standard

The standard IEC 61508 Functional safety of electrical/electronic/programmable electronic safety-related systems covers the safety-related function.

Instead of a single component, an entire function chain (for example, from a sensor through the logical processing units to the actuator) is considered as a unit.

This function chain must meet the requirements of the specific safety integrity level as a whole.

Systems and components that can be used in various applications for safety tasks with comparable risk levels can be developed on this basis.

SIL - Safety Integrity Level

The standard IEC 61508 defines 4 safety integrity levels (SIL) for safety functions.

SIL1 is the lowest level and SIL4 is the highest level.

A hazard and risk analysis serves as a basis for determining the required safety integrity level.

This is used to decide whether the relevant function chain is to be considered as a safety function and which hazard potential it must cover.

PFH - Probability of a Dangerous Hardware Failure Per Hour

To maintain the safety function, the IEC 61508 standard requires various levels of measures for avoiding and controlling detected faults, depending on the required SIL.

All components of a safety function must be subjected to a probability assessment to evaluate the effectiveness of the measures implemented for controlling detected faults.

This assessment determined the PFH (Average frequency of dangerous failure) for a safety system.

This is the probability per hour that a safety system fails in a hazardous manner and the safety function cannot be correctly executed.

Depending on the SIL, the PFH must not exceed certain values for the entire safety system.

The individual PFH values of a function chain are added. The result must not exceed the maximum value specified in the standard.

Safety Integrity Level	Average frequency of dangerous failure (PFH) at high demand or continuous demand
4	$\geq 10^{-9} \dots < 10^{-8}$
3	$\geq 10^{-8} \dots < 10^{-7}$
2	$\geq 10^{-7} \dots < 10^{-6}$
1	$\geq 10^{-6} \dots < 10^{-5}$

PL - Performance Level

The standard ISO 13849-1 defines 5 Performance levels (PL) for safety functions.

a is the lowest level and e is the highest level.

Five levels (a, b, c, d, and e) correspond to different values of Average frequency of dangerous failure.

Performance level	Probability of a dangerous Hardware Failure per Hour
e	$\geq 10^{-8} \dots < 10^{-7}$
d	$\geq 10^{-7} \dots < 10^{-6}$
c	$\geq 10^{-6} \dots < 3 * 10^{-6}$
b	$\geq 3 * 10^{-6} \dots < 10^{-5}$
a	$\geq 10^{-5} \dots < 10^{-4}$

HFT - Hardware Fault Tolerance and SFF - Safe Failure Fraction

Depending on the SIL for the safety system, the IEC 61508 standard requires a specific hardware fault tolerance HFT in connection with a specific proportion of safe failures SFF (Safe Failure Fraction).

The hardware fault tolerance is the ability of a system to execute the required safety function in spite of the presence of one or more hardware faults.

The SFF of a system is defined as the ratio of the rate of safe failures and dangerous detected failures to the total failure rate of the system.

$$SFF = (\Sigma\lambda_s + \Sigma\lambda_{Dd}) / (\Sigma\lambda_s + \Sigma\lambda_{Dd} + \Sigma\lambda_{Du})$$

$\Sigma\lambda_s$: Safe failures

$\Sigma\lambda_{Dd}$: Dangerous detected failures

$\Sigma\lambda_{Du}$: Dangerous undetected failures

According to IEC 61508, the maximum achievable SIL of a system is partly determined by the hardware fault tolerance HFT and the safe failure fraction SFF of the system.

IEC 61508 distinguishes two types of subsystem (type A subsystem, type B subsystem).

These types are specified on the basis of criteria which the standard defines for the safety-relevant components.

SFF	HFT type A subsystem			HFT type B subsystem		
	0	1	2	0	1	2
< 60%	SIL1	SIL2	SIL3	----	SIL1	SIL2
60%...< 90%	SIL2	SIL3	SIL4	SIL1	SIL2	SIL3
90%...< 99%	SIL3	SIL4	SIL4	SIL2	SIL3	SIL4
≥99%	SIL3	SIL4	SIL4	SIL3	SIL4	SIL4

PFD - Probability of Failure on Demand

The standard IEC 61508 defines SIL using requirements grouped into two broad categories: hardware safety integrity and systematic safety integrity. A device or system must meet the requirements for both categories to achieve a given SIL.

The SIL requirements for hardware safety integrity are based on a probabilistic analysis of the device. To achieve a given SIL, the device must meet targets for the maximum probability of dangerous failure and a minimum Safe Failure Fraction. The concept of 'dangerous failure' must be rigorously defined for the system in question, normally in the form of requirement constraints whose integrity is verified throughout system development. The actual targets required vary depending on the likelihood of a demand, the complexity of the device(s), and types of redundancy used.

The PFD (Probability of Failure on Demand) and RRF (Risk Reduction Factor) of low demand operation for different SILs are defined in IEC 61508 are as follows:

SIL	PFD	PFH (power of ten)	RRF
1	0.1 - 0.01	$10^{-1} - 10^{-2}$	10 - 100
2	0.01 - 0.001	$10^{-2} - 10^{-3}$	100 - 1000
3	0.001 - 0.0001	$10^{-3} - 10^{-4}$	1000 - 10,000
4	0.0001 - 0.00001	$10^{-4} - 10^{-5}$	10,000 - 100,000

In high demand or continuous operation, these changes to the following:

SIL	PFH	PFH (power of ten)	RRF
1	0.00001 - 0.000001	$10^{-5} - 10^{-6}$	100,000 - 1,000,000
2	0.000001 - 0.0000001	$10^{-6} - 10^{-7}$	1,000,000 - 10,000,000
3	0.0000001 - 0.00000001	$10^{-7} - 10^{-8}$	10,000,000 - 100,000,000
4	0.00000001 - 0.000000001	$10^{-8} - 10^{-9}$	100,000,000 - 1,000,000,000

The hazards of a control system must be identified then analyzed in a risk analysis. These risks are gradually mitigated until their overall contribution to the hazard is deemed to be acceptable. The tolerable level of these risks is specified as a safety requirement in the form of a target probability of a dangerous failure over a given period, stated as a discrete SIL level.

Fault Avoidance Measures

Systematic errors in the specifications, in the hardware and the software, usage faults and maintenance faults in the safety system must be avoided to the maximum degree possible. To meet these requirements, IEC 61508 specifies a number of measures for fault avoidance that must be implemented depending on the required SIL. These measures for fault avoidance must cover the entire life cycle of the safety system, i.e. from design to decommissioning of the system.

Safety Function Capability

PDS (SR) Safety Functions are Part of an Overall System

If the qualitative and quantitative safety objectives determined by the final application require some adjustments to ensure safe use of the safety functions, the integrator of the BDM (Basic Drive Module) is responsible for these additional changes (for example, managing the mechanical brake on the motor).

Also, the output data generated by the use of safety functions (fault relay activation, error codes, or information on the display, and so on) is not considered to be safety-related data.

Response Times

Contact your Schneider Electric Customer Care Center (CCC) for more information.

SIL and PL Table for the Safety Functions

The following table provides the SIL and PL details for the safety functions of the safety module according to IEC 61508 and ISO 13849:

Safety Functions	Type of motor (2)	Open/closed loop motor control (1)	SIL Safety integrity level	PL Performance Level
SS1 SLS SMS	Asynchronous	Open	SIL 2	PL d
	Asynchronous or Synchronous	Closed	SIL 3	PL e
SBC	Asynchronous	Open or Closed	SIL 3	PL e
	Synchronous	Closed	SIL 3	PL e
GDL	Asynchronous	Open or Closed	SIL 2	PL d
	Synchronous	Closed	SIL 2	PL d

(1): Closed loop motor control used an encoder. The SIL of the used encoder must be at least SIL2 according to standard IEC 61508. For mechanical coupling, the shape of this safety encoder and the motor shaft must fit together.
 (2): Synchronous motors correspond to permanent magnet motors. Reluctance motors cannot be used with the safety module (*see page 87*)

Summary of the Reliability Study

The following table provides the SIL and PL details for the safety functions of the safety module according to IEC 61508 and ISO 13849:

Function	Standard	Type of Motor and control loop control	Asynchronous motor in Open loop control	Asynchronous or Synchronous ⁽³⁾ motor in Closed loop control
SS1, SLS, SMS	IEC 61508 Ed.2	SFF	>90%	>90%
		PFD _{20y}	3.8.10 ⁻³ (6) 5.2.10 ⁻³ (7)	2.2.10 ⁻⁴ (6) 2.8.10 ⁻⁴ (7)
		PFH _{equ_1y}	27 FIT (1)(6) 44 FIT (1)(7)	0.98 FIT (1)(6) 1.6 FIT (1)(7)
		Type	B	B
		HFT	0	1
		DC	>90%	>90%
		SIL capability	2	3
	IEC 62061 (2)	SIL CL capability	2	3
	IEC 60204-1	Category stop	1 for SS1	1 for SS1
	ISO 13849-1 (4)	PL	d	e
		Category	2 & 3	3
		MTTFd in years	82 (5)	75

Function	Standard	Type of Motor and control loop control	Asynchronous motor in Open loop control	Asynchronous or Synchronous ⁽³⁾ motor in Closed loop control
SBC	IEC 61508 Ed.2	SFF	>90%	
		PFD _{20y}	1.6.10 ⁻⁴	
		PFH _{equ_1y}	0.27 FIT ⁽¹⁾	
		Type	B	
		HFT	1	
		DC	>90%	
		SIL capability	3	
	IEC 62061 ⁽²⁾	SIL CL capability	3	
	ISO 13849-1 ⁽⁴⁾	PL	e	
		Category	3	
MTTFd in years		1300		
GDL	IEC 61508 Ed.2	SFF	>90%	
		PFD _{20y}	1.8.10 ⁻³	
		PFH _{equ_1y}	4 FIT ⁽¹⁾	
		Type	B	
		HFT	0	
		DC	>90%	
		SIL capability	2	
	IEC 62061 ⁽²⁾	SIL CL capability	2	
	ISO 13849-1 ⁽⁴⁾	PL	d	
		Category	2	
MTTFd in years		600		

(1) FIT: Failure In Time = 10⁻⁹ failure per hour.

(2) Because the IEC 62061 standard concerns integration, this standard distinguishes the overall safety function (which is classified SIL2 or SIL3 for ATV340/ATV900 according to diagrams Process system SF - Case 1 and Process system SF - Case 2, from components which constitute the safety function (which is classified SIL2 CL or SIL3 CL for ATV340/ATV900).

(3) Permanent magnets synchronous motors. Reluctance motors are not covered by the safety module.

(4) According to EN 13849-1:2015.

(5) MTTFd of STO function is not taken into account

(6) For drives with power range equal to or less than 22 kW.

(7) For drives with power range equal to or greater than 30 kW.

Preventive annual activation of the safety function is recommended.

However, the safety levels can be obtained (with lower margins) without annual activation.

NOTE: The table above is not sufficient to evaluate the PL of a PDS. The PL evaluation has to be done at the system level. The fitter or the integrator of the BDM (Basic Drive Module) has to do the system PL evaluation by including sensors data with numbers from the table above.

NOTE: In case of closed loop control, the value given in the preceding table can be reached if the SIL of the used encoder is at least SIL2 according to standard IEC 61508. For mechanical coupling, the shape of this safety encoder and the motor shaft must fit together.

Chapter 2

Technical Data

What Is in This Chapter?

This chapter contains the following sections:

Section	Topic	Page
2.1	Safety Module	28
2.2	Terminal Adapter (VW3M8810)	36
2.3	Wiring for Multi-Axis System	42

Section 2.1 Safety Module

What Is in This Section?

This section contains the following topics:

Topic	Page
Electrical Data	29
Installation of the Safety Module	31
Electrical Installation	32
Pin Layout of the Safety Module	35

Electrical Data

Overview

The connector of the safety module has the following pins:

- a 24 Vdc input supply voltage,
- 1 dual-channel 24 Vdc output supply voltage (CCM24V_OUT),
- 4 dual-channel safety inputs (SI1, SI2, SI3, and SI4),
- 3 single-channel safety inputs (SI5, SI6 and SI7),
- 1 dual-channel safety output (SQ1),
- 1 single-channel safety output (SQ3),
- 2 single-channel outputs (SQ2_A and SQ2_B).

Logic Type

The inputs of the safety module must only be wired in source mode: current flows to an input.

The outputs of the safety module must only be wired in source mode: an output supplies current.

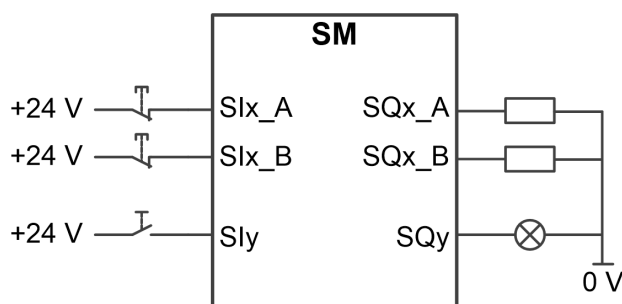

Six_A and Six_B: Safety Input x (Channel A and B)

Sly: Safety Input y

SQx_A and SQx_B: Safety Output x (Channel A and B)

SQy: Safety Output y

24 Vdc Supply Voltage

The supply voltage SM24VDC must meet the PELV requirements (PELV standard power supply)

	Unit	Range/ Value
Input voltage (V _{dc})	V (dc)	24 (-15% / +20%)
Input current required for the safety module without load on outputs	A	≤0.02
Input current required by the terminal adapter (accessory, without load on outputs)	A	≤0.05
Residual ripple	%	< 5

Signal Interface

Digital signal inputs: protected against reverse polarity, debounced

	Unit	Range / Value
0 level	V (dc)	-3...+5
1 level	V (dc)	+15...+30
Input current dual-channel input	mA	2.5
Input current single-channel input	mA	5
Debounce time ⁽¹⁾ (hardware and firmware)	ms	> 5
Time window for simultaneous switching (both channels)	s	1.8
(1): a pulse shorter than the debounce time is not taken into account by the safety module		

Digital signal outputs: short-circuit protected

	Unit	Range / Value
Suitable for inductive load	mJ	75 (maximum 15 H at 100 mA) Maximum 0.6 H at 500 mA
Suitable for capacitive loads	μF	≤1
Maximum switching current: SQ1_A, SQ1_B, SQ3 CCM24V_OUT_A, CCM24V_OUT_B SQ2_A, SQ2_B	A	≤0.5 ≤0.3 ≤0.1
Voltage drop at 0.5 A	V (dc)	≤1
Deactivation time for test	ms	≤1
Maximum time for detection of cross faults at activated outputs. For more information, refer to cross fault detection (see page 34)	s	≤5

Dual-channel safety input

A safety function assigned to a dual-channel safety input is activated when the first channel switches to low level (0). The safety function is deactivated when the second channel switches to high level (1).

Time window for simultaneous switching: If the channels have a different level for a time longer than 1.8 s, an error is triggered.

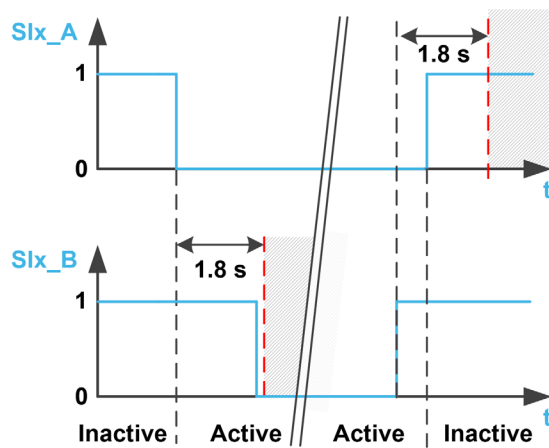

Installation of the Safety Module

Before You Begin

Before you install the module, ensure that the

- Catalog number given on the label of the module is same as that on the delivery note corresponding to the purchase order
- Safety Module is not damaged
- Additional module support (VW3A3800) is available for ATV340 with power range equal to or higher than 30 kW (40 HP).
- Cable for the safety module is available.
- Two ferrite beads delivered with the safety module are available for ATV340 with power range equal to or higher than 30 kW (40 HP),
- Software version of the drive is compatible with the safety module.

NOTE: In case of incompatible software version between the drive and the safety module, an error is triggered and the safety module cannot be configured.

Mechanical data

Weight:

- Safety Module VW3A3802: 0.02 kg (0.044 lb)
- Additional Module Support (VW3A3800): 0.4 kg (0.89 lb)

Dimensions:

- Safety Module VW3A3802: 41 x 109 x 23.25 mm (1.61 x 4.29 x 0.91 in)
- Additional Module Support VW3A3800: 128 x 147 x 65 mm (5.04 x 5.79 x 2.56 in)
- The use of an additional module support increases the depth values of the drive by maximum of 50.5 mm (1.97 in) depending on the catalog number of the drive. The additional module support takes place between the Display Terminal and the drive, causing the depth value to be increased.

Ambient Conditions

The ambient conditions to be met for the safety module correspond to the ambient conditions for the drive, see the installation manual of the drive ([see page 12](#)).

The following additional condition must be met: the maximum operating altitude is 3,000 m.

! WARNING
LOSS OF SAFETY FUNCTION CAUSED BY FOREIGN OBJECTS
Conductive foreign objects, dust or liquids may cause safety functions to become inoperative. Do not use a safety function unless you have protected the system against contamination by conductive substances.
Failure to follow these instructions can result in death, serious injury, or equipment damage.

Installation of the Additional module support (VW3A3800)

Refer to the Additional module support Instruction Sheet ([NHA80733](#)) to install the Additional module support on the drive.

Installation or removal of the Safety Module (VW3A3802)

The Safety Module (VW3A3802) can only be recognized on:

- the slot GP-SF for drives with power range equal to or less than 22 kW, or
- the slot C proposed by the additional module support for drives with power range equal to or higher than 30 kW. Install the additional module support before installing the safety module.

Refer to the Safety Module Instruction Sheet ([NVE46516](#)) to install or remove the safety module from the drive.

Electrical Installation

Interface

The safety module is connected using a 24-pin connector.

Cable Specification

The cable wired to the safety module must be one of the cables listed in the section “Accessories” (see page 19)

The minimum conductor cross section of these twisted-pair cables is 0.34 mm² (24* AWG 22).

The maximum cable length is 3 m. It corresponds to the maximum length between the safety module and the external devices. If the required distance is greater than 3 m, a VW3A3800 terminal adapter must be used. The maximum cable length between the terminal adapter and the safety module remains 3 m. Refer to the electrical installation of the terminal adapter for additional information (see page 38).

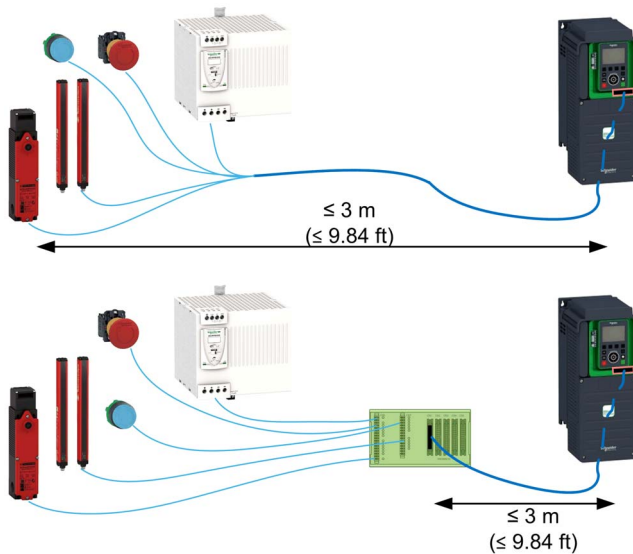

Verify that the wiring, cables, and connected interface meet the PELV (Protective Extra Low Voltage) requirements.

Observe the EMC requirements specified in the product manual.

Connecting the 24 Vdc Supply

⚠ DANGER

ELECTRIC SHOCK CAUSED BY INCORRECT POWER SUPPLY UNIT

The +24Vdc supply voltage is connected with many exposed signal connections in the drive system.

- Use a power supply unit that meets the PELV (Protective Extra Low Voltage) requirements.
- Connect the negative output of the power supply unit to PE (ground).

Failure to follow these instructions will result in death or serious injury.

The supply voltage of the control block terminals of the drive cannot be used as supply voltage for the safety module.

If the +24 Vdc supply voltage is disconnected from the safety module, the outputs of the safety module (including the output supply voltage) switch to low level (0) irrespective of their configuration.

To size the 24 Vdc supply of the terminal adapter, refer to the following table

Description	Range / value
Output Max Loads	≤3.7 A
(Load currents are provided by the safety module wired on CN1, CN2 and CN3)	CN1: ≤2.3 A CN2: ≤1.2 A CN3: ≤0.2 A

Description	Range / value
Maximum Inputs Consumptions	≤0.175 A (0.035 A for each safety module)
Permanent Consumption	≤0.15 A (0.05 + 0.02 x number of safety module)
Maximum 24 Vdc supply current for terminal adapter and safety modules	≤4 A

The following figure shows the connection of the safety module supply with and without terminal adapter.

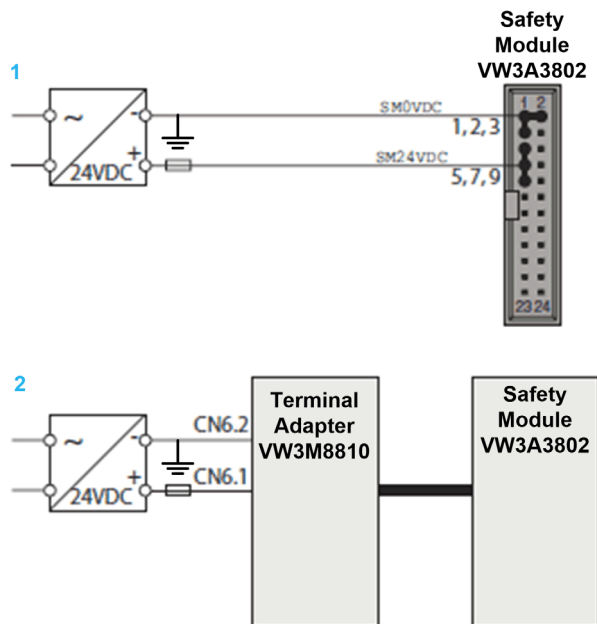

- 1 Without optional terminal adapter
- 2 With optional terminal adapter

Connecting the dual-channel safety inputs

The following figures shows the different type of connection for the dual-channel safety inputs:

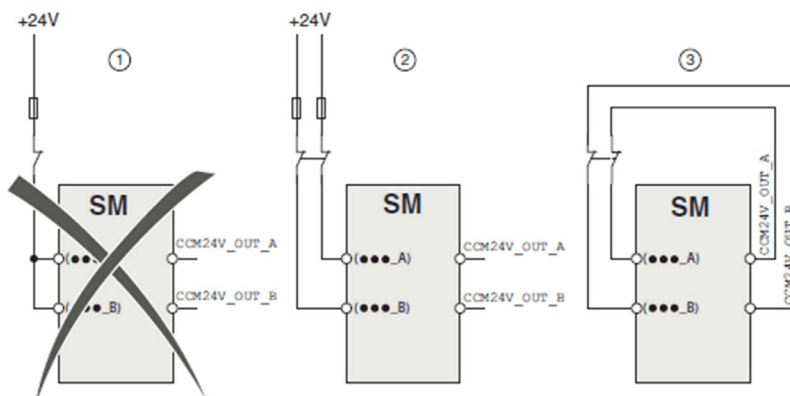

There are three ways of connecting the signals to the safety module

Item	Connection type	Description
1	Single-channel connection	The specified data (SIL, performance level) are not reached with single-channel connection.
2	Dual-channel connection	Cross faults between channels and short circuits to other voltage-carrying conductors are not detected. Protected cable installation as per ISO 13849-2 is required.
3	Dual-channel connection with cross fault detection	The specified data (SIL, Performance-Level) are reached. Dual-channel connection with cross fault detection allows for the detection of cross faults between signals ending with “_A” and signals ending with “_B”. Protected cable installation is not required.

Cross Fault Detection

The outputs CCM24V_OUT_A and CCM24V_OUT_B of the safety module provide 24 Vdc supply voltage with cross fault detection for command devices. In the case of dual-channel wiring and supply of the command devices with CCM24V_OUT_A and CCM24V_OUT_B, cross faults between channels and short circuits to other voltage-carrying conductors can be detected.

The figure shows the functional principle of cross fault detection

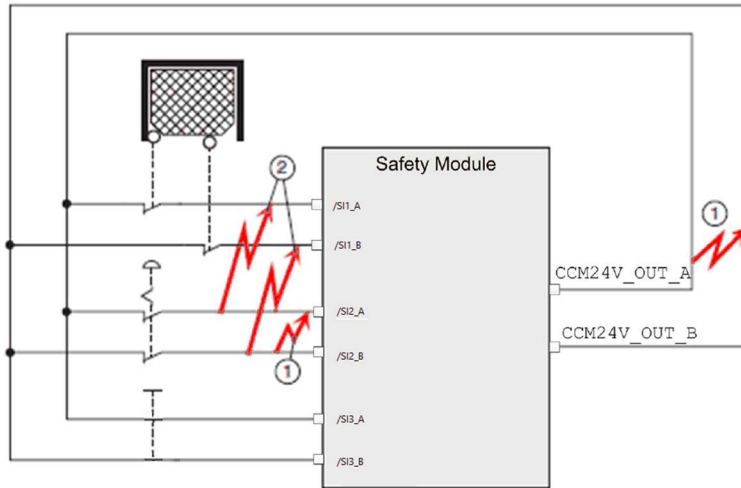

- 1 Cross fault detection only works with signals ending with **_A** to signals ending with **_B** with low-resistance connection to the 24 Vdc power supply.
- 2 Cross faults between a single redundant group (for example, **..._A** to **..._A**) are not detected.

Pin Layout of the Safety Module

Overview

The following figure shows the pin layout of the safety module connector

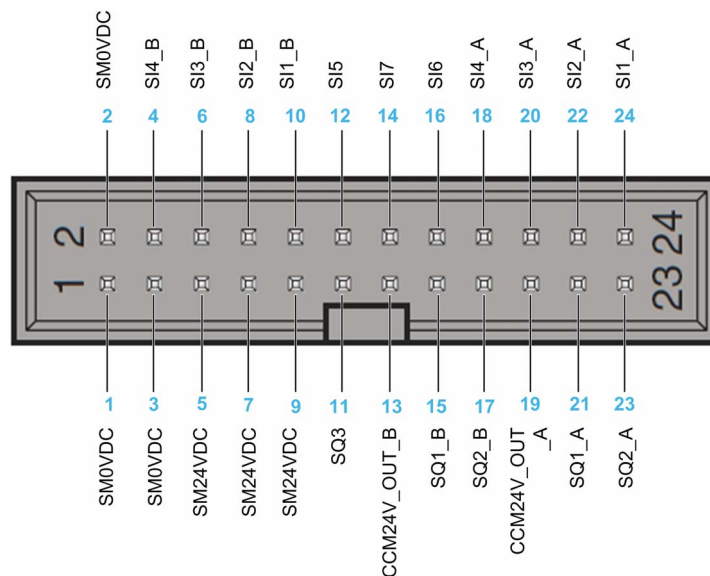

Pin Layout Table

Pin	Signal	I/O	Active Level	Description	VW3M8801R30 Wire Color
1	SM0VDC	-	-	Reference potential supply safety module	White
2	SM0VDC	-	-	Reference potential supply safety module	Brown
3	SM0VDC	-	-	Reference potential supply safety module	Green
4	SI4_B	I	Low	Configurable safety input SI4 (channel B)	Yellow
5	SM24VDC	-	-	Supply safety module	Grey
6	SI3_B	I	Low	Configurable safety input SI3 (channel B)	Pink
7	SM24VDC	-	-	Supply safety module	Blue
8	SI2_B	I	Low	Configurable input SI2 (channel B)	Red
9	SM24VDC	-	-	Supply safety module	Black
10	SI1_B	I	Low	Configurable safety input SI1 (channel B)	Violet
11	SQ3	O	Low	Configurable safety output SQ3	Pink, Grey
12	SI5	I	Low	Configurable safety input SI5	Blue, Red
13	CCM24V_OUT_B	O	High	Supply control device (channel B)	White, Green
14	SI7	I	Low	Configurable safety input SI7	Brown, Green
15	SQ1_B	O	High	Configurable safety output SQ1 (channel B)	White, Yellow
16	SI6	I	Low	Configurable safety input SI6	Brown, Yellow
17	SQ2_B	O	High	Configurable output SQ2_B	White, Grey
18	SI4_A	I	Low	Configurable safety input SI4 (channel A)	Brown, Grey
19	CCM24V_OUT_A	O	High	Supply control device (channel A)	White, Pink
20	SI3_A	I	Low	Configurable safety input SI3 (channel A)	Brown, Pink
21	SQ1_A	O	High	Configurable safety output SQ1 (channel A)	White, Pink
22	SI2_A	I	Low	Configurable safety output SI2 (channel A)	Brown, Blue
23	SQ2_A	O	High	Configurable output SQ2_A	White, Red
24	SI1_A	I	Low	Configurable safety input SI1 (channel A)	Brown, Red

Section 2.2

Terminal Adapter (VW3M8810)

What Is in This Section?

This section contains the following topics:

Topic	Page
Installation of Terminal Adapter	37
Electrical Installation	38
Pin Layout of Terminal Adapter	40

Installation of Terminal Adapter

Dimensions

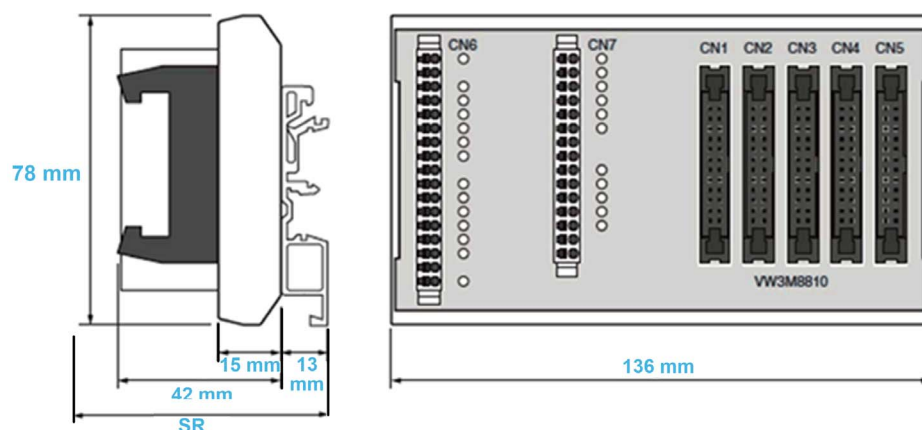

SR Space requirement (with cables connected to CN1...CN5): cable + 42 mm + 13 mm \geq 100 mm.

Ambient Conditions

The ambient conditions to be met for the terminal adapter correspond to the ambient conditions for the drive, see the installation manual of the drive ([see page 12](#)).

! WARNING

LOSS OF SAFETY FUNCTION CAUSED BY FOREIGN OBJECTS

Conductive foreign objects, dust or liquids may cause safety functions to become inoperative.

Do not use a safety function unless you have protected the system against contamination by conductive substances.

Failure to follow these instructions can result in death, serious injury, or equipment damage.

Installation of the terminal adapter

The terminal adapter can be mounted on standard DIN rails or on G-type rails.

To unlock the terminal adapter from the DIN rails, a minimum space of 10 mm is required.

Degree of protection as per IEC 60529:

The terminal adapter must be installed in a control cabinet with degree of protection IP54 (or higher). This is required to avoid cross faults and short circuits between terminals, connectors, tracks and safety-related circuitry caused by foreign objects.

Electrical Installation

Interface

A terminal adapter is an accessory used for multi-axes system. It centralizes the wiring. You can connect 1 to 5 safety modules with a single terminal adapter.

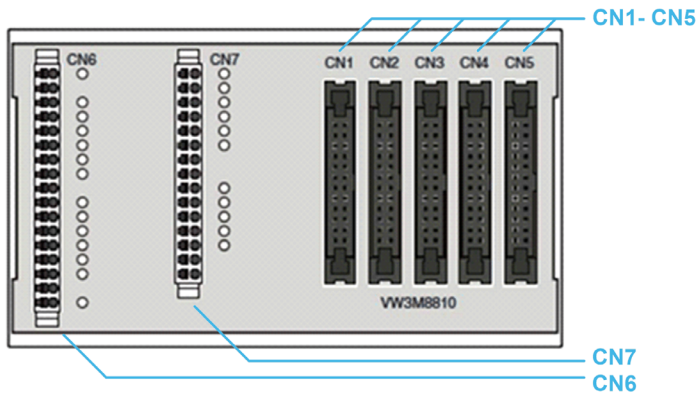

A terminal adapter has 7 terminals:

- 5 safety module terminals (CN1 to CN5): 24-pin female connectors used to connect safety modules. The pin layout of these connectors is similar to the pin layout of the safety module.
- CN6 spring terminal: a 17-pin connector used as inputs/outputs for the safety modules connected to the safety module terminals.
- CN7 spring terminal: a 15-pin connector used as inputs/outputs for the safety modules connected to the safety module terminals.

For additional information on CN6 and CN7, refer to the terminal adapter pin layout.

Connection Cross Sections for The Spring Terminals

The following table provides the connection cross-section for the spring terminal CN6...CN7

Specification	Unit	Range / Value
Connection cross section for rigid and flexible cables	mm ² (AWG)	0.2...1.5 AWG22...AWG16
Connection cross section for flexible cable with wire ferrule without plastic collar	mm ² (AWG)	0.25...1.5 AWG22...AWG16
Connection cross section for flexible cable with wire ferrule with plastic collar	mm ² (AWG)	0.25...0.75 AWG22...AWG20

Shielded Cables for The Spring Terminals

The cables connected to spring terminals (CN6 and CN7) must be shielded and grounded at both ends.

To ground this cable near the terminal adapter, you can use a shield connection terminal block to connect the shield of the cable to the rail that has the terminal adapter mounted on (solution not provided by Schneider-Electric). See an example below.



Chaining of The INTERLOCK Signal

The terminal adapter chains the INTERLOCK signal between the terminals (CN1...CN5).

To properly spread the signal from the input (SI7_5) to the output (SQ3_1) of the terminal adapter, you must connect a safety module or a wire jumper (see accessories) on each safety module terminals (CN1...CN5).

Each connected safety module must be properly configured in order to chain the INTERLOCK signal.

NOTE: The INTERLOCK signal can be used to chain the SBC Feedback or the Guard Door Lock (see page 74).

Following an example of chaining of the INTERLOCK signal with three safety modules (SM1, SM2 and SM5) and 2 wire jumpers:

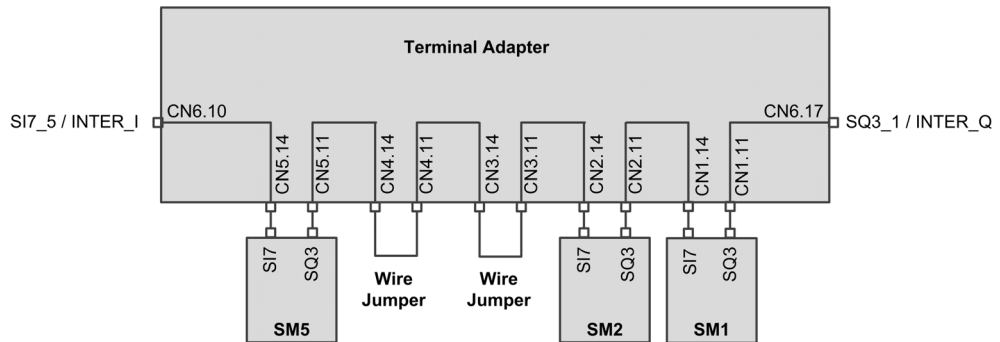

Pin Layout of Terminal Adapter

Overview

The following figure shows the pin layout of the spring terminal CN6 and CN7

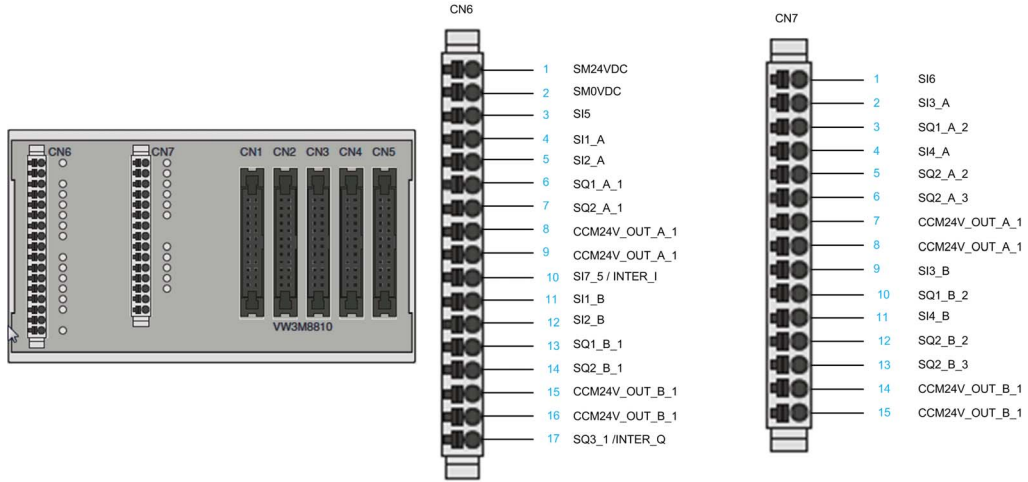

NOTE: A sticker is provided with the Terminal Adapter for CN6-CN7 pin arrangement.

Pin Layout Table

CN1 to CN5 are 24-pin connectors. These connectors present the same pin layout than the Safety module. There are used to connect Safety Module in serial (up to 5).

The following table provides the pin assignment for spring terminal CN6 of the terminal adapter.

Pin	Signal	I/O	Active Level	Description	Linked CN
1	SM24VDC	-	-	Supply safety modules	CN1 to CN5
2	SM0VDC	-	-	Reference potential Supply safety modules	CN1 to CN5
3	SI5	I	Low	Configurable safety input SI5	CN1 to CN5
4	SI1_A	I	Low	Configurable safety input SI1 (channel A)	CN1 to CN5
5	SI2_A	I	Low	Configurable safety input SI2 (channel A)	CN1 to CN5
6	SQ1_A_1	O	High	Configurable safety output SQ1 (channel A)	CN1
7	SQ2_A_1	O	High	Configurable output SQ2 (channel A)	CN1
8	CCM24V_OUT_A_1	O	High	Supply control device (channel A)	CN1
9	CCM24V_OUT_A_1	O	High	Supply control device (channel A)	CN1
10	SI7_5	I	Low	Configurable Safety Input SI7	CN5
11	SI1_B	I	Low	Configurable Safety Input SI1 (channel B)	CN1 to CN5
12	SI2_B	I	Low	Configurable Safety Input SI2 (channel B)	CN1 to CN5
13	SQ1_B_1	O	High	Configurable Safety Output SQ1 (channel B)	CN1
14	SQ2_B_1	O	High	Configurable Output SQ2 (channel B)	CN1
15	CCM24V_OUT_B_1	O	High	Configurable Control Device (channel B)	CN1
16	CCM24V_OUT_B_1	O	High	Configurable Control Device (channel B)	CN1
17	SQ3_1	O	Low	Configurable Safety Output SQ3 (channel B)	CN1

The following table provides the pin assignment for spring terminal CN7 of the terminal adapter.

Pin	Signal	I/O	Active Level	Description	Linked CN
1	SI6	I	Low	Configurable safety input SI6	CN1 to CN5
2	SI3_A	I	Low	Configurable safety input SI3 (channel A)	CN1 to CN5
3	SQ1_A_2	O	High	Configurable safety output SQ1 (channel A)	CN2
4	SI4_A	I	Low	Configurable safety input SI4 (channel A)	CN1 to CN5

Pin	Signal	I/O	Active Level	Description	Linked CN
5	SQ2_A_2	O	High	Configurable output SQ2_A	CN2
6	SQ2_A_3	O	High	Configurable output SQ2_A	CN3
7	CCM24V_OUT_A_1	O	High	Supply control device (channel A)	CN1
8	CCM24V_OUT_A_1	O	High	Supply control device (channel A)	CN1
9	SI3_B	I	Low	Configurable safety input SI3 (channel B)	CN1 to CN5
10	SQ1_B_2	O	High	Configurable Safety output SQ1 (channel B)	CN2
11	SI4_B	I	Low	Configurable Safety Input SI4 (channel B)	CN1 to CN5
12	SQ2_B_2	O	High	Configurable output SQ2_B	CN2
13	SQ2_B_3	O	High	Configurable Output SQ2_B	CN3
14	CCM24V_OUT_B_1	O	High	Supply control device (channel B)	CN1
15	CCM24V_OUT_B_1	O	High	Supply control device (channel B)	CN1

Section 2.3

Wiring for Multi-Axis System

What Is in This Section?

This section contains the following topics:

Topic	Page
Overview	43
Wiring with Terminal Adapter	45

Overview

Introduction

Multi-axis system can be composed of several safety modules VW3A3802 or it can be composed of safety modules VW3A3802 mixed with ATV320 drives and ESM safety module for Lexium 32 (VW3M3501). Other possibilities of multi-axis system should be excluded.

If a single safety relay module is used for several axes, then

- Inputs of the safety modules must be connected in parallel
- Outputs of the safety module must not be connected in parallel.

In case of multi-axes system, the input current depends on:

- The number of safety modules connected,
- The number of inputs and outputs used,
- The load on the outputs.

The voltage drops on the lines in the case of higher currents

Requirements for Multi-Axis System with The Safety Module

A multi-axis system with safety modules VW3A3802 requires the use of at least one terminal adapter (see accessories).

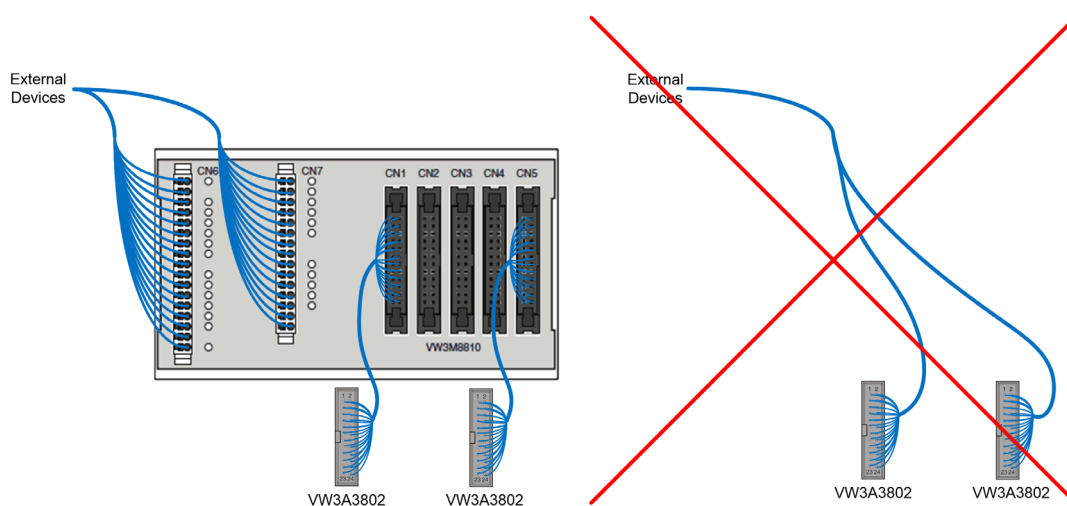

Use of several safety modules with a terminal adapter implies to have a consistent configuration between the connected safety modules. For example, but not limited to, a consistency between the configuration of the inputs and outputs of each safety module.

On a terminal adapter (CN1-CN5), it is not allowed to combine VW3A3802 safety modules with other safety elements (such as ATV320 or the ESM safety module for Lexium 32: VW3M3501).

To include a safety module VW3A3802 in a mixed architecture (i.e. with ATV320, ESM safety module for Lexium 32, etc.), the VW3A3802 must be wired to one of the terminals CN1 to CN5 and linked to the rest of the architecture through the terminals CN6 and CN7.

Above 5 safety modules (VW3A3802), two or more terminal adapters must be used depending on your requirements. The connection between the terminal adapters must be done via the terminals CN6 and CN7.

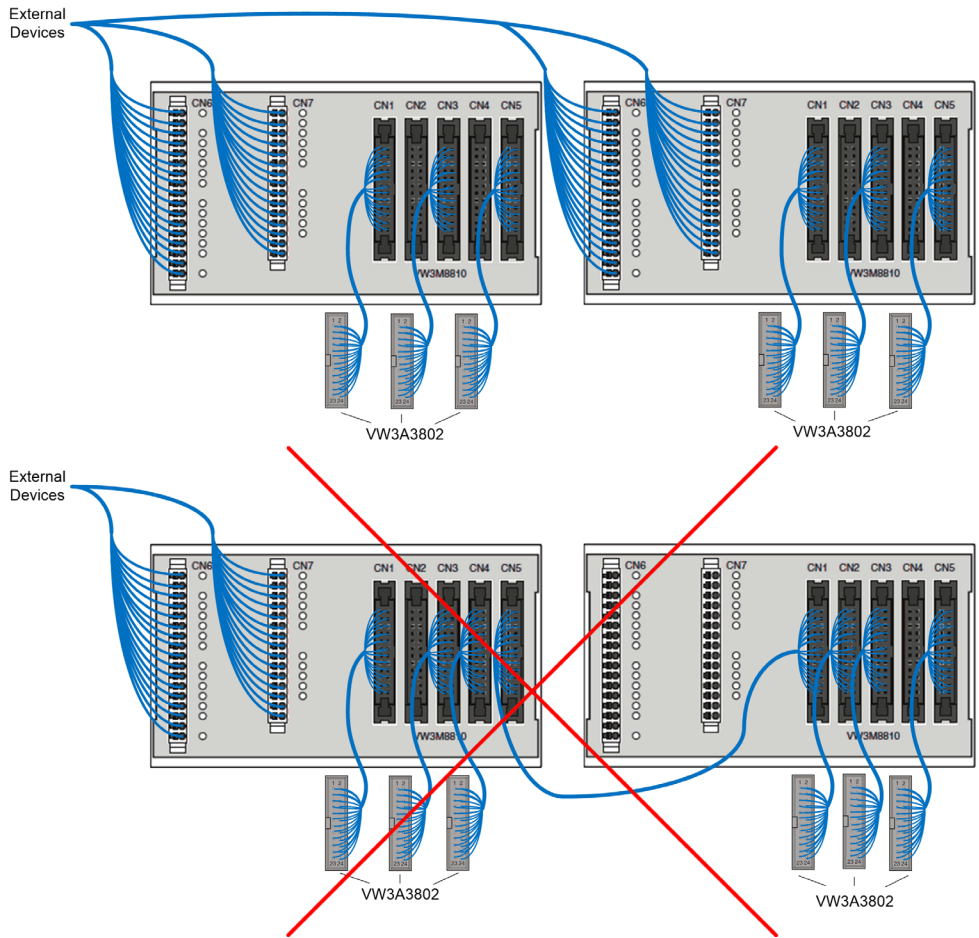

Note:

- The cable wired between the safety module and the terminal (CN1-CN5) of the terminal adapter must be one of the cables listed in the Accessories (*see page 19*).
- The cables connected to the terminals CN6-CN7 of the terminal adapter must be shielded.

Wiring with Terminal Adapter

Limitations of the terminal adapter

Following the limitations of wiring several safety modules with a single terminal adapter:

- At terminals CN6, the input supply voltage (SM24VDC, SM0VDC) is connected to all the safety module terminals (via CN1 to CN5).
- Only the output power supply (CCM24V_OUT_A&B) of the terminal CN1 is connected to the terminals CN6 and CN7 (CCM24V_OUT_A&B_1).
- At terminals CN6 and CN7, only SQ1_A&B of CN1 and CN2 are available. SQ1_A&B of CN3 to CN5 are not available.
- At terminals CN6 and CN7, only SQ2_A and SQ2_B of CN1 to CN3 are available. SQ2_A and SQ2_B of CN4 and CN5 are not available.
- At terminals CN6 and CN7, the dual-channel safety inputs (SI1_A&B to SI4_A&B) are common to all safety module terminals (CN1 to CN5).
- At terminals CN6 and CN7, the safety inputs SI5 and SI6 are common to all the safety module terminals (CN1 to CN5).
- Only the safety input SI7 of the terminal CN5 is available on the terminal CN6. Only the safety output SQ3 of the terminal CN1 is available on the terminal CN6. The terminal adapter chains internally the signal SQ3-SI7. For example, the safety output SQ3 of the terminal CN5 is connected to the safety input SI7 of the terminal CN4 (see page 39)

Terminal adapter wiring layout

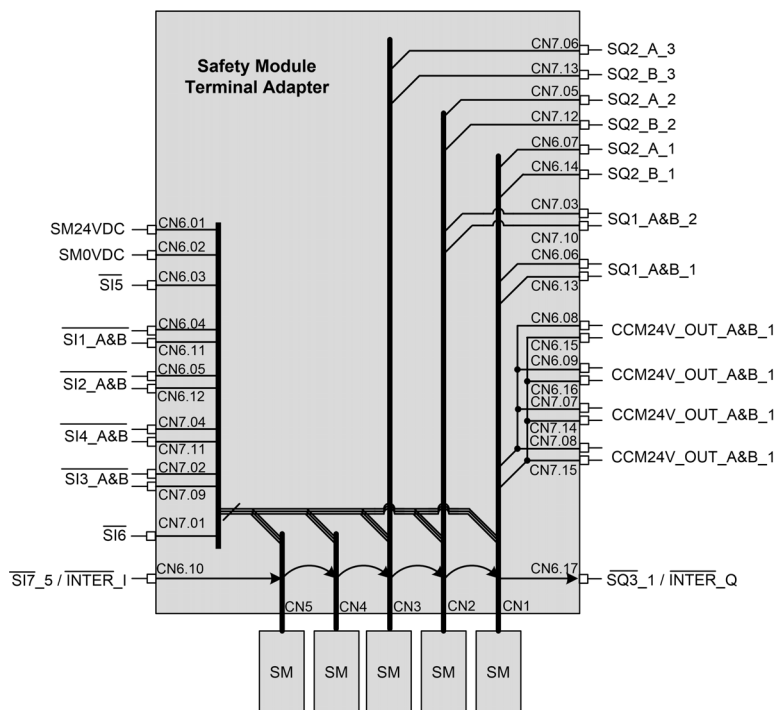

Chapter 3

Safety Functions

What Is in This Chapter?

This chapter contains the following topics:

Topic	Page
Safety Function STO (Safe Torque Off) with The Safety Module	48
Safety Function SS1 (Safe Stop 1)	49
Safety Function SLS (Safely Limited Speed)	53
Safety Function SBC (Safe Brake Control)	64
Safety Function SMS (Safe Maximum Speed)	69
Safety Function GDL (Guard Door Locking)	74

Safety Function STO (Safe Torque Off) with The Safety Module

Overview

STO is a Safe Torque Off defined by IEC 61800-5-2.

The Safe Torque Off (STO) function is the standard function embedded to the drive. Refer to the Embedded Safety Function manual of the drive for further information ([see page 12](#)).

The safety module is an option module of the drive. If the safety module is inserted then the safety function STO cannot be activated with the STO inputs of the drive (STOA and **STOB**). In this case, the STO inputs of the drive (**STOA** and **STOB**) must be wired to 24V supply. Otherwise, a **S r F** error is triggered by the safety module and the safety module outputs are disabled.

STO with the Safety Module

If the safety module is inserted then the safety function STO can only be activated internally by the safety module via:

- The safety functions SS1, SMS and SLS (such as detection of a violation error, reaching of SS1 standstill level or reaching of SLS standstill level depending on the type of SLS).
- The detection of an error class 3 or 4 by the safety module. Refer to diagnostics and troubleshooting ([see page 117](#))

To disable the safety function STO activation, you must:

- Remove the causes of the detected errors and clear the error codes if errors have been triggered,
- Remove the safety function requests (switch the safety inputs linked to the safety functions to high level),
- Depending on your configuration, send the start signal ([see page 78](#)).

For more information refer to Operating States and State Transitions ([see page 116](#)).

Safety Function SS1 (Safe Stop 1)

Overview

The safety function SS1 monitors the motor frequency deceleration and safely shuts off the torque (STO function) once the standstill has been reached.

In addition of the deceleration monitoring, the safety module can control the motor frequency deceleration depending on the setting value of the parameter **[SS1 drive control] 5 L 3 B**:

- **External**: the deceleration of the frequency reference value must be done via the active frequency reference channel of the drive. Without modification of the reference frequency, there is no deceleration and the monitoring deceleration ramp is violated.
- **Automatic**: the deceleration of frequency reference value follows a ramp defined by the parameter **[SS1 Commanded Ramp] 5 L 3 D** of the safety module.

The safety function SS1 can be activated via the dual channel safety-related input assigned to **[SS1 input assignment] 5 L 2 7** (function active at low level of the input).

SS1 can also be activated via another safety function such as:

- The safety function SLS (type 3 and type 6),
- The safety function SMS depending on the configuration of **[SMS Violation Response] 5 L 5 1**.

SS1 is triggered if an error class 2 is detected (*see page 117*).

To use the safety module, the safety function SS1 must be configured.

Behavior on Activation of the Safety Function SS1

At SS1 activation:

- Depending on **[SS1 drive control] 5 C 3 B**, the motor frequency decelerates according to **[SS1 commanded deceleration] 5 C 3 D** or the active frequency reference channel of the drive,
- At the end of the delay **[SS1 delay before monitoring] 5 C 3 4**, the motor frequency is monitored by a ramp. This monitoring ramp is defined by:
 - Its deceleration set by the parameter **[SS1 Monitored deceleration] 5 C 3 1**.
 - Its starting frequency defined by the parameter **[SS1 offset] 5 C 3 2** plus the maximum motor frequency reached during **[SS1 delay before monitoring] 5 C 3 4**.
- If the monitored ramp is violated, the safety function STO is activated and a **5 R V F** error is triggered. This error can be reset without power cycle. If **[SS1 restricted ramp violation] 5 C 3 5** sets to **Active**, at the 5th SS1 activation with monitored ramp violation, the error triggered can only be reset with a power cycle.
- If the motor frequency reaches **[SS1 standstill Level] 5 C 3 3**, the monitoring of the motor frequency is deactivated and the safety function STO is activated.

The following figure shows the safety function SS1 with **[SS1 drive control] 5 C 3 B** set to **Automatic**:

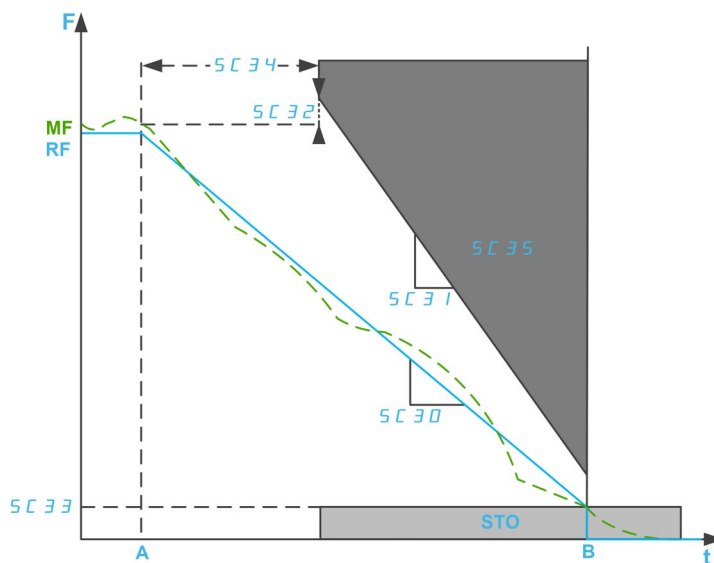

F: Frequency / **RF:** Reference Frequency / **MF:** Motor Frequency

t: time

A: SS1 activation

B: STO activation

SC30: SS1 commanded deceleration

SC31: SS1 monitored deceleration / **SC32:** SS1 Offset

SC33: SS1 standstill level (for open loop control)

SC34: SS1 delay before monitoring

SC35: SS1 restricted ramp violation

The following figure shows the safety function SS1 with **[SS1 drive control] 5 C 3 6** set to External:

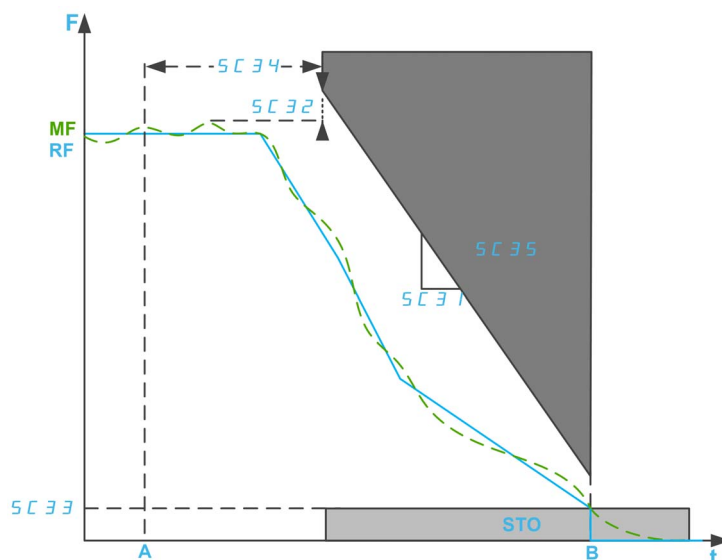

F: Frequency / RF: Reference Frequency / MF: Motor Frequency

t: time

A: SS1 activation

B: STO activation

SC31: SS1 monitored deceleration / SC32: SS1 Offset

SC33: SS1 standstill level (for open loop control)

SC34: SS1 delay before monitoring

SC35: SS1 restricted ramp violation

Safety function SS1 parameters

Parameter	Description	Possible values	Description
[SS1 input assignment] 5 C 2 7	It allows you to assign a safety-related inputs (dual channel) to activate the safety function SS1.	<ul style="list-style-type: none"> Not assigned SI1 SI2 SI3 SI4 	<ul style="list-style-type: none"> Not assigned Assigned to SI1_A and SI1_B Assigned to SI2_A and SI2_B Assigned to SI3_A and SI3_B Assigned to SI4_A and SI4_B
[SS1 drive control] 5 C 3 6	Configure the source of the reference frequency used during the ramp deceleration.	<ul style="list-style-type: none"> External Automatic 	<ul style="list-style-type: none"> The active frequency reference channel of the drive. The safety module via the parameter [SS1 commanded deceleration] 5 C 3 0.
[SS1 Commanded deceleration] 5 C 3 0	Configure the deceleration command ramp used if the motor frequency is greater than [SS1 Standstill Level] 5 C 3 3 . Note: this parameter can be accessed if [SS1 drive control] 5 C 3 6 is set to Automatic.	<ul style="list-style-type: none"> Undefined 0.1...20,000 Hz/s Step: 0.1 Hz/s	Setting range. It is recommended to configure this parameter to a value equal to or greater than [SS1 Monitored deceleration] 5 C 3 1 .
[SS1 monitored deceleration] 5 C 3 1	Configure the deceleration monitoring ramp used if the motor frequency is greater than [SS1 Standstill Level] 5 C 3 3 .	<ul style="list-style-type: none"> Undefined 0.1...20,000 Hz/s Step: 0.1 Hz/s	Setting range. This parameter must be set to a value different from Undefined.

Parameter	Description	Possible values	Description
[SS1 Offset] 5 C 3 2	Configure the added offset value for the monitored ramp.	0...200.0 Hz Step: 0.1 Hz	Setting range. It is recommended to configure this parameter to a value equal to or greater than the maximum motor frequency overshoot plus 5 C 0 4.
[SS1 Standstill Level] 5 C 3 3	Configure the low limit of the motor frequency monitoring and the STO activation level.	<ul style="list-style-type: none"> ● Undefined ● 0.1...20,000 Hz/s Step: 0.1 Hz/s	Setting range. This parameter must be configured to a value greater than the minimum observable frequency.
[SS1 delay before monitoring] 5 C 3 4	Configure the delay at SS1 activation before to start the ramp monitoring.	0...3,000 ms Step: 1 ms	Setting range.
[SS1 restricted ramp violation] 5 C 3 5	Configure the type of error triggered on SS1 monitored ramp violation.	● Inactive	● STO is activated and a SAVF error is triggered. This error can be reset without power cycle.
		● Active	● At the 5 th SS1 activation with monitored ramp violation, the error triggered can only be reset with a power cycle.

Safety Function SLS (Safely Limited Speed)

Overview

The safety function SLS prevents the motor from exceeding specified frequency limit. The drive limits the motor frequency between the SLS frequency limits.

Depending on the requirements, you can select, for the safety function SLS, one of the 6 types with **[SLS Type] 5 C 3 9** parameter:

- **SLS Type 1:** Limitation of the maximum reference frequency to the motor frequency reached at SLS activation and monitoring of the motor frequency to be within the specified frequency limits.
- **SLS Type 2:** Limitation of the maximum reference frequency to a fixed Set point and monitoring of the motor frequency to be within the specified frequency limits.
- **SLS Type 3:** Same as SLS type 2 with SS1 activation if the motor frequency exceeds the configured threshold value at SLS activation.
- **SLS Type 4:** Limitation of the reference frequency between fixed set points and monitoring of the motor frequency to be within the specified frequency limits. The direction of rotation can be modified while SLS is active.
- **SLS Type 5:** Same as SLS type 4 with a deceleration ramp if the motor frequency exceeds the configured threshold value at SLS activation.
- **SLS Type 6:** Same as SLS type 4 with SS1 activation if the motor frequency exceeds the configured threshold value at SLS activation.

NOTE:

- SLS limits the motor in forward (positive) direction and reverse (negative) direction. Only the parameters for the forward direction can be configured, the parameters for the reverse direction are automatically set to the same value.
- The different SLS levels (threshold, set point and standstill level) must be set within the lowest SMS thresholds.
- SLS is active if the safety module status is `Operation Enabled` and the safety-related inputs (SI_A & SI_B) assigned on **5 C 2 5** are low (0).

Behavior of the Safety Function SLS - Type 1

Limitation of the maximum reference frequency to the motor frequency reached at SLS activation and monitoring of the motor frequency to be within the specified frequency limits.

At SLS activation, in forward direction:

If the motor frequency is...	Then ...
① above [SLS Positive Threshold] 5 C 4 B	SAVF error is triggered and STO is activated.
② between [SLS Positive Threshold] 5 C 4 B and [SLS Positive Standstill Level] 5 C 4 E	The reference frequency is limited to values below the reference frequency value reached at SLS activation. The motor frequency is monitored. If the value decreases below [SLS positive standstill level] 5 C 4 E, STO is activated. If the value increases above [SLS positive threshold] 5 C 4 B, a SAVF error is triggered and STO is activated.
③ below [SLS Positive Standstill Level] 5 C 4 E	STO is activated.

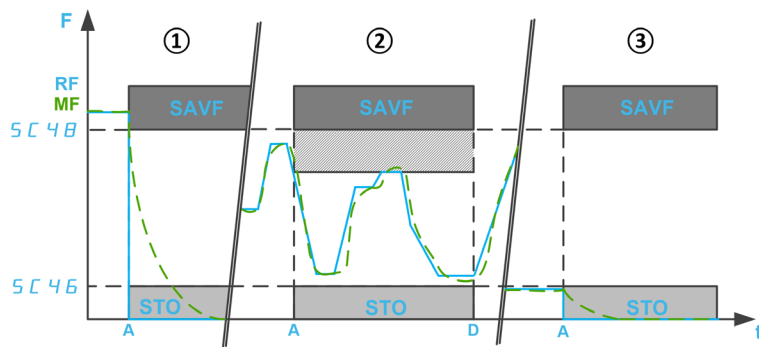

F: Frequency / RF: Reference Frequency / MF: Motor Frequency

A: SLS activation

D: SLS Deactivation

t: time

SC46: SLS Positive Standstill Level / SC48: SLS Positive Threshold

Behavior of the Safety Function SLS - Type 2

Limitation of the maximum reference frequency to a fixed set point and monitoring of the motor frequency to be within the specified frequency limits.

At SLS activation, in forward direction:

If the motor frequency is...	Then ...
① above [SLS Positive Threshold] 5 C 4 B	<p>The reference frequency decreases to the configured set point ([SLS Positive Set Point] 5 C 5 D) according to [Monitored ramp commanded deceleration] 5 C 4 D. During the deceleration, the motor frequency is monitored according to a ramp defined by:</p> <ul style="list-style-type: none"> • Its ramp: [Monitored ramp deceleration] 5 C 4 I (same value as [Monitored ramp commanded deceleration] 5 C 4 D). • Its starting point: [Monitored ramp offset] 5 C 4 E plus the motor frequency value at SLS activation. <p>If the monitoring ramp is violated, a 5 A V F error is triggered and STO is activated.</p> <p>From the configured threshold value ([SLS Positive Threshold] 5 C 4 B), if the motor frequency:</p> <ul style="list-style-type: none"> • Decreases below [SLS Positive Standstill Level] 5 C 4 E, STO is activated. • Increases above [SLS Positive Threshold] 5 C 4 B, a 5 A V F error is triggered and STO is activated. <p>If the motor frequency reaches the configured set point value ([SLS Positive Set Point] 5 C 5 D), the reference frequency is limited to values below the configured set point value. The monitoring of the motor frequency remains active.</p>
② between [SLS Positive Threshold] 5 C 4 B and [SLS Positive Set Point] 5 C 5 D	<p>The reference frequency decreases to the configured set point ([SLS Positive Set Point] 5 C 5 D) according to [Monitored ramp commanded deceleration] 5 C 4 D. The motor frequency is monitored. If the value decreases below [SLS Positive Standstill Level] 5 C 4 E, STO is activated. If the value increases above [SLS Positive Threshold] 5 C 4 B, a 5 A V F error is triggered and STO is activated.</p> <p>If the motor frequency reaches the configured set point value ([SLS Positive Set Point] 5 C 5 D), the reference frequency is limited to values below the configured set point value.</p>
③ between [SLS Positive Set Point] 5 C 5 D and [SLS Positive Standstill Level] 5 C 4 E	<p>The reference frequency is limited to values below the configured set point ([SLS Positive Set Point] 5 C 5 D). The motor frequency is monitored. If the value decreases below [SLS Positive Standstill Level] 5 C 4 E, STO is activated. If the value increases above [SLS Positive Threshold] 5 C 4 B, a 5 A V F error is triggered and STO is activated.</p>
④ below [SLS Positive Standstill Level] 5 C 4 E	<p>The temporization configured by [SLS Wait Time] 5 C 5 H is started.</p> <p>If the motor frequency reaches the [SLS Positive Standstill Level] 5 C 4 E before the end of the temporization, then</p> <ul style="list-style-type: none"> • the reference frequency is limited to values below [SLS Positive Set Point] 5 C 5 D, • the motor frequency is monitored. If the value decreases below [SLS Positive Standstill Level] 5 C 4 E, STO is activated. If the value increases above [SLS Positive Threshold] 5 C 4 B, a 5 A V F error is triggered and STO is activated. <p>else STO is activated without error triggered.</p>

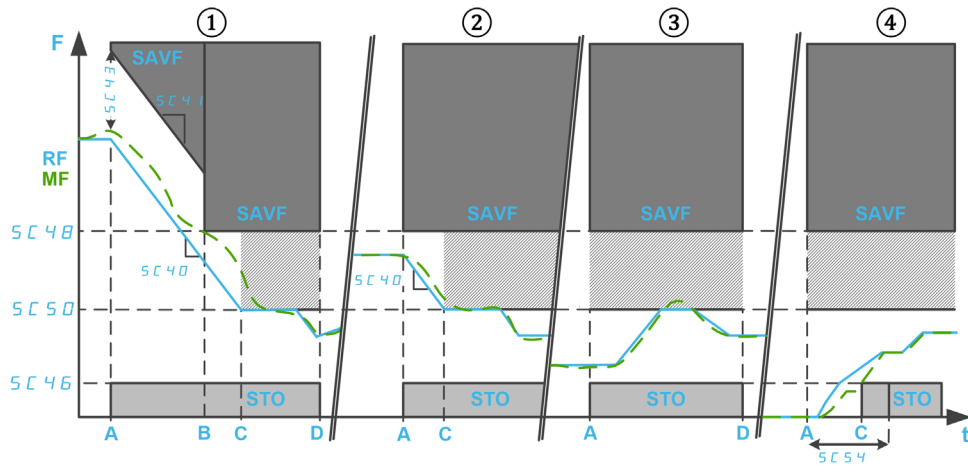

F: Frequency / **RF:** Reference Frequency / **MF:** Motor Frequency

t: time

SC46: SLS Positive Standstill Level / **SC48:** SLS Positive Threshold / **SC50:** SLS Positive Set Point

SC54: SLS Wait Time

SC40: Monitored ramp commanded deceleration / **SC41:** Monitored ramp deceleration / **SC43:** Monitored ramp offset

A: SLS activation

B: Threshold reached

C: Set Point or Standstill level reached

D: SLS Deactivation

Behavior of the Safety Function SLS - Type 3

Same as SLS type 2 with SS1 activation if the motor frequency exceeds the configured threshold value at SLS activation.

At SLS activation, in forward direction:

If the motor frequency is...	Then ...
① above [SLS Positive Threshold] 5 C 4 B	SS1 ⁽¹⁾ is activated.
② between [SLS Positive Threshold] 5 C 4 B and [SLS Positive Set Point] 5 C 5 D	The reference frequency decreases to the configured set point ([SLS Positive Set Point] 5 C 5 D) according to [Monitored ramp commanded deceleration] 5 C 4 D. The motor frequency is monitored. If the value decreases below [SLS Positive Standstill Level] 5 C 4 E, STO is activated. If the value increases above [SLS Positive Threshold] 5 C 4 B, a SAVF error is triggered and STO is activated. If the motor frequency reaches the configured set point value ([SLS Positive Set Point] 5 C 5 D), the reference frequency is limited to values below the configured set point value.
③ between [SLS Positive Set Point] 5 C 5 D and [SLS Positive Standstill Level] 5 C 4 E	The reference frequency is limited to values below the configured set point ([SLS Positive Set Point] 5 C 5 D). The motor frequency is monitored. If the value decreases below [SLS Positive Standstill Level] 5 C 4 E, STO is activated. If the value increases above [SLS Positive Threshold] 5 C 4 B, a SAVF error is triggered and STO is activated.
④ below [SLS Positive Standstill Level] 5 C 4 E	The temporization configured by [SLS Wait Time] 5 C 5 4 is started. If the motor frequency reaches the [SLS Positive Standstill Level] 5 C 4 E before the end of the temporization, then <ul style="list-style-type: none"> the reference frequency is limited to values below [SLS Positive Set Point] 5 C 5 D, the motor frequency is monitored. If the value decreases below [SLS Positive Standstill Level] 5 C 4 E, STO is activated. If the value increases above [SLS Positive Threshold] 5 C 4 B, a SAVF error is triggered and STO is activated. else STO is activated without error triggered.

(1): With SLS type 3, SS1 must be configured in Automatic mode.

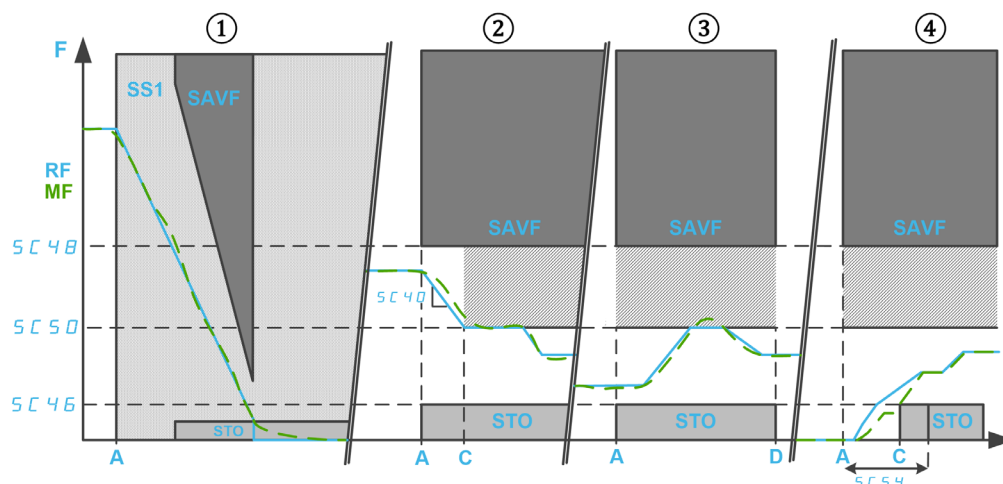

F: Frequency / RF: Reference Frequency / MF: Motor Frequency

t: Time

SC40: Monitored ramp commanded deceleration

SC46: SLS Positive Standstill Level / SC48: SLS Positive Threshold / SC50: SLS Positive Set Point

SC54: SLS Wait Time

A: SLS activation

B: Set Point or Standstill level reached

D: SLS Deactivation

Behavior of the Safety Function SLS - Type 4

Limitation of the reference frequency between fixed set points and monitoring of the motor frequency to be within the specified frequency limits. The direction of rotation can be changed while the SLS is active.

At SLS activation, in forward direction:

If the motor frequency is...	Then ...
① above [SLS Positive Threshold] 5 C 4 B	5 A V F error is triggered and STO is activated.
② between [SLS Positive Threshold] 5 C 4 B and [SLS Positive Set Point] 5 C 5 D	The reference frequency decreases to the configured set point ([SLS Positive Set Point] 5 C 5 D) according to [Monitored ramp commanded deceleration] 5 C 4 D. The motor frequency is monitored. If the value exceeds [SLS positive threshold] 5 C 4 B or [SLS negative threshold] 5 C 4 9, a 5 A V F error is triggered and STO is activated. If the motor frequency reaches the configured set point value ([SLS Positive Set Point] 5 C 5 D), the reference frequency is limited to values between the set point values. The monitoring of the motor frequency remains active.
③ below [SLS Positive Set Point] 5 C 5 D	The reference frequency is limited to values between the set point values ([SLS positive set point] 5 C 5 D and [SLS negative set point] 5 C 5 1). The motor frequency is monitored. If the value exceeds [SLS positive threshold] 5 C 4 B or [SLS negative threshold] 5 C 4 9, a 5 A V F error is triggered and STO is activated.

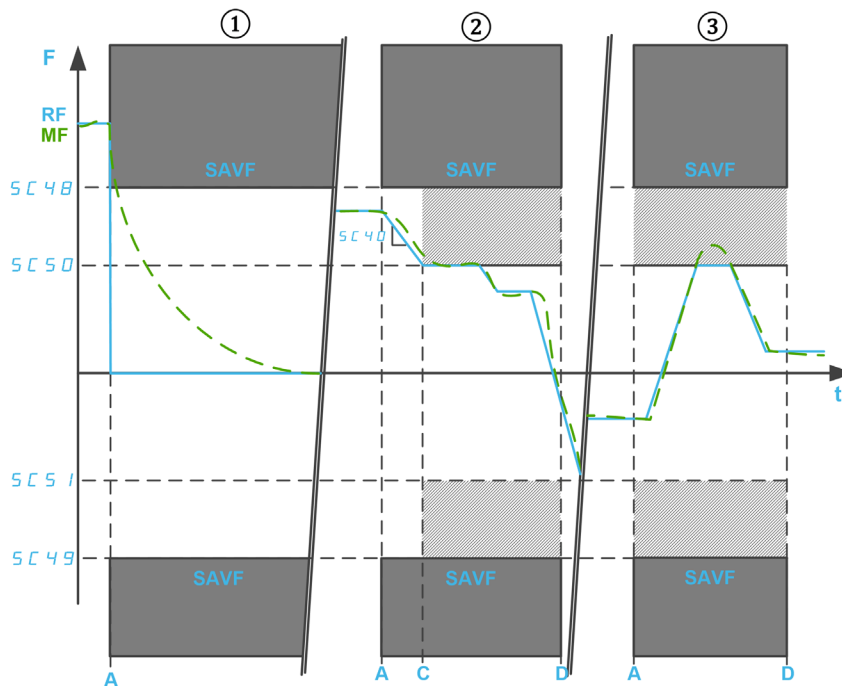

- F: Frequency / RF: Reference Frequency / MF: Motor Frequency
- t: time
- SC40: Monitored ramp commanded deceleration
- SC48: SLS Positive Threshold / SC49: SLS Negative Threshold
- SC50: SLS Positive Set Point / SC51: SLS Negative Set Point
- A: SLS activation
- C: Set Point reached
- D: SLS Deactivation

Behavior of the Safety Function SLS - Type 5

Same as SLS type 4 with a deceleration ramp if the motor frequency exceeds the configured threshold value at SLS activation.

At SLS activation, in forward direction:

If the motor frequency is...	Then ...
① above [SLS Positive Threshold] 5 C 4 B	<p>The reference frequency decreases to the configured set point ([SLS positive set point] 5 C 5 D) according to [Monitored ramp commanded deceleration] 5 C 4 D.</p> <p>During the deceleration, the motor frequency is monitored according to a ramp defined by:</p> <ul style="list-style-type: none"> • Its ramp: [Monitored ramp deceleration] 5 C 4 I (same value as [Monitored ramp commanded deceleration] 5 C 4 D). • Its starting point: [Monitored ramp offset] 5 C 4 E plus the motor frequency value at SLS activation. <p>If the monitoring ramp is violated, a SAVF error is triggered and STO is activated.</p> <p>If the motor frequency reaches the configured threshold value ([SLS positive threshold] 5 C 4 B), the motor frequency is monitored. If the value exceeds [SLS positive threshold] 5 C 4 B or [SLS negative threshold] 5 C 4 G, a SAVF error is triggered and STO is activated.</p> <p>If the motor frequency reaches the configured set point value ([SLS Positive Set Point] 5 C 5 D), the motor frequency remains monitored and the reference frequency is limited to values between the set point values ([SLS Positive Set Point] 5 C 5 D and [SLS negative set point] 5 C 5 I).</p>
② between [SLS Positive Threshold] 5 C 4 B and [SLS Positive Set Point] 5 C 5 D	<p>The reference frequency decreases to the configured set point ([SLS Positive Set Point] 5 C 5 D) according to [Monitored ramp commanded deceleration] 5 C 4 D.</p> <p>The motor frequency is monitored. If the value exceeds [SLS positive threshold] 5 C 4 B or [SLS negative threshold] 5 C 4 G, a SAVF error is triggered and STO is activated.</p> <p>If the motor frequency reaches the configured set point value ([SLS Positive Set Point] 5 C 5 D), the reference frequency is limited to values between the set point values. The monitoring of the motor frequency remains active.</p>
③ below [SLS Positive Set Point] 5 C 5 D	<p>The reference frequency is limited to values between the set point values ([SLS positive set point] 5 C 5 D and [SLS negative set point] 5 C 5 I).</p> <p>The motor frequency is monitored. If the value exceeds [SLS positive threshold] 5 C 4 B or [SLS negative threshold] 5 C 4 G, a SAVF error is triggered and STO is activated.</p>

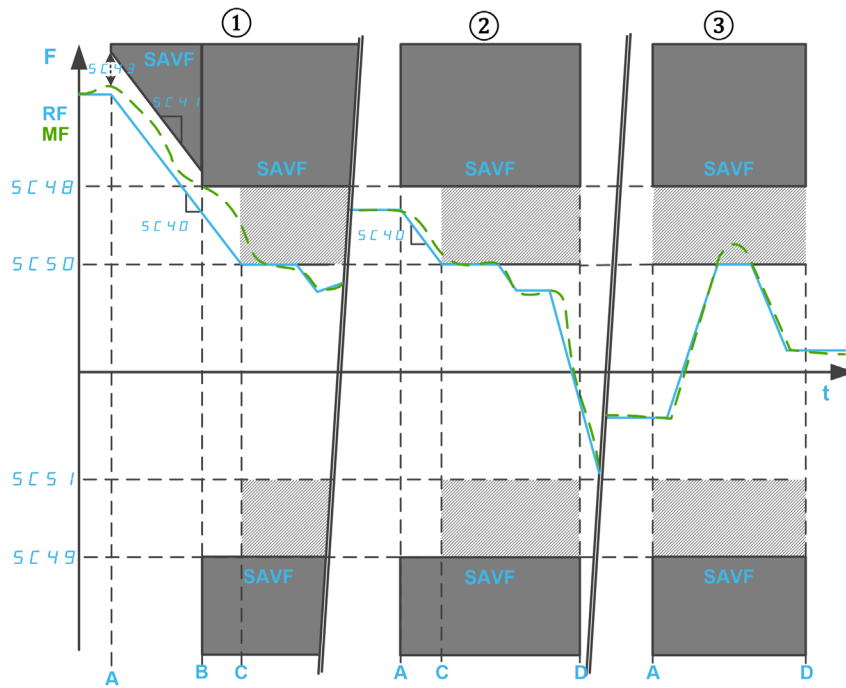

F: Frequency / **RF:** Reference Frequency / **MF:** Motor Frequency

t: time

SC48: SLS Positive Threshold / **SC49:** SLS Negative Threshold

SC50: SLS Positive Set Point / **SC51:** SLS Negative Set Point

SC40: Monitored ramp commanded deceleration

SC41: Monitored ramp deceleration / **SC43:** Monitored ramp offset

A: SLS activation

B: Threshold reached

C: Set Point reached

D: SLS Deactivation

Behavior of the Safety Function SLS - Type 6

Same as SLS type 4 with SS1 activation if the motor frequency exceeds the configured threshold value at SLS activation.

At SLS activation, in forward direction:

If the motor frequency is...	Then ...
① above [SLS Positive Threshold] 5 C 4 B	SS1 ⁽¹⁾ is activated.
② between [SLS Positive Threshold] 5 C 4 B and [SLS Positive Set Point] 5 C 5 D	The reference frequency decreases to the configured set point ([SLS Positive Set Point] 5 C 5 D) according to [Monitored ramp commanded deceleration] 5 C 4 D. The motor frequency is monitored. If the value exceeds [SLS positive threshold] 5 C 4 B or [SLS negative threshold] 5 C 4 9, a SAVF error is triggered and STO is activated. If the motor frequency reaches the configured set point value ([SLS Positive Set Point] 5 C 5 D), the reference frequency is limited to values between the set point values. The monitoring of the motor frequency remains active.
③ below [SLS Positive Set Point] 5 C 5 D	The reference frequency is limited to values between the set point values ([SLS positive set point] 5 C 5 D and [SLS negative set point] 5 C 5 I). The motor frequency is monitored. If the value exceeds [SLS positive threshold] 5 C 4 B or [SLS negative threshold] 5 C 4 9, a SAVF error is triggered and STO is activated.

(1): With SLS type 6, SS1 must be configured in Automatic mode.

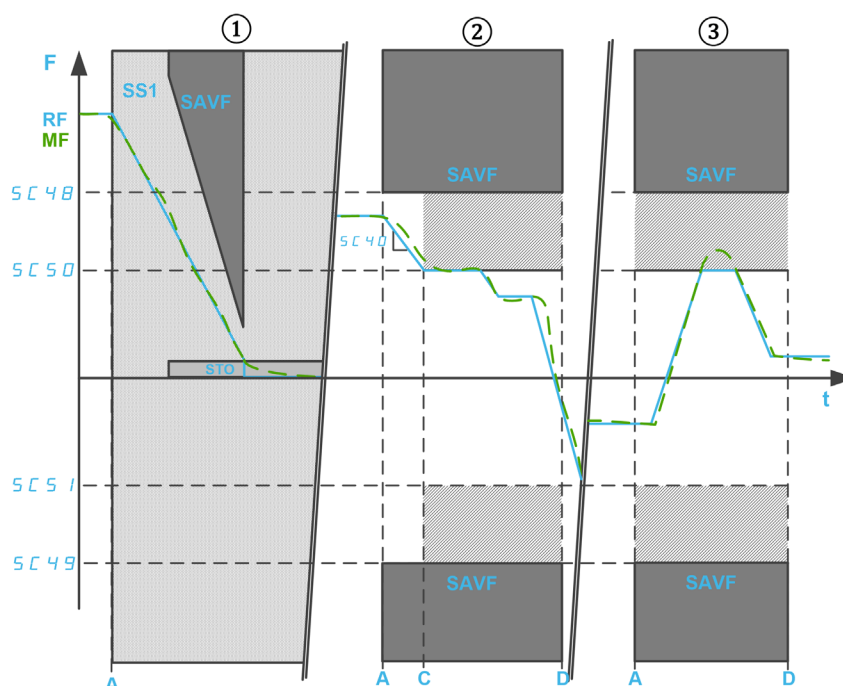

F: Frequency / RF: Reference Frequency / MF: Motor Frequency

t: time

SC40: Monitored ramp commanded deceleration

SC48: SLS Positive Threshold / SC49: SLS Negative Threshold

SC50: SLS Positive Set Point / SC51: SLS Negative Set Point

A: SLS activation

C: Set Point reached

D: SLS Deactivation

Safety function SLS parameters

The following table gives the list of parameters for the safety function SLS:

Parameter	Description	Possible values	Description
[SLS input assignment] 5 C 2 5	Safety-related input (dual channel) to activate the safety function SLS.	<ul style="list-style-type: none"> ● Not assigned ● SI1 ● SI2 ● SI3 ● SI4 	<ul style="list-style-type: none"> ● Not assigned ● Assigned to SI1_A and SI1_B ● Assigned to SI2_A and SI2_B ● Assigned to SI3_A and SI3_B ● Assigned to SI4_A and SI4_B
[SLS Type] 5 C 3 9	The type of the safety function SLS.	<ul style="list-style-type: none"> ● Undefined ● SLS Type 1 ● SLS Type 2 ● SLS Type 3 ⁽¹⁾ ● SLS Type 4 ● SLS Type 5 ● SLS Type 6 ⁽¹⁾ 	See the overview for SLS types information. If SLS is assigned to an input of the safety module, this parameter must be set to a value different from Undefined.
[Monitored ramp commanded deceleration] 5 C 4 0	Deceleration command ramp used when the motor frequency is greater than [SLS Positive set point] 5 C 5 0 or less than [SLS Negative set point] 5 C 5 1.	<ul style="list-style-type: none"> ● Undefined ● 0.1...20,000 Hz/s Step: 0.1 Hz/s	Setting range.
[Monitored ramp deceleration] 5 C 4 1	Deceleration monitoring ramp used when the motor frequency is greater than [SLS Positive Threshold] 5 C 4 B or less than [SLS Negative Threshold] 5 C 4 9 at SLS activation. Only used with SLS type 2 and SLS type 5.	<ul style="list-style-type: none"> ● Undefined ● 0.1...20,000 Hz/s Step: 0.1 Hz/s	Read-only parameter. Defined with [Monitored ramp commanded deceleration] 5 C 4 0
[SLS Frequency Offset] 5 C 4 3	Added offset value for the monitored ramp.	0...200.0 Hz Step: 0.1 Hz	Setting range.
[SLS Positive Standstill Level] 5 C 4 6 ⁽²⁾	STO activation level in forward direction.	<ul style="list-style-type: none"> ● Inactive ● 0.1...200.0 Hz/s Step: 0.1 Hz/s	Setting range.
[SLS Negative Standstill Level] 5 C 4 7 ⁽²⁾	STO activation level in reverse direction.	<ul style="list-style-type: none"> ● Inactive ● 0.1...200.0 Hz/s Step: 0.1 Hz/s	Read-only parameter. Configured via [SLS Positive Standstill Level] 5 C 4 6
[SLS Positive Threshold] 5 C 4 B ⁽²⁾	High limit of the motor frequency monitoring in forward direction.	0...200.0 Hz Step: 0.1 Hz	Setting range.
[SLS Negative Threshold] 5 C 4 9 ⁽²⁾	High limit of the motor frequency monitoring in reverse direction.	0...200.0 Hz Step: 0.1 Hz	Read-only parameter. Configured via [SLS Positive Threshold] 5 C 4 B
[SLS Positive Set Point] 5 C 5 0 ⁽²⁾	Maximum reference frequency in forward direction.	0...200.0 Hz Step: 0.1 Hz	Setting range.
[SLS Negative Set Point] 5 C 5 1 ⁽²⁾	Maximum reference frequency in reverse direction.	0...200.0 Hz Step: 0.1 Hz	Read-only parameter. Configured via [SLS positive set point] 5 C 5 0
[SLS Wait Time] 5 C 5 4	Delay at SLS activation within the motor frequency can remain inside the standstill level.	<ul style="list-style-type: none"> ● Inactive ● 0...65,535ms Step: 1 ms	Setting range.
(1): This setting requires to configure the safety function SS1 in automatic mode.			
(2): This parameter must be configured to a value greater than the minimum observable frequency.			

The following table gives the list of parameters used for each type of the safety function SLS:

Parameter						
[SLS input assignment] 5C25	To be configured to a value different from Not Assigned					
[SLS Type] 5C39	SLS Type 1	SLS Type 2	SLS Type 3 ⁽²⁾	SLS Type 4	SLS Type 5	SLS Type 6 ⁽²⁾
[Monitored ramp commanded deceleration] 5C40	-	To be configured				
[Monitored ramp deceleration] 5C41	-	Equal to 5C40 ⁽¹⁾	-	-	Equal to 5C40 ⁽¹⁾	-
[Monitored ramp offset] 5C43	-	Recommendation: Equal to or greater than the maximum motor frequency overshoot plus 5C04.	-	-	Recommendation: Equal to or greater than the maximum motor frequency overshoot plus 5C04.	-
[SLS Positive Standstill Level] 5C46	To be configured to a value equal to or less than 5C48	To be configured to a value equal to or less than 5C50		-		
[SLS Negative Standstill Level] 5C47	Equal to 5C46 ⁽¹⁾			-		
[SLS Positive Threshold] 5C48 ⁽³⁾	To be configured to a value equal to or greater than 5C46	To be configured to a value equal to or greater than 5C50.				
[SLS Negative Threshold] 5C49 ⁽³⁾	Equal to 5C48 ⁽¹⁾					
[SLS Positive Set Point] 5C50 ⁽²⁾	-	To be configured between 5C46 and 5C48 (included)		To be configured to a value equal to or less than 5C48.		
[SLS Negative Set Point] 5C51 ⁽²⁾	-	Equal to 5C50 ⁽¹⁾				
[SLS Wait Time] 5C54	-	To be configured		-		
(1): Fixed setting value. (2): This setting requires to configure the safety function SS1 in automatic mode. (3): If SMS is configured, SLS thresholds must be set within the lowest SMS thresholds.						

Safety Function SBC (Safe Brake Control)

Overview

⚠ WARNING

EXCESSIVE MECHANICAL CONSTRAINTS

When the safety function STO is triggered, the power stage is immediately disabled and the brake is applied. In the case of external forces acting on the motor shaft, you may have to verify that the brake and all the equipment involved in the movement are correctly chosen to be able to stop the movement at full load and at full speed of the application.

Failure to follow these instructions can result in death, serious injury, or equipment damage.

The safety function SBC is not synchronized with the Brake Logic Control function of the drive (BLC). They are two different functions controlling different brakes:

- The brake device used for Brake Logic Control is a service brake. For information on the Brake Logic Control refer to the programming manual of the drive (see page 12)
- The brake device used for Safe Brake Control (SBC) is either a safe brake or two brakes used in parallel.

The safety function SBC provides a safety output signal to control an external relay in order to control external brakes. The safety output used with the safety function SBC is SQ1 (channel A and B).

SBC is used in combination of other safety functions of the safety module such as SS1..

To enable the safety function SBC, you must set [SQ1A/B function assignment] 5 C 1 B to SBC no torque after SS1. The other setting values of [SQ1A/B function assignment] 5 C 1 B are not linked to SBC function refer to Output SQ1 function (see page 80).

The safety function SBC can be used in combination of SBC feedback monitoring. To activate the SBC feedback monitoring, you must set [SI7 function assignment] 5 C 1 3 to SBC Feedback.

NOTE: The SBC feedback monitoring does not improve the reliability and the SIL/PL level of the safety function SBC.

Depending on your needs, the SBC feedback signal can be chained by assigning the safety output SQ3 to the SBC feedback monitoring ([SQ3 function assignment] 5 C 1 2 = SBC Feedback). In this case, the signal of the output SQ3 is directly copied from the signal of the input SI7.

Example of SBC wiring diagrams

Wiring of a safety brake

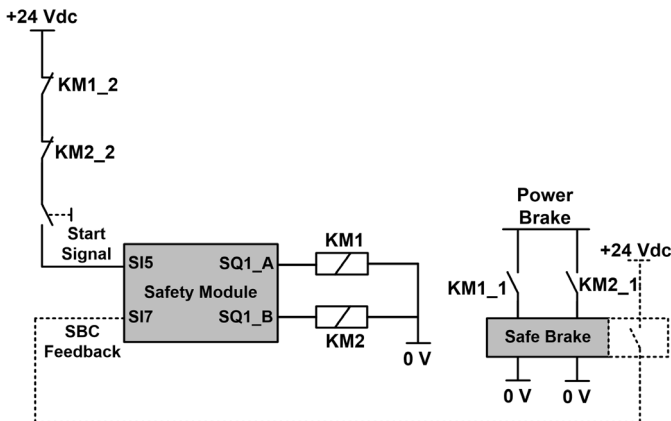

SBC feedback signal (dotted line) is an optional signal.

The wiring of KM1_2 (or KM2_2) contact on the start signal helps to prevent the start of the safety module in case of welding contacts on the relay KM1 (or KM2) if KM1_2 and KM1_1 (or KM2_2 and KM2_1) are mechanically linked.

Wiring of two brakes

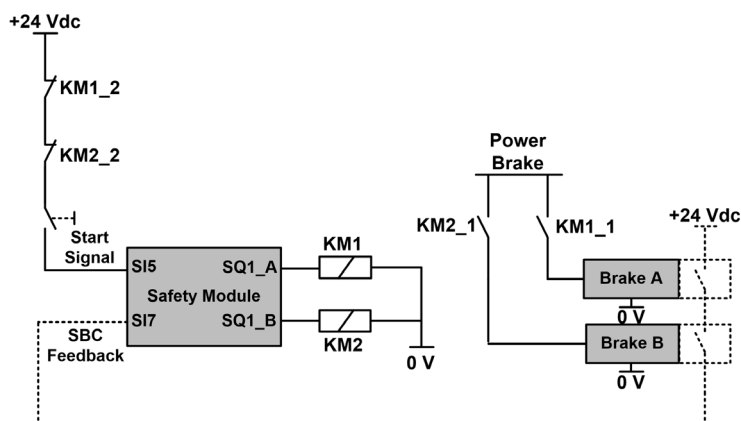

SBC feedback signal (dotted line) is an optional signal. The wiring of KM1_2 (or KM2_2) contact on the start signal helps to prevent the start of the safety module in case of welding contacts on the relay KM1 (or KM2) if KM1_2 and KM1_1 (or KM2_2 and KM2_1) are mechanically linked.

Chaining the SBC feedback signal

The following figure shows an example of SBC feedback wiring with 3 safety modules (SM1, SM2 and SM5) connected to the terminal adapter:

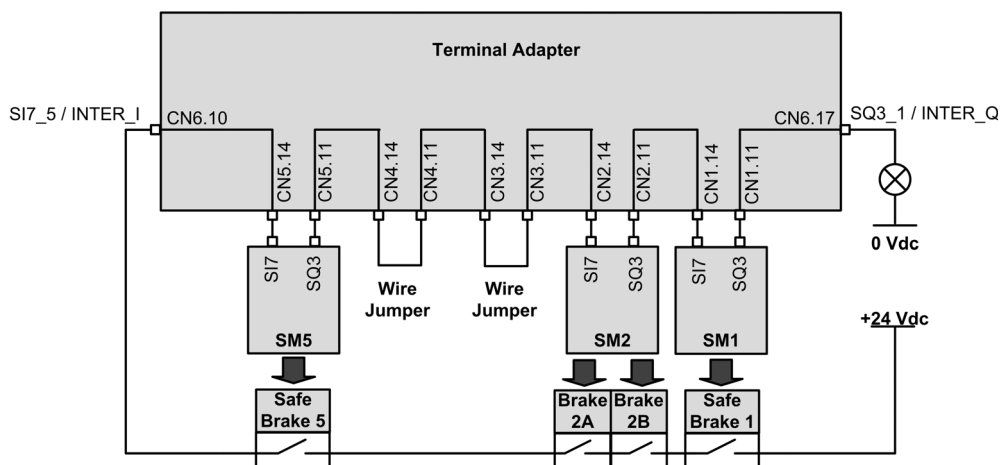

Both [SQ3 function assignment] 5 C 12 and [SI7 function assignment] 5 C 13 of each chained safety module are set to SBC Feedback.

The output SQ3_1 / INTER_Q is at high-level if each brake is released.

Behavior of the Safety Function SBC

The safety module releases of the safe brake when the safety module switches in the operating state Operation Enabled (see ①).

The safety module applies the brake if one of the following events occur:

- ② **SS1 is requested (by input) or activated (by another safety function or via a detected error class 2):**
At SS1 standstill level, the safe brake is applied after a time defined by [SBC engage delay] 5 C 6 3. During this delay, the operating state shown by the drive remains SS1.
- ③ **Activation of STO (such as on SLS standstill level, on the detection of an error class 3 or 4):** the command to apply the brake is immediately requested.

The command to apply the brake corresponds to the low level of the safety output SQ1 (0). The command to release the brake corresponds to the high level of the safety output SQ1 (1).

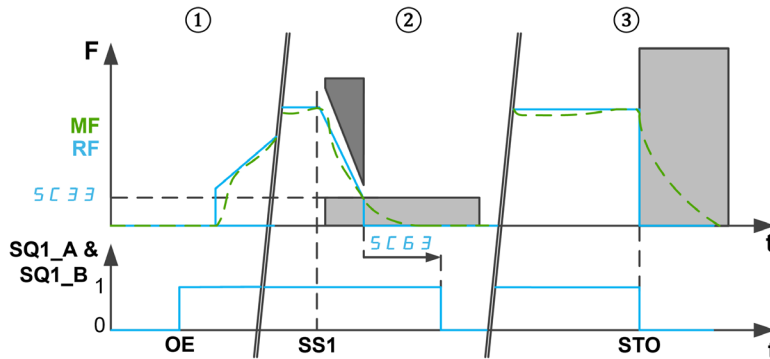

F: Frequency / MF: Motor Frequency / RF: Reference Frequency

t: time

SQ1_A & SQ1_B: Safety-Related output SQ1 (dual channel)

SC33: SS1 Standstill level

SC63: SBC engage delay

OE: Safety module in Operation Enabled

SS1: SS1 activated or requested

STO: Activation of STO

NOTE:

- At SS1 activation, during the time [SS1 delay before monitoring] 5 C 3 4, no command to apply the brake is requested. The state of the safety output SQ1 remains unchanged.
- If the 24 Vdc supply voltage of the module is removed, the safety output SQ1 is disabled, the command to apply the brake is requested.
- Stop requests of the drive (such as freewheel stop) does not apply the safe brake.
- With Auto/level start signal, after SS1 (see page 49) the power stage is locked. If the source of SS1 activation has been deactivated before its completion (i.e. before the end of [SBC engage delay] 5 C 6 3), there is still a command to apply the brake during 100 ms (brake is released automatically), then the power can be enabled again by the drive.

Behavior of the SBC Feedback Monitoring

The SBC feedback monitoring is an additional feature of SBC function. This function monitors the state of the safe brake. In case of inconsistency, an error class 3 is triggered.

On the input SI7, the high-level state (1) corresponds to a released brake. A brake applied corresponds to a low level (0).

The monitoring of the SBC feedback is done as following:

- After a command to release the brake,
 - ① If the brake feedback signal shows a brake applied (low-level), the monitoring of the feedback is active after **[SBC Feedback delay] SC64**. During this time, the monitoring remains disabled.
 - ② If the brake feedback signal shows a brake released (high-level), the monitoring is immediately activated.
- ③ While the brake is released, the monitoring is active. If the brake feedback shows an application of the safe brake (e.g. the state of the brake feedback switches from high-level to low-level), the error class 3 is triggered.
- ④&⑤ Once the command to apply the brake is activated (at SS1 standstill level and after **[SBC engage delay] SC63** in case of SS1 or at STO activation), the monitoring of the brake is immediately disabled.

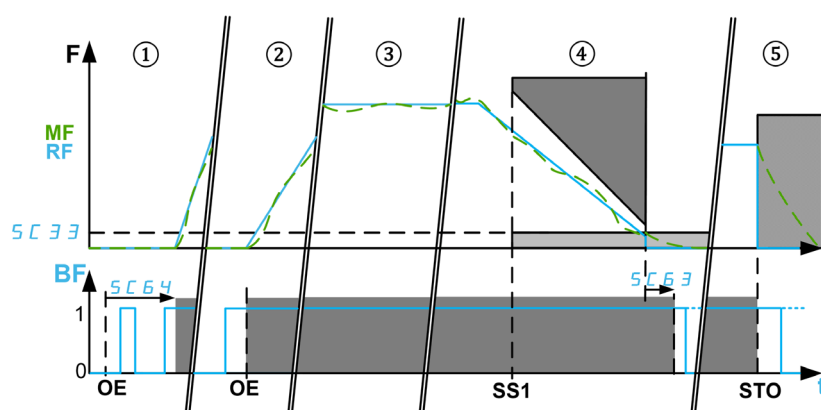

F: Frequency / **MF:** Motor Frequency / **RF:** Reference Frequency

BF: SBC Feedback / **t:** time

SC33: SS1 standstill level / **SC63:** SBC engage delay / **SC64:** SBC Feedback Delay

OE: Safety module in operating state Operation Enabled: command to release the safe brake.

SS1: Activation of SS1 / **STO:** Activation of STO such as Error Class 3 and 4 or on SLS standstill level (except via SS1)

Safety function SBC parameters

Parameter	Description	Possible values	Description
[SQ1A/B function assignment] 5 C 1 B	Configure the function available on the output SQ1. The safety output is deactivated (low level) on the occurrence of the configured event. NOTE: Irrespective of the configuration, if STO is activated, the safety output is immediately deactivated.	<ul style="list-style-type: none"> • No delay after SS1 activation • Delay after SS1 activation • SS1 standstill • SBC no torque after SS1 	<ul style="list-style-type: none"> • At SS1 activation • At SS1 activation, after the delay [SQ1A/B delay after SS1 activation] 5 C 1 9. • At SS1 standstill level reached. • Safety function SBC: at SS1 standstill level, brake engage command after [SBC engage delay] 5 C 6 3.
[SBC engage delay] 5 C 6 3	Configure the delay to apply the brake when SS1 standstill level is reached. NOTE: This parameter can be configured if [SQ1A/B function assignment] 5 C 1 B is set to SBC no torque after SS1.	0...10,000 ms Step: 1 ms	Setting range.
[SI7 function assignment] 5 C 1 3	Configure the function on the input SI7. This parameter can be set to SBC Feedback if [SQ1A/B function assignment] 5 C 1 B is set to SBC no torque after SS1. NOTE: If not assigned, the input must remain to 0V, else an error is triggered.	<ul style="list-style-type: none"> • Not Assigned • SBC Feedback • Guard Door Lock 	<ul style="list-style-type: none"> • Not assigned • Monitoring of the brake feedback • Guard door lock input to chain the signal
[SBC Feedback delay] 5 C 6 4	Configure the delay after which the brake feedback signal is monitored during the transient phase. This parameter can be assigned if [SI7 function assignment] 5 C 1 3 is set to SBC Feedback.	<ul style="list-style-type: none"> • Undefined • 1...65,535 ms Step: 1 ms	Setting range.
[SQ3 function assignment] 5 C 1 2	Configure the function on the output SQ3. This parameter can be set to SBC Feedback if [SI7 function assignment] 5 C 1 3 is set to SBC Feedback.	<ul style="list-style-type: none"> • Not Assigned • SBC Feedback • Guard Door Lock 	<ul style="list-style-type: none"> • Not Assigned • Chaining of the brake feedback • Guard door lock command

Safety Function SMS (Safe Maximum Speed)

Overview

The safety function SMS prevents the motor frequency from exceeding the specified safe maximum frequency limits.

Depending on the requirements, you can select, for the safety function SMS, one of the 3 modes with **[SMS function mode] 5 C 5 B** parameter:

- **1 threshold:** One safe maximum frequency limit for each direction.
- **2 thresholds:** Two safe maximum frequency limits for each direction. A safety-related input is used to switch from one safe maximum frequency limit to the other.
- **Activated by Safety Input:** One safe maximum frequency limit for each direction activated via a safety-related input.

Note

- The SMS function does not adjust the frequency reference value.
The frequency reference value should be adjusted via the active reference channel in order to remain within the boundaries defined by the safe maximum frequency limits.
- The lowest SMS thresholds must be set in order to include the different SLS levels (threshold, set point and standstill level).

Behavior of The Safety Function SMS with 1 threshold

One safe maximum frequency limit for each direction.

The safety function SMS is active when the safety module switches in the operating state *Operation Enabled*. While the function is active, if the motor frequency exceeds one of the specified safe maximum frequency limits (parameters **[SMS positive threshold 1] 5 C 5 7** or **[SMS negative threshold 1] 5 C 5 B**) a reaction is applied according to **[SMS violation response] 5 C 5 1**.

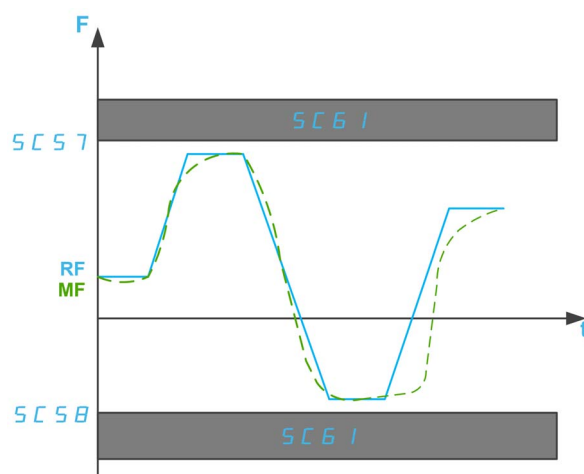

F: Frequency

RF: Reference Frequency

MF: Motor Frequency

t: time

SC57: SMS positive threshold 1

SC58: SMS negative threshold 1

SC61: SMS Violation Response

Behavior of The Safety Function SMS with 2 thresholds

Two safe maximum frequency limits for each direction. A safety-related input is used to switch from one safe maximum frequency limit to the other.

The safety function SMS is active when the safety module switches in the operating state *Operation Enabled*. While the function is active:

- If the safety-related inputs (SI_A & SI_B) assigned on [SMS Switching input assignment] 5 C 2 B are high (1) and the motor frequency exceeds one of the specified safe maximum frequency limits (parameters [SMS positive threshold 1] 5 C 5 7 or [SMS negative threshold 1] 5 C 5 B) then a reaction is applied according to [SMS violation response] 5 C 5 I.
- If the safety-related inputs (SI_A & SI_B) assigned on [SMS Switching input assignment] 5 C 2 B are low (0) and the motor frequency exceeds one of the specified safe maximum frequency limits (parameters [SMS positive threshold 2] 5 C 5 9 or [SMS negative threshold 2] 5 C 5 D) then a reaction is applied according to [SMS violation response] 5 C 5 I.

[SMS positive threshold 2] 5 C 5 9 must be equal to or less than [SMS positive threshold 1] 5 C 5 7 and [SMS negative threshold 2] 5 C 5 D must be equal to or less than [SMS negative threshold 1] 5 C 5 B.

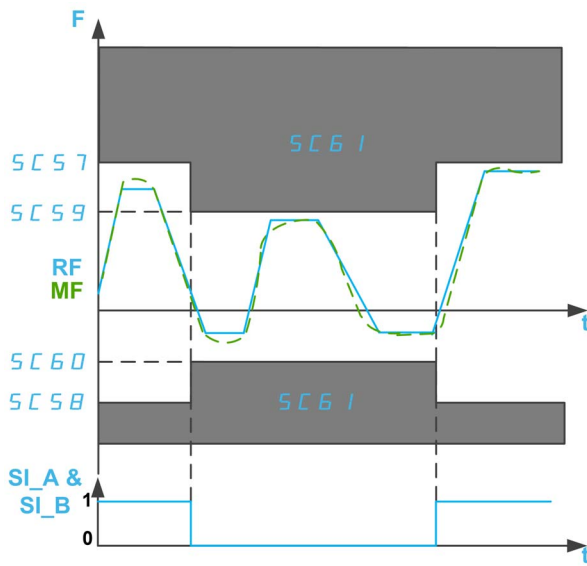

- F: Frequency
- RF: Reference Frequency
- MF: Motor Frequency
- t: time
- SI_A & SI_B: Dual Safety-Related Input (channel A & B)
- SC57: SMS positive threshold 1
- SC58: SMS negative threshold 1
- SC59: SMS positive threshold 2
- SC60: SMS negative threshold 2
- SC61: SMS Violation threshold

Behavior of The Safety Function SMS with Activated by Safety Input

One safe maximum frequency limit activated via a safety-related input.

The safety function SMS can be activated when the safety module switches in the operating state Operation Enabled:

- If the safety-related inputs (SI_A & SI_B) assigned on [SMS Switching input assignment] 5 C 2 B are high (1), the safety function SMS is deactivated: the motor frequency is not monitored.
- If the safety-related inputs (SI_A & SI_B) assigned on [SMS Switching input assignment] 5 C 2 B are low (0) and the motor frequency exceeds one of the specified safe maximum frequency limits (parameters [SMS positive threshold 1] 5 C 5 7 or [SMS negative threshold 1] 5 C 5 B) then a reaction is applied according to [SMS violation response] 5 C 6 1.

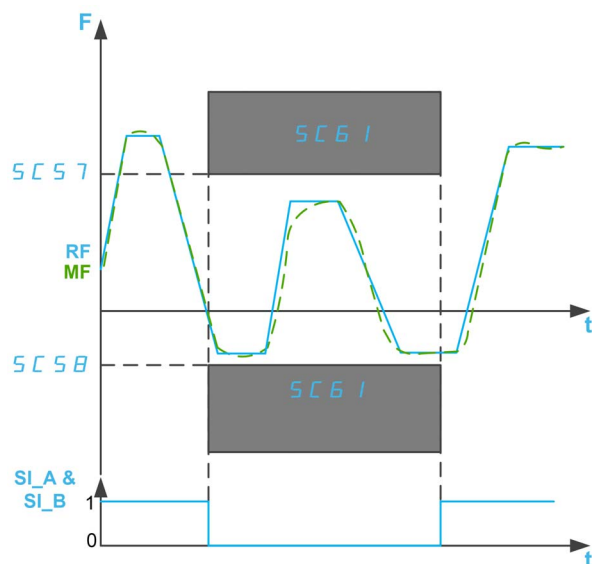

F: Frequency

RF: Reference Frequency

MF: Motor Frequency

t: time

SI_A & SI_B: Dual Safety-Related Input (channel A & B)

SC57: SMS positive threshold 1

SC58: SMS negative threshold 1

SC61: SMS Violation Response

Safety Function SMS Parameters

The following table gives the list of parameters for the safety function SMS:

Parameter	Description	Possible values	Description
[SMS function mode] 5 C 5 B	Allows you to select the mode of the safety function SMS.	<ul style="list-style-type: none"> Function inactive 1 threshold 2 thresholds Activated by Safety Input 	<ul style="list-style-type: none"> Function not used. One safe maximum frequency limit for each direction. Two safe maximum frequency limits for each direction. One safe maximum frequency limit activated via a safety-related input.
[SMS Switching input assignment] 5 C 2 B	Depending on [SMS function mode] 5 C 5 B, it allows you to assign a safety-related inputs (dual channel) to switch or activate safe maximum frequency limits.	<ul style="list-style-type: none"> Not assigned SI1 SI2 SI3 SI4 	<ul style="list-style-type: none"> Not assigned. Assigned to SI1_A and SI1_B Assigned to SI2_A and SI2_B Assigned to SI3_A and SI3_B Assigned to SI4_A and SI4_B
[SMS positive threshold 1] 5 C 5 7 ⁽¹⁾	Configure the safe maximum frequency limit 1 in positive direction.	0...200.0 Hz Step: 0.1 Hz	Setting range.
[SMS negative threshold 1] 5 C 5 B ⁽¹⁾	Configure the safe maximum frequency limit 1 in negative direction. NOTE: The frequency limit considered is the negative value.	0...200.0 Hz Step: 0.1 Hz	Setting range.
[SMS positive threshold 2] 5 C 5 9 ⁽¹⁾	Configure the safe maximum frequency limit 2 in positive direction.	0...200.0 Hz Step: 0.1 Hz	Setting range. [SMS positive threshold 2] 5 C 5 9 must be equal to or less than [SMS positive threshold 1] 5 C 5 7.
[SMS negative threshold 2] 5 C 5 D ⁽¹⁾	Configure the safe maximum frequency limit 2 in negative direction. NOTE: The frequency limit considered is the negative value.	0...200.0 Hz Step: 0.1 Hz	Setting range. [SMS negative threshold 2] 5 C 5 D must be equal to or less than [SMS negative threshold 1] 5 C 5 B.
[SMS violation response] 5 C 6 1	Allows you to configure the reaction to a frequency limit violation.	<ul style="list-style-type: none"> SS1 with Error STO with Error 	<ul style="list-style-type: none"> The safety function SS1 is activated. When the SS1 standstill is reached, STO is activated and SAVF error is triggered. STO is activated and SAVF error is triggered.

(1): This parameter must be configured to a value greater than the minimum observable frequency.

The following table gives the list of parameters used for each mode of the safety function SMS:

Parameter			
[SMS function mode] 5 C 5 B	1 threshold	2 thresholds	Activated by Safety Input
[Switching input assignment] 5 C 2 B	Not assigned	Different from Not assigned	
[SMS positive threshold 1] 5 C 5 7 ⁽¹⁾	To be configured		

(1): If SLS is configured, SLS thresholds must be set within the lowest SMS thresholds

Parameter			
[SMS negative threshold 1] 5 C 5 B ⁽¹⁾	To be configured		
[SMS positive threshold 2] 5 C 5 G ⁽¹⁾	-	To be configured to a value equal to or less than 5 C 5 7	-
[SMS negative threshold 2] 5 C 5 D ⁽¹⁾	-	To be configured to a value equal to or less than 5 C 5 B	-
[SMS violation response] 5 C 5 I	To be configured		
(1): If SLS is configured, SLS thresholds must be set within the lowest SMS thresholds			

Safety Function GDL (Guard Door Locking)

Overview

The safety function GDL does not monitor the state of the guard door. This means that the machine can be restarted while the guard door is open even though the lock is closed.

⚠ WARNING

INSUFFICIENT AND/OR INEFFECTIVE SAFETY FUNCTION

- Verify that the operation of the function is properly covered in your risk assessment.
- Verify that using this function does not compromise or reduce the Safety Integrity Level (SIL), Performance Level (PL) and/or any other safety-related requirements and capabilities defined for your machine or process.
- Ensure that all necessary organizational measures are taken (such as, but not limited to, operator training, efficient access control to manually operated equipment, or hazard signs) with regard to closing the guard door before a restart of the machine or process.

Failure to follow these instructions can result in death, serious injury, or equipment damage.

The safety function GDL releases the guard door lock via the safety module after a specified delay starting when the motor power is turned off.

Set **[SQ3 function assignment] 5 C 1 2** to *Guard Door Lock* in order to enable the safety function GDL. The safety output SQ3 of the safety module must be connected to the lock of the guard door.

In addition, by setting **[SI7 function assignment] 5 C 1 3** to *Guard Door Lock*, the safety function GDL considers the status of the safety input SI7 (Interlock_IN) before releasing the guard door lock. This safety input can be used to chain the guard door lock signal.

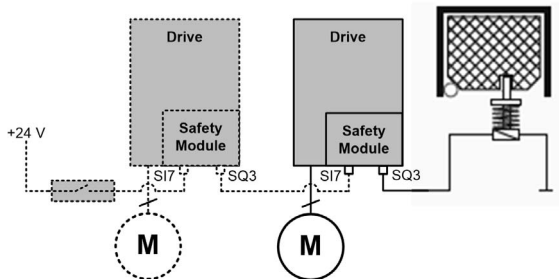

NOTE: The behavior of GDL function is not impacted by the setting *SBC Feedback* of **[SI7 function assignment] 5 C 1 3**.

Behavior of The Safety Function GDL

The figure below shows the behavior of the output controlling the guard door lock according to the type of stop and the safety input SI7 if configured to Guard Door Lock:

- ① Behavior of GDL without signal chaining,
- ② Behavior of GDL with signal chaining (SI7 is assigned to Guard Door Lock).

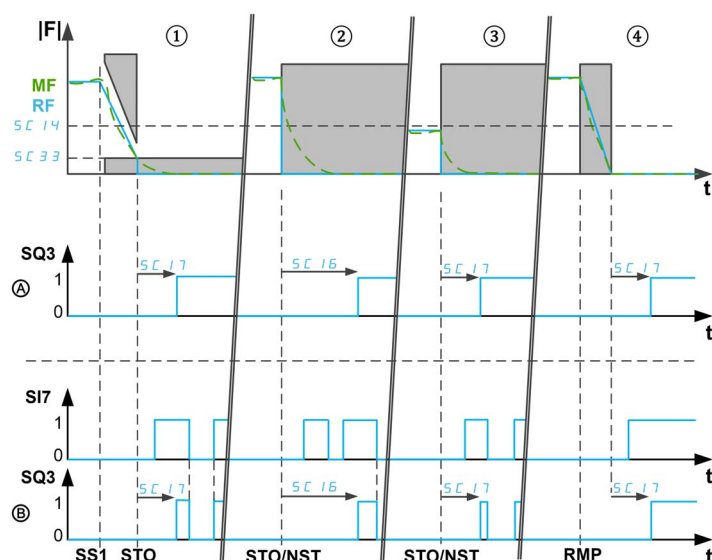

|F|: Frequency (Absolute value) / **RF**: Reference Frequency / **MF**: Motor Frequency

t: time

SQ3: Safety Output 3 (Interlock Out) - 0: Closing command / 1: Opening command

SI7: Safety Input 7 (Interlock IN) - 0: Close Lock request / 1: Open lock possible

SC 14: GDL Unlocking Frequency / **SC 33**: SS1 Standstill level

SC 16: GDL long delay / **SC 17**: GDL short delay

SS1: SS1 Activation

STO/NST: STO activation / stop in freewheel

RMP: Ramp stop activation

If the safety function GDL is enabled (SQ3 is assigned to Guard Door Lock), the closing command of the guard door lock is applied once the power stage can be enabled by the drive (i.e. the safety module is in the operating state *Operation Enabled*).

NOTE: After a power-on of the safety module, the closing command of the guard door lock remains applied during **[GDL long delay] SC 16** then if the power stage remains locked by the safety module, the closing command remains active else an opening command is applied.

The opening command of the guard door lock is applied:

- ① After **[GDL short delay] SC 17** at SS1 standstill level reached if SS1 is activated (or an error class 2 is triggered). If **[SS1 Standstill Level] SC 33** is equal to or greater than **[GDL unlocking frequency] SC 14**, the delay applied is **[GDL long delay] SC 16**.
- ② After **[GDL long delay] SC 16** if an uncontrolled stop request (such as STO or freewheel stop) is activated with a motor frequency greater than **[GDL unlocking frequency] SC 14**,
- ③ After **[GDL short delay] SC 17** if an uncontrolled stop request is activated with a motor frequency equal to or less than **[GDL unlocking frequency] SC 14**,
- ④ After **[GDL short delay] SC 17** at PWM deactivation if a controlled stop (such as ramp stop or fast stop) is requested.

Note:

- If a minimum observable frequency error is detected, the opening command of the guard door lock is applied after **[GDL long delay] 5 C 15**. In case of the detection of another error class 3, the opening command is applied after a delay depending on the motor frequency. If the error class 4 is detected, the lock of the guard door remains closed.
- The opening command of the guard door lock corresponds to the high level of the safety output SQ3 (1). The closing command of the guard door lock corresponds to the low level of the safety output SQ3 (0).
- If the 24 V supply voltage of the module is removed, the safety output SQ3 is disabled corresponding to a closing command of the guard door lock.
- **[GDL long delay] 5 C 15** and **[GDL short delay] 5 C 17** must be defined in accordance with the characteristics of the machine. For example, **[GDL long delay] 5 C 15** must be equal to or greater than the time for the motor to stop from the maximum frequency with an uncontrolled stop.

If **[SI7 function assignment] 5 C 13** is assigned to `Guard Door Lock`, the safety input is used to chain the guard door lock signal between devices such as several safety modules. The opening command of the guard door lock can only be sent if SI7 is at high level (24 V) else the closing command remains active. This behavior helps to consider the status of the upstream devices: the door cannot be opened until all the devices fulfilled the conditions. To chain the signal the safety output SQ3 of a safety module must be connected to the safety input SI7 of the following safety module. This chaining is done internally with a terminal adapter (*see page 39*).

Safety Function GDL Parameters

Parameter	Description	Possible values	Description
[SQ3 function assignment] 5 C 12	Configure the function on the output SQ3.	<ul style="list-style-type: none"> • Not Assigned • SBC Feedback • Guard Door Lock 	<ul style="list-style-type: none"> • Not Assigned • Chaining of the brake feedback • Guard door lock command
[SI7 function assignment] 5 C 13	Configure the function on the input SI7. NOTE: <ul style="list-style-type: none"> • This parameter can be set to <code>Guard Door Lock</code> if [SQ3 function assignment] 5 C 12 is set to <code>Guard Door Lock</code>. • If not assigned, the input must remain to 0V, else an error is triggered. 	<ul style="list-style-type: none"> • Not Assigned • SBC Feedback • Guard Door Lock 	<ul style="list-style-type: none"> • Not Assigned • Monitoring of the brake feedback • Guard door lock input signal
[GDL unlocking frequency] 5 C 14	Configure the frequency below which the delay to send the opening command of the guard door lock is [GDL short delay] 5 C 17	0...200.0 Hz Step: 0.1 Hz	Setting range. This parameter must be configured to a value greater than the minimum observable frequency.
[GDL long delay] 5 C 15(1)	Configure the opening command delay used if an uncontrolled stop is requested with a motor frequency greater than [GDL unlocking frequency] 5 C 14 .	0...3,600 s Step: 1 s	Setting range. The value must be equal to or greater than [GDL short delay] 5 C 17 .
[GDL short delay] 5 C 17(1)	Configure the opening command delay used if a controlled stop is requested or if an uncontrolled stop is requested with a motor frequency equal to or less than [GDL unlocking frequency] 5 C 14	0...3,600 s Step: 1 s	Setting range. The value must be different from 0 ms and, equal to or less than [GDL long delay] 5 C 15 .
(1) [GDL long delay] 5 C 15 and [GDL short delay] 5 C 17 are defined based on the characteristics of the machine.			

Chapter 4

Additional Features

What Is in This Chapter?

This chapter contains the following topics:

Topic	Page
Safety Module Start Signal	78
Output SQ1 function	80
Output Status SQ2 Function	82

Safety Module Start Signal

Overview

The safety module disables the power stage and locks enabling of the power stage after the following events:

- Switch-on of the drive,
- After the acknowledgment and the removal of the detected errors,
- After a STO activated via SLS (between the positive and negative standstill levels),
- After a SS1.

The safety module remains in the operating state Switch on disabled. In the operating state Switch on disabled, if the safety function requests are removed (inputs assigned to SS1 and SLS are at high level), the safety module unlocks enabling of the power stage depending on **[Start Mode type] 5 C 0 B** and **[Start Mode input assignment] 5 C 0 9**.

If the parameter **[Start Mode Type] 5 C 0 B** is to `Level/Auto`, the drive may transition automatically to the operating state `Operation Enabled`. Depending on the wiring and the configuration of the drive, this may result in immediate operation. If the parameter **[Start Mode Type] 5 C 0 B** is set to `Pulse`, a pulse is required to trigger this transition.

⚠ WARNING
UNANTICIPATED EQUIPMENT OPERATION
<ul style="list-style-type: none"> • Verify that the setting of this parameter does not result in unsafe conditions.
Failure to follow these instructions can result in death, serious injury, or equipment damage.

[Start Mode type] 5 C 0 B	[Start Mode input assignment] 5 C 0 9	Description
Pulse	SI5	Start on pulse. The start signal is triggered manually via a pulse on SI5. When the safety module switches in the operating state <code>Ready to Switch On</code> , the safety module waits for a pulse to switch in the operating state <code>Operation Enabled</code> : the safety module unlocks enabling of the power stage. If the duration is longer than 2 s, an error is triggered. This behavior helps to not consider a permanent connection of the start input to the 24 Vdc supply. NOTE: When the safety module switches in the operating state <code>Ready to Switch On</code> while 24 Vdc is already applied to SI5, the safety module triggers an error. This behavior helps to prevent a start due to a welding contact of the start button.
Level/Auto	SI5	Start on Auto/Level with input. When the safety module switches in the operating state <code>Ready to Switch On</code> and if 24 Vdc power supply is applied to SI5, then after 0.1 s, the safety module switches in the operating state <code>Operation Enabled</code> , the safety module unlocks enabling of the power stage. When the safety module switches to the operating state <code>Ready to Switch On</code> and if 24 Vdc is not applied to SI5, the safety module triggers an error.
Level/Auto	Not Assigned	Start on Auto/Level without input. Once the safety module is in the operating state <code>Ready to Switch On</code> , the safety module switches automatically in the operating state <code>Operation Enabled</code> after 0.1 s: the safety module unlocks enabling of the power stage.

After the safety module unlocks enabling of the power stage, the drive can enable the power stage.

NOTE: By default, **[Start Mode type] 5 C 0 B** is set to `Pulse` and **[Start Mode input assignment] 5 C 0 9** is set to `Not Assigned`, the start signal feature must be configured to meet your requirements.

NOTE: For more information on the operating states of the safety module, refer to [Operating States and State Transitions \(see page 115\)](#)

NOTE: The `Auto/Level` start with input is used if an external device is used to prevent the unwanted restart such as an emergency stop device.

Start on Pulse

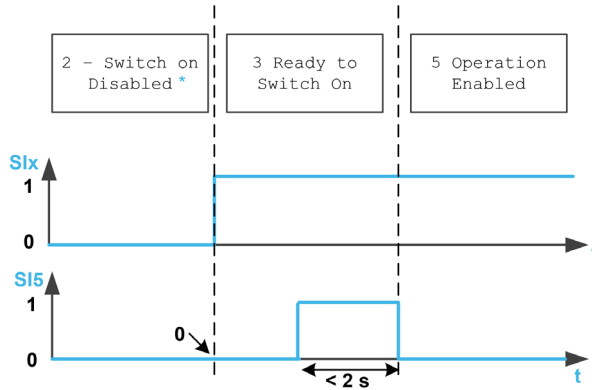

S1x Inputs assigned to the safety function SS1
 * In this operating state, the error has already been acknowledged and removed

Start on Auto/Level with input

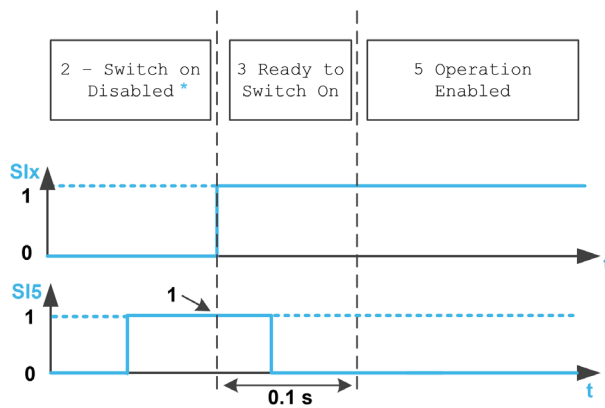

S1x Inputs assigned to the safety function SS1
 * In this operating state, the error has already been acknowledged and removed

Start on Auto/Level Without Input

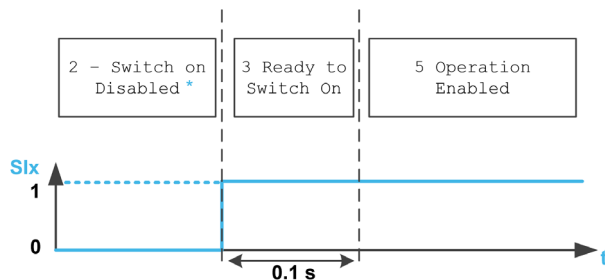

S1x Inputs assigned to the safety function SS1
 * In this operating state, the error has already been acknowledged and removed

Start Signal Parameters

Parameter	Description	Possible values	Description
[Start Mode type] 5 C 0 B	Select the type of start mode.	<ul style="list-style-type: none"> Pulse Auto/Level 	<ul style="list-style-type: none"> The start signal is triggered manually via the configured input. The start signal is triggered automatically. The used input can be deactivated.
[Start Mode Input Assignment] 5 C 0 9	Assign the start signal to a safety-related input	<ul style="list-style-type: none"> Not Assigned SI5 	<ul style="list-style-type: none"> Not input assigned to start signal. The start signal is assigned to SI5.

Output SQ1 function

Overview

The function assigned to the safety output SQ1 (dual channel) can be configured with the parameter **[SQ1A/B function assignment] 5 C 1 B**.

If this parameter is set to `SBC no torque after SS1`, the SBC function is assigned to the safety output SQ1. Refer to the description of the safety function SBC (see page 64).

If this parameter is set to a value different from `SBC no torque after SS1`, the safety output SQ1 is used to enable other consumers depending on your needs.

For example, power contactors with forcibly guided contacts can be connected to the output SQ1. The normally opened contacts of the power contactors must be connected in series to enable the consumer. If the power contactors are used to switch mains voltage, the power contactors must meet the requirement of protective separation. In order to help prevent the start of the safety module in case of welding contacts, the normally closed contacts of the power contactors must be connected in series on the input SI5. It depends on the configuration of the start signal. Refer to "Safety Module Start Signal" for more information (see page 78).

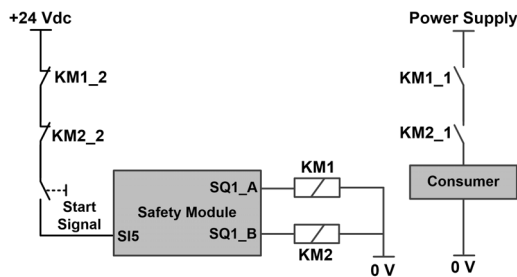

The wiring of KM1_2 and KM2_2 contacts on the start signal helps to prevent the start of the safety module in case of welding contacts on the power contactors KM1 and KM2 if KM1_2 and KM1_1 are mechanically linked but also KM2_2 and KM2_1.

Behavior of Output SQ1 function

Irrespective of **[SQ1A/B function assignment] 5 C 1 B** configuration, the output SQ1 is activated when the safety module switches in the operating state `Operating Enabled`. Depending on **[SQ1A/B function assignment] 5 C 1 B** configuration, SQ1 is deactivated on one of the following events:

- ① Activation of SS1 (such as request via inputs assigned to SS1),
 - ② After the delay **[SQ1A/B delay after SS1 activation] 5 C 1 9** on activation of SS1,
 - ③ SS1 standstill level reached (parameter **5 C 3 3**) on activation of SS1,
 - Safety function SBC: at SS1 standstill level, brake engage command after **[SBC engage delay] 5 C 5 3**.
- Refer to the description of the safety function SBC (see page 64).

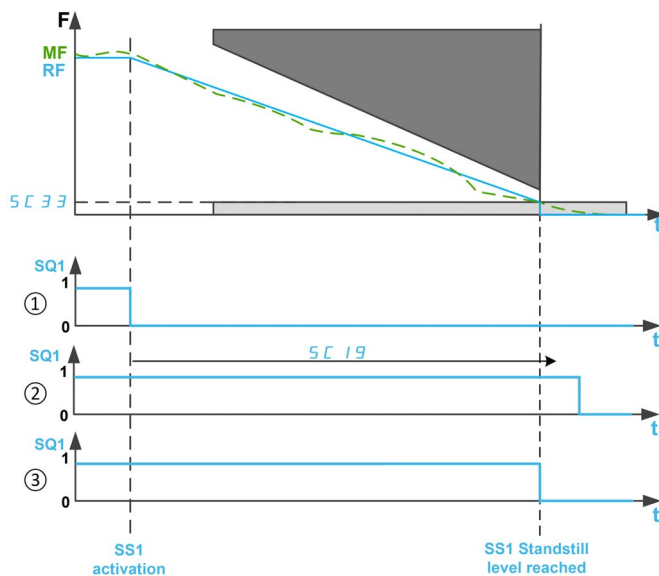

F: Frequency / **RF**: Reference Frequency / **MF**: Motor Frequency

t: time

5 C 3 3: SS1 Standstill level

5 C 1 9: SQ1A/B delay after SS1 activation

Note:

- During SS1, the drive state shows SS1 until both of the following events are verified: SQ1 is deactivated and SS1 standstill level is reached (parameter **5 C 3 3**). Then STO is displayed. An error class 2 corresponds to a type of SS1 activation. Instead of showing STO, the drive state shows the detected error.
- Irrespective of **[SQ1A/B function assignment] 5 C 1 B** configuration, if an error class 3 or 4 occurs or if STO is triggered (for example, on reaching of SLS standstill level), the safety output SQ1 is deactivated immediately except if SS1 has been previously activated.
- If SS1 is not assigned to an input (parameter **[SS1 input assignment] 5 C 2 7** is set to Not Assigned), **[SQ1A/B function assignment] 5 C 1 B** can only be set to No delay after SS1 activation.
- With Auto/level start signal, after SS1 (*see page 49*) the power stage is locked. If the source of SS1 activation has been deactivated before its completion, SQ1 signal remains at 0 Vdc during 100 ms (SQ1 signal switches back to 24 Vdc automatically), then the power can be enabled again by the drive.

Output SQ1 Function Parameters

Parameter	Description	Possible Values	Description
[SQ1A/B function assignment] 5 C 1 B	Configure the function available on the safety output SQ1. The safe output is deactivated (low level) on the occurrence of the configured event.	<ul style="list-style-type: none"> • No delay after SS1 activation • Delay after SS1 activation • SS1 standstill • SBC no torque after SS1 	<ul style="list-style-type: none"> • At SS1 activation. • At SS1 activation, after the delay [SQ1A/B delay after SS1 activation] 5 C 1 9. • At SS1 standstill level reached. • Safety function SBC: at SS1 standstill level, brake engage command after [SBC engage delay] 5 C 5 3.
[SQ1A/B delay after SS1 activation] 5 C 1 9	This parameter configures the delay after which the output SQ1 is deactivated on SS1 activation or on error class 2. This parameter can be configured if [SQ1A/B function assignment] 5 C 1 B is set to Delay after SS1 activation.	0...10,000 ms Step: 1 ms	Setting range.

Output Status SQ2 Function

State Request Via State Output

The state outputs SQ2_A and SQ2_B provide the state of the safety module such as inputs, outputs, error, activation of a safety function, and so on.

The state outputs SQ2_A and SQ2_B are configured separately via the parameters **[SQ2A function assignment] 5 C 2 0** and **[SQ2B function assignment] 5 C 2 1**.

SQ2_A and SQ2_B are not approved for any type of safety-related use.

State Output Parameters

Parameter	Description	Possible Values	Description
[SQ2A Function assignment] 5 C 2 0	Configure the state provided via the state output SQ2_A.	<ul style="list-style-type: none"> ● Not Used ● State of SI1 (active 24V) ● State of SI2 (active 24V) ● State of SI3 (active 24V) ● State of SI4 (active 24V) ● State of SI5 (active 24V) ● State of SI6 (active 24V) ● State of SI1 (active 0V) ● State of SI2 (active 0V) ● State of SI3 (active 0V) ● State of SI4 (active 0V) ● State of SI5 (active 0V) ● State of SI6 (active 0V) ● State of SQ1 (active 24V) ● State of SQ1 (active 0V) ● Warning (active 24V) ● Error class 2 (active 24V) ● Error class 3 (active 24V) ● Error class 4 (active 24V) ● Warning (active 0V) ● Error class 2 (active 0V) ● Error class 3 (active 0V) ● Error class 4 (active 0V) ● State of internal STO (active 24V) ● State of internal STO (active 0V) ● State of CCM24V ● Frequency below SLSthreshold (active 24V)⁽¹⁾ ● Frequency below SLS threshold (active 0V)⁽¹⁾ 	<p>Active 24V: The output is at high level (24V) if the corresponding state is at high level (1).</p> <p>Active 0V: The output is at low level (0V) if the corresponding state is at high level (1).</p>
[SQ2B Function assignment] 5 C 2 1	Configure the state provided via the state output SQ2_B.	[SQ2A function assignment] 5 C 2 0	-

(1): This parameter can only be set to Frequency below SLS threshold if the safety function SLS has been assigned. In this case, the state of the output switches according to the motor frequency and irrespectively of the activation of the safety function SLS. In case of open loop motor control, if the power stage is disabled (such as during a freewheel stop), the motor frequency monitored by the safety module is equal to 0 Hz consequently the state of the output is not relevant.

Chapter 5

Behavior of Safety Functions

What Is in This Chapter?

This chapter contains the following topics:

Topic	Page
Limitations	84
Priority Between Safety Functions	86
Compatibility and Precedence of Safety Functions and Non-Safety-Related Functions	87

Limitations

Type of Motor

Table with four columns

Type of Motor	Open/Closed Loop motor control ⁽¹⁾	Safety Functions				
		SS1	SLS	SMS	SBS	GDL
Asynchronous	Open loop	✓	✓	✓	✓	✓
	Closed loop	✓	✓	✓	✓	✓
Synchronous ⁽²⁾	Open loop	-	-	-	-	-
	Closed loop	✓	✓	✓	✓	✓

(1): For the possible [Motor Control Type] *LEL* settings, refer to the Priority Table (*see page 87*)
 (2): Permanent magnets synchronous motors. Reluctance motors are not covered by the safety module.

Prerequisites for Using Safety Functions

⚠ WARNING

LOSS OF SAFETY FUNCTION

Incorrect usage may cause a hazard due to the loss of the safety function.

- Observe the requirements for using the safety function.

Failure to follow these instructions can result in death, serious injury, or equipment damage.

Following conditions have to be fulfilled for correct operation with the safety module:

- The maximum output frequency is equal to or less than 200 Hz,
- The motor size is adequate for the application and is not at the limit of its capacity.
- The application inertia is adequate for the safety module.
 Example: A controlled stop (with SS1) or a deceleration ramp with SLS cannot be done in a time longer than 8 min 20 s if the deceleration starts from 50 Hz and ends to 0 Hz. The minimum of the deceleration ramp and the deceleration monitoring is 0.1 Hz/s.
- The drive has been correctly chosen for the line supply, sequence, motor, and application and is not at the limit of their capacities as stated in the catalog
- If required, the appropriate options are used.
 Example: dynamic braking resistor or motor choke. Encoder Module for closed loop control.
- The drive is correctly set up with the correct speed loop and torque characteristics for the application; the reference frequency profile applied to the drive control loop is followed.
- During a category 0 stop (as per IEC 60204), the motor coasts down in an uncontrolled way. If access to the machine coasting down involves a hazard (results of the hazard and risk analysis), you must take appropriate measures.
- A controlled stop must be triggered with a category 1 stop (as per IEC 60204). The controlled stop is not monitored by the drive system. In the case of power outage or an error, a controlled stop is impossible.
- Tests of IGBTs at power on of the drive cannot be fulfilled with safety module inserted in the drive. This is also the case for tests of IGBTs done via [IGBT Diag w/o motor] *W o E* and [IGBT Diag w motor] *W E*.

Allowed and Unallowed Application for Safety Function

Applications with acceleration of the load after disabling the output power bridge are not allowed (for example, applications with long/permanent regenerative braking cycles).

Examples: Vertical Conveyors, Vertical hoist, Lifts, or Winders.

Disable Error Detection

The errors linked to the safety module (*S o F*, *S H V F*, *S C F F* and *i n F i*) cannot be inhibited by the function [Error Detection Disable] *i n H -*.

Electrical Frequency and Mechanical Frequency

Two motor frequencies can be defined:

- The electrical frequency corresponding to the stator frequency of the motor,
- The mechanical frequency corresponding to the rotor frequency of the motor.

The motor frequency is monitored in each of the 2 channels of the safety module. To help prevent frequency deviation (or inconsistency), the safety module cross compares these 2 motor frequencies:

- In open loop control, two electrical frequencies are compared.
- In closed loop control, an electrical frequency is compared with the mechanical frequency.

The threshold of frequency deviation is defined via the parameter **[Allowed frequency deviation] 5 C D 4**.

The threshold must consider several factors such as application inertia, stress of the motor (acceleration/deceleration), slip of the motor in order to have a correct compromise between robustness and reliability.

In case of frequency deviation, **[Motor Freq Deviation] 5 P E D 2 C** error code is triggered.

Minimum Observable Frequency

The safety module can be used with or without encoder (closed loop control or open loop control).

In both open and closed loop control, the electrical motor frequency (corresponding to the stator frequency) is monitored by the safety module.

The electrical motor frequency is not observable below a frequency level depending on several factors such as the type of motor control and motor power supply.

Consequently, parameters such as standstill levels, setpoints and thresholds must be greater than this minimum observable frequency. Refer to the parameter table of each safety function to acknowledge the list of parameters impacted by this minimum observable frequency.

The parameter **[Min Observable Freq] 5 F P n** can help to determine the observable frequency and to configure the safety module.

During operation, if the current motor frequency is non-observable and it is greater than a safety-related parameter (threshold, standstill level or setpoint), an error is triggered and the error code **[Low Freq Settings] 5 P E D 4 9** or **[Low Freq Settings] 5 P E D 4 b** is raised. In this case, verify the setting of the parameters.

For more information on the minimum observable frequency, contact your local Schneider Electric Service.

To help prevent an error due to this behavior, verify the correct sizing of your drive with your motor and application.

Example:

If the minimum observable frequency is 4 Hz, **[SS1 Standstill Level] 5 C 3 3** cannot be set to 3 Hz. Below 4 Hz, it is not possible to know if the standstill level has been reached or not. However, if **[SS1 Standstill Level] 5 C 3 3** is set to 5 Hz then, at SS1 activation, when the motor frequency reaches 5 Hz, the motor frequency remains observable then STO is triggered.

The motor can still run at low frequency without triggering an error. If the motor is running below 4 Hz, the motor frequency is not observable. At SS1 activation, with **[SS1 Standstill Level] 5 C 3 3** set to 5 Hz, the observable zone is included in the standstill zone consequently it is possible to know that the standstill level is already reached.

Disabling the Power Stage

If the power stage is disabled (such as during a freewheel stop), the motor frequency (electrical frequency) monitored by the safety module is equal to 0 Hz.

In case of open loop motor control:

- if the power stage is disabled during an active safety function which has a configured standstill level (such as SS1 or SLS type 2), STO is immediately applied.
- if the power stage is disabled before the activation of SMS or SLS (type 4, 5 or 6), an uncontrolled stop from the maximum frequency must be considered.

In case of closed loop motor control, an error is triggered (error code **[Unexpected STO] 5 P E D d 4** or **[Sfty Fct in Freewheel] 5 P E D 7 1**):

- if the power stage is disabled during SS1 deceleration,
- if a safety function is requested after the disabling of the power stage.

For any STO activation or a detected error, if the SBC function is configured, the closing command of the brake is immediately applied.

Priority Between Safety Functions

Order of priority between the safety functions

1. The safety function STO has the highest priority. If the safety function STO is triggered, a Safe Torque Off is performed regardless of which other functions are active.
2. The safety function SS1 has medium priority in relation to the other safety functions.
3. The safety functions SLS has the lowest priority.

The safety function SBC is linked to the safety functions SS1 and STO.

The safety function SMS is linked to the motor frequency. The function is independent from the other safety functions. SMS can be enabled and active during SS1 or SLS.

The safety function GDL is independent from other safety functions.

Compatibility and Precedence of Safety Functions and Non-Safety-Related Functions

Compatibility Table

⚠ WARNING
UNANTICIPATED EQUIPMENT OPERATION
Verify that you do not use those application functions and safety functions concurrently that are designated as incompatible in the following table.
Failure to follow these instructions can result in death, serious injury, or equipment damage.

O: Compatible functions

X Incompatible functions

▲◄: The function to which the arrow points takes precedence over the other function.

•: The behavior depends on the type of control and the function activation order. Refer to Disabling the Power Stage for more information ([see page 85](#))

Drive Function	SS1	SLS	SMS	SBC	GDL
[High Speed Hoisting] <i>H S H -</i>	X	X	X	X	x
[+/- speed] <i>u P d -</i>	▲	▲	O	O	O
[Jump Frequency] <i>J u F -</i>	▲	▲: during deceleration ramp ◄: out of the deceleration ramp	O	O	O
[Stop after speed timeout] <i>P r S P -</i>	X	X	X	X	X
[Multimotors config] <i>Π Π C -</i> Configuration must be consistent with the 3 motors (such as motor and encoder parameters, frequency threshold)	O	O	O	O	O
[Preset speeds] <i>P S S -</i>	▲	▲	O	O	O
[PID controller] <i>P i d -</i>	▲	X	O	O	O
[Ramp] <i>r R P P -</i>	▲	▲	O	O	O
[Ramp switching] <i>r P L -</i>	▲	▲	O	O	O
[Freewheel stop Assign] <i>n S L</i>	•	•	•	O	O
[Fast stop Assign] <i>F S L</i>	▲	▲	O	O	O
[External Error] <i>E L F -</i>	•: YES (freewheel) X: DCI ▲: LFF, RLS, RMP, FST	•: YES (freewheel) X: DCI ▲: LFF, RLS, RMP, FST	•	O	O
[Auto Fault Reset] <i>R L r -</i> If STO is active by the safety module, the function is disabled.	▲	O	O	▲	O
[Fault Reset] <i>r S L -</i>	O	O	O	O	O
[Jog] <i>J o G -</i>	▲	▲	O	O	O
[Type of Stop] <i>S L L</i>	•: NST X: DCI ▲: RMP, FST	•: NST X: DCI ▲: RMP, FST	•	O	O
[+/- speed around ref] <i>S r E -</i>	▲	▲	O	O	O
[Positioning by sensors] <i>L P o -</i>	X	X	X	X	O

Drive Function	SS1	SLS	SMS	SBC	GDL
[Product Restart Assign] r P R If the safety module is not supplied, STO is activated by the safety module and the outputs are deactivated. Consider the settings of the start signal when restoring the supply.	O	O	O	O	O
[Process underload] u L d -	O	O	O	O	O
[Process overload] o L d -	O	O	O	O	O
[Rope Slack Handling] S d r -	X	X	X	X	X
[Dynamic load detect.] d L d -	X	X	X	X	X
[undervoltage handling] u 5 b -	•	•	•	O	O
[Load Sharing] L d 5 -	◀	◀	O	O	O
[Motor Control Type] C E E If this parameter is set to a value not compatible with the use of the safety module, an error is triggered.					
• [SVC V] v v C	O	O	O	O	O
• [FVC] F v C	O	O	O	O	O
• [Sync. Mot.] S Y n	X	X	X	X	X
• [Energy Sav.] n L d	O	O	O	O	O
• [Sync. CL] F S Y	O	O	O	O	O
• [U/F VC 5pts] u F 5	O	O	O	O	O
• [SYN_U VC] S Y n u	X	X	X	X	X
• [Rel. Mot.] S r v C	X	X	X	X	X
[Output Ph Rotation] P H r (Verify the value is identical to [Motor rotation inversion] S C D 3)	O	O	O	O	O
[Output phase loss] o P L -	O	O	O	O	O
[OutPhaseLoss Assign] o P L = [No Error Triggered] o R C	X	X	X	X	O
[2/3-Wire Control] E C C					
• [2-Wire Control] 2 C	O	O	O	O	O
• [3-Wire Control] 3 C	O	O	O	O	O
[Forced Local] F L o	▲	▲	O	O	O
[Command Switching] C C 5	▲	▲	O	O	O
[Freq Switch Assign] r F C	▲	▲	O	O	O
[Drive Lock] L E 5	•	•	•	O	O
[Error detection disable] i n H -	O	O	O	O	O
[Parameters switching] n L P -	O	O	O	O	O
[Ref. operations] o R i -	▲	▲	O	O	O
[Motor short circuit] S C F I	O	O	O	O	O
[Ground short circuit] S C F 3	O	O	O	O	O
[Motor Overspeed] S o F	O	O	O	O	O
Configuration Transfer Safety and drive configuration are transferred. The activation code is requested.	O	O	O	O	O
[Limit switches] L 5 E -	•: NST ▲: RMP, FST	•: NST ▲: RMP, FST	•: NST O: RMP, FST	O	O
[Catch on the fly] F L r -	▲: Measured X: Computed	O: Measured X: Computed	O: Measured X: Computed	▲: Measured X: Computed	O: Measured X: Computed
[High Speed Switching] C H 5 -	O	O	O	O	O
[Encoder check] E n C	O	O	O	O	O

Drive Function	SS1	SLS	SMS	SBC	GDL
[Reverse disable] <i>r E i n -</i>	O	O	O	O	O
[Backlash compensation] <i>b 5 9 n -</i>	▲	▲	O	O	O
[Fluxing by DI] <i>F L i -</i> If SS1 or SBC is activated, the motor fluxing is not done.	▲	O	O	▲	O
[Memo reference frequency] <i>5 P n -</i>	O	▲	O	O	O
[Stall Monitoring] <i>5 t P r -</i>	•	•	•	O	O
[Encoder monitoring] <i>5 d d -</i>	X	X	X	X	X
[Brake Logic Control] <i>b L C -</i>	O	O	O	O	O
[Torque Control] <i>t o r -</i>	X	X	O	O: if [SMS violation response] <i>5 C B 1</i> is set to STO with error	O
[Auto DC Injection] <i>A d C -</i>	▲	O	O	▲	O
[DC Injection Assign] <i>d C i</i>	X	X	X	X	X
[Motor tune] <i>n t u -</i> If SS1 or SBC is activated, the motor tuning is not performed.	▲	O	O	▲	O
[External weight meas.] <i>E L n -</i>	O	O	O	O	O
[Dec. Ramp Adapt] <i>b r R</i>	▲	▲	O	O	O
[Output contactor cmd] <i>o C C -</i>	◀	◀	O	O	O
[Frequency Meter] <i>F 9 F -</i>	•	•	•	O	O
[Boost] <i>b o o</i> If the safety module is used with permanent magnet synchronous motors, [Boost Activation] <i>b o R</i> is forced to [Constant] <i>C 5 t E</i> . Additionally, [Boost] <i>b o o</i> setting value switches to -30 % and its setting range is -100% to -30 %.	O	O	O	O	O
[Angle test setting] <i>R 5 R -</i>	O: PSI, PSIO, RCI X: IPMA, SPMA	O: PSI, PSIO, RCI X: IPMA, SPMA	O: PSI, PSIO, RCI X: IPMA, SPMA	O: PSI, PSIO, RCI X: IPMA, SPMA	O: PSI, PSIO, RCI X: IPMA, SPMA
[Stop on top Z] <i>t o 5 t</i>	▲	▲	O	O	O
[Spd Loop Optimization] <i>n C L -</i>	O	O	O	O	O
Mechanical resonance rejection	O	O	O	O	O
[Master/Slave] <i>n 5 n -</i>	X	X	X	X	X
IPAR	X	X	X	X	X
FDR	X	X	X	X	X
[FAN Diagnostics] <i>F n t</i>	O	O	O	O	O
[HMI LED Diagnostics] <i>H L t</i>	O	O	O	O	O
[IGBT Diag w motor] <i>i W t</i>	X	X	X	X	X
[IGBT Diag w/o motor] <i>i W o t</i>	X	X	X	X	X

Chapter 6

Commissioning and Display

What Is in This Chapter?

This chapter contains the following topics:

Topic	Page
Prerequisites to Configure The Safety Module	92
Configuration with The Commissioning Software	93
Acceptance Test and Machine Signature	99
Additional Features for The Commissioning	100
Copying Safety-related Configuration	103
Display	106
Dedicated Safety Function menu in the Display Terminal	107

Prerequisites to Configure The Safety Module

Prerequisites

The configuration of the safety module can only be done via the commissioning software SoMove FDT and Altivar DTM. To start the configuration:

- Download the latest version of the commissioning software and the latest Altivar DTM (see the related documents). Once installed open the commissioning software.
- Verify that the firmware of the drive, the firmware of the safety module and the DTM version are compatible.
- Install the safety module.
- Connect to the drive using the commissioning software.
- Before starting to configure the parameters of the safety module, configure the standard parameters of the drive. A safety-related configuration is associated to a specific standard configuration of the drive. A modification of the configuration of the drive must be done accordingly with the safety-related configuration.

If the safety module is inserted, the drive remains locked in STO until a safety configuration is activated. In order to perform some actions (such as, entering the motor nameplate and the motor parameters or performing an autotuning), the configuration of the drive can be started before the installation of the safety module. However, if the setting value of some parameters (such as **[Boost Activation] b o R**) is not consistent with the use of the safety module, the setting value is modified (*see page 123*).

It is possible to prepare a configuration offline in order to transfer it later. In "Configuration with the Commissioning Software" (*see page 93*), online configuration is described.

SoMove Software

The use of SoMove FDT and Altivar DTM is required to perform the actions described in this chapter.



Use the links below to download these files:

File	Links
SoMove FDT	SoMove_FDI (English, French, German, Spanish, Italian, Chinese)
Altivar 340: DTM	ATV340 DTM Library EN (English), ATV340 DTM Lang FR (French), ATV340 DTM Lang DE (German), ATV340 DTM Lang SP (Spanish), ATV340 DTM Lang IT (Italian), ATV340 DTM Lang CN (Chinese)

Dedicated Tabs for Safety Module

Two tabs are dedicated to the safety module:

- The **Safety Conf** tab: This tab is used to configure the safety module (its safety functions and its inputs/outputs), to generate the safety report, to transfer/import a safety configuration, and to manage the password of the safety configuration. Additionally, it provides an overview of the safety functions via figures. In read-only mode, it shows the configuration of the safety module.
- The **Safety Display** tab: It shows the status of the safety module and the state of the inputs/outputs of the safety module (*see page 106*).

The safety module must be selected in the drive topology in order to access these tabs.

Configuration with The Commissioning Software

Steps to Start The Safety Configuration

After the configuration of the parameters of the drive, start the configuration of the safety module:



Step	Description
1	Click Safety Conf tab.
2	If there is already a safety configuration on the connected drive, you directly access to the safety configuration of the drive in read-only mode. Go to the step 6. If this is not the case, go to the next step.
3	If there is no safety configuration on the connected drive, you have two buttons <ul style="list-style-type: none"> ● Click the Create button to create a new safety configuration. ● Click the Open button to open an existing Safety Conf File (file name extension: .sft). Refer to "Export the Safety Conf File to PC".
4	If you have clicked on Create button, a Create Password dialog box is displayed: <ul style="list-style-type: none"> ● Type the new configuration password in New Password box. ● Retype this configuration password in Re-Type New Password box. ● Click OK. <p>Take carefully note of it inside the machine maintenance guide.</p> <p>NOTE: The password must contain: <ul style="list-style-type: none"> ● 6 Characters, ● At least 1 number ● At least 1 alphabetical character, ● At least 1 special character (such as !, ?, /, -) </p> <p>Example of password: ATV01#</p>
4	If you have clicked on Open button, a dialog box is displayed in order to open an Existing Conf File .sft. Once the file selected and opened, go to the next step.
5	Click on Edit Configuration button to access in write mode. An Enter Password dialog box is displayed. Type the password of the safety configuration in Enter Password box then click on OK.
6	Once the password defined or entered, you can create or modify the safety configuration for the safety module.

Creation of the safety configuration

Once connected and the password defined/entered, you can create the safety configuration via the Safety Conf tab. The configuration includes:

- The **Motor/Encoder** of the drive,
- The **Inputs/Outputs** of the safety module,
- The safety functions **SS1, SLS, SBC, SMS** and **GDL**.

The commissioning software provides some helps during the configuration of the safety module. It indicates via pictograms the following information:

Pictogram	Description
	Tooltip pictogram. Point this pictogram with your cursor to obtain additional information on the related parameter.
	Invalid configuration pictogram. If linked to a parameter, point this pictogram with your cursor to obtain information on the probable cause of the invalid configuration. If no information is given via the pictogram, it means the parameter must be configured. If linked to a tab such as Motor/Encoder, Inputs/Outputs, SS1, SMS , it indicates that the related tab contains an invalid configuration. NOTE: The current selected tab never shows this pictogram.

Step	Description
1	<p>In the Motor / Encoder tab,</p> <ul style="list-style-type: none"> ● Click Apply Motor & Encoder Config button to import both the motor and encoder settings from the drive configuration, or ● Configure manually the motor parameters then, in case of closed loop control, configure the encoder parameters. <p>Depending on the encoder, <u>all the encoder parameters cannot be imported from the drive configuration</u>. For additional information on this step, refer to Motor/Encoder configuration below (<i>see page 96</i>).</p>
2	<p>Once the Motor / Encoder tab configured, click on Inputs / Outputs tab.</p>
3	<p>In the Inputs / Outputs tab,</p> <ul style="list-style-type: none"> ● Modify, if necessary, the settings of the Manual/Automatic Start. For additional information, refer to the Additional Features part (<i>see page 78</i>). ● Assign the safety functions to the safety inputs of the safety module. Two safety functions cannot be assigned to the same inputs. ● If SS1 is assigned to a safety input, configure, if necessary, the function on the safety output SQ1. Depending on your needs refer to SBC description (<i>see page 64</i>) or to Additional Features part (<i>see page 80</i>) for additional information. ● Depending on your needs, configure the functions on the outputs SQ2_A and SQ2_B. For additional information, refer to the Additional Features part (<i>see page 82</i>). ● Depending on your needs, configure the Interlock settings to enable the SBC feedback monitoring (<i>see page 64</i>) or to enable the safety function GDL (<i>see page 74</i>). <p>Once this tab configured (no mismatch pictogram is displayed), access to SS1 tab.</p>
4	<p>In the SS1 tab, configure the parameters linked to SS1. For additional information, refer to the description of the safety function SS1 (<i>see page 49</i>). Once this tab configured (no invalid configuration pictogram is displayed), access to the unlocked tabs (such as SLS, SMS, etc.).</p>
5	<p>If a safety input has been assigned to SLS in the Inputs/Outputs tab, access to SLS tab to configure the function else go to the next step. For additional information, refer to the description of the safety function SLS (<i>see page 53</i>).</p>
6	<p>If the assignment of SQ1 function has enabled SBC in the Inputs/Outputs tab, access to SBC tab to configure the function else go to the next step. For additional information, refer to the description of the safety function SBC (<i>see page 64</i>).</p>
7	<p>If SMS has been enabled in the Inputs/Outputs tab, access to SMS tab to configure the function else go to the next step. For additional information, refer to the description of the safety function SMS (<i>see page 69</i>).</p>
8	<p>If the Interlock settings has enabled the GDL function in the Inputs/Outputs tab, access to GDL tab to configure the function else go to the next step. For additional information, refer to the description of the safety function GDL (<i>see page 74</i>).</p>
9	<p>Once each tab of the Safety Conf tab is properly configured (no invalid configuration pictogram is displayed), the safety configuration is ready to be transferred. The Transfer Button is enabled. If the Transfer button is disabled, verify the consistency of the safety configuration, the consistency of the safety configuration with the drive configuration (motor and encoder parameters). Finally, verify that the commissioning software is connected to the drive (online).</p>
10	<p>Go to the part "Transfer and activate the safety configuration".</p>

Transfer and Activate The Safety Configuration

After the activation code is entered at the Display Terminal, the drive may transition automatically to the operating state `Operation Enabled`. Depending on the wiring and the configuration of the drive, this may result in immediate operation.

WARNING

UNANTICIPATED EQUIPMENT OPERATION

- Verify that there are no persons or obstructions in the zone of operation before entering the activation code at the Display Terminal.
- Verify that you are fully aware of all consequences of entering the operating state `Operation Enabled`.

Failure to follow these instructions can result in death, serious injury, or equipment damage.

Once the safety configuration is ready to be transferred, follow the next steps:

Step	Description
1	In the Safety Conf table, click on Transfer button to transfer to the connected drive the safety module configuration (in accordance with the specific drive configuration). The transfer cannot be performed if the drive is in operation enabled or if the function <code>Forced Local</code> is active.
2	If a safety configuration with a different password is already stored in the connected drive, a dialog box is displayed else go to the next step. In this dialog box, you must enter the password configuration of the safety configuration you are about to erase. Once properly entered, go to the next step.
3	A Transfer Configuration dialog box is displayed. It shows the current status of the drive and the Activation Code into enter in the drive via the Display Terminal. NOTE: <ul style="list-style-type: none"> • The activation of a safety configuration must be executed via a local connection. • The Activation Code is composed by 4 characters (letters and digits). • The drive remains locked in <code>STO</code> until the safety configuration is activated. • At this step, the status of the safety module [Safety Config Status] 5 C n A is [Validated] V A L.
4	Follow the process to enter the [Activation Code] 5 C A C via the Display Terminal. Note the code carefully inside the machine maintenance guide. NOTE: <ul style="list-style-type: none"> • Several dialog boxes are displayed on the Display Terminal during this procedure. • Instead of pressing OK to enter the code, press ESC if you want to abort the activation process. • If the dialog box has been closed in the DTM, the Activation Code is displayed in the bottom left corner of the DTM in the Safety Conf tab. • If the activation code cannot be entered on the Display Terminal (for example, after a power outage), the safety configuration will have to be transferred again.
5	If the activation code has been aborted, the activation code can always be entered via the Display Terminal. Access to the parameter [Activation Code] 5 C A C in the menu [Complete Settings] C 5 E - → [Safety Module] a 5 n - .
6	Once the Activation Code is correctly entered, the safety configuration is activated and the status of the safety module [Safety Config Status] 5 C n A switches in [Activated] A P r V .
7	Perform the acceptance tests of your machine. For more information, refer to the Acceptance Test and Machine Signature (<i>see page 99</i>).
8	Once the acceptance tests performed, the safety report of the safety configuration can be generated with the DTM by clicking on Generate Safety Report button. A dialog box is opened allowing you to choose the name of the pdf file and the location to store this file. NOTE: The safety report contains the activation code and information of the safety configuration. For more information refer to "Generate Safety Report" (<i>see page 101</i>).

Motor / Encoder Configuration

The parameters show in the **Motor / Encoder** tab can be automatically filled according to the drive configuration by clicking on **Apply Motor & Encoder Config** button. Verify that the imported values correspond to your application.

It is possible to fill them in manually. In this case, ensure that the settings are consistent with the drive configuration.

After a safety configuration transfer, if the motor and encoder parameters inside the drive configuration are modified (via the Display Terminal and/or via the commissioning software), the safety configuration must be performed again to remain consistent. Otherwise, the monitoring functions of the safety module will trigger an error.

The following table shows the motor parameters used for the safety configuration:

Parameter	Description	Possible Values	Description
[Motor type] <i>SCD1</i>	Type of motor. The value must be consistent with the setting of [Motor Control Type] <i>CLE</i> . NOTE: Permanent Magnet Synchronous Motor can only be used with closed loop control.	<ul style="list-style-type: none"> • Undefined • Asynchronous Motor • Permanent Magnet Synchronous Motor 	To set this parameter refer to the table below.
[Motor pole pair number] <i>SCD2</i>	Number of pole pairs of the motor.	<ul style="list-style-type: none"> • Undefined • 1...65,535 pole pairs 	Setting range. To set this parameter refer to the table below.
[Motor rotation inversion] <i>SCD3</i>	Output phase rotation. The value must be consistent with the setting of [Output Ph Rotation] <i>PHr</i> .	<ul style="list-style-type: none"> • Inactive • Active 	To set this parameter refer to the table below.
[Allowed frequency deviation] <i>SCD4</i>	Allowed motor frequency deviation. Defines the maximum tolerated frequency difference between internal estimated/measured motor frequency (<i>see page 85</i>). The setting of this parameter depends on the application (frequency overshoot, inertia, acceleration, motor slip, etc.). It is a compromised between robustness and reliability.	0...200.0 Hz Step: 0.1 Hz	Setting range. Factory setting: 2 Hz

The following table shows the settings of the motor parameters according to the type of motor and the type of loop control:

Parameter	Asynchronous motor		Permanent Magnet Synchronous motor
	Open loop ⁽¹⁾	Closed loop ⁽²⁾	Closed loop ⁽³⁾
[Motor Type] <i>SCD1</i>	Asynchronous motor		Permanent Magnet Synchronous motor
[Motor pole pair number] <i>SCD2</i>	This parameter must be set to the closest integer equal to or less than: 60*FRS/NSP With <i>FRS</i> : [Nominal Motor Freq] and <i>NSP</i> : [Nominal Motor Speed] Example: FRS = 50 Hz and NSP = 1460 rpm then SCD2 = 2		This parameter must be set to the same value as [Pole pairs] <i>PPn5</i> .
[Motor rotation inversion] <i>SCD3</i>	<ul style="list-style-type: none"> • Inactive: If [Output Ph Rotation] <i>PHr</i> is set to [ABC] <i>AbC</i>. • Active: If [Output Ph Rotation] <i>PHr</i> is set to [ACB] <i>ACb</i> 		
[Allowed frequency deviation] <i>SCD4</i>	If required, modify the value depending on the application: it may be reduced close to 0 Hz.	If required, modify the value depending on the application: it must greater than the slip of the motor.	If required, modify the value depending on the application: it may be reduced close to 0 Hz.
(1): If [Motor Control Type] <i>CLk</i> is set to [SVC V] <i>VVL</i> , [U/F VC 5pts] <i>UF5</i> , [Energy sav.] <i>nLd</i> .			
(2): If [Motor Control Type] <i>CLk</i> is set to [FVC] <i>FVL</i> .			
(3): If [Motor Control Type] <i>CLk</i> is set to [Sync.CL.] <i>F5Y</i> .			

The following table shows the encoder parameters used for the safety configuration:

Parameter	Description	Possible Values	Description
[Encoder type] <i>SCD5</i>	Type of encoder. The setting of this parameter	<ul style="list-style-type: none"> • Undefined • No encoder used • AB or HTL option module • EnDat2.2 option module • SSI option module • SinCos option module • Resolver option module • AB Embedded • SinCos embedded 	<ul style="list-style-type: none"> • Undefined: invalid configuration. • To set this parameter refer to the tables below.
[Encoder resolution] <i>SCD6</i>	Resolution of encoder.	<ul style="list-style-type: none"> • undefined • 1...65,535 	Setting range (the unit depends on the type of encoder). To set this parameter refer to the tables below.
[Encoder rotation inversion] <i>SCD7</i>	Inversion of encoder rotation direction. The setting of this parameter must be consistent with the setting of [Encoder Rotation Inv.] <i>Enr</i> , or the setting of [Emb Enc Rotation Inv] <i>Eer</i> , depending on the encoder used.	<ul style="list-style-type: none"> • Inactive • Active 	To set this parameter refer to the tables below.

The following tables show the settings of the encoder parameters according to the type of encoder and the type of control loop if an encoder option module is used:

NOTE: In case of open loop, [Encoder type] *SCD5* must be set to No encoder used and the parameters [Encoder resolution] *SCD6* and [Encoder rotation inversion] *SCD7* are not set. In this case, the drive parameters [Encoder usage] *Enu* and [Emb Enc usage] *Enu* must be configured to a setting different from [Speed Regulation] *rEG*.

	Parameters	Closed loop			
If	[Encoder Type] $\mu E C P$	[SSI] $S S I$	[EnDat 2.2] $E n D 2 2$	[Resolver] $r E S$	[SinCos] $S C$
	Encoder usage $E n u$	[Speed Regulation] $r E G$			
Then	[Encoder type] $S C D 5$	SSI option module	EnDat2.2 option module	Resolver option module	SinCos option module
	[Encoder resolution] $S C D 6$	Must be set to [Turn bit resolution] $E n t r$ value	The number of bits per revolution must be entered manually	Must be set to the pole pair numbers (= [Resolver poles nbr] $r P P n / 2$)	Must manually be set to [SinCos lines count] $\mu E L C$ value
	[Encoder rotation inversion] $S C D 7$	<ul style="list-style-type: none"> Inactive: If [Encoder Rotation Inv.] $E n r i$ is set to [No] $n o$. Active: If [Encoder Rotation Inv.] $E n r i$ is set to [Yes] $y e s$. 			

	Parameters	Closed loop		
If	[Encoder Type] $\mu E C P$	[Hiperface] $S C H P$	[RS422] $R A b$	[HTL] $H T L$
	[Encoder usage] $E n u$	[Speed Regulation] $r E G$		
Then	[Encoder type] $S C D 5$	SinCos option module	AB or HTL option module	
	[Encoder resolution] $S C D 6$	The number of lines must be entered manually.	Must be set to [Number of pulses] $P G i$ value	
	[Encoder rotation inversion] $S C D 7$	<ul style="list-style-type: none"> Inactive: If [Encoder Rotation Inv.] $E n r i$ is set to [No] $n o$. Active: If [Encoder Rotation Inv.] $E n r i$ is set to [Yes] $y e s$. 		

The following table shows the settings of the encoder parameters according to the type of encoder and the type of control loop if an embedded encoder is used:

	Parameters	Closed loop	
If	[Emb Enc Type] $E E C P$	[AB] $R A b$	[SinCos] $S C$
	[Emb Enc Usage] $E E n u$	[Speed Regulation] $r E G$	
Then	[Encoder type] $S C D 5$	AB embedded	SinCos embedded
	[Encoder resolution] $S C D 6$	Must be set to [Emb Enc Pulses Nb] $E P G i$ value	Must be set to [Emb Enc SinCos lines] $E E L C$ value
	[Encoder rotation inversion] $S C D 7$	<ul style="list-style-type: none"> Inactive: If [Emb Enc Rotation Inv] $E E r i$ is set to [NO] $n o$. Active: If [Emb Enc Rotation Inv] $E E r i$ is set to [Yes] $y e s$. 	

Acceptance Test and Machine Signature

Overview

The system integrator/machine manufacturer performs a configuration test of the safety module to verify and document the correct selection of the parameter values. The system integrator/machine manufacturer hereby certifies to have tested the effectiveness of the safety functions used. The configuration test must be performed on the basis of the risk analysis. All applicable standards and regulations must be adhered to.

⚠ WARNING
<p>LOSS OF SAFETY FUNCTION</p> <p>Incorrect usage may cause a hazard due to the loss of the safety function.</p> <ul style="list-style-type: none"> • Verify that the engineering prerequisites still apply. • Carefully perform each individual step. • Document each individual step. <p>Failure to follow these instructions can result in death, serious injury, or equipment damage.</p>

The purpose of the test is to verify proper configuration of the defined safety functions and test mechanisms and to examine the response of dedicated monitoring functions to explicit input of values outside the tolerance limits.

The test must cover all drive-specific Safety configured monitoring functions and global Safety functionality of the drive with the safety module.

A configuration test of the safety module must be performed at the following points in time:

- After the configuration for each machine,
- After changes to parameter values,
- After changes to the machine (as per applicable standards and regulations).

Condition Prior to Acceptance Test

- The machine is wired up correctly.
- All safety-related devices such as protective door monitoring devices, light barriers, and emergency stop switches are connected and ready for operation.
- All motor parameters and command parameters must be correctly set on the drive.

Acceptance Test Process

Verify the effectiveness of all safety functions used.

Document each individual step of the test.

Note the checksum of the parameters (also known as the activation code) in your records. The checksum is automatically recorded in the safety report generated via SoMove.

Do not release the system unless the system has successfully passed all individual steps of the test.

NOTE: The safety configuration test function can help to test the safety functions, refer to **[Safety Config Test] 5 [E - menu** (*see page 107*).

Acceptance Report

SoMove creates the acceptance report.

This function provides a final report when one or several safety functions have been configured and verified. This report is deemed to be a machine signature and certifies that all the safety functions are operational. The acceptance report has been added as an optional document to be printed to a PDF file.

To generate the report, click on **Generate Safety Report** button in the **Safety Conf tab**. The report must only be generated if all individual steps of the test has successfully been passed.

If the drive configuration and/or the safety module configuration has/have been modified, you must repeat the acceptance tests.

Additional Features for The Commissioning

Password Configuration - Modify Password

This feature allows you to modify the password of the safety configuration. To modify the configuration password:

Step	Description
1	In the Safety Conf tab, click the Change Password button. It opens the Change Password dialog box.
2	<p>In the Change Password dialog box:</p> <ul style="list-style-type: none"> • Type the existing configuration password in the Current Password box. • Type the new configuration password in New Password box. • Retype the new configuration password in Re-Type New Password box. • Click OK <p>NOTE: The password must contain:</p> <ul style="list-style-type: none"> • 6 Characters, • At least 1 number • At least 1 alphabetical character, • At least 1 special character (such as !, *, ?, /, -)
3	<p>The password has been modified. Take carefully note of it.</p> <p>NOTE: The modification of the password is applied to the safety module at next transfer of the safety configuration.</p>

Edit a Safety Configuration

The safety configuration is in read-only mode if you open a safety conf file (.sft) or if you connect to a drive which already contains a safety configuration.

In order to modify the safety configuration inside the DTM, click on **Edit Configuration** button (in the **Safety Conf** tab). An **Enter Password** dialog box is displayed. Type the password of the safety configuration in **Enter Password** box then click on OK

Password Configuration - Reset Password

If you cannot remember the defined safety configuration password and if you cannot find it back, contact your Schneider Electric contact. Otherwise, the safety configuration must be reset in order to define a new password by clicking on **Reset** button (in the **Safety Conf** tab).

Reset The Safety Configuration

In the **Safety Conf** tab of the DTM, clicking the **Reset** button sets to factory settings all safety-related parameters. The reset function only resets the DTM dataset for the safety configuration. The current safety module configuration remains unchanged after this operation.

In **Complete Settings** → **Safety Module** menu of the Display Terminal, setting **[Safety Config Reset] 5 F r 5** to **[Yes] 4 E 5** resets the safety module configuration. The current drive configuration remains unchanged after this operation.

NOTE: The factory setting function of the drive, accessible in the menu **File management** → **Factory settings** only resets the drive configuration. The current safety module configuration remains unchanged after this operation.

Transfer The Safety Configuration

Clicking on **Transfer** button (in the **Safety Conf** tab), transfer the safety configuration done via the DTM to the connected drive.

The safety parameters set into the DTM are not written automatically in the connected drive. It is different from the online mode within there is a continuous writing of the standard parameters of the drive.

Before the transfer, verify the consistency of the safety configuration with the drive configuration (motor and encoder parameters).

The transfer cannot be performed if the drive is in operation enabled or if the function Forced Local is active.

At the beginning of the transfer, if a safety configuration is already loaded with a different password, to confirm the action it is requested to enter the password configuration of the safety configuration you are about to erase. Once the password is properly entered, the safety configuration is erased and the transfer is started.

Once a safety configuration is transferred, the safety configuration must be activated by entering the activation code into the drive via the Display Terminal. Then the acceptance tests must be performed.

Note:

- A transfer can be done if the safety configuration is in read-only.
- If the drive is powered off before entering the activation code successfully, the configuration of the safety module is removed and the drive triggers an error. The transfer must be performed again.
- If the cable has been disconnected during the transfer, the transfer must be performed again.

Generate Safety Report

This feature has been added as an optional document to be printed to a PDF file. It generates a safety report when one or several safety functions have been configured and verified.

It contains the activation code and information of the safety configuration. This report is deemed to be a machine signature and certifies that all the safety functions are operational.

The report must only be generated if all individual steps of the tests has successfully been passed.

If the drive configuration and/or the safety module configuration has/have been modified, the safety report is no more verified. The acceptance tests must be repeated, and the safety report must be generated again.

Generate Safety Report button is enabled in the following cases:

- Online, if the safety configuration has been transferred to the connected drive and activated. In this case, the button remains enabled even if the drive is disconnected to the commissioning software. However, in case of modification of the safety configuration displayed on the DTM, the button is disabled.
- Offline, if the current session uses a SoMove Project File (.psx) of a previously activated safety configuration. No modification of the configuration must have been performed. It is possible to generate the safety report in read-only mode.

Export The Safety-Configuration to PC - Open a Safety Configuration from PC

This feature is used to store the safety configuration in order to continue and/or transfer the configuration later. It can help save time.

This feature does not store the standard parameters of the drive. If you open a safety configuration file from PC, you must verify the consistency of the safety configuration with the drive parameters such as the motor and encoder parameters.

An exported/opened safety configuration is not approved, you must activate the safety configuration and perform acceptance tests in order to approve the safety configuration with your applications.

In the Safety Conf tab, during the safety configuration, if the safety configuration is consistent, the configuration can be stored into the PC by clicking **Export to PC** button. An Export file dialog box is opened. Choose the location to store the file. The type of filename extension is Safety Conf File (.sft).

In the **Safety Conf** tab, before starting to configure the safety, a safety configuration can be imported from the PC by clicking **Open** button. An **Import file** dialog box is opened. The type of filename extension to import is Safety Conf File (.sft). After selecting the configuration, you access to the configuration in read-only. To edit the configuration, you must enter the password configuration.

NOTE: If you connect to a drive which already contains a safety configuration, the **Safety Conf** tab do not display the **Open** button. To access the **Open** button, you must reset the safety configuration on the DTM by clicking on the **Reset** button.

NOTE: This Open/Export feature is different from the "Import"/"Export" and the "Store to Device"/"Load From Device" features proposed by SoMove ([see page 103](#)).

SoMove Project File Management

At any time of the configuration, the drive configuration can be saved with the safety configuration via **Save** or **Save as...** features. It can help save time in order to continue and/or transfer the entire configuration later.

The type of filename extension managed by this feature is a SoMove Project File (.psx).

To open a stored configuration, click on **Open Project** button and select the file.

A SoMove Project File is not approved, you must activate the safety configuration and perform acceptance tests in order to approve the SoMove Project File with your applications.

It is not possible to save the configuration if the safety configuration is not consistent.

Copying Safety-related Configuration

Overview

Only an approved configuration can be copied in several drives. An approved configuration includes the drive configuration and the safety module configuration.

A configuration is approved if the acceptance tests have been successfully completed with this configuration.

For more information, refer to "Configuration with the Commissioning Software" (*see page 93*) and refer to "Acceptance Test and Machine Signature" (*see page 99*).

To copy the approved configuration in several drives, it is possible to use:

- The commissioning software,
- The Display Terminal,
- The webserver.

Identify Unique Safety-related configuration

The identification of the safety configuration is done by using **[Activation Code] 5 C # C**. The calculation uses all safety-related parameters.

During a safety configuration transfer with the DTM, this code is displayed on a dialog box or at the bottom left of the **Safety Conf** tab.

You can get this activation code from the safety report.

This activation code is required to activate the safety configuration on a drive.

NOTE: The safety report of a cloned configuration can be generated by using the original approved configuration or the cloned configuration. The general information must be filled with the correct information.

Limitations

- A transfer or a copy of the configuration cannot be done if the drive is in operation enabled or if the function Forced Local is active.
- FDR and IPAR configuration transfers are not compatible with the use of the safety module.
- During a configuration transfer with the DTM, if a safety configuration is already loaded with a different password in the connected drive, you must enter the password configuration of the safety configuration you are about to erase to confirm the action. Once confirmed, the safety configuration is erased and the transfer is started.
- A configuration transfer (with a safety configuration) via the Display Terminal or via the webserver cannot be done if a safety configuration is already set and the safety configuration passwords are different. The safety configuration applied on the drive must be reset first.
- To clone a configuration (with a safety configuration) using a ".cfg" file, the configuration file must come from a configuration that has been validated by the commissioning software.
- The topology of the cloned drive must be identical to the transferred configuration. Nevertheless, the commissioning software can adapt the topology and the drive rating of the standard configuration of the drive but in this case, the approval of the configuration must be performed again.
- If the drive is powered off before entering the activation code successfully, the configuration of the safety module is removed. The application of the approved configuration must be performed again.
- If the cable has been disconnected during the application of the approved configuration via the commissioning software, the copy must be performed again.

To Manipulate an Approved Configuration

There are several ways to manipulate an approved configuration:

- **Copy from the drive** with the Display Terminal connected to the drive. A ".cfg" file is stored inside the Display Terminal.
- **Copy/Paste** the ".cfg" file from the Graphic Display Terminal to the computer. Once the copy of the configuration is done with the Graphic Display Terminal, you can connect via USB port the Graphic Display Terminal to the computer to copy/paste the ".cfg" file inside the computer.
- **Load from device** from the home page of the commissioning software. A ".cfg" or a ".psx" file is generated on the computer.
- **Load from device** with an opened session in the commissioning software. For this, connect the drive to the computer and click on **Load from device**. Instead of generating a file, this feature results in the opening of a session with the related configuration coming from the drive. You can save the project as a ".psx" file or export the configuration as a ".cfg" file.
- **Save/Save as...** with the commissioning software. Once the acceptance tests performed, you can save the project corresponding to the approved configuration via **Save/Save as...** functions. This action generates a ".psx" file on the computer.
- **Export** function with the opened project in the commissioning software (File > Import/Export > Export). Once the acceptance tests performed, you can export the approved configuration via the **Export** function. This action generates a ".cfg" file on the computer.
- **Export** function from the home page of the commissioning software to convert the ".psx" project file of an approved configuration in "a ".cfg" file.

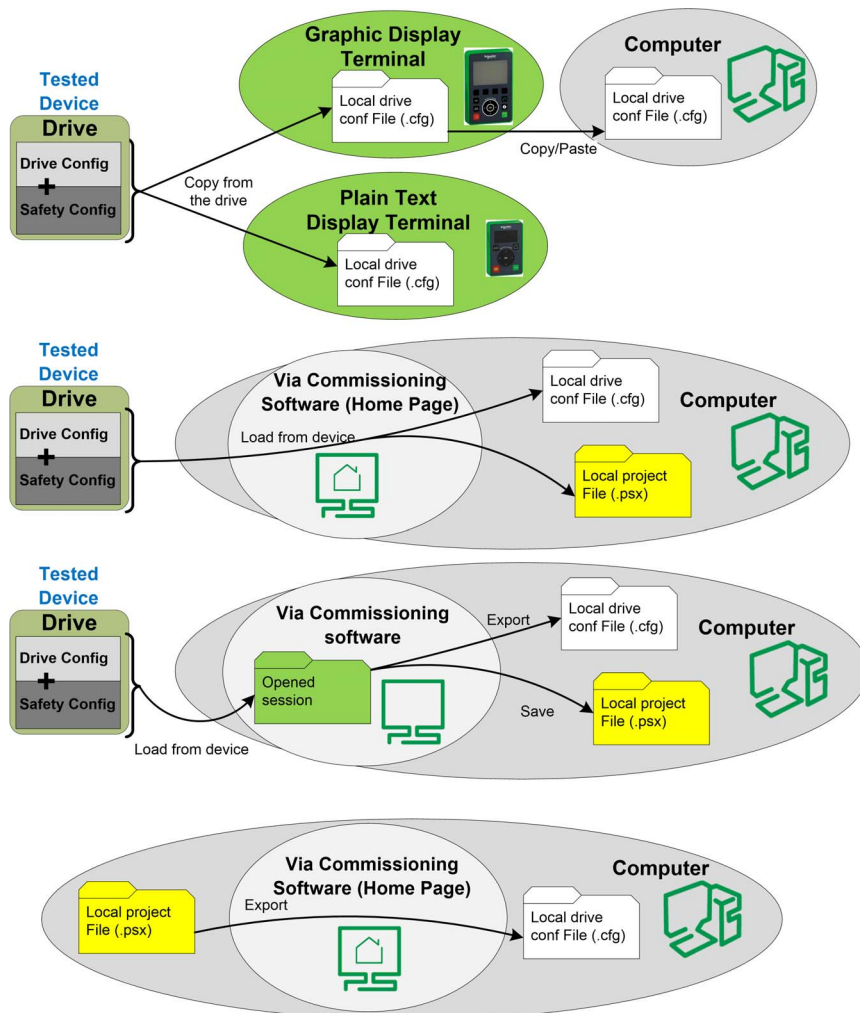

To Apply an Approved Configuration

Once an approved configuration is stored, it is possible to copy it to several drives. There are several ways to apply it to another drive:

- **Copy to the drive** with the Display Terminal connected to the drive. It uses a ".cfg" file stored in the Display Terminal.
- **Copy/Paste** the ".cfg" file from the computer to the Graphic Display Terminal. Once the copy/paste of the configuration is done with the Graphic Display Terminal, you can connect via USB port the Graphic Display Terminal to the drive to copy to the drive the ".cfg" file.
- **Store to device** from the home page of the commissioning software. The selected ".cfg" or ".psx" file is used by the commissioning software.
- **Open** the project file or import the configuration file of the approved configuration with the commissioning software then use the store to device to copy the approved configuration the other drive.
- **Copy from PC to device** via the webserver of the drive on which you want to copy the approved configuration. The ".cfg" file of the approved configuration is used.

Regardless of the method used, after the copy of the approved configuration, the activation code must be entered with the Display Terminal to activate the safety configuration on the drive. The activation code is identical to original safety configuration. The drive remains in STO until the activation has been entered successfully.

NOTE: Create a backup of the current configuration before applying a new one.

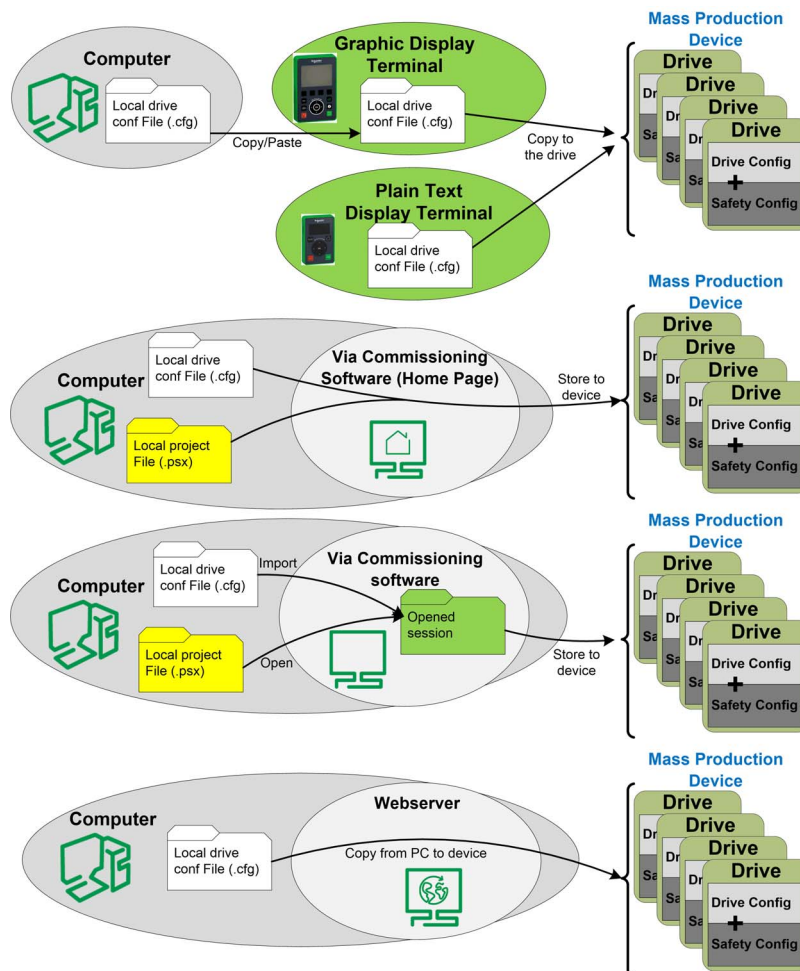

Display

LED Indicator

If the ASF LED of the drive is yellow flashing, monitoring of the frequency is active such as, SMS active or SS1 monitoring ramp active. If the ASF LED is yellow on, STO is active.

Safety Display Tab

The display tab shows the following information:

- At the top, there is the "error & safety functions status" showing the current safety module errors and the active safety function.
- Below, on the left, there is the pin layout of the safety module showing:
 - In grey, the supply power pin,
 - In white, the pin with 0V applied,
 - In blue, the pin with 24V applied.
- Below, on the right, it reminds the voltage applied to the inputs/outputs. Additionally, it shows in orange the safety function assigned to the inputs/outputs.

To visualize the voltage supplied to the inputs and the outputs, you must be connected to the drive with the DTM.

No password is required to access this information.

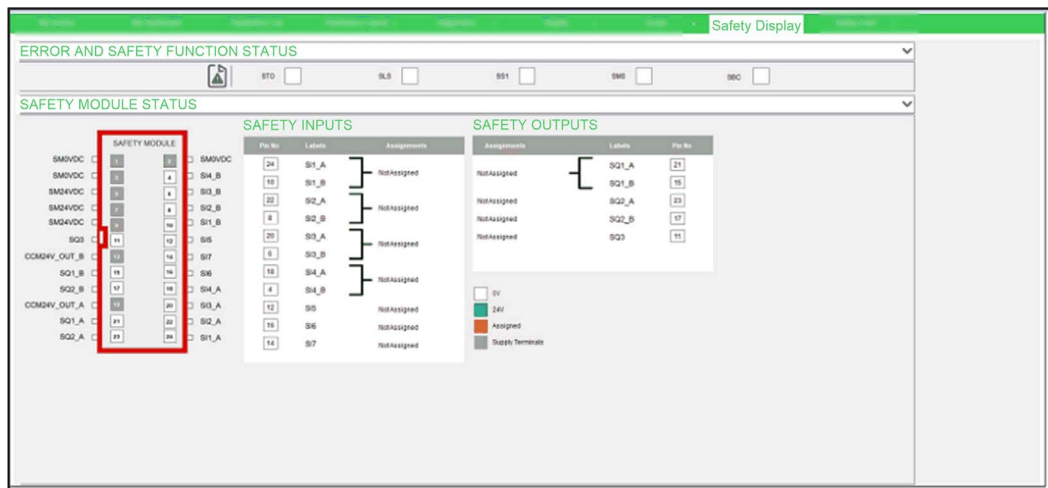

Real-time status of the safety module via the Display Terminal

In addition of the drive status ([Drive State] $H \Pi$, 5 parameter), there is a dedicated Safety Function menu in the Display Terminal called [Safety Module] $\alpha 5 \Pi$ - (see page 107). It allows you to display the real-time status of the safety module, the safety functions, the safety inputs/outputs and read the current safety module errors.

Status request via fieldbus

Via the fieldbus, read access to the status parameters of the safety module is possible. The parameters are accessed the same way as the parameters of the drive.

The states of the inputs and the outputs as well as the operating states of the safety module can be read via the fieldbus.

Reading a status message via the fieldbus may be subject to a time delay due to the asynchronous access to the parameters of a module.

Reading the values of these parameters cannot be approved for any type of safety-related use.

Dedicated Safety Function menu in the Display Terminal

Overview

If the safety module is inserted, the dedicated menu **[Safety Module] 0 5 7** - accessible via the Display Terminal is displayed. The menu access is:

[Complete settings] → [Safety Module]

This menu allows you to:

- Enable the safety module by entering the activation code,
- Visualize the real-time status of the safety module, the safety functions and the safety inputs/outputs,
- Reset the safety configuration,
- Read the current safety module errors,
- Test the safety functions with the Safety Config Test.

[Activation Code] 5 C R C

Activation Code.

It is composed by 4 characters (letters and digits).

Entering the activation code enables the safety module and its safety functions (**[Safety Config Status] 5 C R A** switches to **[Activated] A P r V**). Once the activation code validated, acceptance test must be done.

The activation code must be entered via a local connection.

The activation code is accessible if **[Safety Config Status] 5 C R A** is equal to **[Validated] V A L**. It means that the safety configuration has been transferred and this configuration has already been validated by the commissioning software.

After the activation code is entered at the Display Terminal, the drive may transition automatically to the operating state *Operation Enabled*. Depending on the wiring and the configuration of the drive, this may result in immediate operation.

WARNING

UNANTICIPATED EQUIPMENT OPERATION

- Verify that there are no persons or obstructions in the zone of operation before entering the activation code at the Display Terminal.
- Verify that you are fully aware of all consequences of entering the operating state *Operation Enabled*.

Failure to follow these instructions can result in death, serious injury, or equipment damage.

In case of transfer via the commissioning software, the activation code is displayed on the DTM inside the **Safety Conf** tab.

In case of configuration cloning, the activation code is displayed inside the safety report associated to the cloned configuration. It can also be displayed by connecting to the commissioning software inside the **Safety Conf** tab.

[Safety Module Status] 5 5 L R

Safety module status. This is a read-only parameter.

The safety module status is different from the drive status. Refer to Operating States and State Transitions (see page 115) for more information on the safety module status.

If the safety module is not activated ([Safety Config Status] 5 C n R is different from [Activated] R P r V), the safety module remains blocked in [Switch On Disabled] 5 o d.

NOTE: The safety module remains blocked in [Not Rdy to Switch On] n r 5 o if 24 Vdc supply power is not connected to the safety module.

Setting	Code / Value	Description
[Starting]	5 L r t	Starting.
[Not Rdy to Switch On]	n r 5 o	Not ready to switch on.
[Switch On Disabled]	5 o d	Switch on disabled.
[Ready to Switch On]	r t 5 o	Ready to switch on.
[Operation Enabled]	o P E n	Operation Enabled.
[Fault Reaction Active]	F r R C	Fault Reaction Active.
[Fault]	F L t	Fault.
[SS1 Active]	5 5 1	Safety function SS1 is active.
[STO Active]	5 t o	Safety function STO is active.

[Safety Config Status] 5 C n R

Safety configuration status. This is a ready-only parameter.

It allows to see if there is a safety configuration or if the safety configuration has been activated.

Setting	Code / Value	Description
[No Password]	n o P w	No password defined and no configuration. Factory setting.
[No Configuration]	n C n F	Password defined but no configuration.
[Not Validated]	n V R L	Configuration not validated by the commissioning software.
[Validated]	V R L	Safety module validated, it needs to be activated (with the activation code).
[Activated]	R P r V	Safety module activated.

[Active Safety Fct] 5 F C R

Active safety function. This is a ready-only parameter.

It shows which safety function is active.

If the safety function SMS and another safety function are active at the same time, the other safety function is shown with this parameter.

Setting	Code / Value	Description
[None]	F 0 0 1	No safety function is active.
[STO]	F 0 0 0	Safety function STO is active.
[SLS]	F 0 0 3	Safety function SLS is active.
[SS1]	F 0 0 5	Safety function SS1 is active.
[SMS]	F 0 0 8	Safety function SMS is active.

[Min Observable Freq] 5 F Π n

Minimum observable motor frequency. This parameter is a read-only parameter.

This parameter shows the maximum frequency reaches by the estimated minimum observable motor frequency. The estimation is reset at each power-on and after the activation of a safety configuration.

The setting value of frequency parameters (such as standstill levels) should be greater than this estimated parameter value to help prevent errors linked to a non-observable frequency (*see page 85*).

This parameter can be accessed if:

- **[Safety Config Status] 5 C n R** is equal to **[Activated] A P r V**, and
- **[Access Level] L R C** is set to **[Expert] E P r**.

Setting	Code / Value	Description
[Not Measured]	<i>u n K</i>	Not measured. Factory setting: -
0...3,276.7 Hz		Range.

[Safety Config Reset] 5 F r 5

Reset of the safety configuration. It resets only the parameters related to the safety module. In this case, **[Safety Config Status] 5 C n R** will be modified to **[No Password] n o P W**.

This parameter can be accessed if **[Access Level] L R C** is set to **[Expert] E P r**.

Setting	Code / Value	Description
[No]	<i>n o</i>	Not active.
[Yes]	<i>Y E 5</i>	Request to reset the safety configuration.

[Safety Input Map] 5 L ,

It presents the state of the safety module inputs. Read-only parameter.

SI1_A, SI1_B, SI2_A, SI2_B, SI3_A, SI3_B, SI4_A, SI4_B, SI5, SI6, SI7

[Safety Output Map] 5 L o

It presents the state of the safety module outputs. Read-only parameter.

SQ1_A, SQ1_B, SQ2_A, SQ2_B, SQ3

[Safety Module Errors] 5 Π E - menu

This menu contains additional information about the current detected errors related to the safety module by.

- **[Safety Module Error] 5 Π L E**, and/or
- **[Safety Module Error 0] 5 Π E D** to **[Safety Module Error 9] 5 Π E 9**.

The list of error codes is available in the section Detected Error (*see page 117*).

[Safety Config Test] 5 C t - menu

This menu can be accessed if **[Access Level] L R C** is set to **[Expert] E P r** and if **[Safety Config Status] 5 C n R** is equal to **[Validated] V R L**.

This menu gives access to the safety configuration test function. This function can help during the tests of your safety configuration. It is used to:

- substitute the deceleration commanded ramp set by the safety module by **[Test Ramp Cmd] F 5 r C** value if configured, and
- ignore the limitation to the set point requested by the safety module by the reference frequency set by the drive application.

Once the acceptance tests are done, this function must be disabled by setting **[Test Ramp Activation] F 5 C R** to **[Not Assigned] n o**.

NOTE: After a power cycle, the setting of the parameters **[Test Cmd Activation] F 5 C R** and **[Test Ramp Cmd] F 5 r C** is reset.

Status of the drive

This function only operates if the digital input or the virtual digital input assigned to **[Test Cmd Activation] F 5 C R** is activated and if the safety module gives the frequency reference to reach or a deceleration commanded ramp to follow (e.g. if the safety function SS1 or the safety function SLS is operating).

if the digital input or the virtual digital input assigned to **[Test Cmd Activation] F 5 C R** is activated, **[Drive State] H P , S** displays **[Safety Config Test] S C L P**

Parameters

Parameter	[Test Cmd Activation] F 5 C R
Description	Configure the digit input or the virtual digital input assigned to the activation of the safety configuration test function. NOTE: This parameter can only be modified if the motor is not running.
Setting	<ul style="list-style-type: none"> • [Not Assigned] n a: Not assigned (Factory Setting) • [Yes] Y E S: Function always active • [D1] L , I ... [D18] L , B: Digital input DI1...DI8 (depending on the product number of the drive) • [D11] L , I I ... [D16] L , I B: Digital input DI11...DI16 if VW3A3203 I/O extension module has been inserted • [CD00] C d 0 0 ... [CD10] C d 1 0: Virtual digital input CMD.0...CMD.10 in I/O profile IO configuration • [CD11] C d 1 1 ... [CD15] C d 1 5: Virtual digital input CMD.11...CMD.15 regardless of configuration • [C111] C 1 1 1 ... [C115] C 1 1 5: Virtual digital input CMD1.11...CMD1.15 with integrated Modbus Serial regardless of configuration • [C101] C 1 0 1 ... [C110] C 1 1 0: Virtual digital input CMD1.01...CMD1.10 with integrated Modbus Serial in I/O profile IO configuration • [C201] C 2 0 1 ... [C210] C 2 1 0: Virtual digital input CMD2.01...CMD2.10 with CANopen® fieldbus module in I/O profile IO configuration • [C211] C 2 1 1 ... [C215] C 2 1 5: Virtual digital input CMD2.11...CMD2.15 with CANopen® fieldbus module regardless of configuration • [C301] C 3 0 1 ... [C310] C 3 1 0: Virtual digital input CMD3.01...CMD3.10 with a fieldbus module in I/O profile IO configuration • [C311] C 3 1 1 ... [C315] C 3 1 5: Virtual digital input CMD3.11...CMD3.15 with a fieldbus module regardless of configuration • [C501] C 5 0 1 ... [C510] C 5 1 0: Virtual digital input CMD5.01...CMD5.10 with integrated Ethernet in I/O profile IO configuration ((This selection can be accessed on ATV340...N4E drives). • [C511] C 5 1 1 ... [C515] C 5 1 5: Virtual digital input CMD5.11...CMD5.15 with integrated Ethernet regardless of configuration (This selection can be accessed on ATV340...N4E drives).

Parameter	[Test Ramp Cmd] F 5 r C
Description	Configure the deceleration commanded ramp replacing the one requested by the safety module. This parameter is forced to [No] n a if [Test Cmd Activation] F 5 C R is set to [Not Assigned] n a .
Setting	<ul style="list-style-type: none"> • [No] n a: Not used (Factory Setting) • 0.1 Hz/s up to 20,000 Hz/s (step: 0.1 Hz/s): Setting range

Behavior of the function with SS1

During SS1 operation, if the safety configuration test function is activated (the input or bit assigned to **[Test Cmd Activation] F5rL** switches to high-level), the deceleration is done following **[Test Ramp Cmd] F5rL**. The following figure shows this behavior.

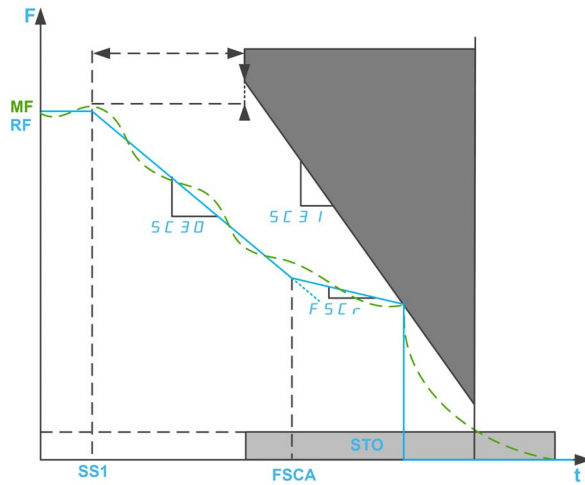

F: Frequency / **MF:** Motor Frequency / **RF:** Reference Frequency

SS1: activation of SS1

FSCA: activation of the safety configuration test function

If the safety configuration test function is activated before SS1 activation, then at SS1 activation, the deceleration is immediately done following **[Test Ramp Cmd] F5rL**.

NOTE: if the parameter **[SS1 drive control] SC3B** of the safety function SS1 is set to External or if the parameter **[Test Ramp Cmd] F5rL** is set to **[No] n0**, this function has no effect during SS1 operation.

Behavior of the function with SLS

During SLS operation, if the safety configuration test function is activated, then reference frequency applied to the motor is set by the application of the drive. In case of deceleration, if the reference frequency greater than **[SLS positive set point] SC50** and if **[Test Ramp Cmd] F5rL** is different from **[No] n0** the deceleration follows **[Test Ramp Cmd] F5rL** value else the deceleration is done following the application deceleration.

The following figure shows an example with SLS type 2.

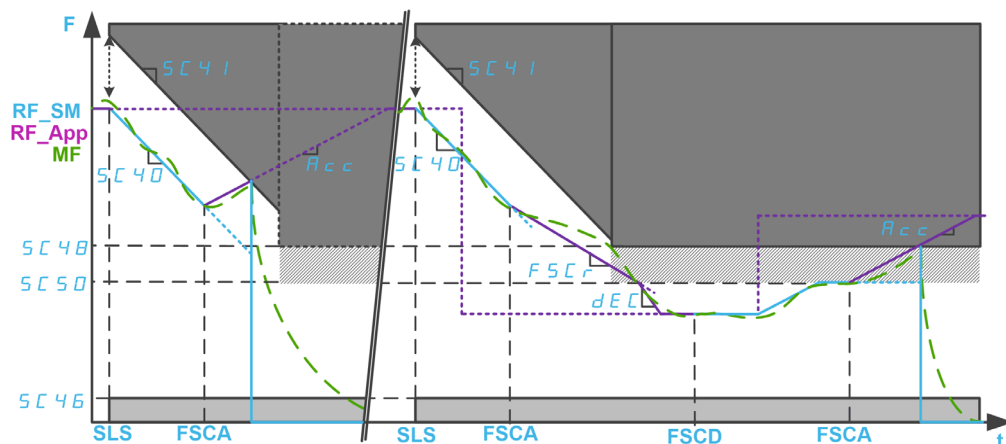

F: Frequency / **MF:** Motor Frequency

RF_SM: Reference Frequency set by the safety module / **RF_APP:** Reference Frequency set by the application of the drive

ACC: Acceleration / **DEC:** Deceleration

SLS: activation of SLS

FSCA/FSCD: activation/deactivation of the safety configuration test function

Chapter 7

Diagnostics and Troubleshooting

What Is in This Chapter?

This chapter contains the following topics:

Topic	Page
Monitoring Functions	114
Operating States and State Transitions	115
Detected Errors	117
FAQ	123

Monitoring Functions

Simultaneous Switching

If signal pairs (channel A and channel B) switch to a different state, the safety module checks whether both inputs change to the same state within a fixed time window of 1.8 s, if not an error is triggered. Contact welding or short circuits to other voltage carrying conductors can be the causes of such errors.

Serial Number Test

When the 24 V supply to safety module is enabled, drive sends the serial number to the safety module. The safety module operates only if it receives the correct drive serial number. This test is performed to make sure that parametrized safety module retains the parameter values when plugged into a different drive.

Checking The Supply Voltage

If the supply voltage of the safety module exceeds the permissible range, the safety function SS1 is triggered. The safety-related outputs are switched off and an error triggered.

Temperature Monitoring

If the temperature of the safety module exceeds the permissible range, the safety function STO is triggered. The safety-related outputs are switched off. An error is signaled.

This error can only be reset by switching off and switching on the supply voltage of the drive controller after the cause of the error has been removed.

Operating States and State Transitions

Operating States

The table provides the different operating states for safety module:

States	Name	Description
0	Starting	
1	Not Ready to Switch on	Indicates that the safety module initialization completed
2	Switch On Disabled	Indicates that the 24 V power supply is connected to the safety module.
3	Ready to Switch On	Indicates that the 24 V power supply is turned on but power stage is locked.
5	Operation Enabled	Indicates that the power stage is released using start signal and safety module is in the operating mode.
7	Error Reaction Active	Indicates that an error class 2 is detected and SS1 is activated.
8	Error	Indicates that the detected error is triggered and STO is activated
10	Safety Function SS1	Indicates that the safety function SS1 is triggered (for example, due to the emergency stop via an actuator).
11	Safety Function STO	Safety function STO is activated

NOTE: The safety module operating state machine is different from the drive operating state machine.

State Transitions

The following figure shows the state transition diagram for safety module.

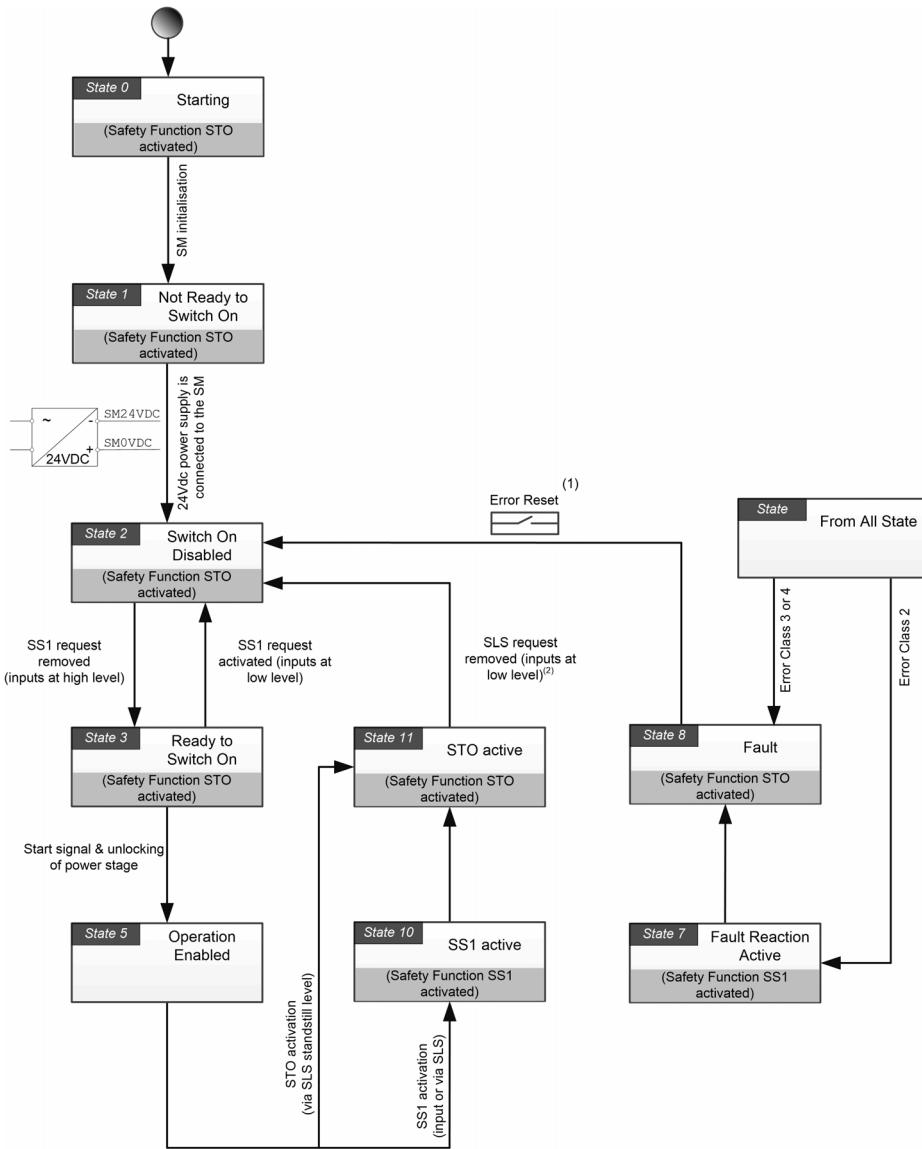

(1): In case of the non-resettable error, power off and on the device.
 (2): Remove SLS request in case of STO activation via SLS standstill level or SS1 activation via SLS threshold

Detected Errors

Overview

The safety-related errors are classified as follows

- **S I O F**: Safety-related IO errors
- **S F V F**: Safety function violation error
- **S C F F**: Safety-related configuration error
- **S M F**: Safety module detected error

When an error is detected by the safety module, the drive displays one of the previous errors depending on the cause(s).

This detected error is completed with one or several error codes in order to provide more information on the probable causes and remedies (refer to the table related to each error for more information on the main error codes).

The error codes can be accessed by scrolling at the bottom of the window displayed on the Display Terminal when an error is triggered. They can also be accessed in the menu **Complete Settings → Safety Module → Safety Module Error** or via the Safety Display tab of the commissioning software.

NOTE: If several detected error codes are detected, the first detected error code defined which safety-related error will be triggered.

Error Class

The safety module triggers errors. The errors can be grouped by classes as following:

Error Class	Stop category (as per IEC 60204)	Description
0	–	Warning: an event has been detected. No interruption of the movement.
2	1	An error has been detected by the safety module. The safety function SS1 is triggered and the power stage is disabled when SS1 standstill level has been reached. During a SS1 response with error, the SMEx error codes are filled with the current error but the state of the drive remains SS1 (and the state of the safety module remains Fault Reaction Active) until both of the following events are verified: SQ1 is deactivated and SS1 standstill level is reached (parameter SC33), then the drive triggers an error. Error class 2 are resettable.
3	0	An error has been detected. The safety function STO is triggered and the power stage is immediately disabled. Errors class 3 are resettable.
4	0	An error has been detected. The safety function STO is triggered and the power stage is immediately disabled. Errors class 4 are non-resettable.

Error Reset

Resettable error: after the cause has been removed, this detected error can be cleared manually via the use of the digital input or control bit set to the **[Fault reset] r 5 L -** function. The detected error can also be cleared by a power cycle of the drive or a product restart.



Non-resettable error: After removing the cause, this detected error requires a power reset of the drive to be cleared.



Note:



- If a resettable error and a non-resettable error are detected at the same time, the non-resettable error cannot be reset manually. After removing the causes, these detected errors require a power reset of the drive to be cleared.
- If an error is triggered by the safety module, this information is shared with the drive. An error can also be triggered by the drive. In case both the drive and the safety module trigger an error and if the detected errors can be cleared manually, the clear of a detected error must be done twice. The causes of the error detection may be the identical.

5 I O F Errors

The table provides the list **5 I O F** detected errors



Error Code	Decimal value	Probable Cause 	Remedy 	Error Class
[SQxA 0V S/C] 5NE01F	31	Outputs channel A short circuit against 0V	Verify wiring.	2
[SM24VDC Overvolt] 5NE020	32	External 24V exceeds upper limit	Verify wiring and power supply.	4
[SM24VDC Undervolt] 5NE021	33	External 24V exceeds lower limit	Verify wiring and power supply.	4
[Start Pulse Too Long] 5NE022	34	Start on Pulse: pulse duration exceeds 2 s. Welded contact on start signal.	Verify wiring.	2
[SIx/A/B Lvl Different] 5NE029	41	Different input levels between channel A and channel B detected	Verify wiring.	4
[SQx/A/B Lvl Different] 5NE02A	42	Different output levels between channel A and channel B detected	Contact your Schneider Electric Customer Care Center (CCC).	2
[Start Input At 0V] 5NE034	52	Before enabling the Safety Module on level, the start input must be at 24V.	Verify that there is no welded contact connected to the start input.	2
[Start Input At 24V] 5NE035	53	Before enabling the Safety Module on pulse, the start input must be at 0V.	Verify that there is no welded contact connected to the start input.	2
[SQ2A 24V S/C] 5NE03b	59	SQ2A short circuit 24V	Verify wiring.	2
[SQ3 24V S/C] 5NE03c	60	SQ3 short circuit 24V	Verify wiring.	2
[SQ1A 24V S/C] 5NE03d	61	SQ1A short circuit 24V	Verify wiring.	2
[CCM24V_A 24V S/C] 5NE03E	62	CCM24V_A short circuit 24V	Verify wiring.	2
[SQxB 0V S/C] 5NE04B	72	SQxB short circuit 0V	Verify wiring.	2
[SQ2B S/C vs Output] 5NE04F	79	SQ2B short circuit against another output	Verify wiring.	2
[SQ3 S/C vs Output] 5NE050	80	SQ3 short circuit against another output	Verify wiring.	2
[SQ1B S/C vs Output] 5NE051	81	SQ1B short circuit against another output	Verify wiring.	2
[CCM24V_B S/C vs Output] 5NE052	82	CCM24V_B short circuit against another output	Verify wiring.	2
[SQ2B 24V S/C] 5NE053	83	SQ2B short circuit 24V	Verify wiring.	2
[SQ3 24V S/C] 5NE054	84	SQ3 short circuit 24V	Verify wiring.	2
[SQ1B 24V S/C] 5NE055	85	SQ1B short circuit 24V	Verify wiring.	2
[CCM24V_B 24V S/C] 5NE056	86	CCM24V_B short circuit 24V	Verify wiring.	2
[Internal 24V OverV] 5NE060	96	Internal 24VDC overvoltage.	Contact your Schneider Electric Customer Care Center (CCC).	2
[SI7 at 24V] 5NE06A	106	SI7 input detected at 24V while unassigned.	If SI7 is required for your application, it must be configured. Otherwise, it must remain at 0V.	2
[Internal 24V UnderV] 5NE06d	109	Internal 24VDC undervoltage.	Contact your Schneider Electric Customer Care Center (CCC).	2

Error Code	Decimal value	Probable Cause 	Remedy 	Error Class
[SinCos Embed Signal] 5NE070	112	SinCos embedded signal. Detected error on encoder signals.	Verify the encoder and its wiring.	3
[SinCos Opt Signal] 5NE093	147	SinCos option module signal. Detected error on encoder signals.	Verify the encoder module, the encoder and its wiring.	3
[Encoder Error] 5NE094	148	Encoder error.	Verify the encoder module, the encoder and its wiring.	3
[Enc Signal Overcur] 5NE095	149	Encoder signal overcurrent.	Verify the encoder module, the encoder and its wiring.	3
[Encoder Signal Spike] 5NE096	150	Encoder signal spike.	Verify the encoder module, the encoder and its wiring.	3
[SBC Fdback Timeout] 5NE0A0	160	SBC feedback signal not detected on time.	<ul style="list-style-type: none"> Verify SBC feedback delay is consistent with SBC bouncing. Verify SBC command and SBC feedback circuits. Verify the brake(s) used for SBC function. 	3
[SQ2A S/C vs Output] 5NE0AE	174	SQ2A short circuit against another output	Verify wiring.	2
[SQ3 S/C vs Output] 5NE0AF	175	SQ3 short circuit against another output	Verify wiring.	2
[SQ1A S/C vs Output] 5NE0b0	176	SQ1A short circuit against another output	Verify wiring.	2
[CCM24V_A S/C vs Output] 5NE0b1	177	CCM24V_A short circuit against another output	Verify wiring.	2
[Enc Channel A Open] 5NE0b9	185	Encoder channel A is open	Verify the encoder module, the encoder and its wiring.	3
[Enc Channel B Open] 5NE0bA	186	Encoder channel B is open	Verify the encoder module, the encoder and its wiring.	3
[Endat RCV1 Error] 5NE0bd	189	Endat RCV1 error	Verify the encoder module, the encoder and its wiring.	4
[Endat ERR1 Error] 5NE0bE	190	Endat ERR1 error	Verify the encoder module, the encoder and its wiring.	4
[Endat CRCPTY Error] 5NE0bF	191	Endat CRCPTY error	Verify the encoder module, the encoder and its wiring.	4
[Endat MSADR Error] 5NE0c0	192	Endat MSADR error	Verify the encoder module, the encoder and its wiring.	4
[Endat ERR2 Error] 5NE0c1	193	Endat ERR2 error	Verify the encoder module, the encoder and its wiring.	4
[Endat WDOG Error] 5NE0c2	194	Endat watchdog error	Verify the encoder module, the encoder and its wiring.	4
[Endat Power Error] 5NE0c3	195	Endat power error	Verify the encoder module, the encoder and its wiring.	4
[Resolver Speed Error] 5NE0c9	201	Speed exceeds maximum tracking rate	Verify the encoder module, the encoder and its wiring.	4
[Resolver Signal Error] 5NE0cb	203	Sine signal and Cosine signal are inconsistent	Verify the encoder module, the encoder and its wiring.	4
[Resolver Signal Error] 5NE0cc	204	Sine signal or Cosine signal is out of range	Verify the encoder module, the encoder and its wiring.	4
[Resolver Signal Error] 5NE0cd	205	Sine signal or Cosine signal is lost	Verify the encoder module, the encoder and its wiring.	4
[Resolver Signal Error] 5NE0ce	206	Sine signal or Cosine signal is clipped	Verify the encoder module, the encoder and its wiring.	4

Error Code	Decimal value	Probable Cause 	Remedy 	Error Class
[Unexpected STO] <i>SNE014</i>	212	<ul style="list-style-type: none"> STO is requested from Drive terminal. The safety module has detected an error on STO circuitry. 	<ul style="list-style-type: none"> Verify that drive STO_A and STO_B are wired to 24V. Contact your local Schneider Electric representative. 	3
[AB Emdb Wirebreak] <i>SNE0E2</i>	226	AB embedded encoder wirebreak.	Verify the encoder and its wiring.	3



SAVF Errors

The table provides the list SAVF detected errors

Error Code	Decimal value	Probable Cause 	Remedy 	Error Class
[SS1 Ramp Violation] <i>SNE011</i>	17	Insufficient motor deceleration during SS1	<ul style="list-style-type: none"> Verify the drive and machine configuration. Verify the motor frequency. 	3
[Low Temp Warn] <i>SNE01C</i>	28	Temperature exceeds lower limit (warning).	Verify environment temperature	0
[High Temp Warn] <i>SNE01d</i>	29	Temperature exceeds upper limit (warning).	Verify environment temperature	0
[Motor Freq Deviation] <i>SNE02C</i>	44	The monitored motor frequency is different channel A and channel B.	<ul style="list-style-type: none"> Verify the safety module motor and encoder parameters. Verify the drive control loop settings. Replace the safety Module. 	3
[Low Freq Settings] <i>SNE04b</i>	75	Low frequency settings.	Contact your Schneider Electric Customer Care Center (CCC).	3
[Low Temp Error] <i>SNE05F</i>	95	Temperature exceeds lower limit.	Verify environment temperature.	4
[High Temp Error] <i>SNE061</i>	97	Temperature exceeds upper limit.	Verify environment temperature.	4
[SS1 Repeat Violation] <i>SNE06B</i>	104	Maximum number of SS1 ramp violations has been reached	<ul style="list-style-type: none"> Verify the drive and machine configuration. Verify the motor frequency. 	4
[SMS Pos Violation] <i>SNE07B</i>	120	Motor frequency exceeds SMS positive threshold (violation response: SS1 with error)	<ul style="list-style-type: none"> Verify the drive and machine configuration. Verify the motor frequency. 	2
[SMS Neg Violation] <i>SNE0A2</i>	162	Motor frequency exceeds SMS negative threshold (violation response: SS1 with error)	<ul style="list-style-type: none"> Verify the drive and machine configuration. Verify the motor frequency. 	2
[Monit Ramp Violation] <i>SNE0A9</i>	169	Insufficient motor deceleration during monitored ramp	<ul style="list-style-type: none"> Verify the drive and machine configuration. Verify the motor frequency. 	3
[SLS Thd Violation] <i>SNE0Ab</i>	171	Motor frequency exceeds SLS threshold	<ul style="list-style-type: none"> Verify the drive and machine configuration. Verify the motor frequency. 	3
[SMS Pos Violation] <i>SNE0b4</i>	180	Motor frequency exceeds SMS positive threshold (violation response: STO with error)	<ul style="list-style-type: none"> Verify the drive and machine configuration. Verify the motor frequency. 	3
[SMS Neg Violation] <i>SNE0b5</i>	181	Motor frequency exceeds SMS negative threshold (violation response: STO with error)	<ul style="list-style-type: none"> Verify the drive and machine configuration. Verify the motor frequency. 	3
[Unallowed IGBT Test] <i>SNE0dC</i>	220	Unallowed IGBT tests have been detected by safety module	Contact your Schneider Electric Customer Care Center (CCC).	3

5 C F F Errors

The table provides the list 5 C F F detected errors



Error Code	Decimal value	Probable Cause 	Remedy 	Error Class
[Config Dwnld Timeout] 5 N E D 1 9	25	Transfer error between drive and module.	Try downloading the configuration again.	0
[Config Dwnld Error] 5 N E D 1 b	27	Configuration download error.	Contact your Schneider Electric Customer Care Center (CCC).	0
[Conf Transfer Aborted] 5 N E D 2 d	45	Configuration transfer aborted.	Contact your Schneider Electric Customer Care Center (CCC).	3
[Corrupted Config] 5 N E D 3 e	50	Corrupted configuration.	Contact your Schneider Electric Customer Care Center (CCC).	4
[Low Freq Settings] 5 N E D 4 9	73	Low frequency settings.	Contact your Schneider Electric Customer Care Center (CCC).	3
[Incompatible Version] 5 N E D 4 9	217	The safety module software and the drive software are incompatible.	<ul style="list-style-type: none"> Verify the compatibility software version of the drive and the safety module. Contact your local Schneider Electric representative. 	4
[Motor Ph Inversion] 5 N E D 4 A	218	Safety module and Drive motor phase inversion configurations are inconsistent.	Verify safety module and drive configuration.	3
[Encoder Inversion] 5 N E D 4 b	219	Safety module and Drive encoder inversion configurations are inconsistent.	Verify safety module and drive configuration.	3
[Incompat Enc Option] 5 N E D F 3	243	Encoder module is incompatible with safety module.	Contact your Schneider Electric Customer Care Center (CCC).	4
[Board Compatibility] 5 N E D F 4	244	Drive control board is incompatible with safety module.	Contact your Schneider Electric Customer Care Center (CCC).	4

The following table shows the dedicated errors displayed via [Safety Module Error] 5 N L E parameter:

- [Partial Conf Transfer 2] n o C F
- [Partial Conf Transfer 1] n S C F
- [Pairing Error 1] w C F
- [Pairing Error 2] w S C F
- [Invalid Motor Conf] w C C F

INF Errors

The table provides the list of **INF** detected errors

Error Code	Decimal value	Probable Cause 	Remedy 	Error Class
[Sfty Fct in Freewheel] <i>S P E D 7 I</i>	113	Safety function activated in freewheel.	Contact your Schneider Electric Customer Care Center (CCC).	3
[Incoherent Mot Curr] <i>S P E D d F</i>	223	Incoherent Motor Current.	Contact your Schneider Electric Customer Care Center (CCC).	4
[Motor Freq Deviation] <i>S P E D E D</i>	224	Motor Frequency Deviation.	Contact your Schneider Electric Customer Care Center (CCC).	4
[Motor Overcurrent] <i>S P E D E C</i>	236	Motor Overcurrent.	Contact your Schneider Electric Customer Care Center (CCC).	4

The following table shows the dedicated errors displayed via **[Safety Module Error] S P L E** parameter:

- **[Internal Com Error 1]** *C r C R*
- **[Internal Com Error 2]** *C r C C*
- **[Internal Com Error 3]** *W t b*
- **[Internal Conf Error]** *P C n F*
- **[Conf Download Error1]** *d S E 9*
- **[Conf Download Error2]** *V S E 9*
- **[Conf Download Error3]** *d C n F*

FAQ

Safety Module Firmware Update

The firmware of the safety module cannot be updated.

Application of a Configuration on a Drive Which Has a Safety Module

It is not possible to apply or transfer a configuration which does not include a safety configuration or for which the safety module is not configured on a drive which has a safety module.

Transfer of The Safety Configuration Alone

Except for the transfer function (via the **transfer** button), the safety configuration is always transferred with the drive configuration.

Modification of The Topology: insertion of The Safety Module

If **[Motor Control Type] C L E** is set to a value incompatible with the use of a safety module, an error is triggered. With permanent magnet synchronous motors, if **[Boost Activation] b o A** and **[Boost] b o o** are set to value incompatible with the use of a safety module, their setting values are automatically modified.

Removing the safety module does not set back the parameters to their previous value.

Refer to Compatibility and Precedence of Safety Functions and Non-Safety-Related Functions for more information on the compatible settings (*see page 87*).

To help prevent unwanted setting modification, insert the safety module before starting the configuration of the drive. However, to perform some actions with the drive (such as autotuning) the safety configuration must be activated.

Safety Module Configuration and STO

The drive remains in STO until a safety module configuration has been transferred and activated (i.e. **[Safety Config Status] S C n A** equals to **[Activated] A P r V**).

Motor Tuning and Safety Module

With a safety module inserted, a tuning of the motor can only be done if the safety module has been successfully configured (i.e. **[Safety Config Status] S C n A** equals to **[Activated] A P r V**) and if the safety module has unlocked enabling of the power stage (**[Safety Module Status] S S L A** equals to **[Operation Enabled] o P E n**).

Remove or Replace The Safety Module

If the safety module is configured and activated in a drive, the drive and the safety module are "linked".

If you want to remove or replace the safety module, create a backup of the current configuration then perform a reset of the safety configuration via **[Safety Config Reset] S F r S** (*see page 109*) before removing the safety module.

In case of module replacement, insert a safety module in factory settings to help prevent unexpected error and behavior.

If a safety module is removed from a drive, the drive locks in incorrect configuration CFF error at power-on. If the safety module has been deliberately changed or removed, the detected error can be cleared by pressing the OK key twice, which causes the factory settings of the configuration related to the module removed to be restored. Otherwise, power-off the drive and insert back the safety module.

To reuse a removed safety module, a reset of its configuration must be performed first if it has not been already done before removing it. Insert this module within a drive. At next power-on of the drive, a **[Safety Config Error] S C F F** is triggered. Perform a reset of the safety configuration via **[Safety Config Reset] S F r S** (*see page 109*). Then the configuration of the safety module can be performed again.

If the drive was not in error, it means either:

- The safety module was already not configured, or
- The drive was already configured with another safety module. In this case, perform a reset of the safety configuration via **[Safety Config Reset] S F r S** before starting a new configuration.

NOTE: After inserting a safety module within a drive, if **[Safety Config Status] S C n A** is different from **[No Password] n o P w** perform a reset of the safety configuration via **[Safety Config Reset] S F r S** before starting a new configuration.

Detection of SIOF Error When The Safety Module Unlocks Enabling of The Power Stage

First, verify the error code linked to the error SIOF. If there is an error code **[Unexpected STO] 5 1 E 0 1 4**, verify the wiring of the STO inputs of the drive. In case the STO inputs are not wired to the 24V supply.

The embedded STO function of the drive cannot be used standardly with the safety module. If a STO is requested via the STO inputs of the drive and it is inconsistent with the monitoring of the safety module, an error is triggered (i.e. the safety module does not request STO).

The Safety Module Remains in The Operating State Switch on Disabled

Verify the 24V supply voltage is connected to the safety module (SM24VDC and SM0VDC).

