

PowerPact™ P-Frame Circuit Breaker Data Sheets



What's in This Document

PowerPact P-Frame General Information	2
PowerPact P-Frame Codes/Standards	2
PowerPact P-Frame Interrupting Ratings	3
PowerPact P-Frame Continuous Current Rating	3
PowerPact P-Frame Automatic Molded Case Switches	4
PowerPact P-Frame Motor Circuit Protectors	5
PowerPact P-Frame Electrically-Operated Circuit Breakers	5
PowerPact P-Frame Application Information	6
PowerPact P-Frame Operation Ratings	7
PowerPact P-Frame Trip Unit Details	7
PowerPact P-Frame Trip Curves	13
PowerPact P-Frame Common Accessories	14

PowerPact P-Frame General Information

PowerPact™ P-frame electronic trip molded case circuit breakers are designed to protect electrical systems from damage caused by overloads, short circuits, and ground faults. All circuit breakers are designed to open and close a circuit by nonautomatic means and to open the circuit automatically on a predetermined overcurrent. Electronic trip molded case circuit breakers use an electronic trip system to signal the circuit breaker to open automatically.

The PowerPact P-frame (1200 A frame size) circuit breakers are dual rated to UL489 and IEC 60947-2.

P-frame molded case circuit breakers are available with either a basic ET 1.0I electronic trip system or with a more advanced Micrologic™ trip system. Electronic trip motor circuit protectors (trip system ET 1.0M), which trip on short circuit only, and automatic molded case switches, which trip at a predetermined self-protection level only, are also available for special applications. All of these circuit breakers are available labeled as Square D™ or Schneider Electric™ (formerly Merlin Gerin™, Federal Pioneer™, or Federal Pacific™).

- Both standard (80%) and 100% rated construction circuit breakers are available in 1200 A with a sensor size range of 250–1200 A.
- Interrupting ratings (AIR):

Voltage	G	J	K	L
240 Vac	65 kA	100 kA	65 kA	125 kA
480 Vac	35 kA	65 kA	50 kA	100 kA
600 Vac	18 kA	25 kA	50 kA	25 kA

P-Frame Termination Options

F = No Lugs (Includes terminal nut kit on both ends)
 L = Lugs both ends
 M = Lugs I/ON end, terminal nut kit O/OFF end
 P = Lugs O/OFF end, terminal nut kit I/ON end
 D = Drawout
 A = I-Line

For factory-installed termination, place termination letter in the third block of the circuit breaker catalog number.

P|G|L|3|6|0|4|0|U|4|1|A
 └ Termination Letter

PowerPact P-Frame Codes/Standards

P-frame electronic trip circuit breakers and switches are manufactured and tested in accordance with the following standards:

Standards

P-Frame Circuit Breakers	P-Frame Switches
UL 489 ¹ IEC Standard 60947-2 CSA C22.2 No 5 Federal Specification W-C-375B/GEN NEMA AB1 NMX J-266 UTE, VDE, BS, CEI, UNE, CCC	UL 489 ² IEC Standard 60947-3 CSA C22.2 No 5 Federal Specification W-C-375B/GEN NEMA AB1 NMX J-266 UTE, VDE, BS, CEI, UNE

Circuit breakers should be applied according to guidelines detailed in the NEC and other local wiring codes.

1. PowerPact P-frame circuit breaker is in UL File E63335.
 2. PowerPact P-frame switch is in UL File E103740.

PowerPact P-Frame Interrupting Ratings

Interrupting Ratings

Mounting	Circuit Breaker	Ampere Rating (A)		Interrupting Ratings						
		Basic Electronic Trip Units	Micrologic™ Trip Units	UL/CSA/NMX			IEC 60947-2			
				240 Vac	480 Vac	600 Vac	240 Vac		380/415 Vac	
				Icu	Ics	Icu	Ics	Icu	Ics	
Individually-Mounted	PG	600, 800, 1000, 1200	250, 400, 600, 800, 1000, 1200	65 kA	35 kA	18 kA	50 kA	25 kA	35 kA	20 kA
	PJ			100 kA	65 kA	25 kA	65 kA	35 kA	50 kA	25 kA
	PK			65 kA	50 kA	50 kA	50 kA	25 kA	50 kA	25 kA
	PL			125 kA	100 kA	25 kA ³	125 kA	65 kA	85 kA	45 kA
I-Line™	PG	600, 800, 1000, 1200	250, 400, 600, 800, 1000, 1200	65 kA	35 kA	18 kA	50 kA	25 kA	35 kA	20 kA
	PJ			100 kA	65 kA	25 kA	65 kA	35 kA	50 kA	25 kA
	PK			65 kA	50 kA	50 kA	50 kA	25 kA	50 kA	25 kA
	PL			125 kA	100 kA	25 kA ³	125 kA	65 kA	85 kA	45 kA

PowerPact P-Frame Continuous Current Rating

All circuit breakers marked as 100% rated can be continuously loaded to 100% of their rating.

Because of additional heat generated when applying circuit breakers at 100% of continuous current rating, the use of specially-designed enclosures and 90°C (194°F) wire is required. The 90°C (194°F) wire must be sized according to the ampacity of the 75°C (167°F) wire column in the NEC. Minimum enclosure size and ventilation specifications are indicated on the circuit breaker and in *PowerPact P-Frame Enclosure Sizes*, page 6.

Circuit breakers with 100% rating can also be used in applications requiring only 80% continuous loading.

PowerPact P-Frame Automatic Molded Case Switches

Automatic molded case switches are available in individually-mounted and I-Line constructions from 600–1200 A. Automatic switches are similar in construction to electronic trip circuit breakers except that long-time tripping is not present. The switches open instantaneously at a non-adjustable magnetic trip point calibrated to protect only the molded case switch itself. They must be used in conjunction with a circuit breaker or fuse of equivalent rating.

Automatic Switch Information

Circuit Breaker	Ampere Rating	Voltage Rating	Catalog Number	Withstand Rating			Trip Point (±10%)
				240 Vac	480 Vac	600 Vac	
PJ 2P ⁴ , 3P	600	600 Vac	<i>PJL36000S60</i>	100 kA	65 kA	25 kA	10 kA
	800	600 Vac	<i>PJL36000S80</i>	100 kA	65 kA	25 kA	10 kA
	1000	600 Vac	<i>PJL36000S10</i>	100 kA	65 kA	25 kA	10 kA
	1200	600 Vac	<i>PJL36000S12</i>	100 kA	65 kA	25 kA	10 kA
PK 2P, 3P, 4P ⁵	600	600 Vac	<i>PKL36000S60</i>	65 kA	50 kA	50 kA	24 kA
	800	600 Vac	<i>PKL36000S80</i>	65 kA	50 kA	50 kA	24 kA
	1000	600 Vac	<i>PKL36000S10</i>	65 kA	50 kA	50 kA	24 kA
	1200	600 Vac	<i>PKL36000S12</i>	65 kA	50 kA	50 kA	24 kA
PL 2P, 3P	600	480 Vac	<i>PLL34000S60</i>	125 kA	100 kA	—	10 kA
	800	480 Vac	<i>PLL34000S80</i>	125 kA	100 kA	—	10 kA
	1000	480 Vac	<i>PLL34000S10</i>	125 kA	100 kA	—	10 kA
	1200	480 Vac	<i>PLL34000S12</i>	125 kA	100 kA	—	10 kA

4. For 2P, replace the leading 3 in the catalog number following the prefix with a 2 (*PJL36000S60* becomes *PJL26000S60*). Add the suffix 2 for AC phasing (standard offer), or use 5 for CA phasing (option).

5. For 4P, replace the leading 3 in the catalog number following the prefix with a 4 (*PKL36000S60* becomes *PKL46000S60*).

PowerPact P-Frame Motor Circuit Protectors

Motor circuit protectors are similar in construction to thermal-magnetic circuit breakers, but have only instantaneous trip functions provided by the ET1.0M trip unit. These motor circuit protectors comply with NEC requirements for providing short-circuit protection when installed as part of a listed combination controller having motor overload protection. Interrupting ratings are determined by testing the motor circuit protector in combination with a contactor and overload relay.

Motor circuit protectors are available in PJ and PL individually-mounted and I-Line™ construction. According to the NEC, the instantaneous trip of the motor circuit protector may be set to a maximum of 8 to 17 times motor Full Load Amps (FLA), but a setting as close as possible to inrush current (without nuisance tripping) results in the best protection. The instantaneous trip pickup level is adjustable within the ranges shown below.

Motor Circuit Protector Trip Range

Ampere Rating	Adjustable Trip Range	Catalog Number	
		J-Interrupting—600 Vac	L-Interrupting—480 Vac
600 A	1200–10,000 A	<i>PJL36060M68</i>	<i>PLL34060M68</i>
800 A	1200–10,000 A	<i>PJL36080M68</i>	<i>PLL34080M68</i>
1000 A	1500–10,000 A	<i>PJL36100M69</i>	<i>PLL34100M69</i>
1200 A	1800–10,000 A	<i>PJL36120M70</i>	<i>PLL34120M70</i>

NOTE: Continuous currents larger than the ampere rating can damage the motor circuit protector.

PowerPact P-Frame Electrically-Operated Circuit Breakers

Electrically-operated P-frame circuit breakers are available in I-Line and unit-mount construction up to 1200 A and are denoted in the catalog number by an “M” suffix. These come equipped with a two-step stored energy mechanism and come standard with a motor assembly. These are available factory-installed only.

Motor assemblies provide on and off control from remote locations. The assemblies contain a spring-charging motor (MCH), a shunt trip (MX) and a shunt close (XF) and are available in standard or communicating versions. An SDE overcurrent trip switch is also included for trip indication. When remote indication of the circuit breaker status is required, use of a circuit breaker with an OF auxiliary switch for on-off indication.

Motors Assembly Voltage Ratings (Vn)

Voltage Type	Voltage Ratings (Vn)
Vac 50/60 Hz	48, 100–130, 220–240, 380–415
Vdc	24–30, 48–60, 110–130, 200–250

PowerPact P-Frame Application Information

PowerPact P-Frame Voltage, Frequency and Withstand Ratings

The voltage rating is the highest voltage for the electrical system on which the circuit breaker can be applied. The frequency rating indicates the system frequency for which the circuit breaker is intended. The withstand rating is used to improve system coordination by maximizing the current level at which the circuit breaker trips with no intentional delay. The withstand rating is the level of RMS symmetrical current that a circuit breaker can carry in a closed position for a stated period of time.

Voltage, Frequency and Withstand Ratings

Circuit Breaker	Voltage Rating	Frequency Rating	Withstand Rating at 480 Vac ⁶
PG, PK	600 Vac	50/60 Hz (UL and IEC)	25 kA (0.5 sec)
PJ	600 Vac	50/60 Hz (UL and IEC)	10 kA (0.5 sec)
PL	480 Vac	50/60 Hz (UL and IEC)	10 kA (0.5 sec)

PowerPact P-Frame Enclosure Sizes

All type ET electronic trip UL/IEC M-frame, P-frame and R-frame circuit breakers are available as standard rated circuit breakers. Micrologic electronic trip UL/IEC circuit breakers are also available in 100% rated constructions. Because the additional heat generated when applying circuit breakers at 100% of continuous current rating, the use of specially designed enclosures and 90°C (194°F) rated wire sized per the 75°C (167°F) NEC chart is required.

Circuit breakers with 100% rating can also be used in applications requiring only 80% continuous loading.

Minimum Enclosure Sizes for Fixed-Mounted Circuit Breakers

Circuit Breaker Rating	Enclosure Dimensions (h x w x d)		Ventilation Area	
	3P Circuit Breaker	4P Circuit Breaker	Top	Bottom
P-Frame, ≤ 800 A, 100% Rated P-Frame, ≤ 1200 A, Standard Rated	51.9 x 20.25 x 7.75 in. (1318.3 x 514.4 x 196.9 mm)	51.9 x 23.01 x 7.75 in. (1318.3 x 584.4 x 196.9 mm)	—	—
P-Frame, ≤ 1200 A, 100% Rated	62.25 x 23 x 14.75 in. (1581.2 x 584.2 x 374.7 mm)	62.25 x 25.76 x 14.75 in. (1581.2 x 654.2 x 374.7 mm)	16.5 in. 10,645 mm	16.5 in. 10,645 mm

6. A system coordination study should be done for optimum circuit breaker coordination.

PowerPact P-Frame Operation Ratings

Temperature Re-Rating Values

To meet the requirements of the UL489 Standard, molded case circuit breakers are designed, built and calibrated for use on 50/60 Hz ac systems in a 40°C (104°F) ambient environment. Electronic trip circuit breakers, however, are designed to react only to the magnitude of the current flowing through the circuit breaker and are inherently ambient insensitive. Both UL/IEC and IEC-only circuit breakers may be operated at temperatures between -25°C and +70°C (-13°F and 158°F). For temperatures other than 40°C (104°F), the circuit breakers must be re-rated as shown.

Temperature Re-Rating Values

Maximum Ambient Temperature												
°F	158	140	122	104	86	77	68	50	32	14	-4	-13
°C	70	60	50	40	30	25	20	10	0	-10	-3	-25
Current	0.75	0.83	0.92	1	1.07	1.11	1.14	1.21	1.27	1.33	1.39	1.42

Altitude Derating Values

Circuit breakers are suitable for use at altitudes up to 13,100 ft. (4000 m). For altitudes higher than 6560 ft. (2000 m), circuit breakers must be derated as shown.

Altitude Derating Values Per ANSI C37.20.1

Altitude	≤ 6,600 ft. (≤ 2,000 m)	8,500 ft. (2,600 m)	13,000 ft. (3,900 m)
Voltage	1	0.95	0.8
Current	1	0.99	0.96

PowerPact P-Frame Trip Unit Details

Micrologic Electronic Trip Systems

The P-frame electronic trip circuit breakers can be equipped with the optional Micrologic trip systems listed below:

Micrologic Trip Systems

Model	(LS0) Long-time + Short-time + Zero delay (IEC Rated Only)	(LI) Long-time + Instantaneous Protection (UL Listed, IEC Rated)	(LSI) Long-time + Short-time + Instantaneous Protection (UL Listed, IEC Rated)	(LSIG) Long-time + Short-time + Instantaneous Protection + Equipment Ground-Fault Protection (UL Listed, IEC Rated)
Micrologic Basic Trip Unit	2	3	5	—
Micrologic A Trip Unit	2.0A	3.0A	5.0A	6.0A
Micrologic P Trip Unit	—	—	5.0P	6.0P
Micrologic H Trip Unit	—	—	5.0H	6.0H

Micrologic™ Trip Unit Features

Feature	Micrologic Trip Unit (X = Standard Feature O = Available Option)										
	Standard			Ammeter				Power		Harmonics	
	2	3	5	2.0A	3.0A	5.0A	6.0A	5.0P	6.0P	5.0H	6.0H
Field-Installable	X	X	X	X	X	X	X	X	X	X	X
LI		X			X						
LS0	X			X							
LSI			X			X		X		X	
LSIG/Ground-Fault Trip ⁷							X		X		X
Ground-Fault Alarm/No Trip ^{7,8}								X		X	
Ground-Fault Alarm and Trip ^{7,8}									X		X
Adjustable Rating Plugs	X	X	X	X	X	X	X	X	X	X	X
True RMS Sensing	X	X	X	X	X	X	X	X	X	X	X
UL Listed		X	X		X	X	X	X	X	X	X
Thermal Imaging	X	X	X	X	X	X	X	X	X	X	X
Phase-Loading Bar Graph				X	X	X	X	X	X	X	X
LED for Long-Time Pick-Up	X	X	X	X	X	X	X	X	X	X	X
LED for Trip Indication				X	X	X	X	X	X	X	X
Digital Ammeter				X	X	X	X	X	X	X	X
Zone-Selective Interlocking ⁹				X		X	X	X	X	X	X
Communications				O	O	O	O	X	X	X	X
LCD Dot Matrix Display								X	X	X	X
Advanced User Interface								X	X	X	X
Protective Relay Functions								X	X	X	X
Neutral Protection ¹								X	X	X	X
Contact Wear Indication								X	X	X	X
Incremental Fine Tuning of Settings								X	X	X	X
Selectable Long-Time Delay Bands								X	X	X	X
Power Measurement								X	X	X	X
Power Quality Measurements										X	X
Waveform Capture										X	X

7. 3Ø, 4W circuits require either a neutral current transformer or a 4-pole circuit breaker.

8. Requires M6C Programmable Contact Module.

9. Not available for 2.0A trip units as upstream devices.

Micrologic Control Wiring

Control wiring for unit-mount and I-Line construction is connected to terminals located under the circuit breaker accessory cover. Control wiring for drawout construction is connected to terminals located on the cradle.

Accessory Control Wiring Diagrams for Manually-Operated Circuit Breakers

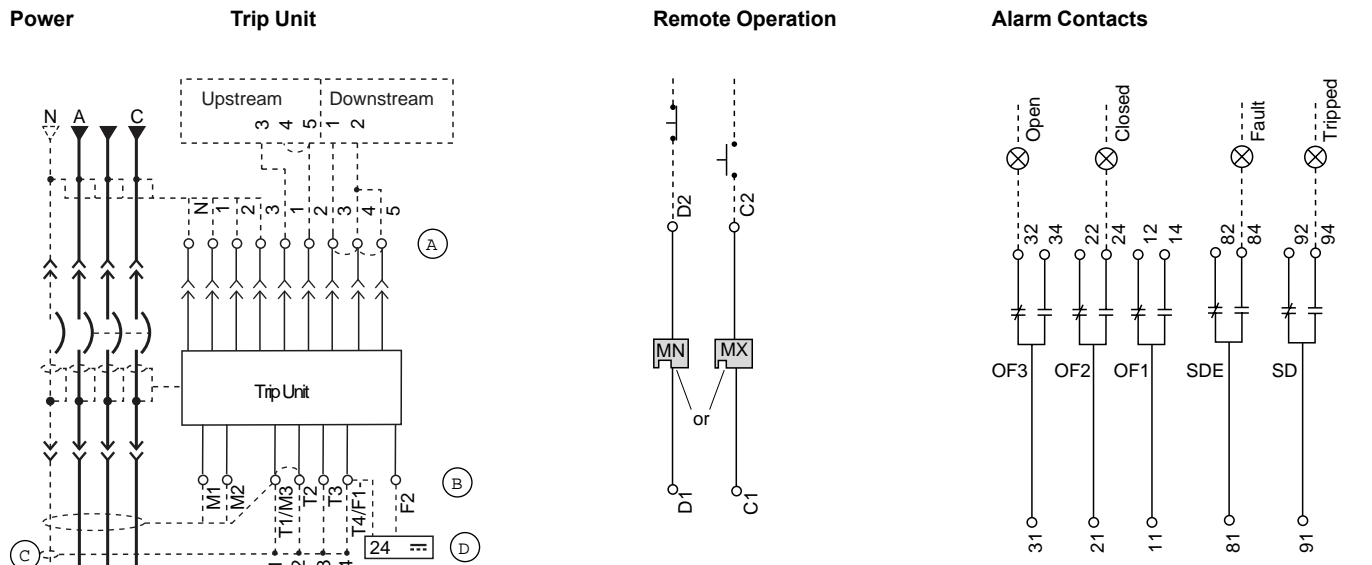

NOTE: All diagrams show circuit breaker in open position.

- A—Do not remove factory-installed jumpers between Z3, Z4 and Z5 unless ZSI is connected.
- B—Do not remove factory-installed jumper between T1 and T2 unless neutral CT is connected. Do not install jumper between T3 and T4.
- C—For proper wiring of neutral CT, refer to Instruction Bulletin 48041-082-01 shipped with it.
- D—24 Vdc power supply for trip unit must be separate and isolated from 24 Vdc power supply for communication modules.

Accessory Control Wiring for Manually-Operated P-Frame Circuit Breaker

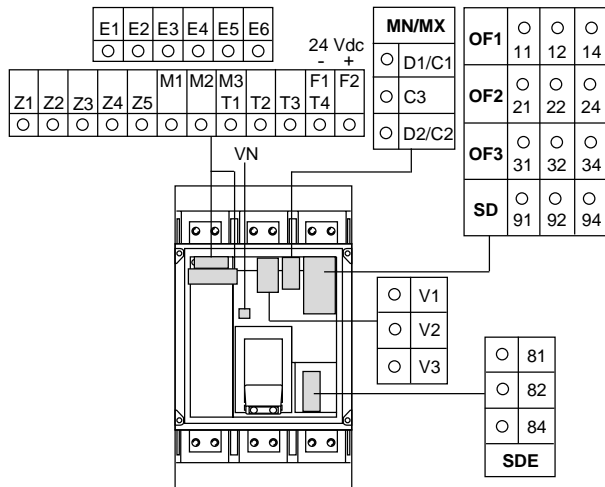

Trip Unit Type					Connector	Description
Basic	A	P	H			
—	•	•	•	Com: E1-E6	Circuit breaker communication module E1 = +24 Vdc E2 = Common E3 = A/Tx- D0 E4 = B/Tx+ D1 E5 = A/Rx- D0 E6 = B/Rx+ D1	
—	•	•	•	Z	Zone-selective interlocking (ZSI) Z1 = ZSI OUT signal Z2 = ZSI OUT Z3 = ZSI IN signal Z4 = ZSI IN short-time delay Z5 = ZSI IN ground fault	
—	•	•	•	T	External neutral sensor	
—	•	•	•	F	24 Vdc external power supply	
—	—	•	•	Vn	External neutral voltage takeoff	
—	—	•	•	V1, V2, V3	External phase voltage takeoff	
—	—	•	•	M6C ¹⁰ : Q1, Q2, Q3	6 programmable contacts 24 Vdc external power supply required	

Connector	Recommended Wire Size
V1, V2, V3, Vn	22–16 AWG (0.3–1.5 mm ²)
E1–E2	22 AWG (0.3 mm ²) MIN shielded pair cable or twisted pair copper wires
T	22 AWG (0.3 mm ²) stranded shielded cable
M	Refer to MDGF instructions
E3–E6, Q1, Q2, Q3	22 AWG (0.3 mm ²) shielded twisted pairs with drain (Belden 8723 or equal) ³
OF, SD, SDE	18–16 AWG (0.8–1.5 mm ²)
MN, MX	18–14 AWG (0.8–2.5 mm ²)
F	Size per aux 24 Vdc power supply
Z1–Z5	22–18 AWG (0.3–0.8 mm ²)

Function	Connector	Description
Auxiliary Contacts	OF	Open/Closed circuit breaker or switch position contacts
	SD	Bell alarm
	SDE	Electrical fault alarm contact
Remote Operation	MN	Undervoltage trip device
	MX	Shunt trip

10. Optional M6C programmable contacts are supplied with flying leads.

Accessory Control Wiring Diagrams for P-Frame Circuit Breakers

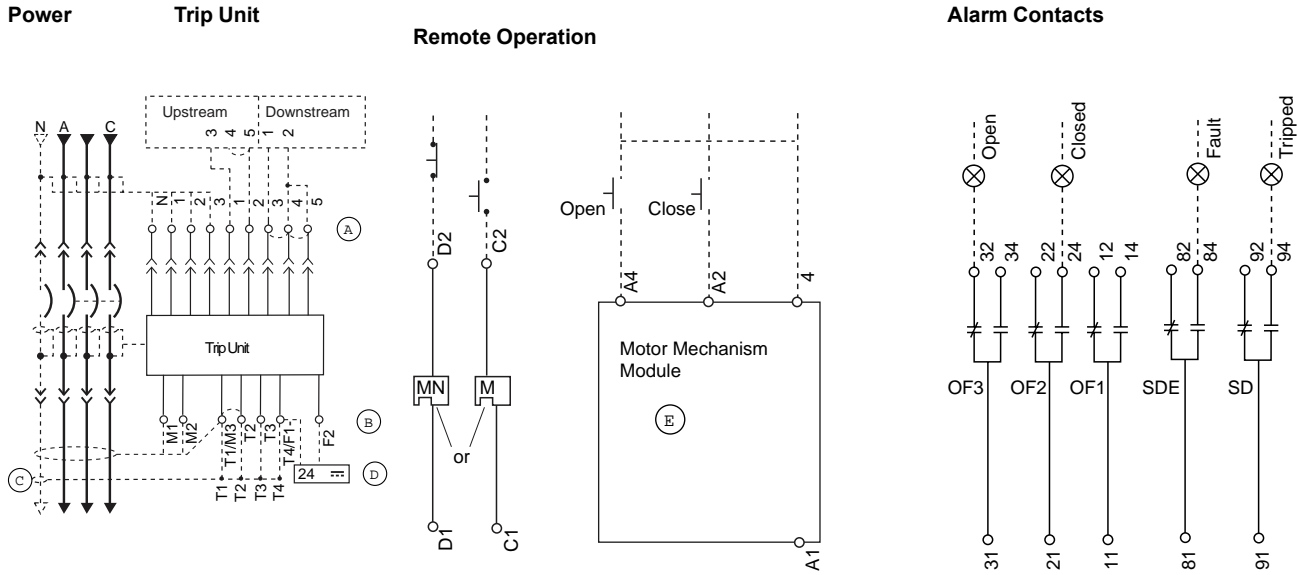

NOTE: All diagrams show circuit breaker in open position.

- A—Do not remove factory-installed jumpers between Z3, Z4 and Z5 unless ZS1 is connected.
- B—Do not remove factory-installed jumper between T1 and T2 unless neutral CT is connected. Do not install jumper between T3 and T4.
- C—For proper wiring of neutral CT, refer to Instruction Bulletin 48041-082-01 shipped with it.
- D—24 Vdc power supply for trip unit must be separate and isolated from 24 Vdc power supply for communication modules.
- E—Motor mechanism includes opening and closing coils.

Control Wiring for Electrically-Operated P-Frame Circuit Breaker

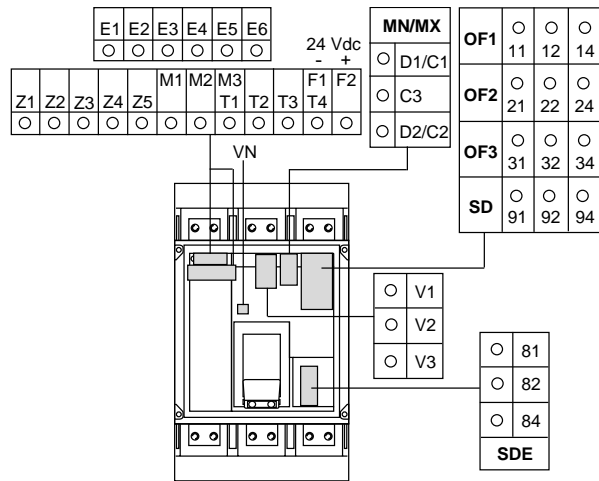

Trip Unit Type						Description
Basic	A	P	H	Connector		
—	•	•	•	Com: E1-E6	Circuit breaker communication module E1 = +24 Vdc E2 = Common E3 = A/Tx- D0 E4 = B/Tx+ D1 E5 = A/Rx- D0 E6 = B/Rx+ D1	
—	•	•	•	Z	Zone-selective interlocking (ZSI) Z1 = ZSI OUT signal Z2 = ZSI OUT Z3 = ZSI IN signal Z4 = ZSI IN short-time delay Z5 = ZSI IN ground fault	
—	•	•	•	T	External neutral sensor	
—	•	•	•	F	24 Vdc external power supply	
—	—	•	•	Vn ¹¹	External neutral voltage takeoff	
—	—	•	•	V1, V2, V3	External phase voltage takeoff	
—	—	•	•	M6C: Q1, Q2, Q3	6 programmable contacts 24 Vdc external power supply required	
Function		Connector		Description		
Auxiliary Contacts		OF		Open/Closed circuit breaker or switch position contacts		
		SDE		Electrical fault alarm contact		
Remote Operation		MN		Undervoltage trip device		
		MX		Shunt trip		
Motor Mech Module		A4		Electrical opening		
		A2		Electrical closing		
		B4, A1		Power supply for control devices and gear motor		

Connector	Recommended Wire Size
V1, V2, V3, Vn	22–16 AWG (0.3–1.5 mm ²)
E1–E2	22 AWG (0.3 mm ²) MIN shielded pair cable or twisted pair copper wires
T	22 AWG (0.3 mm ²) stranded shielded cable
M	Refer to MDGF instructions
E3–E6, Q1, Q2, Q3	22 AWG (0.3 mm ²) shielded twisted pairs with drain (Belden 8723 or equal) ³
OF, SD, SDE	18–16 AWG (0.8–1.5 mm ²)
MN, MX	18–14 AWG (0.8–2.5 mm ²)
F	Size per aux 24 Vdc power supply
Z1–Z5	22–18 AWG (0.3–0.8 mm ²)

11. Optional M6C and external voltage takeoff are supplied with flying leads.

PowerPact P-Frame Trip Curves

Trip curves are available on the Schneider Electric website:

http://www.digestplus-us.schneider-electric.com/additional_product_infos

Time-Current Curves

Circuit Breaker

PowerPact P (100-1200 A)



Subcategory

G (Ground Fault)



Results

Micrologic 6.0 A/P/H, 400A<In<1200A, Adjustable Ground-fault Pickup/Delay, Ground-fault I²t OFF/ON (613-2)

Micrologic 6.0 A/P/H, In<400A, Adjustable Ground-fault Delay, Ground-fault I²t OFF/ON (613-1)

Micrologic 6.0 A/P/H, In>1200, Adj.Ground-fault Delay Ground-fault I²t OFF and ON (613-3)

PowerPact P-Frame Common Accessories

PowerPact P-frame circuit breakers can be used with a variety of internal and external accessories to increase application versatility and meet the demands of modern electrical distribution systems.

Circuit breaker internal accessories are available either factory installed or field installable. They can be installed in accessory compartments behind the circuit breaker accessory cover.

Factory-Installed Accessories

Factory-installed accessories are internally mounted by the factory. Accessories only available factory installed cannot be removed or repaired in the field. Order factory-installed accessories by adding the correct two-letter suffix to the standard circuit breaker catalog number. To build a catalog number, refer to the product selector or contact a field office.

Field-Installable Accessories

Field-installable accessories can be installed or replaced in the field without affecting the circuit breaker ratings. Field-installable accessories are shipped separately from the circuit breakers. Install and wire field-installable accessories according to the instructions supplied with the circuit breaker and particular accessory. Order field-installable accessories by the catalog number found in the *Schneider Electric Digest*.

PowerPact P-Frame Control Wiring

Control wiring is connected to terminals located under the circuit breaker accessory cover.

NOTE: All diagrams show circuit breaker in open position.

Accessory Control Wiring Diagrams

Function	Connector	Description	Remote Operation	Alarm Contacts
Auxiliary Contacts	OF	Open/Closed Circuit Breaker Position Contacts		
	SD	Bell Alarm		
Remote Operation	MN	Undervoltage Trip Device		
	MX	Shunt Trip		

Shunt Trip and Shunt Close Characteristics

Characteristics		MX1	XF	Min	Max	
Voltage Ratings (Vn)	Vac 50/60 Hz	24 Vac		17 Vac	26 Vac	
		48 Vac		34 Vac	52 Vac	
		120 Vac		60 Vac	132 Vac	
		240 Vac		168 Vac	264 Vac	
		277 Vac		194 Vac	304 Vac	
		380 Vac		266 Vac	418 Vac	
		480 Vac		336 Vac	528 Vac	
	Vdc	12 Vdc		8 Vdc	13 Vdc	
		24 Vdc		17 Vdc	26 Vdc	
		48 Vdc		34 Vdc	52 Vdc	
		125 Vdc		88 Vdc	137 Vdc	
		250 Vdc		175 Vdc	275 Vdc	
	Operating Threshold		0.7 to 1.1 Vn	0.85 to 1.1 Vn		
	Power Consumption (VA or W)	Steady-State/Inrush	4.5/200			
Circuit Breaker Response Time at Vn		50 ms ±10	70 ms ±10 (NW ≤ 4000 A) 80 ms ±10 (NW > 4000 A) 55 ms (NT)			

Undervoltage Trip Characteristics

Characteristics		MN	
Voltage Ratings (Vn)	Vac 50/60 Hz	24 Vac	
		48 Vac	
		120 Vac	
		240 Vac	
		277 Vac	
		380 Vac	
		480 Vac	
	Vdc	12 Vdc	
		24 Vdc	
		48 Vdc	
		125 Vdc	
		250 Vdc	
	Power Consumption (VA or W)	Constant/Inrush	4.5/200
	Operating Threshold	Opening	0.35 to 0.70 Vn
Closing		0.35 Vn	
Circuit Breaker Response Time at Vn		90 ms ±5	

PowerPact P-Frame Accessories

Accessory (Y = Yes , N = No, N/A = Not Available)	Manually-Operated Circuit Breakers		Electrically Operated Circuit Breakers	
	Field Installable	Factory Installed	Field Installable	Factory Installed
Shunt Trip (MX)	Y	Y	Y	Y
Undervoltage Trip (MN)	Y	Y	Y	Y
Adjustable Time Delay Module for Undervoltage Trip	Y	N	Y	N
Auxiliary Switch (OF)	Y	Y	Y	Y
Alarm Switch (SD)	Y	Y	N/A	N/A
Overcurrent Trip Switch (SDE)	Y	Y	Y	Y
Spring-Charging Motor	N/A	N/A	Y	Y
Trip Unit Replacement Covers	Y	N	Y	N
Neutral Current Transformer	Y	N	Y	N
Ground-Fault Interface Module	Y	Y	Y	Y
External Sensor for SGR or MDGF Protection	Y	Y	Y	Y
Sensor Plugs	Y	Y	Y	Y
Rating Plugs	Y	Y	Y	Y
M2C and M6C Programmable Contacts	Y	Y	Y	Y
Circuit Breaker Communication Module	Y	Y	Y	Y
Restraint Interface Module	Y	N	Y	N
External Power Supply Module	Y	Y	Y	Y
External Battery Backup Module	Y	Y	Y	Y
Hand-Held Test Kit	Y	Y	Y	Y
Full-Function Test Kit	Y	Y	Y	Y
Mechanical Lug	Y	Y	Y	Y
Compression Lug	Y	Y	Y	Y
Terminal Pad	Y	Y	Y	Y
I-Line Jaws	N	Y	N	Y
Power Distribution Connectors	Y	Y	Y	Y
Control Wire Terminations	Y	Y	Y	Y
Phase Barriers	Y	N	Y	N
Electric Joint Compound	Y	N	Y	N
Door-Mounted Operating Mechanism	Y	Y	Y	Y
Rotary Handle	N	Y	N/A	N/A
Replacement Handles	Y	Y	Y	Y
Long Handle Extension	Y	Y	N/A	N/A
Accessory Cover Door Escutcheons	Y	N	Y	N
Padlock Attachment	Y	Y	Y	Y
Keylock	N	Y	N	Y
Keylock Provision	N	Y	N	Y
Sub-Feed Lugs	Y	Y	Y	Y

PowerPact P-Frame External Accessories

Phase Barriers

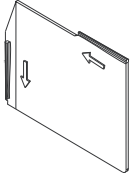

Phase Barriers

Phase barriers are available for unit-mount circuit breakers with bus connections or with lugs ≤ 800 A.

Phase Barriers

Cat. No.	Qty Per Kit
S33646	3

Electric Joint Compound

I-Line circuit breakers, I-Line busway plug-on units and I-Line panelboards and switchboards are supplied with factory-applied joint compound on the plug-on connectors. The compound is especially formulated for I-Line connections and contributes to the overall performance of the connection.

If the joint compound is removed, it must be reapplied. A two-ounce container of the compound (Cat. No. *PJC7201*) is available.

PowerPact P-Frame Handle Extension

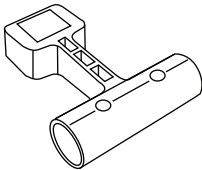

Handle extensions are available for P-frame circuit breakers. Order catalog number 33195.

PowerPact P-Frame Replacement Handles

Replacement toggle handle extensions, including an optional longer handle extension, are available for P-frame circuit breakers.

Replacement Handles for PowerPact P-Frame Circuit Breakers

Description	Field-Installed Cat. No.
Standard Short	S46998
Long	S46996

PowerPact P-Frame Door Mounted Operating Mechanisms

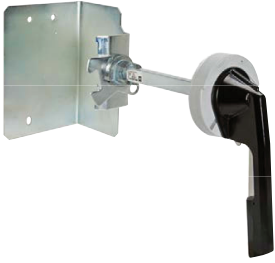

Door-mounted operating mechanisms are available for P-frame circuit breakers. The Type L door-mounted variable-depth operating mechanism feature heavy-duty, all-metal constructions. They can be padlocked in the OFF position when the enclosure door is open. Handle assemblies can be locked OFF with up to three padlocks, which also locks the door closed. Complete kits include a handle assembly, operating mechanism, and shaft assembly, and are rated for NEMA Type 1, 3R and 12 enclosures. A door drilling template is supplied for ease of installation.

Description		Handle Assembly ¹²	Shaft Mounting Depth	Cat. No.
Circuit Breaker Mechanism	Type L	Painted, 8 inch	7.2–11.625 in. (182–295 mm)	LW1
		Painted, 8 inch	7.2–22.25 in. (182–565 mm)	LW4
Handle Assembly ¹³	Type 3, 4	Painted, 8 inch	7.2–11.625 in. (182–295 mm)	LHP48
	Type 3, 4, 4X	Chrome Plated, 8 inch		LCP48
Replacement Parts	Handle Assembly	Painted, 8 inch	—	SLHP8
	Operating Mechanism	—	—	LW7
	Standard Shaft	—	7.2–11.625 in. (182–295 mm)	LS8
	Long Shaft	—	7.2–22.25 in. (182–565 mm)	LS10

PowerPact P-Frame Flexible Cable Mechanisms

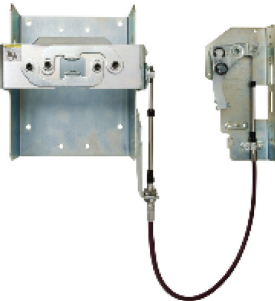

Flexible cable mechanisms are for use with Class 9422 handle operators specially designed for tall, deep enclosures where placement flexibility is required.

Flexible Cable Mechanism	No of Poles	Frame Size	Cable Mechanism	
			Length	Type
9422CSJ30	3	1200 A	48 in.	CMP40
			50 in.	CMP50
			120 in.	CMP10

PowerPact P-Frame Door Escutcheons

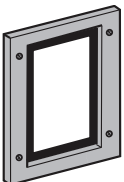

Accessory cover door escutcheons are available for all M-frame circuit breakers.

Door Escutcheons for P-Frame Circuit Breakers

Description	Field-Installed Cat. No.
Accessory Cover	S33718
Toggle Handle	S33717

12. Painted handles are painted flat black, with the base ring silver.

13. Due to gasketing, NEMA 3 and 4 handle assemblies are NOT trip indicating.

PowerPact P-Frame Locking Accessories

Locks and Interlocking

Device	Description		Factory-Installed Cat. No. Suffix	Field-Installed Cat. No.
Handle Padlocking Device	Removable (Lock Off Only)		—	S44936
	Fixed (Lock Off or On)		YP	S32631
	Fixed (Lock Off Only)		YQ	MPRPAF
Interlocking (Not UL listed)	Mechanical for Circuit Breakers with Rotary Handles ¹⁴		—	S33890
Key Locking	Provision Only, Vertical Mount, 1 key interlock including padlock provision, open position only	Kirk	JE1	—
	Provision Only, Vertical Mount, 1 or 2 Locks	Kirk	JA	—
	Provision Only, Horizontal Mount	Kirk	JK	—
	1 Lock	Ronis	JB	—
	Provision and 1 Lock, Vertical Mount	Kirk	JG	—
	Provision and 1 Lock, Horizontal Mount	Kirk	JL	—
		Ronis	JC	—
		Profalux	JF	—
	Provision and 2 Locks Keyed Alike, Vertical Mount	Kirk	JN	—
	Provision and 2 Locks Keyed Alike, Horizontal Mount	Kirk	—	—
	Provision and 2 Locks Keyed Differently, Vertical Mount	Kirk	JP	—
Provision and 2 Locks Keyed Differently, Horizontal Mount	Kirk	—	—	

14. Not available on motor-operated or I-Line circuit breakers.

PowerPact P-Frame Sub-Feed Lugs

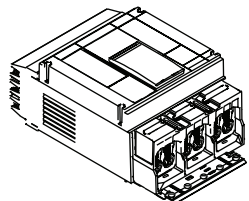
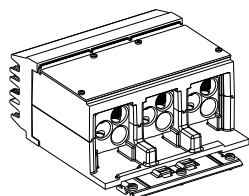

Sub-feed lug kits are UL Listed for use on Listed equipment. They have plug-on jaw construction and plug on to the I-Line bus stack in the same manner as branch circuit breakers. Lugs on these devices accommodate the same wire sizes as the equivalent ampere rated circuit breakers.

I-Line Sub-Feed Lug Kit Terminations

Plug-On Lug Kit Cat. No.	Poles	Mounting Height	Ampere Rating	Lug		
				Catalog No.	Wire Size	Conductors Per Lug
SL800M5	3		800 A	—	3/0 AWG–500 kcmil (95–240 mm ²)	3
SL1200P5	3		1200 A	—	3/0 AWG–500 kcmil (95–240 mm ²)	4
SL1200P6	3		1200 A	—	350–600 kcmil (185–300 mm ²)	3
SL1200P7	3		1200 A	—	3/0 AWG–750 kcmil (95–400 mm ²)	2
S33931	3	9 in.	1200 A	<i>AL1200P24K</i>	3/0 AWG–500 kcmil (95–240 mm ²)	4
S33930	3	15 in.	1200 A	<i>AL1200R53K</i>	3/0 AWG–600 kcmil (95–300 mm ²)	4