

OPTION 1 – HORIZONTAL MOUNTING

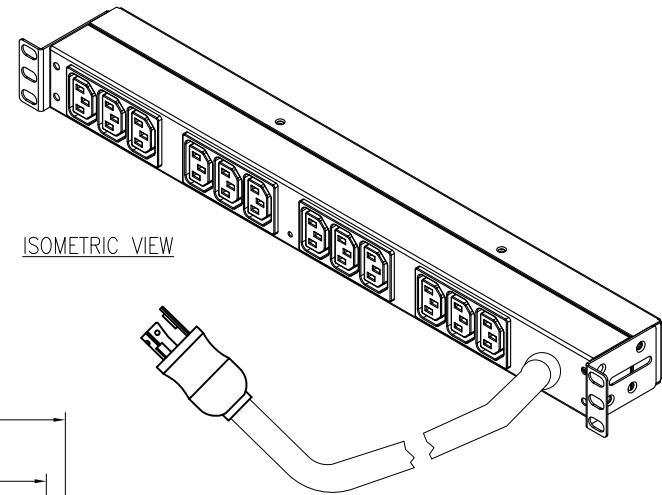

ISOMETRIC VIEW

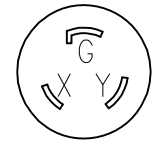
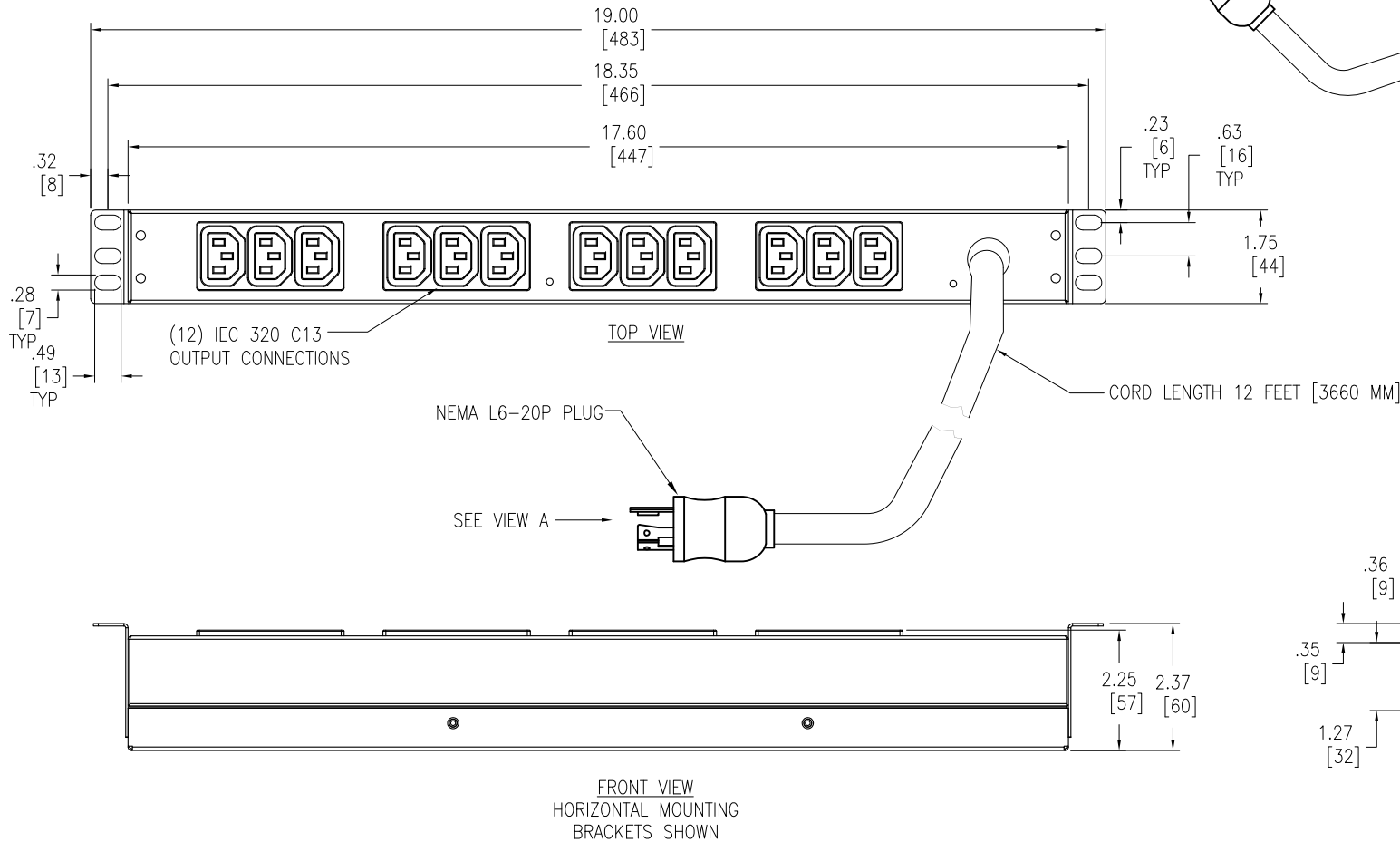

VIEW A
NEMA L6-20P
(ENLARGED)

NOTES:

1. INSTALLATION SHALL COMPLY WITH ALL APPLICABLE NATIONAL, STATE, AND LOCAL CODES
2. PLEASE REFER TO PRODUCT DOCUMENTATION FOR FURTHER INFORMATION.
3. ALL DIMENSIONS ARE IN INCHES [MILLIMETERS].
4. NET WEIGHT IS 5.50 LBS, [2.50 kg].
5. BRACKET KITS TO MOUNT TO SPECIFIC COMPETITORS RACKS ARE AVAILABLE AS OPTIONS.

THIS DRAWING AND SPECIFICATIONS HEREIN ARE THE PROPERTY OF AMERICAN POWER CONVERSION AND SHALL NOT BE COPIED, REPRODUCED OR USED IN WHOLE OR IN PART, AS THE BASIS FOR THE MANUFACTURE OR SALE OF ITEMS WITHOUT WRITTEN PERMISSION FROM APC. THIS DRAWING IS BASED UPON LATEST AVAILABLE INFORMATION AND IS SUBJECT TO CHANGE WITHOUT NOTICE.



TITLE:

RACK, PDU, BASIC, 1U
INPUT: 208V, 16A, NEMA L6-20P
OUTPUT: 120V, (12) IEC 320 C13
MAIN MECHANICAL-HORIZONTAL MOUNTING

PROJECT: SUBMITTAL DRAWINGS SHEET 1 OF 2

DWG NO:

AP9566

REV. 0
DRAWN: B ZAHN 30-DEC-08
ENGINEER: Y JIANG/T HORSTMANN 30-DEC-08
APPROVED: B SHERIDAN 30-DEC-08

THIRD ANGLE PROJECTION

OPTION 2 – VERTICAL MOUNTING

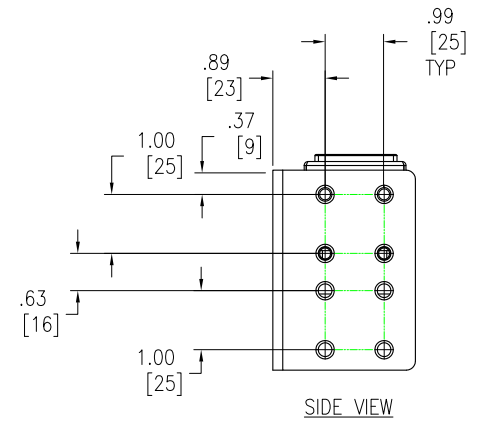
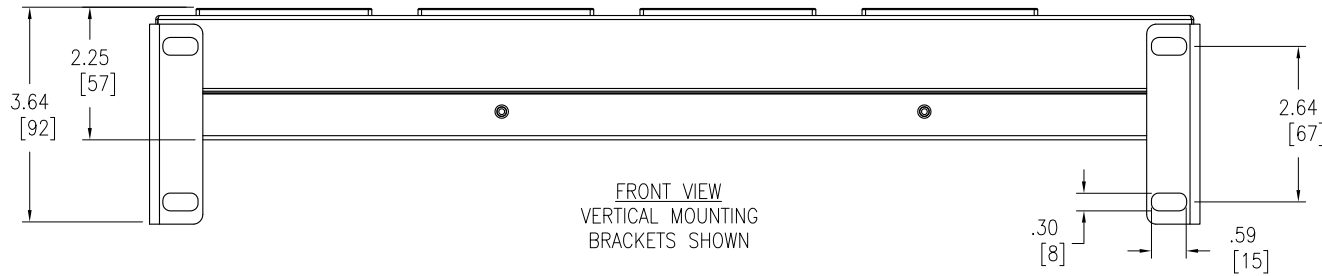
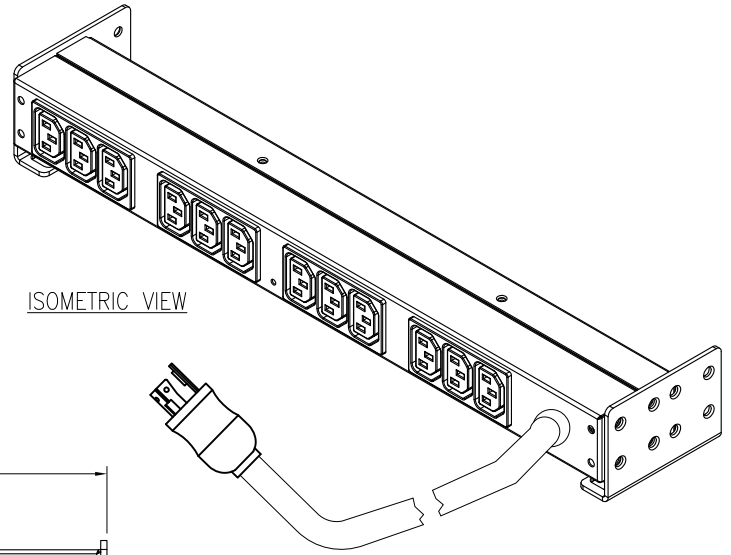
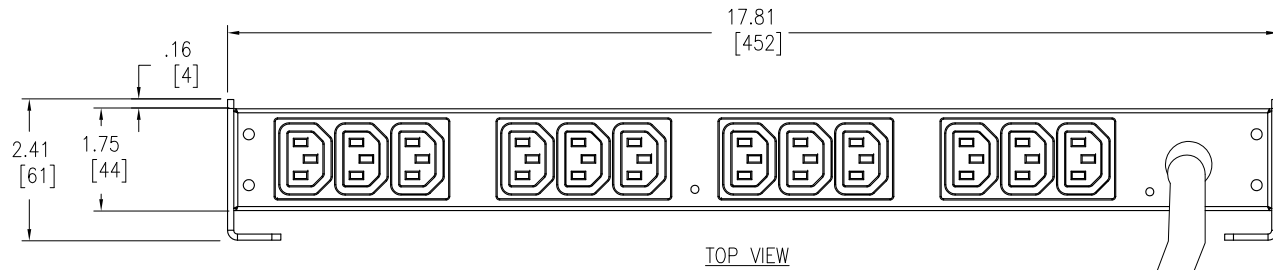

NOTES:

1. INSTALLATION SHALL COMPLY WITH ALL APPLICABLE NATIONAL, STATE, AND LOCAL CODES
2. PLEASE REFER TO PRODUCT DOCUMENTATION FOR FURTHER INFORMATION.
3. ALL DIMENSIONS ARE IN INCHES [MILLIMETERS].
4. NET WEIGHT IS 5.50 LBS, [2.50 kg].
5. BRACKET KITS TO MOUNT TO SPECIFIC COMPETITORS RACKS ARE AVAILABLE AS OPTIONS.

THIS DRAWING AND SPECIFICATIONS HEREIN ARE THE PROPERTY OF AMERICAN POWER CONVERSION AND SHALL NOT BE COPIED, REPRODUCED OR USED IN WHOLE OR IN PART, AS THE BASIS FOR THE MANUFACTURE OR SALE OF ITEMS WITHOUT WRITTEN PERMISSION FROM APC. THIS DRAWING IS BASED UPON LATEST AVAILABLE INFORMATION AND IS SUBJECT TO CHANGE WITHOUT NOTICE.



TITLE:
RACK, PDU, BASIC, 1U
INPUT: 208V, 16A, NEMA L6-20P
OUTPUT: (12) IEC 320 C13
MAIN MECHANICAL-VERTICAL MOUNTING
PROJECT: SUBMITTAL DRAWINGS SHEET 2 OF 2

DWG NO:	AP9566		REV:	0
DRAWN:	B ZAHN	30-DEC-08	PROJECTION	ANGLE
ENGINEER:	Y JIANG/T HORSTMANN	30-DEC-08		
APPROVED:	B SHERIDAN	30-DEC-08		
				N/A