

Panel Thickness E dim. inches (mm)	Number of Gasket
1/16 (1.6)	4
1/8 (3.2)	3
3/16 (4.8)	2
1/4 (6.4)	1

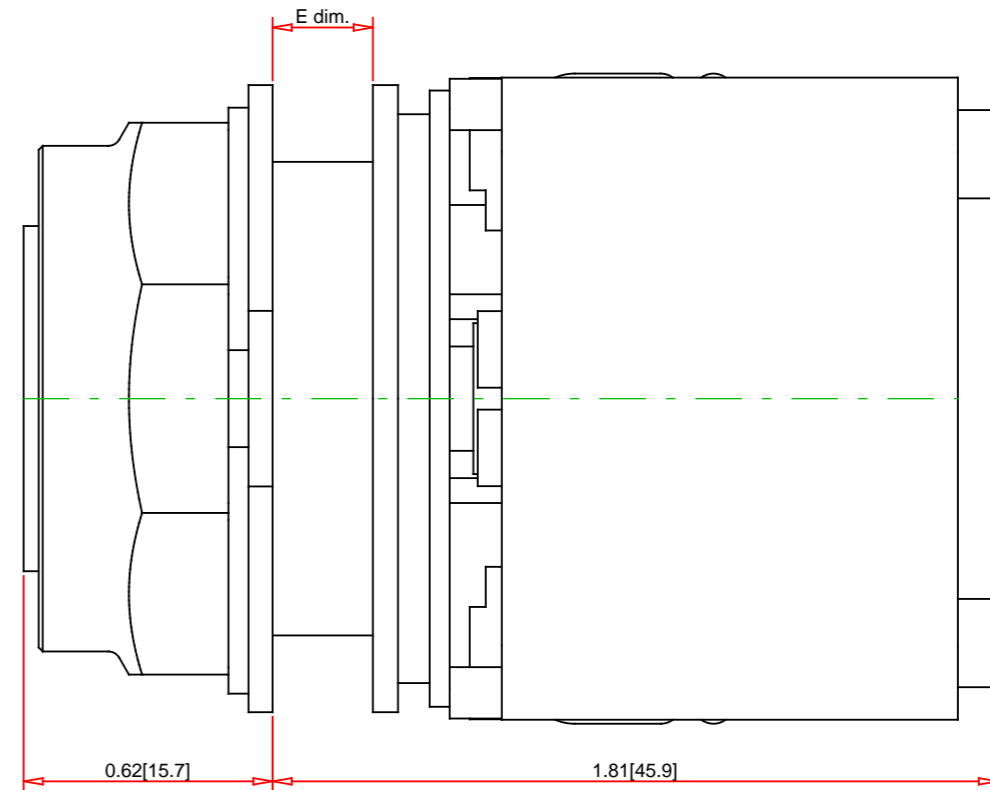
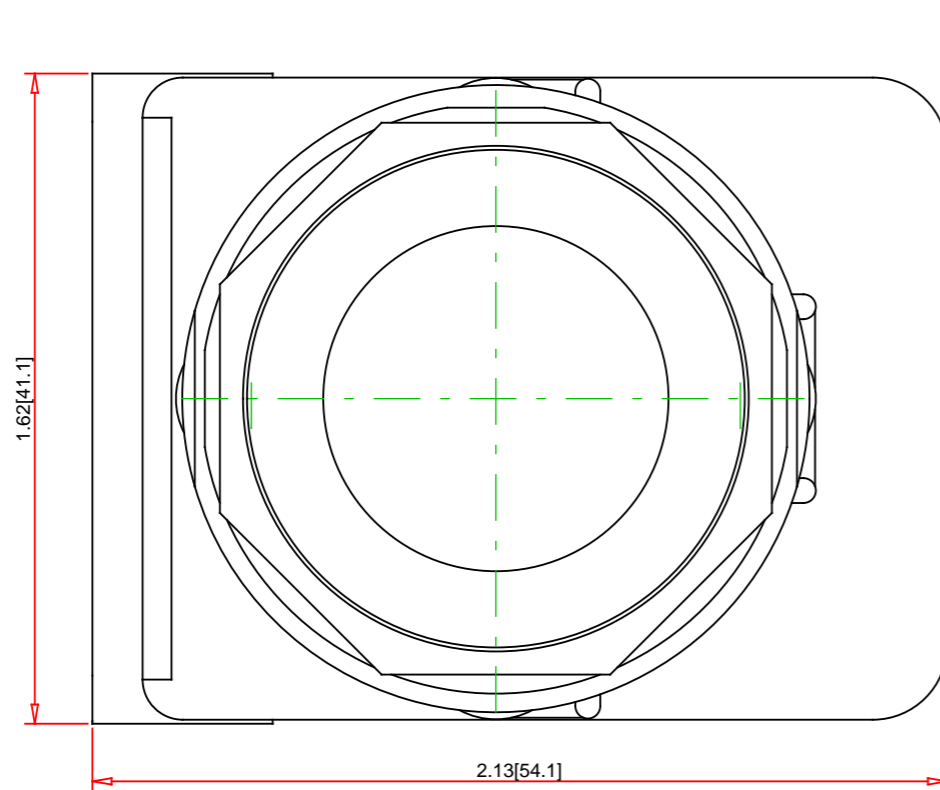

Note:
- Drawings Not To Scale
- Drawings Subject to Change Without Notice
- Dimensions are inches next to [Millimeters]

Part No.:

9001SKP31

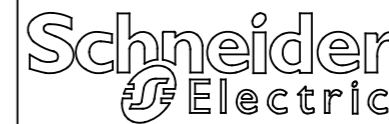

Schneider Electric United States
North American Division
Boston One Campus
800 Federal Street
Andover, MA 01810, USA
Phone: +1 8773425173
Email: CCC@us.schneider-electric.com

Technical Information:

UL File: E78403 CCN NKCR
CSA File: LR24590 Class 3211-03
CE Marked: Yes
RoHS: Yes
NEMA / IP Rating: NEMA 1/2/3/3R/4/4X/6/12/13 Water tight, Dust tight, Oil tight and Corrosion Resistant (Indoor/Outdoor)
Key Number: n/a
Key Removal: n/a
Light Module Supply Voltage: 6V
Light Module Type: Full Voltage
Number of Operators: n/a

Description: 30mm Pilot Light
Ring Nut Material: Black Plastic
Operator Type: Standard
Operator Action: n/a
Guard Type: n/a
Button/Cap Color: n/a
Lens Type: No Lens
Lens Color: No Lens
Knob Type: not applicable
Knob Color: n/a
Number of Positions: n/a

Specification: