

## Installation Guide Back-UPS™ APCRBC160/161/162/163

### APCRBC160, APCRBC161, APCRBC162, APCRBC163

1

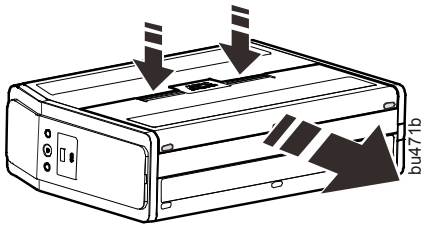

2

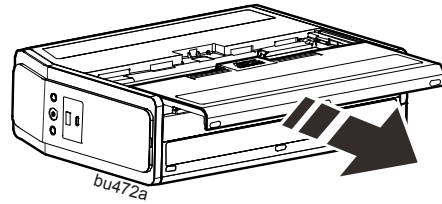

3

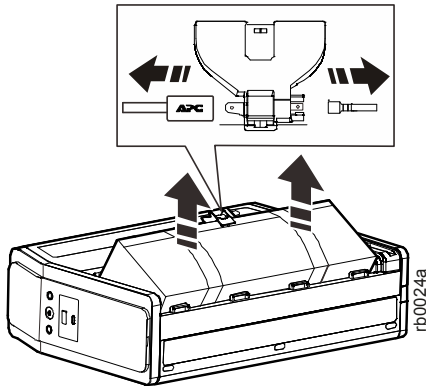

4

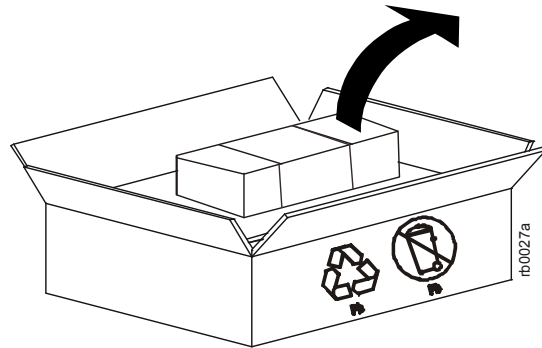

5

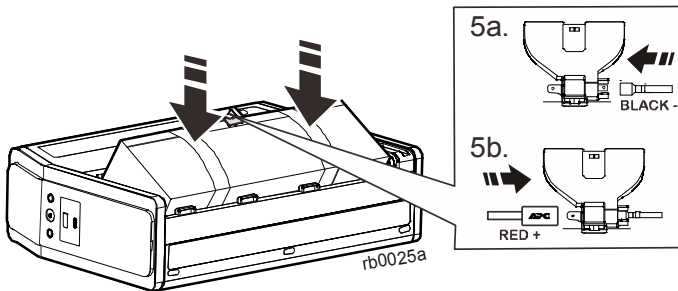

6

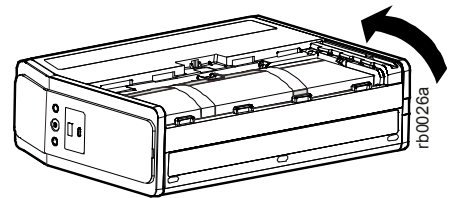

7

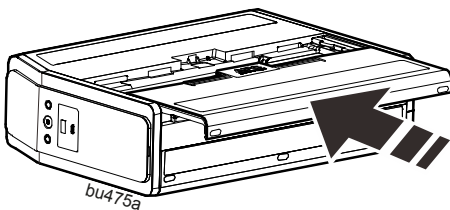

8

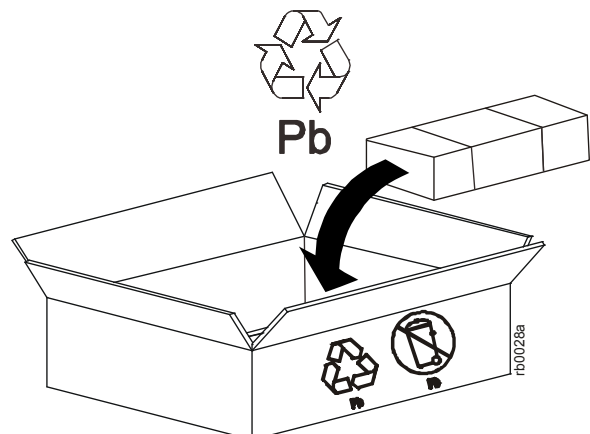

Customer support and warranty information is available at the APC by Schneider Electric Web site, [www.apc.com](http://www.apc.com).

© 2017 APC by Schneider Electric. APC, the APC logo, and Back-UPS are owned by Schneider Electric Industries S.A.S., or their affiliated companies. All other trademarks are property of their respective owners.

EN 990-91086

10/2017