

Osisense™ XML

Electronic Pressure Sensors

Catalog



Selection Guide 4

- Selecting a Pressure Switch 8

OsiSense® XML electronic pressure sensors

- General Overview 10

- Terminology 11

- XMLK pressure transmitters:

- Introduction 14
- Specifications 15
- Selection and Specifications 16
- Accessories and Wiring 20
- Dimensions 21

- XMLG pressure transmitters and pressure/vacuum switches:

- Introduction 22
- Specifications 23
- Selection and Specifications 24
- Accessories and Replacement Parts 32
- Dimensions and Wiring 33

- XMLF pressure sensors:

- Introduction 34
- Specifications 36
- Selection and Specifications 38
- Accessories and Replacement Parts 64
- Dimensions and Wiring 65

- XMLE pressure transmitters and pressure switches:

- Introduction 66
- Specifications 67
- Selection and Specifications 68
- Accessories 76
- Dimensions and Wiring 77

Applications	Type of installation	Control circuits
	Fluids controlled	
	Type of sensor and features	



Fluid characteristics	Air, fresh water, 0 to + 80°C (32.0 to 176.0 °F)	
Sizes	0 to 25 bar (0 to 300 psi)	
Dimensions of case mm (in.)	Width x height x depth	Ø 36 x 79.5 (Ø 1.40 x 3.10)
Type of output	Analog, 4...20 mA or 0...10 V	
Degree of protection	IP 65 conforming to IEC/EN60529, NEMA 4	
Electrical connection	M12, DIN 43650 A or Delphi (Packard) Metri-Pack connector (1)	
Fluid connection	G 1/4 A (male) conforming to ISO7 or 1/4"-18 NPT male (3)	
Catalog number	<p>XML K●●●B2C●●, XML K●●●B2C●●TQ (4)</p> <p>XML K●●●B2D●●, XML K●●●B2D●●TQ (4)</p> <p>XML K●●●P2C●●, XML K●●●P2C●●TQ (4)</p> <p>XML K●●●P2D●●, XML K●●●P2D●●TQ (4)</p> <p>XML K●●●P2P●●, XML K●●●P2P●●TQ (4)</p>	
Pages	16	

Other versions

(1) For other connections (such as AMP connector or cable), consult the Sensor Competency Center at 1-800-435-2121.
 (2) Phoenix Contact QUICKON type integrated connection.
 (3) For other fluid connections (such as G 1/4 A BSP male or 1/4" NPTF female), refer to "Interpretation of the Catalog Number" on page 22, or consult the Sensor Competency Center at 1-800-435-2121. Component materials of units in contact with the fluid: see page 23.
 (4) Sold in lots of 25, with a minimum order of 50 pcs.

Control circuits	
Air, water, hydraulic oils, corrosive fluids	Air, fresh water
Units without display	Units without display
Pressure transmitters Analog output 4–20 mA or 0–10 V	Pressure and vacuum switches Factory set switching thresholds Solid-state NPN or PNP output



Air, fresh water, sea water, hydraulic oils, corrosive fluids, –15 to +125 °C (5.0 to 257.0 °F)		Air, fresh water, sea water, hydraulic oils, corrosive fluids, –15 to +125 °C (5.0 to 257.0 °F)	
–1 to 400 bar (–14.5 to 5800 psi)		–1 to 400 bar (–14.5 to 5800 psi)	
Ø 22.8 x 70.1 (Ø 0.90 x 2.76)	Ø 22.8 x 85 (Ø 0.90 x 3.35)	Ø 22.8 x 70.1 (Ø 0.90 x 2.76)	Ø 22.8 x 85 (Ø 0.90 x 3.35)
Analog, 4–20 mA or 0–10 V		Solid-state, PNP or NPN normally closed (NC) output 150 mA, 12/24 V \overline{DC}	
IP66, IP67 conforming to IEC/EN60529, NEMA4		IP66, IP67 conforming to IEC/EN60529, NEMA4	
M12 connector (1)	Integrated quick connection (2)	M12 connector (1)	Integrated quick connection (2)
1/4" NPT male conforming to ISO7 (3)		1/4" NPT male conforming to ISO7 (3)	
XMLG●●●D23 XMLG●●●D23●●TQ (4) XMLG●●●D73 XMLG●●●D73TQ (4)	XMLG●●●Q23●●TQ (4)	XMLG●●●D33●●TQ (4) XMLG●●●D43●●TQ (4)	XMLG●●●Q33●●TQ (4) XMLG●●●Q43●●TQ (4)
24		28	

(1) For other connections (such as AMP connector or cable), consult the Sensor Competency Center at 1-800-435-2121.
(2) Phoenix Contact QUICKON type integrated connection.
(3) For other fluid connections (such as G 1/4 A BSP male or 1/4" NPTF female), refer to "Interpretation of the Catalog Number" on page 22, or consult the Sensor Competency Center at 1-800-435-2121. Component materials of units in contact with the fluid: see page 23.
(4) Sold in lots of 25, with a minimum order of 50 pcs.

Applications	Type of installation	Control circuits		
	Fluids controlled	Air, water, hydraulic oils, corrosive fluids		
	Type of sensor and features	Configurable units with digital display		
		Pressure transmitters Output current 4–20 mA	Pressure transmitters Output voltage 0–10 V	Universal sensors Regulation between 2 thresholds (adjustable differential) Solid-state and analog output current 4–20 mA



Fluid characteristics	Air, fresh water, sea water, hydraulic oils, corrosive fluids, –15 to +80 °C (5.0 to 176.0 °F)		
Sizes	–1 to 600 bar (–14.5 to 8700 psi)		
Dimensions of case mm (in.)	Width x height x depth (1.81 x 4.45 x 2.28)		
Type of output	Analog, 4–20 mA	Analog, 0–10 V	Solid-state, PNP or NPN, 200 mA, 24 V _{DC} output Analog output 4–20 mA
Degree of protection	IP67		
Electrical connection	M12 connector		
Fluid connection	G 1/4 A (BSP) or 1/4" NPT or SAE 7/16-20 UNF female		
Catalog number	XMLF●●●D201●	XMLF●●●D211●	XMLF●●●D202●
Pages	38		
Other versions	For pressure transmitters, electronic pressure switches, and vacuum switches with alternative tapped fluid entries, consult the Sensor Competency Center at 1-800-435-2121.		

Control circuits

Air, water, hydraulic oils, corrosive fluids

Configurable units with digital display

Units without display

Universal sensors
Regulation between 2 thresholds (adjustable differential)
Solid-state and analog output voltage 0–10 V

Dual stage pressure and vacuum switches (solid-state outputs)
Detection of 2 thresholds and adjustable differential for each threshold

Pressure and vacuum switches with 2.5 A relay outputs
Regulation between 2 thresholds (adjustable differential)

Pressure transmitters
Analog output 4–20 mA

Pressure and vacuum switches with solid-state output
Regulation between 2 thresholds (adjustable differential)



Air, fresh water, sea water, hydraulic oils, corrosive fluids, –15 to +80 °C (5.0 to 176.0 °F)

Air, fresh water, sea water, hydraulic oils, corrosive fluids, –15 to +80 °C (5.0 to 176.0 °F)

–1 to 600 bar (–14.5 to 8700 psi)

–1 to 600 bar (–14.5 to 8700 psi)

46 x 113 x 58 (1.81 x 4.45 x 2.28)

46 x 119 x 58 (1.81 x 4.69 x 2.28)

sizes –1 to 25 bar: Ø 40 x 87 (Ø 1.57 x 3.43)
sizes 60 to 600 bar: Ø 40 x 97 (Ø 1.57 x 3.82)

Solid-state, PNP or NPN, 200 mA, 24 V $\overline{\text{DC}}$ output
Analog output 0–10 V

2 solid-state, PNP or NPN, 200 mA, 24 V $\overline{\text{DC}}$ outputs

Relay output
2.5 A, 120 V \sim

Analog, 4–20 mA

Solid-state, NPN or PNP, normally closed (NC) output

IP67

IP65

M12 connector

SAE 7/8-16UN connector

DIN 43650A or M12 connector

G 1/4 A (BSP) or 1/4" NPT or SAE 7/16-20 UNF female

1/4" NPT male, G 1/4 A (BSP) male

XMLF●●●D212●

XMLF●●●D203●

XMLF●●●E204●

XMLF●●●●●23

XMLF●●●●●33
XMLF●●●●●43

38

68

72

For pressure transmitters, electronic pressure switches, and vacuum switches with alternative tapped fluid entries, consult the Sensor Competency Center at 1-800-435-2121.

Steps for Selecting a Pressure Switch



The deciding factors in the selection of a pressure switch for use on control circuits¹ depend on the requirements of the application. Consider the following requirements to help determine the appropriate catalog number for your application.

1. **Setpoints:** Do you want to control/monitor one setpoint or two?

- One setpoint: fixed differential
- Two setpoints: adjustable differential

Fixed differential

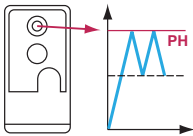

2. **Fluids:** What fluids do you want to control?

- Hydraulic oil, air, fresh water ≤ 70 °C (158 °F)
- Steam
- Hydraulic oil, air, fresh water ≤ 160 °C (320 °F)
- Corrosive fluid ≤ 160 °C (320 °F)
- Sea water ≤ 70 °C (158 °F)
- Viscous fluid ≤ 160 °C (320 °F)
- Sea water ≤ 160 °C (320 °F)

Adjustable differential

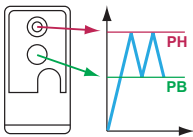

Ensure that the wetted parts of the switch are compatible with the system fluid.

3. **Pressure Range:** What pressure range does the system experience?

Note: Select pressure settings that fall within the middle 80% of the pressure range. The pressure applied during a normal cycle should never exceed the maximum range value listed for the switch. Pressure surges should be less than the maximum allowable pressure listed for the switch.

Rated Pressure	
psi	bar
0 to 0.725	0 to 0.05
0 to 5.075	0 to 0.35
-14.5 to -4.06	-1 to -0.28
-14.5 to -2.03	-1 to -0.14
-2.9 to -0.029	-0.2 to -0.02
-7.25 to 72.5	-0.5 to 5
0 to 14.5	0 to 1
0 to 36.25	0 to 2.5
0 to 58	0 to 4
0 to 145	0 to 10
0 to 290	0 to 20
0 to 507.5	0 to 35
0 to 580	0 to 40
0 to 1015	0 to 70
0 to 2320	0 to 160
0 to 4350	0 to 300
0 to 7250	0 to 500

4. **Surges:** How frequent are surges in your system, and what is their maximum pressure level? Applications experiencing frequent or high-pressure surges may require a device with a higher pressure range.

¹ For switches used on power circuits, see catalog 9013CT9701, *Commercial Pressure Switches, Class 9013 Types F and G*.

-
1. **Enclosure:** What degree of enclosure protection do you need?
 - IP65
 - IP66
 - IP67
 2. **Output:** What type of output do you require?
 - Analog, 4–20 mA
 - Solid State, NPN
 - Solid State, PNP
 - Analog, 0–10V
 - AC Relay 120V
 - DC Analog, 4–20 mA, shunt calibration
 - DC Analog, 4–20 mA digital single stage
 - DC Analog, 0–10 V, shunt calibration
 - DC Analog, 0–10 V, digital single stage
 - DC digital dual stage
 3. **Electrical Connection:** What type of electrical connection do you require?
 - M12
 - Integrated quick connect
 - Delphi (Packard) Metri-Pack
 - DIN 43650A
 - 7/8 16 UN2A
 4. **Pressure Connection:** What type of pressure connection do you require?
 - 1/4" - 18 NPTF (female)
 - 1/2" - 14 NPT
 - G 1/4 BSP (female) metric thread
 - 7/16"-20 UNF-2B
 5. **Special Features:** Do you require any special features?

When switches must be factory set and only one setting is identified, specify whether this setting is on rising or falling pressure. State the switching threshold settings when ordering.

Functions

Pressure transmitters

The function of pressure transmitters is the control and measurement of pressure or vacuum levels in hydraulic or pneumatic systems. They transform the pressure into an analog electrical signal which is proportional to the pressure measured. Their high precision makes them suitable for all industrial applications requiring pressure/vacuum display, control, or regulation. Also very robust, they are equally suitable for applications involving high operating rates.

Pressure and vacuum switches

The function of electronic pressure and vacuum switches is the control or regulation of pressure or vacuum levels in hydraulic or pneumatic systems. They transform the pressure change into a digital output signal when the preset pressure or vacuum points are reached. The very wide adjustment range for the setpoints characterize these electronic switches. Their robustness, along with their excellent adherence to the set values over time, make them ideal for applications involving high operating rates. In addition, the high repeat accuracy and fast response time of these sensors make them equally suitable for applications requiring accurate pressure regulation and monitoring.

Universal sensors

Universal sensors are electronic pressure and vacuum switches with digital output, which also include an analog output identical to that of the pressure transmitters.

Operating principle

Pressure transmitters

The electrical signal from the pressure transmitter (signal proportional to the monitored pressure) is amplified, calibrated, and output as a standard 4–20 mA or 0–10 V analog signal (depending on the model).

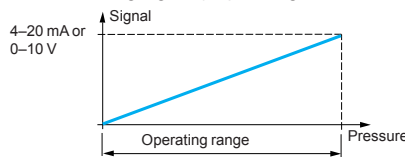

Pressure and vacuum switches

Designed for regulation between 2 thresholds, these switches have both a high setpoint (PH) and a low setpoint (PB). Both of these points can be independently adjusted (adjustable differential). The difference (differential) between the two setpoints can be small or large. Since the switches are electronic, they have no mechanical moving parts.

Operating principle with solid-state NC outputs

Pressure switches with digital output

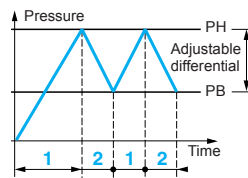

— Adjustable value
PH = high setpoint
PB = low setpoint

- 1 Output on
- 2 Output off

Dual stage pressure switches

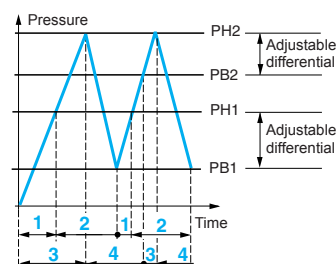

Vacuum switches with digital output

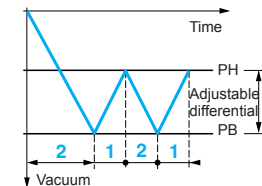

- 1 Output on
- 2 Output off

— Adjustable value
PH1 = high setpoint 1st stage
PB1 = low setpoint 1st stage
PH2 = high setpoint 2nd stage
PB2 = low setpoint 2nd stage
1 Output 1st stage on
2 Output 1st stage off
3 Output 2nd stage on
4 Output 2nd stage off

Terminology

Measuring range

The measuring range (MR) of a pressure sensor corresponds to the difference between the upper and lower values measured by the load cell. It ranges between 0 and the pressure corresponding to the size of the sensor.

Operating range

The **operating range of a pressure transmitter** corresponds to its measuring range. Within this range, its analog output signal varies between 4 and 20 mA or 0 and 10 V, and is proportional to the measured pressure.

The **operating range of a pressure or vacuum switch** is the difference between the values of the minimum low setpoint (PB) and the maximum high setpoint (PH).

Precision

This includes linearity, hysteresis, repeat accuracy, and setting tolerances. It is expressed as a percentage of the measuring range of the load cell (%MR).

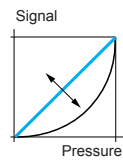

The **linearity** is the maximum deviation between the real transmitted curve and the ideal curve.

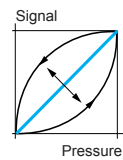

The **hysteresis** is the maximum deviation between the rising pressure curve and the falling pressure curve.

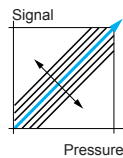

The **repeat accuracy** is the maximum drift encountered at varying pressures under given conditions.

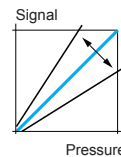
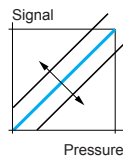

The **setting tolerances** are the manufacturer's tolerances with regard to the zero point and sensitivity (gradient of output signal curve from pressure transmitter).

Temperature drift

The precision of a pressure sensor is susceptible to variation due to the operating temperature.

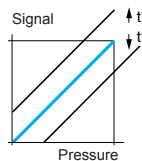

Zero point drift, proportional to the temperature, is expressed as %MR/°C.

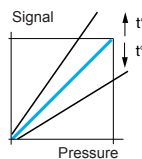

Sensitivity drift, proportional to the temperature, is expressed as %MR/°C.

Terminology (continued)

Switching point on rising pressure (PH)

This is the upper pressure setting at which the output of the electronic pressure or vacuum switch changes state on rising pressure.

Switching point on falling pressure (PB)

This is the lower pressure setting at which the output of the electronic pressure or vacuum switch changes state on falling pressure.

Differential

This is the difference between the switching point on rising pressure (PH) and the switching point on falling pressure (PB). The low point can be set at the values indicated on the operating curves shown on the product pages.

Switches with fixed differential

Depending on the switch, either the high or low operating point is adjustable, and the other operating point follows. The window is fixed.

Switches with adjustable differential

An adjustable differential allows independent setting of both operating points.

Spread

For dual-stage switches, the spread indicates the difference between the two operating points on rising pressure (PH2 and PH1) and, for vacuum switches, the difference between the two operating points on falling pressure (PB2 and PB1).

Differential-Pressure Sensing

Switches for differential-pressure sensing measure the difference between two pressures.

Size

Pressure transmitters and pressure switches

This is the maximum value of the operating range.

Vacuum transmitters and vacuum switches

This is the minimum value of the operating range.

Accuracy (switches with setting scale)

The tolerance between the point at which the switch actuates its contacts and the value indicated on the setting scale. Where very high setting accuracy is required (initial installation of the product), it is recommended to use separate measuring equipment (pressure gauge, etc.).

Repeat accuracy

This is the variation of the operating point of the pressure or vacuum switch between several successive operations, or the tolerance between two consecutive switching operations.

Drift (F)

The tolerance of the operating point throughout the entire service life of the switch.

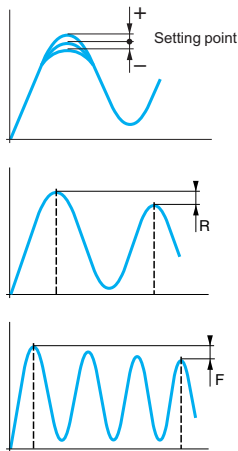

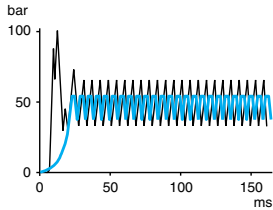
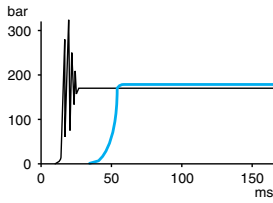

Terminology (continued)

Maximum allowable pressure

The maximum value of an accidental pressure surge of very short duration (a few milliseconds).

Example 1: With destructive (burst) pressure level

— Without damping device
— With damping device

Example 2: With destructive (burst) pressure level and destructive pressure oscillations

Maximum permissible accidental pressure

This is the maximum pressure (excluding pressure surges) that the sensor can occasionally withstand without permanent damage.

Maximum allowable pressure per cycle (Ps)

The maximum pressure level per cycle that the switch can withstand for optimum service life.

Surge

A surge is a high rate of rise in pressure, normally of short duration, caused by starting a pump or by opening and closing a valve. Depending on frequency and duration, surge can reduce service life. Extremely high rates of rise in pressure can be damaging even if they are within the limits of the maximum allowable pressure.

Destruction pressure

Also called *burst pressure*, the destruction pressure is the pressure value which, if exceeded, is likely to cause serious damage to the sensor—such as leaking, bursting, or permanent damage.

Load resistance of pressure transmitters

The supply voltage and load resistance of a pressure transmitter must be selected according to the following formula:

$$R_{\text{load}} = \frac{U_{\text{supply}} - U_{\text{supply min.}}}{0.02 \text{ A}} \quad (U_{\text{supply min.}} = 11 \text{ V for XMLE and } 17 \text{ V for XMLF})$$

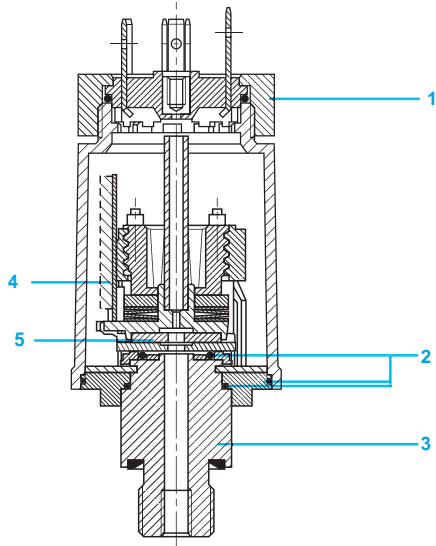

Introduction

Type XMLK pressure transmitters are characterized by their ceramic pressure-measuring cell. Deformation, caused by pressure, changes the resistance of the resistors of a Wheatstone bridge silk-screened on the ceramic. The change in resistance is then processed by the integrated electronics to provide an analog output signal.

- 1 Electrical connection: for example, DIN EN 175301-803-A connector
- 2 Seals
- 3 Threaded fluid connection
- 4 Hybrid electronics
- 5 Ceramic measuring cell

Functions

XMLK pressure transmitters have an analog output, 4–20 mA or 0–10 V, which is proportional to the measuring range.

These compact products are available with various types of electrical connectors and fluid connections.

Standard versions are available calibrated in both bar and psi. The bulk packaging alternative offers an excellent price/performance ratio. XMLK electronic pressure sensors are designed for simple pumping applications and are well suited for pump equipment manufacturers.

Environmental Specifications		
Conformity to standards		CE IEC/EN 60947-1, IEC/EN 60947-5-1 EN 50081-1, EN 50082-2, EN 61000-6-2
Product certifications		UL: File E97729, CCN NKPZ CSA: File 240515, Class 3211-03
Rated supply voltage	V	24 V $\overline{\text{---}}$
Voltage limits		4–20 mA: 8–33 V $\overline{\text{---}}$ 0–10 V: 16.2–33 V $\overline{\text{---}}$
Current consumption		4–20 mA: < 20 mA 0–10 V: < 6 mA
Output signal		4–20 mA, 0–10 V
Protective treatment		Standard version "TC"
Ambient air temperature	For operation	°C (°F) 0 to + 80 (32 to 176)
	For storage	°C (°F) –25 to + 85 (13 to 185)
Fluids or products controlled		Air, fresh water (0 to + 80 °C / 32 to 176 °F)
Component materials in contact with fluid		Steel, type AISI 303 (stainless steel) nitrile (NBR)
Operating position		All positions
Vibration resistance		20 gn (9–2000 Hz) conforming to IEC 60068-2-6
Shock resistance		25 gn (half sine wave 11 ms) conforming to IEC 60068-2-27
Resistance to electromagnetic interference	Electrostatic discharges	Standard EN 61000-4-2, 8 kV in air, 6 kV on contact
	Radiated electromagnetic fields	Standard EN 61000-4-3, >10 V/m, 80–1000 MHz
	Fast transients	Standard EN 61000-4-4, 2 kV
	Surges	Standard EN 61000-4-5, 500 V 12 Ω , 1 kV 42 Ω
	Conducted disturbances, induced by radio frequency fields	Standard EN 61000-4-6, 10 V 0.15–80 MHz
Magnetic fields		Standard EN 61000-4-8, 30 A/m, 50 Hz
Electrical protection		Protected against reverse polarity and load short-circuit. For use on Class 2 circuit.
Rated impulse withstand voltage	kV	0.5
Degree of protection		IP 65 conforming to IEC/EN 60529, NEMA 4
Output response time	ms	< 2
Repeat accuracy		$\pm 0.3\%$ of the measuring range
Precision (resolution)		Combined sum of linearity, hysteresis, and repeat accuracy $\leq \pm 0.5\%$ of the measuring range Setting tolerance of zero point and measuring range limit $< \pm 1\%$ of the measuring range
Drift	Of the zero point	$< \pm 0.04\%$ of the measuring range/°K
	Of the sensitivity	$< \pm 0.03\%$ of the measuring range/°K
Service life	Operating cycles	> 10 million (varies based on application and environment)
Fluid connection		G 1/4 A (male) conforming to ISO 7, or 1/4"-18 NPT male
Electrical connection		Connector, either M12, DIN 43650A (DIN EN 175301-803-A) or Delphi (Packard) Metri-Pack

Interpretation of the catalog number								
Note: Use this table only to interpret the catalog number. Some combinations are not available.								
XMLK	100		P	2	D	2	3	TQ
Units without display	Rated pressure		Unit of pressure	O-Ring	Electrical connection	Output	Fluid connection	Bulk pack
36 mm (1.42 in.) diameter	Code	psi	bar					
	006		0–6	B: bar	2: NBR (Nitrile)	C: DIN 43650A	2: Analog, 4–20 mA	1: G 1/4 A (male)
	010		0–10	P: psi		D: M12	7: Analog, 0–10 V	3: 1/4"-18 NPT (male)
	016		0–16			P: Delphi (Packard) Metri-Pack		
	025		0–25					
	100	0–100						
	150	0–150						
	200	0–200						
	300	0–300						

Pressure transmitters type XMLK, bar version, DIN 43650A connector or M12 connector ⁽¹⁾

DIN 43650A connector

M12 connector

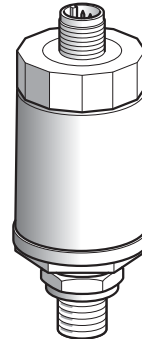
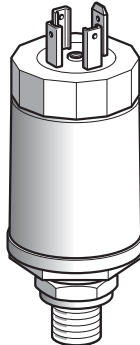

Pressure range	0–6 bar (0–87 psi)	0–10 bar (0–145 psi)	0–16 bar (0–232 psi)	0–25 bar (0–362.5 psi)	
Selection					
Pressure transmitters XMLK, DIN 43650A connector					
Sold in packs of:	1	XMLK006B2C21	XMLK010B2C21	XMLK016B2C21	XMLK025B2C21
	bulk (2)	XMLK006B2C21TQ	XMLK010B2C21TQ	XMLK016B2C21TQ	XMLK025B2C21TQ
Pressure transmitters XMLK, M12 connector					
Sold in packs of:	1	XMLK006B2D21	XMLK010B2D21	XMLK016B2D21	XMLK025B2D21
	bulk (2)	XMLK006B2D21TQ	XMLK010B2D21TQ	XMLK016B2D21TQ	XMLK025B2D21TQ
Fluid connection (3)	G 1/4 A (male)				
Weight, kg (lb)	0.110 (.25)	0.110 (.25)	0.110 (.25)	0.110 (.25)	
Additional specifications not shown under general specifications					
Rated supply voltage	24 V \square				
Voltage limits	8–33 V \square				
Output (4)	4–20 mA, 2-wire technique				
Current consumption	< 20 mA				
Maximum permissible accidental pressure	12 bar (174 psi)	20 bar (290 psi)	32 bar (464 psi)	50 bar (725 psi)	
Destruction pressure	18 bar (261 psi)	30 bar (435 psi)	48 bar (696 psi)	75 bar (1087.5 psi)	
Electrical connection	DIN 43650A connector	EN 175301-803-A (male). For suitable female connector see accessories on page 20.			
	M12 connector	M12, 3-pin male. For suitable female connectors, including pre-wired versions, see accessories on page 20.			

(1) For other types of electrical connections, consult the Sensor Competency Center at 1-800-435-2121.

(2) Sold in lots of 25, minimum quantity 50.

(3) For other types of fluid connections, consult the Sensor Competency Center at 1-800-435-2121.

(4) For other types of output, consult the Sensor Competency Center at 1-800-435-2121.

Output curve

XMLK0●●B2●21

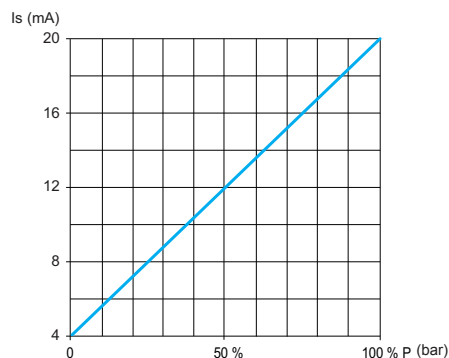

Connector wiring: 2-wire technique (4–20 mA)

DIN

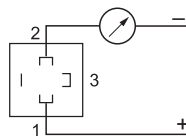

M12

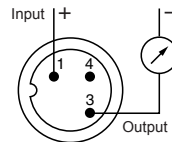

OsiSense® XML

Electronic pressure sensors
XMLK pressure transmitters, bar version
With analog output 0–10 V
Sizes 0 to 25 bar (0 to 362 psi)

Pressure transmitters type XMLK, bar version, DIN 43650A connector or M12 connector (1)

DIN 43650A connector

M12 connector

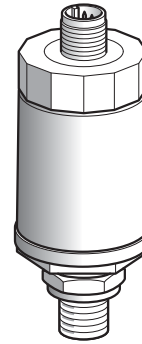
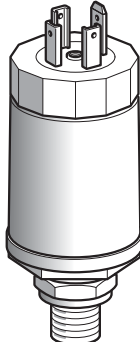

Pressure range	0–6 bar (0–87 psi)	0–10 bar (0–145 psi)	0–16 bar (0–232 psi)	0–25 bar (0–362.5 psi)
----------------	--------------------	----------------------	----------------------	------------------------

Selection

Pressure transmitters XMLK, DIN 43650A connector

Sold in packs of:	1	XMLK006B2C71	XMLK010B2C71	XMLK016B2C71	XMLK025B2C71
	bulk (2)	XMLK006B2C71TQ	XMLK010B2C71TQ	XMLK016B2C71TQ	XMLK025B2C71TQ

Pressure transmitters XMLK, M12 connector

Sold in packs of:	1	XMLK006B2D71	XMLK010B2D71	XMLK016B2D71	XMLK025B2D71
	bulk (2)	XMLK006B2D71TQ	XMLK010B2D71TQ	XMLK016B2D71TQ	XMLK025B2D71TQ

Fluid connection (3)	G 1/4 A (male)
----------------------	----------------

Weight, kg (lb)	0.110 (.25)	0.110 (.25)	0.110 (.25)	0.110 (.25)
-----------------	-------------	-------------	-------------	-------------

Additional specifications not shown under general specifications

Rated supply voltage	24 V $\overline{\text{---}}$			
Voltage limits	16.2–33 V $\overline{\text{---}}$			
Output (4)	0–10 V, 3-wire technique			
Current consumption	< 6 mA			
Maximum permissible accidental pressure	12 bar (174 psi)	20 bar (290 psi)	32 bar (464 psi)	50 bar (725 psi)
Destruction pressure	18 bar (261 psi)	30 bar (435 psi)	48 bar (696 psi)	75 bar (1087.5 psi)
Electrical connection	DIN 43650A connector	EN 175301-803-A (male) . For suitable female connector see accessories on page 20.		
	M12 connector	M12, 3-pin male. For suitable female connectors, including pre-wired versions, see accessories on page 20.		

(1) For other types of electrical connections, consult the Sensor Competency Center at 1-800-435-2121.

(2) Sold in lots of 25, minimum quantity 50.

(3) For other types of fluid connections, consult the Sensor Competency Center at 1-800-435-2121.

(4) For other types of output, consult the Sensor Competency Center at 1-800-435-2121.

Output curve

XMLK0●●B2●71

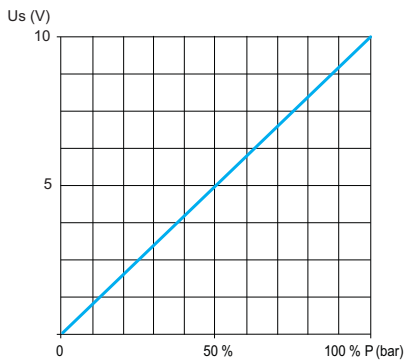

Connector wiring: 3-wire technique (0–10 V)

DIN

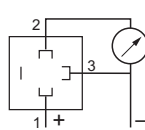

M12

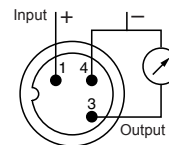

OsiSense® XML

Electronic pressure sensors
XMLK pressure transmitters, psi version
With analog output 4–20 mA
Sizes 0 to 300 psi (0 to 20.7 bar)

Pressure transmitters type XMLK, psi version, DIN 43650A, M12 or Metri-Pack connector (1)

DIN 43650A connector M12 connector Metri-Pack connector

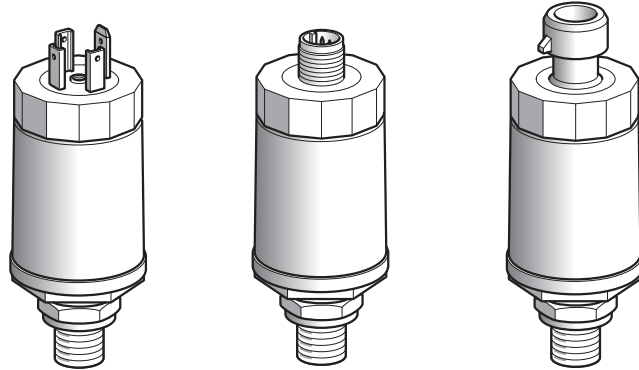

Pressure range	0–100 psi (0–6.9 bar)	0–150 psi (0–10.3 bar)	0–200 psi (0–13.8 bar)	0–300 psi (0–20.7 bar)
----------------	-----------------------	------------------------	------------------------	------------------------

Selection

Pressure transmitters XMLK, DIN 43650A connector

Sold in packs of:	1	XMLK100P2C23	XMLK150P2C23	XMLK200P2C23	XMLK300P2C23
	bulk (2)	XMLK100P2C23TQ	XMLK150P2C23TQ	XMLK200P2C23TQ	XMLK300P2C23TQ

Pressure transmitters XMLK, M12 connector

Sold in packs of:	1	XMLK100P2D23	XMLK150P2D23	XMLK200P2D23	XMLK300P2D23
	bulk (2)	XMLK100P2D23TQ	XMLK150P2D23TQ	XMLK200P2D23TQ	XMLK300P2D23TQ

Pressure transmitters XMLK, Metri-Pack connector

Sold in packs of:	1	XMLK100P2P23	XMLK150P2P23	XMLK200P2P23	XMLK300P2P23
	bulk (2)	XMLK100P2P23TQ	XMLK150P2P23TQ	XMLK200P2P23TQ	XMLK300P2P23TQ

Fluid connection (3)	1/4"-18 NPT male			
Weight, kg (lb)	0.110 (.25)	0.110 (.25)	0.110 (.25)	0.110 (.25)

Additional specifications not shown under general specifications

Rated supply voltage	24 V $\bar{\text{---}}$			
Voltage limits	8–33 V $\bar{\text{---}}$			
Output (4)	4–20 mA, 2-wire technique			
Current consumption	< 20 mA			
Maximum permissible accidental pressure	200 psi (13.8 bar)	300 psi (20.7 bar)	400 psi (27.5 bar)	600 psi (41 bar)
Destruction pressure	300 psi (20.7 bar)	450 psi (31 bar)	600 psi (41 bar)	900 psi (62 bar)
Electrical connection	DIN 43650A connector	EN 175301-803-A (male) . For suitable female connector see accessories on page 20		
	M12 connector	M12, 3-pin male. For suitable female connectors, including pre-wired versions, see accessories on page 20.		
	Metri-Pack connector	3-pin Delphi (Packard) Metri-Pack 150 series.		

(1) For other types of electrical connections, consult the Sensor Competency Center at 1-800-435-2121.

(2) Sold in lots of 25, minimum quantity 50.

(3) For other types of fluid connections, consult the Sensor Competency Center at 1-800-435-2121.

(4) For other types of output, consult the Sensor Competency Center at 1-800-435-2121.

Output curve

XMLK1●●P2●23

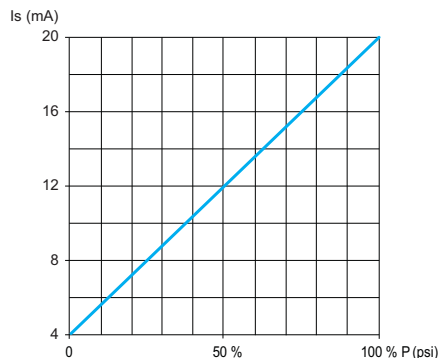

Connector wiring: 2-wire technique (4–20 mA)

DIN

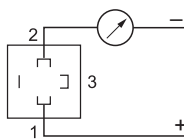

M12

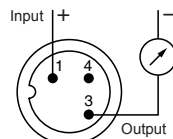

Metri-Pack

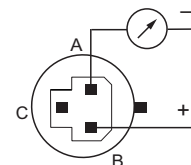

OsiSense® XML

Electronic pressure sensors
XMLK pressure transmitters, psi version
With analog output 0–10 V
Sizes 0 to 300 psi (0 to 20.7 bar)

Pressure transmitters type XMLK, PSI version, DIN 43650A, M12 or Metri-Pack connector (1)

DIN 43650A connector M12 connector Metri-Pack connector

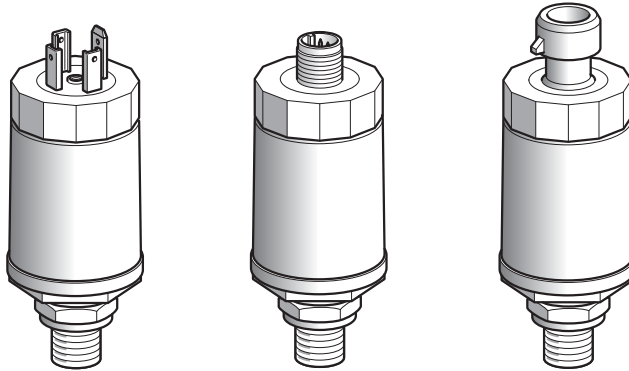

Pressure range	0–100 psi (0–6.9 bar)	0–150 psi (0–10.3 bar)	0–200 psi (0–13.8 bar)	0–300 psi (0–20.7 bar)
----------------	-----------------------	------------------------	------------------------	------------------------

Selection

Pressure transmitters XMLK, DIN 43650A connector

Sold in packs of:	1	XMLK100P2C73	XMLK150P2C73	XMLK200P2C73	XMLK300P2C73
	bulk (2)	XMLK100P2C73TQ	XMLK150P2C73TQ	XMLK200P2C73TQ	XMLK300P2C73TQ

Pressure transmitters XMLK, M12 connector

Sold in packs of:	1	XMLK100P2D73	XMLK150P2D73	XMLK200P2D73	XMLK300P2D73
	bulk (2)	XMLK100P2D73TQ	XMLK150P2D73TQ	XMLK200P2D73TQ	XMLK300P2D73TQ

Pressure transmitters XMLK, Metri-Pack connector

Sold in packs of:	1	XMLK100P2P73	XMLK150P2P73	XMLK200P2P73	XMLK300P2P73
	bulk (2)	XMLK100P2P73TQ	XMLK150P2P73TQ	XMLK200P2P73TQ	XMLK300P2P73TQ

Fluid connection (3)	1/4"-18 NPT male			
Weight, kg (lb)	0.110 (.25)	0.110 (.25)	0.110 (.25)	0.110 (.25)

Additional specifications not shown under general specifications

Rated supply voltage	24 V $\overline{\text{---}}$			
Voltage limits	16.2–33 V $\overline{\text{---}}$			
Output (4)	0–10 V, 3-wire technique			
Current consumption	< 6 mA			
Maximum permissible accidental pressure	200 psi (13.8 bar)	300 psi (20.7 bar)	400 psi (27.5 bar)	600 psi (41 bar)
Destruction pressure	300 psi (20.7 bar)	450 psi (31 bar)	600 psi (41 bar)	900 psi (62 bar)
Electrical connection	DIN 43650A connector	EN 175301-803-A (male) . For suitable female connector see accessories on page 20.		
	M12 connector	M12, 3-pin male. For suitable female connectors, including pre-wired versions, see accessories on page 20.		
	Metri-Pack connector	3-pin Delphi (Packard) Metri-Pack 150 series.		

(1) For other types of electrical connections, consult the Sensor Competency Center at 1-800-435-2121.
 (2) Sold in lots of 25, minimum quantity 50.
 (3) For other types of fluid connections, consult the Sensor Competency Center at 1-800-435-2121.
 (4) For other types of output, consult the Sensor Competency Center at 1-800-435-2121.

Output curve

XMLK1●●P2●73

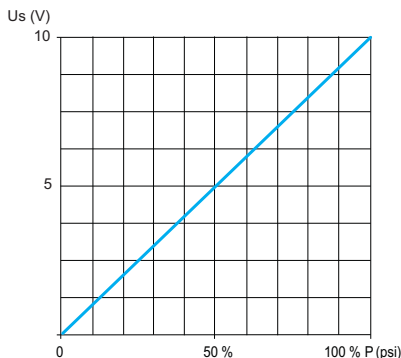

Connector wiring: 3-wire technique (0–10 V)

DIN

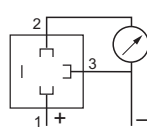

M12

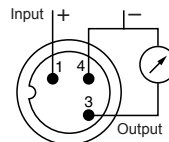

Metri-Pack

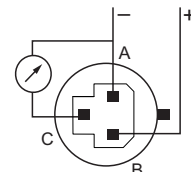

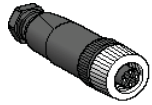

XZ CC12FDM40B

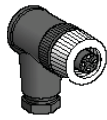

XZ CC12FCM40B



XZ CC43FCP40B

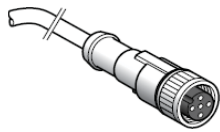

XZ CP1141L10

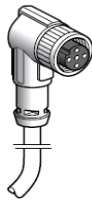

XZ CP1241L5

Connection accessories

Description	Type	Reference	Weight kg (lb)
M12 female connector, metal clamping ring (1)	Straight	XZCC12FDM40B	0.020 (0.04)
	Elbowed	XZCC12FCM40B	0.020 (0.04)
DIN 43650A female connector (1)		XZCC43FCP40B	0.035 (0.08)

Description	Cable Length	Reference	Weight kg (lb)
Pre-wired M12, straight female connectors	2 m	XZCP1141L2	0.090 (0.20)
	5 m	XZCP1141L5	0.190 (0.42)
	10 m	XZCP1141L10	0.370 (0.82)
Pre-wired M12, elbowed female connectors	2 m	XZCP1241L2	0.090 (0.20)
	5 m	XZCP1241L5	0.190 (0.42)
	10 m	XZCP1241L10	0.370 (0.82)

(1) Connector with screw terminal connections.

Connector wiring (pressure sensor connector pin view)

Pressure transmitters XMLK

2-wire technique (4–20 mA)

DIN

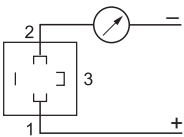

M12

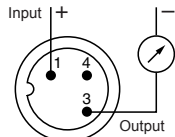

Metri-Pack

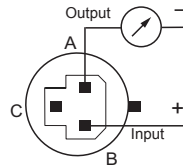

3-wire technique (0–10 V)

DIN

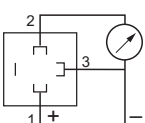

M12

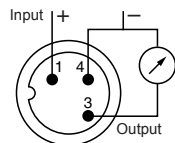

Metri-Pack

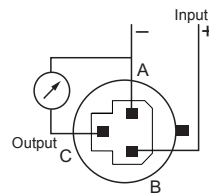

Dimensions

XMLK, DIN connector

NPT

G 1/4 A (male)

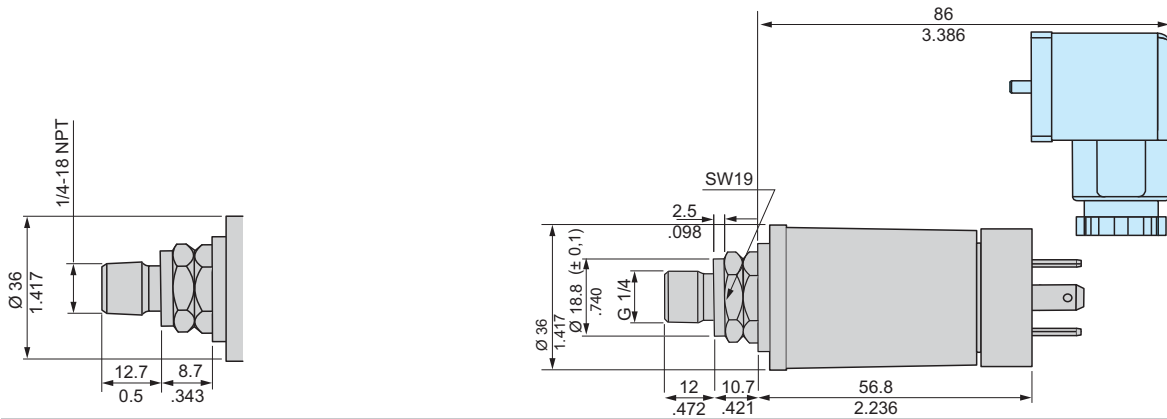

XMLK, M12 connector

NPT

G 1/4 A (male)

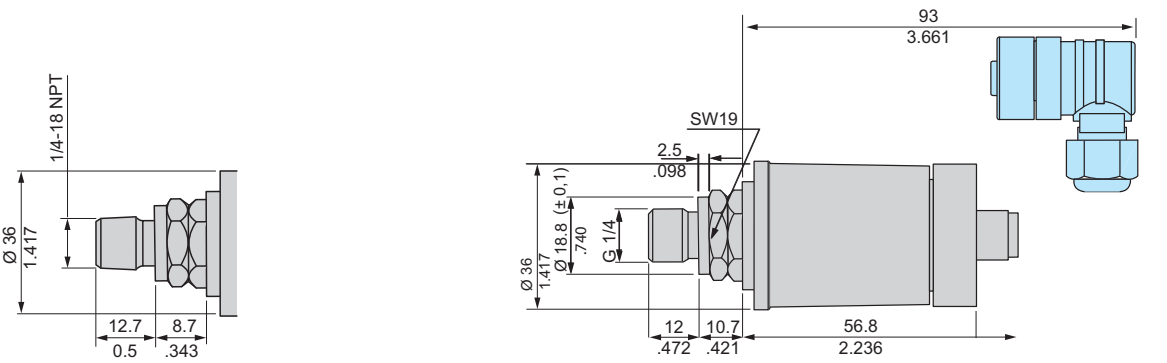

XMLK, Metri-Pack connector

NPT

G 1/4 A (male)

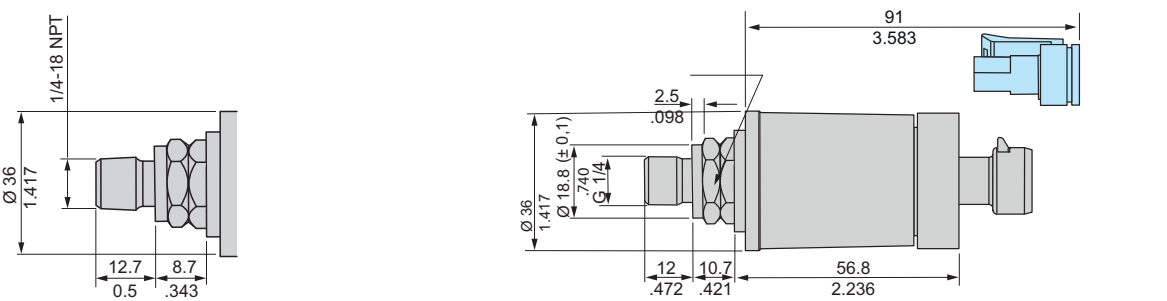

Dimensions = mm / in.

OsiSense® XML

Electronic pressure sensors

Type XMLG

For control circuits

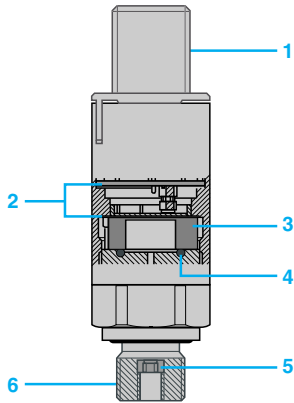

Introduction

XMLG pressure transmitters and pressure switches are characterized by their ceramic pressure measuring cell. The deformation caused by the pressure is transmitted to the resistors of a Wheatstone bridge silk-screened on the ceramic. The change in resistance is then processed by the integrated electronics for providing either a digital or analog output signal.

- 1 Electrical connection, for example: M12
- 2 Electronics with EMC protection
- 3 Ceramic measuring cell
- 4 Seals
- 5 Leakage protection
- 6 Threaded connection

Functions

Pressure transmitters have an analog 4–20 mA or 0–10 V output that is proportional to the measuring range.

Pressure and vacuum switches have a solid-state NPN or PNP normally closed (NC) output.

An anti-leakage system integrated in products for pressures ≥ 40 bar prevents fluid leakage in the event of the measuring cell destructive pressure being exceeded.

These compact products that offer excellent EMC characteristics are particularly suited to difficult industrial environments.

Important ordering requirement

XMLG pressure and vacuum switches are factory set; the upper and lower switching thresholds must be specified when ordering.

Bulk packs are mainly intended for machine manufacturers.

Interpretation of the Catalog Number—XMLG

XMLG	100	D	2	3	TQ	
Units without display, 22.8 mm diameter	Rated pressure		Electrical connection	Output	Fluid connection	Bulk pack
Code	psi	bar				
M01	-14.5 to 0	-1 to 0	D: M12	2: Analog, 4–20 mA	1: G 1/4 A (BSP male)	
001	0 to 14.5	0 to 1	Q: Integrated quick connect	3: Solid state, NPN	3: 1/4" NPT male	
006	0 to 87	0 to 6		4: Solid state, PNP	6: 1/4" NPTF female	
010	0 to 145	0 to 10		7: Analog, 0–10 V (bulk packs only)	7: 7/16-20 UNF male	
016	0 to 232	0 to 16				
025	0 to 362.5	0 to 25				
100	0 to 1450	0 to 100				
250	0 to 3625	0 to 250				
400	0 to 5800	0 to 400				

NOTE: Use this table only to interpret the catalog number. Some combinations are not available.

Environmental specifications		
Conformity to standards		CE IEC/EN 60947-1, IEC/EN 60947-5-1 EN 50081-1, EN 50082-2, EN 61000-6-2
Product certifications		UL, CSA
Rated supply voltage	Transmitters 4–20 mA	12/24 V \cdots
	Pressure/vacuum switches	
	Transmitters 0–10 V	24 V \cdots
Voltage limits	Transmitters 4–20 mA	8–33 V \cdots
	Pressure/vacuum switches	
	Transmitters 0–10 V	11.4–33 V \cdots
Current consumption	Pressure/vacuum switches	< 4 mA
	Transmitters	< 20 mA
Protective treatment		Standard version "TC"
Ambient air temperature	For operation	–15 to +85 °C (5 to 185 °F)
	For storage	–40 to +85 °C (–40 to 185 °F)
Fluids or products controlled		Hydraulic oils, air, fresh water, sea water, corrosive fluids from –15 to +125 °C (5 to 257 °F)
Component materials in contact with fluid		Ceramic Al ₂ O ₃ , stainless steel type AISI 303, Viton® FPM, PPS (Leakage protection for P > 40 bar)
Operating position		All positions
Vibration resistance		20 gn (9–2000 Hz) conforming to IEC 60068-2-6
Shock resistance		25 gn (half sine wave 11 ms) conforming to IEC 60068-2-27
Resistance to electromagnetic interference	Electrostatic discharges	Standard EN 61000-4-2, 15 kV in air, 8 kV on contact
	Radiated electromagnetic fields	Standard EN 61000-4-3, 200 V/m, 80–1000 MHz
	Fast transients	Standard EN 61000-4-4, 4 kV
	Surges	Standard EN 61000-4-5, 500 V 12 Ω , 1 kV 42 Ω . Surges > 30–50 ms may damage the device.
	Conducted disturbances, induced by radio frequency fields	Standard EN 61000-4-6, 30 V 0.15–80 MHz
	Magnetic fields	Standard EN 61000-4-8, 30 A/m, 50 Hz
Electrical protection		Protected against reverse polarity and load short-circuit
Rated impulse withstand voltage		0.5 kV
Degree of protection		IP66, IP67 conforming to IEC/EN 60529, NEMA 4
Output response time		< 2 ms
Repeat accuracy		\pm 0.1% of the measuring range
Precision	Transmitters	Combined sum of linearity, hysteresis, and repeat accuracy \pm < 0.3% of the measuring range
		Setting tolerance of zero point and measuring range limit \pm < 0.3% of the measuring range
Drift	Pressure/vacuum switches	Setting accuracy \pm < 1% of the measuring range
	Zero point	\pm < 0.015% of the measuring range/°C
	Sensitivity	\pm < 0.015% of the measuring range/°C
Service life	In millions of operating cycles	> 10
Fluid connection		1/4" NPT male conforming to ISO 7
Electrical connection		M12 connector or Phoenix Contact QUICKON type integrated connection.

Units with analog output

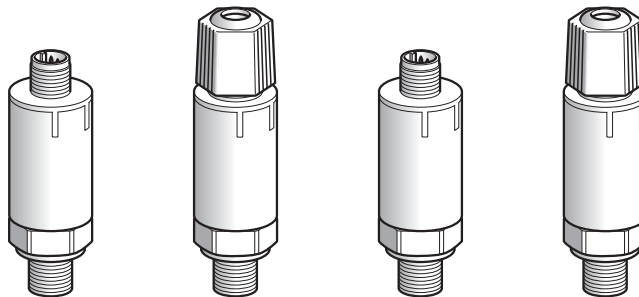

Pressure range (1)	–1 to 0 bar (–14.5 to 0 psi)		0 to 1 bar (0 to 14.5 psi)	
Type of electrical connection (2)	M12	Integrated quick connection	M12	Integrated quick connection

Catalog Numbers

Pressure transmitters, 4–20 mA					
Sold in packs of:	1	XMLGM01D23	—	XMLG001D23	—
	bulk (3)	XMLGM01D23TQ	XMLGM01Q23TQ	XMLG001D23TQ	XMLG001Q23TQ
Pressure transmitters, 0–10 V					
Sold in packs of:	1	XMLGM01D73	—	XMLG001D73	—
	bulk (3)	XMLGM01D73TQ	XMLGM01Q73TQ	XMLG001D73TQ	XMLG001Q73TQ
Fluid connection (4)	1/4" NPT male				
Weight, g (oz)	95 (3.35)	95 (3.35)	95 (3.35)	95 (3.35)	

Additional specifications not shown under general specifications (page 23)

Rated supply voltage	12/24 V \pm			
Voltage limits	8–33 V \pm			
Analog output	4–20 mA, 2-wire; or 0–10 V, 3-wire			
Current consumption	< 20 mA			
Maximum permissible accidental pressure	2.7 bar (39.1 psi)		2.7 bar (39.1 psi)	
Destructive pressure	3 bar (43.5 psi)		3 bar (43.5 psi)	
Electrical connection	By connector	XMLG●●●D●3: M12, 3-pin male. For suitable female connectors, including pre-wired versions, see page 32		
	Integrated	XMLG●●●Q●3: integrated connection, Phoenix Contact QUICKON type		

(1) For other pressure ranges, consult the Sensor Competency Center at 1-800-435-2121.

(2) For other connections (such as AMP connector or cable), consult the Sensor Competency Center at 1-800-435-2121.

(3) Sold in lots of 25, with a minimum order of 50 pcs.

(4) For other fluid connections (such as G 1/4 A BSP male or 1/4" NPTF female), refer to "Interpretation of the Catalog Number" on page 22, or consult the Sensor Competency Center at 1-800-435-2121. Component materials of units in contact with the fluid: see page 23.

Output curves

XMLGM01●23

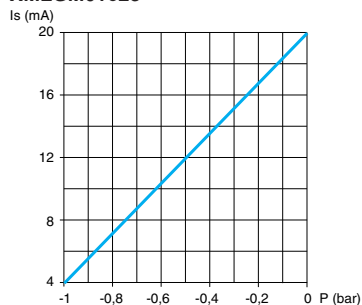

XMLG001●23

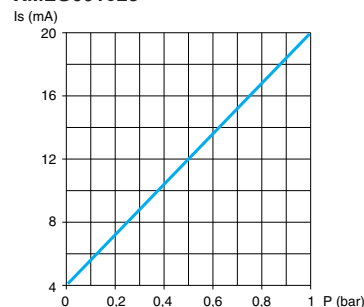

Units with analog output

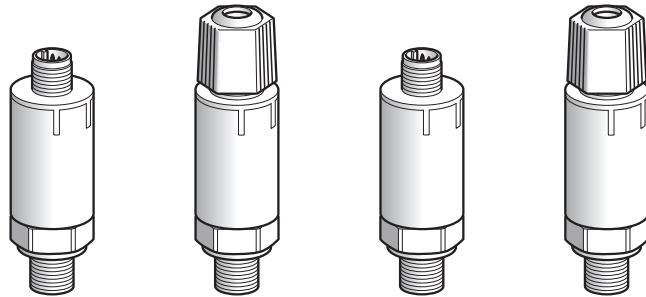

Pressure range (1)	0–10 bar (0–145 psi)		0–25 bar (0–362.5 psi)	
Type of electrical connection (2)	M12	Integrated quick connection	M12	Integrated quick connection

Catalog Numbers

Pressure transmitters, 4–20 mA

Sold in packs of:	1	XMLG010D23	—	XMLG025D23	—
	bulk (3)	XMLG010D23TQ	XMLG010Q23TQ	XMLG025D23TQ	XMLG025Q23TQ

Pressure transmitters, 0–10 V

Sold in packs of:	1	XMLG010D73	—	XMLG075D23	—
	bulk (3)	XMLG010D73TQ	XMLG010Q73TQ	XMLG075D23TQ	XMLG075Q23TQ

Fluid connection (4)	1/4" NPT male			
Weight, g (oz)	95 (3.35)	95 (3.35)	95 (3.35)	95 (3.35)

Additional specifications not shown under general specifications (page 23)

Rated supply voltage	12/24 V---			
Voltage limits	8–33 V---			
Analog output	4–20 mA, 2-wire; or 0–10 V, 3-wire			
Current consumption	< 20 mA			
Maximum permissible accidental pressure	22 bar (319 psi)		56 bar (812 psi)	
Destructive pressure	25 bar (362.5 psi)		62.5 bar (906.2 psi)	
Electrical connection	By connector	XMLG●●●D●3: M12, 3-pin male. For suitable female connectors, including pre-wired versions, see page 32		
	Integrated	XMLG●●●Q●3: integrated connection, Phoenix Contact QUICKON type		

(1) For other pressure ranges, consult the Sensor Competency Center at 1-800-435-2121.

(2) For other connections (such as AMP connector or cable), consult the Sensor Competency Center at 1-800-435-2121.

(3) Sold in lots of 25, with a minimum order of 50 pcs.

(4) For other fluid connections (such as G 1/4 A BSP male or 1/4" NPTF female), refer to "Interpretation of the Catalog Number" on page 22, or consult the Sensor Competency Center at 1-800-435-2121. Component materials of units in contact with the fluid: see page 23.

Output curves

XMLG010●23

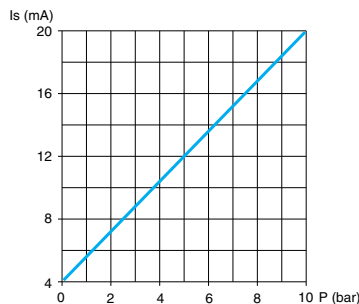

XMLG025●23

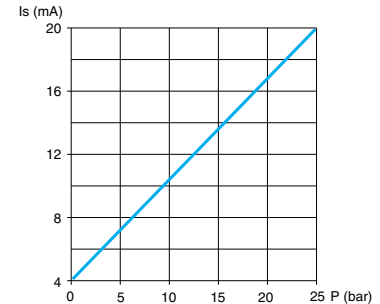

Units with analog output

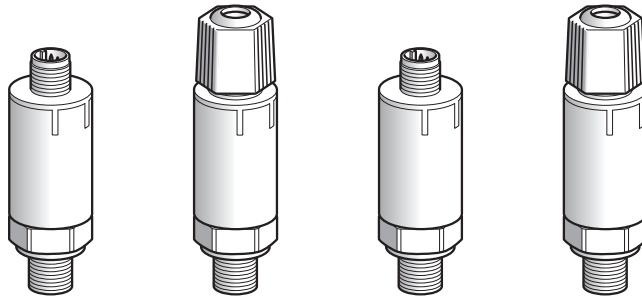

Pressure range (1)	0–100 bar (0–1450 psi)		0–250 bar (0–3625 psi)	
Type of electrical connection (2)	M12	Integrated quick connection	M12	Integrated quick connection

Catalog Numbers

Pressure transmitters, 4–20 mA					
Sold in packs of:	1	XMLG100D23	—	XMLG250D23	—
	bulk (3)	XMLG100D23TQ	XMLG100Q23TQ	XMLG250D23TQ	XMLG250Q23TQ
Pressure transmitters, 0–10 V					
Sold in packs of:	1	XMLG100D73	—	XMLG250D73	—
	bulk (3)	XMLG100D73TQ	XMLG100Q73TQ	XMLG250D73TQ	XMLG250Q73TQ
Fluid connection (4)	1/4" NPT male				
Weight, g (oz)	95 (3.35)	95 (3.35)	95 (3.35)	95 (3.35)	

Additional specifications not shown under general specifications (page 23)

Rated supply voltage	12/24 V \pm			
Voltage limits	8–33 V \pm			
Analog output	4–20 mA, 2-wire; or 0–10 V, 3-wire			
Current consumption	< 20 mA			
Maximum permissible accidental pressure	225 bar (3262.5 psi)		560 bar (8120 psi)	
Destructive pressure	250 bar (3625 psi)		625 bar (9062.5 psi)	
Electrical connection	By connector	XMLG●●●D●3: M12, 3-pin male. For suitable female connectors, including pre-wired versions, see page 32		
	Integrated	XMLG●●●Q●3: integrated connection, Phoenix Contact QUICKON type		

(1) For other pressure ranges, consult the Sensor Competency Center at 1-800-435-2121.
 (2) For other connections (such as AMP connector or cable), consult the Sensor Competency Center at 1-800-435-2121.
 (3) Sold in lots of 25, with a minimum order of 50 pcs.
 (4) For other fluid connections (such as G 1/4 A BSP male or 1/4" NPTF female), refer to "Interpretation of the Catalog Number" on page 22, or consult the Sensor Competency Center at 1-800-435-2121. Component materials of units in contact with the fluid: see page 23.

Output curves

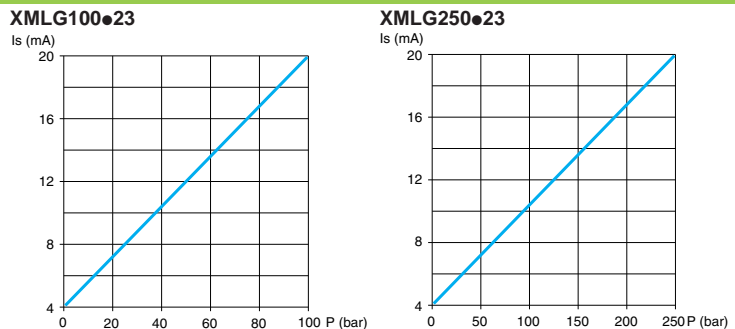

Units with analog output

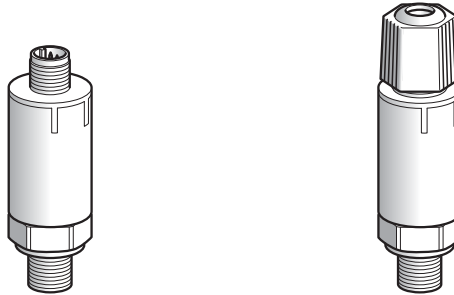

Pressure range (1)	0–400 bar (0–5800 psi)	
Type of electrical connection (2)	M12	Integrated quick connection

Catalog Numbers

Pressure transmitters, 4–20 mA			
Sold in packs of:	1	XMLG400D23	—
	bulk (3)	XMLG400D23TQ	XMLG400Q23TQ
Pressure transmitters, 0–10 V			
Sold in packs of:	1	XMLG400D73	—
	bulk (3)	XMLG400D73TQ	XMLG400Q73TQ
Fluid connection (4)	1/4" NPT male		
Weight, g (oz)	95 (3.35)	95 (3.35)	

Additional specifications not shown under general specifications (page 23)

Rated supply voltage	12/24 V---	
Voltage limits	8–33 V---	
Analog output	4–20 mA, 2-wire; or 0–10 V, 3-wire	
Current consumption	< 20 mA	
Maximum permissible accidental pressure	800 bar (11,600 psi)	
Destructive pressure	900 bar (13,050 psi)	
Electrical connection	By connector	XMLG●●●D●3: M12, 3-pin male. For suitable female connectors, including pre-wired versions, see page 32
	Integrated	XMLG●●●Q●3: integrated connection, Phoenix Contact QUICKON type

(1) For other pressure ranges, consult the Sensor Competency Center at 1-800-435-2121.

(2) For other connections (such as AMP connector or cable), consult the Sensor Competency Center at 1-800-435-2121. Component materials of units in contact with the fluid: see page 23.

(3) Sold in lots of 25, with a minimum order of 50 pcs.

(4) For other fluid connections (such as G 1/4 A BSP male or 1/4" NPTF female), refer to "Interpretation of the Catalog Number" on page 22, or consult the Sensor Competency Center at 1-800-435-2121. Component materials of units in contact with the fluid: see page 23.

Output curves

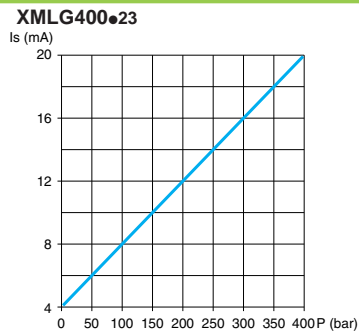

Units with solid-state output (1)

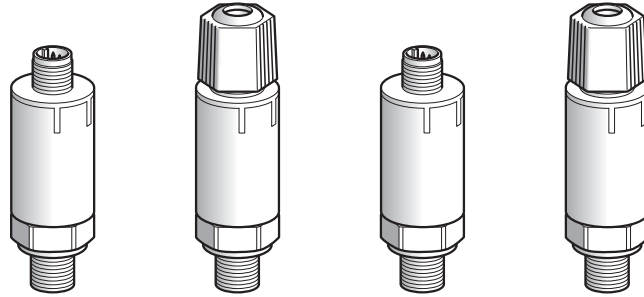

Adjustable range of switching point (PH) Rising pressure (2) (7)	–0.08 to –1 bar (–1.16 to –14.5 psi)		0.08 to 1 bar (1.16 to 14.5 psi)	
Type of electrical connection (3)	M12	Integrated quick connection	M12	Integrated quick connection

Catalog Numbers

Only sold in bulk packs (4)				
NPN output (N.C.)	XMLGM01D33TQ	XMLGM01Q33TQ	XMLG001D33TQ	XMLG001Q33TQ
PNP output (N.C.)	XMLGM01D43TQ	XMLGM01Q43TQ	XMLG001D43TQ	XMLG001Q43TQ

Fluid connection (5)	1/4" NPT male			
Weight, g (oz)	95 (3.35)	95 (3.35)	95 (3.35)	95 (3.35)

Additional specifications not shown under general specifications (page 23)

Switching thresholds (6)	Factory set		
Possible differential	Min. at low setting	0.03 bar (0.44 psi)	0.03 bar (0.44 psi)
	Min. at high setting	0.03 bar (0.44 psi)	0.03 bar (0.44 psi)
	Max. at high setting	0.95 bar (13.77 psi)	0.95 bar (13.77 psi)
Maximum permissible accidental pressure	2.7 bar (39.1 psi)		2.7 bar (39.1 psi)
Destructive pressure	3 bar (43.5 psi)		3 bar (43.5 psi)
Rated supply voltage	12/24 V $\overline{--}$		
Voltage limits	8–33 V $\overline{--}$		
Output	Solid-state, NPN or PNP, NC		
Switching capacity	150 mA		
Current consumption	< 4 mA		
Electrical connection	By connector	XMLG●●●D●3: M12, 3-pin male. For suitable female connectors, including pre-wired versions, see page 32	
	Integrated	XMLG●●●Q●3: integrated connection, Phoenix Contact QUICKON type	

(1) For other types of output (such as normally open PNP or NPN), consult the Sensor Competency Center at 1-800-435-2121.
 (2) For other pressure ranges, consult the Sensor Competency Center at 1-800-435-2121.
 (3) For other connections (such as cable and AMP connector), consult the Sensor Competency Center at 1-800-435-2121.
 (4) Sold in lots of 25, with a minimum order of 50 pcs.
 (5) For other fluid connections (such as G 1/4 A BSP male or 1/4" NPTF female), refer to "Interpretation of the Catalog Number" on page 22, or consult the Sensor Competency Center at 1-800-435-2121. Component materials of units in contact with the fluid: see page 23.
 (6) **Must state the switching threshold settings when ordering.**
 (7) For vacuum switches (size –1 bar): adjustable range of switching point (PB) on falling pressure.

Operating curves

XMLGM01●●1

XMLG001●●1

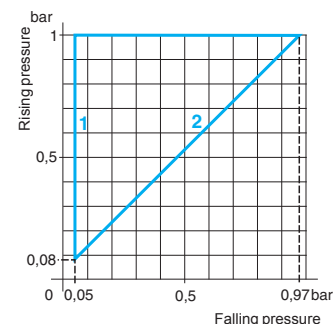
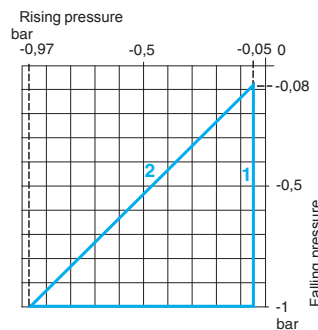

1 Maximum differential
2 Minimum differential

Units with solid-state output (1)

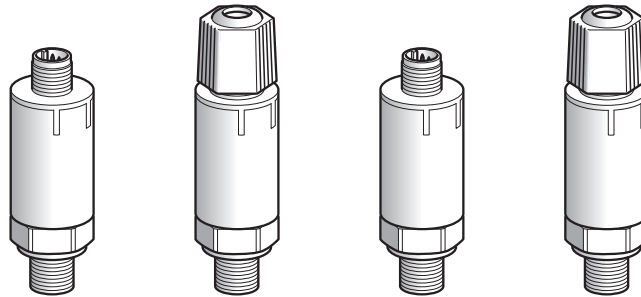

Adjustable range of switching point (PH) Rising pressure (2)	0.8–10 bar (11.6–145 psi)		2–25 bar (29–362.5 psi)	
Type of electrical connection (3)	M12	Integrated quick connection	M12	Integrated quick connection

Catalog Numbers

Only sold in bulk packs (4)					
	NPN output (N.C.)	XMLG010D33TQ	XMLG010Q33TQ	XMLG025D33TQ	XMLG025Q33TQ
	PNP output (N.C.)	XMLG010D43TQ	XMLG010Q43TQ	XMLG025D43TQ	XMLG025Q43TQ

Fluid connection (5)	1/4" NPT male			
Weight, g (oz)	95 (3.35)	95 (3.35)	95 (3.35)	95 (3.35)

Additional specifications not shown under general specifications (page 23)

Switching thresholds (6)	Factory set			
Possible differential	Min. at low setting	0.3 bar (4.4 psi)	0.75 bar (10.9 psi)	
	Min. at high setting	0.3 bar (4.4 psi)	0.75 bar (10.9 psi)	
	Max. at high setting	9.5 bar (137.75 psi)	23.8 bar (345.1 psi)	
Maximum permissible accidental pressure		22 bar (319 psi)	56 bar (812 psi)	
Destructive pressure		25 bar (362.5 psi)	62.5 bar (906.2 psi)	
Rated supply voltage	12/24 V $\overline{--}$			
Voltage limits	8–33 V $\overline{--}$			
Output	Solid-state, NPN or PNP, NC			
Switching capacity	150 mA			
Current consumption	< 4 mA			
Electrical connection	By connector	XMLG●●●D●3: M12, 3-pin male. For suitable female connectors, including pre-wired versions, see page 32		
	Integrated	XMLG●●●Q●3: integrated connection, Phoenix Contact QUICKON type		

(1) For other types of output (such as normally open PNP or NPN), consult the Sensor Competency Center at 1-800-435-2121.

(2) For other pressure ranges, consult the Sensor Competency Center at 1-800-435-2121.

(3) For other connections (such as AMP connector or cable), consult the Sensor Competency Center at 1-800-435-2121.

(4) Sold in lots of 25, with a minimum order of 50 pcs.

(5) For other fluid connections (such as G 1/4 A BSP male or 1/4" NPTF female), refer to "Interpretation of the Catalog Number" on page 22, or consult the Sensor Competency Center at 1-800-435-2121. Component materials of units in contact with the fluid: see page 23.

(6) Must state the switching threshold settings when ordering.

Operating curves

XMLG010●●1

XMLG025●●1

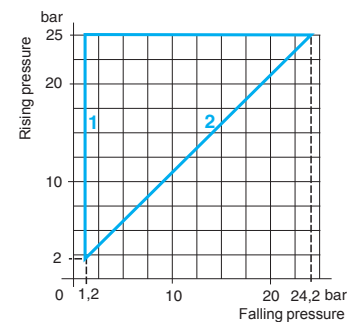
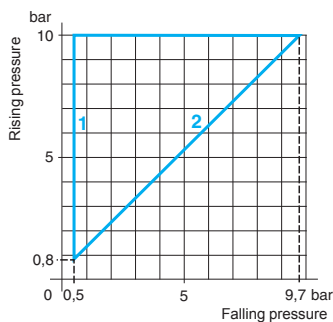

1 Maximum differential
2 Minimum differential

Units with solid-state output (1)

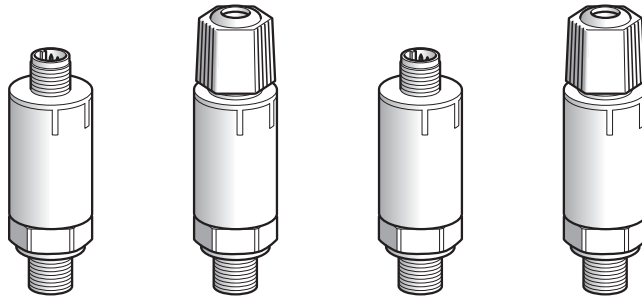

Adjustable range of switching point (PH) Rising pressure (2)	8–100 bar (11.6–1450 psi)		20–250 bar (29–3625 psi)	
Type of electrical connection (3)	M12	Integrated quick connection	M12	Integrated quick connection

Catalog Numbers

Only sold in bulk packs (4)

NPN output (N.C.)	XMLG100D33TQ	XMLG100Q33TQ	XMLG250D33TQ	XMLG250Q33TQ
PNP output (N.C.)	XMLG100D43TQ	XMLG100Q43TQ	XMLG250D43TQ	XMLG250Q43TQ
Fluid connection (5)	1/4" NPT male			
Weight, g (oz)	95 (3.35)	95 (3.35)	95 (3.35)	95 (3.35)

Additional specifications not shown under general specifications (page 23)

Switching thresholds (6)	Factory set			
Possible differential	Min. at low setting	3 bar (43.5 psi)	7.5 bar (108.8 psi)	
	Min. at high setting	3 bar (43.5 psi)	7.5 bar (108.8 psi)	
	Max. at high setting	95 bar (1377.5 psi)	237.5 bar (3443.7 psi)	
Maximum permissible accidental pressure	225 bar (3262.5 psi)		560 bar (8120 psi)	
Destructive pressure	250 bar (3625 psi)		625 bar (9062.5 psi)	
Rated supply voltage	12/24 V---			
Voltage limits	8–33 V---			
Output	Solid-state, NPN or PNP, NC			
Switching capacity	150 mA			
Current consumption	< 4 mA			
Electrical connection	By connector	XMLG●●●D●3: M12, 3-pin male. For suitable female connectors, including pre-wired versions, see page 32		
	Integrated	XMLG●●●Q●3: integrated connection, Phoenix Contact QUICKON type		

- (1) For other types of output (such as normally open PNP or NPN), consult the Sensor Competency Center at 1-800-435-2121.
 (2) For other pressure ranges, consult the Sensor Competency Center at 1-800-435-2121.
 (3) For other connections (such as AMP connector or cable), consult the Sensor Competency Center at 1-800-435-2121.
 (4) Sold in lots of 25, with a minimum order of 50 pcs.
 (5) For other fluid connections (such as G 1/4 A BSP male or 1/4" NPTF female), refer to "Interpretation of the Catalog Number" on page 22, or consult the Sensor Competency Center at 1-800-435-2121. Component materials of units in contact with the fluid: see page 23.
 (6) Must state the switching threshold settings when ordering.

Operating curves

XMLG100●●1TQ

XMLG250●●1TQ

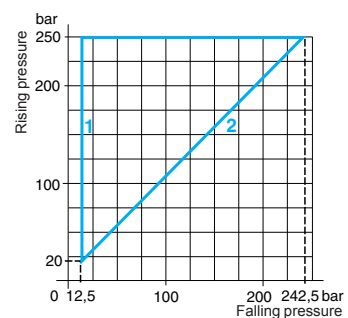
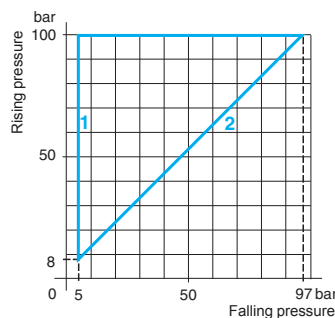

- 1 Maximum differential
2 Minimum differential

Units with solid-state output (1)

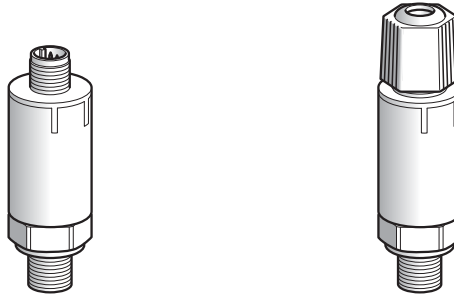

Adjustable range of switching point (PH) Rising pressure (2)	32–400 bar (464–5800 psi)	
Type of electrical connection (3)	M12	Integrated quick connection

Catalog Numbers

Only sold in bulk packs (4)		
NPN output (N.C.)	XMLG400D33TQ	XMLG400Q33TQ
PNP output (N.C.)	XMLG400D43TQ	XMLG400Q43TQ
Fluid connection (5)	1/4" NPT male	
Weight, g (oz)	95 (3.35)	95 (3.35)

Additional specifications not shown under general specifications (page 23)

Switching thresholds (6)	Factory set	
Possible differential	Min. at low setting	12 bar (174 psi)
	Min. at high setting	12 bar (174 psi)
	Max. at high setting	380 bar (5510 psi)
Maximum permissible accidental pressure	800 bar (11,600 psi)	
Destructive pressure	900 bar (13,050 psi)	
Rated supply voltage	12/24 V---	
Voltage limits	8–33 V---	
Output	Solid-state, NPN or PNP, NC	
Switching capacity	150 mA	
Current consumption	< 4 mA	
Electrical connection	By connector	XMLG●●●D●3 : M12, 3-pin male. For suitable female connectors, including pre-wired versions, see page 32
	Integrated	XMLG●●●Q●3 : integrated connection, Phoenix Contact QUICKON type

(1) For other types of output (such as normally open PNP or NPN), consult the Sensor Competency Center at 1-800-435-2121.

(2) For other pressure ranges, consult the Sensor Competency Center at 1-800-435-2121.

(3) For other connections (such as AMP connector or cable), consult the Sensor Competency Center at 1-800-435-2121.

(4) Sold in lots of 25, with a minimum order of 50 pcs.

(5) For other fluid connections (such as G 1/4 A BSP male or 1/4" NPTF female), refer to "Interpretation of the Catalog Number" on page 22, or consult the Sensor Competency Center at 1-800-435-2121. Component materials of units in contact with the fluid: see page 23.

(6) Must state the switching threshold settings when ordering.

Operating curve

XMLG400●●1TQ

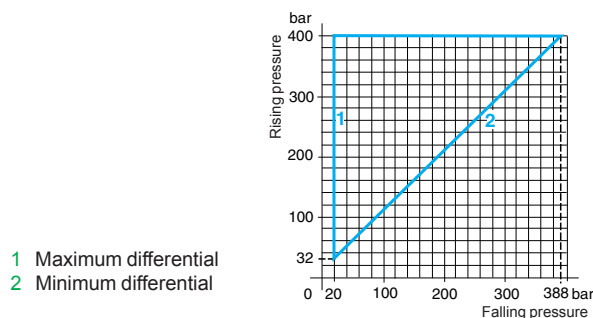

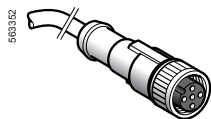

XZCP1141L●

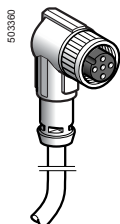

XZCP1241L●



XZCC12FDM40V



XZCC12FCM40B

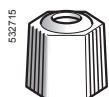

XMLGZ001

Connection accessories

Description		Length of cable m (ft)	Catalog number	Weight g (oz)
M12 straight, female connector (1)		—	XZCC12FDM40V	15 (0.53)
M12 female connector, metal clamping ring	Straight	—	XZCC12FDM40B	20 (0.71)
Connector with screw terminal connections	90°	—	XZCC12FCM40B	20 (0.71)
Pre-wired M12 female connectors	Straight (Black PUR)	2 (6.6)	XZCP1141L2	90 (3.17)
		5 (16.4)	XZCP1141L5	190 (6.70)
		10 (32.8)	XZCP1141L10	370 (13.05)
	Straight (Yellow PVC)	2 (6.6)	XSZCD101Y	90 (3.17)
		5 (16.4)	XSZCD102Y	190 (6.70)
		10 (32.8)	XSZCD103Y	370 (13.05)
90°		2 (6.6)	XZCP1241L2	90 (3.17)
		5 (16.4)	XZCP1241L5	0.190 (6.70)
		10 (32.8)	XZCP1241L10	370 (13.05)

Replacement part

Description	Sold in lots of	Unit catalog number	Weight g (oz)
Quick connection Phoenix Contact QUICKON type	10	XMLGZ001	25 (0.88)

(1) Connector incorporating IDCs (insulation displacement connectors) for quick, direct, in-line connection to cable without a screwdriver or soldering iron.

Dimensions, mm (in.)

XMLG●●●D●●, M12 x 1 connection

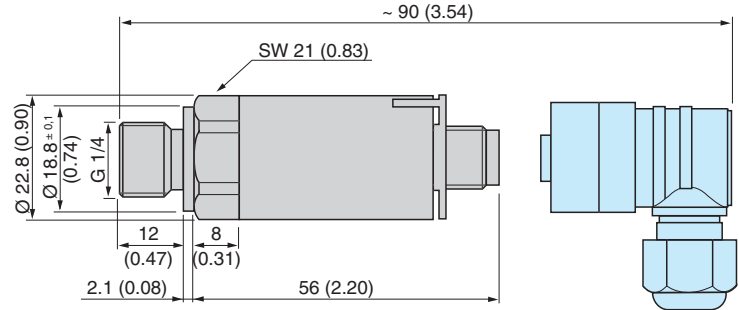

XMLG●●●Q●●, integrated quick connection

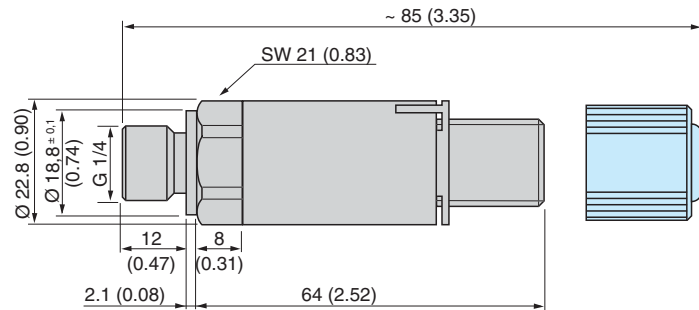

Connector wiring (pressure sensor connector pin view)

Electronic pressure switches

M12

3-wire (PNP)

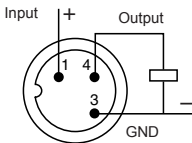

Integrated quick connection

3-wire (PNP)

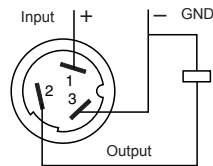

3-wire (NPN)

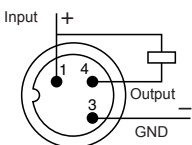

3-wire (NPN)

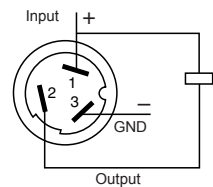

Pressure transmitters

M12

2-wire (4–20 mA)

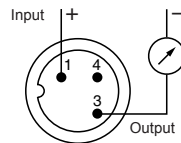

Integrated quick connection

2-wire (4–20 mA)

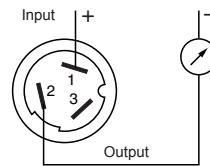

3-wire (0–10 V)

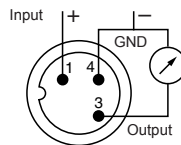

3-wire (0–10 V)

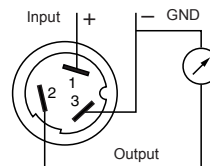

OsiSense® XML

Electronic pressure sensors

XMLF pressure sensors

For control circuits

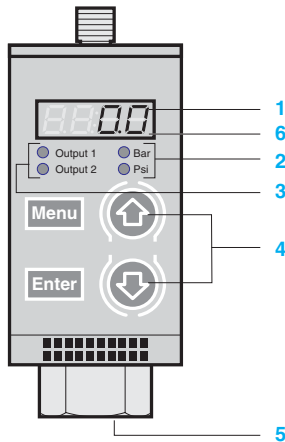

Introduction

XMLF electronic pressure sensors are used for pressure control of hydraulic oils, fresh water, sea water, air, and corrosive fluids, between –1 and 600 bar (–14.5 and 8700 psi).

Simplifying setup

XMLF electronic pressure sensors are characterized by their ceramic pressure measuring cell.

- 1 Large 4-digit display indicating the programming codes, parameter values, or measured pressure.
- 2 LED indicating the selected unit of measurement (bar or psi).
- 3 LED indicating the status of the pressure switch output(s).
- 4 Ergonomic keys for configuring the product via the pull-down menu.
- 5 Excellent resistance to overpressure.
- 6 Memorization and ability to display the pressure peaks within the installation.

Three menus enable the user to do the following:

- configure (PROG menu) the various functions of the unit (access to all the parameters of the product)
- perform (USER menu) diagnostic operations and, for pressure switches, to set the switching point pressure values
- read (READ menu) all the configuration details, together with the values set in the PROG and USER menus

Functions

Pressure transmitters **XMLF●●●D2●1●** have a 4–20 mA or 0–10 V analog output. In addition to having a manual diagnostic function (see below), they also incorporate a remote diagnostic function: a digital input connected to a PLC, for example, enables remote activation of the sensor's test function. When the sensor is operating correctly, the analog output must, when testing, be close to 50% of the sensor size (12 mA or 5 V).

Universal sensors **XMLF●●●D2●2●** are pressure switches with an adjustable differential, for regulation between 2 thresholds, featuring a solid-state output (configurable for NPN or PNP, and for NO or NC), and a 4–20 mA or 0–10 V analog output. They incorporate the manual diagnostic function (see below).

Pressure switches **XMLF●●●D2●3●** are dual stage switches, with adjustable differential for each threshold, featuring 2 solid-state outputs (configurable for NPN or PNP, and for NO or NC). They incorporate the manual diagnostic function (see below).

Pressure switches **XMLF●●●E2●4●** for AC control are switches with adjustable differential, for regulation between 2 thresholds, featuring a 2.5 A, AC relay output (configurable for NO or NC). They incorporate the manual diagnostic function (see below).

XMLF sensors feature:

Various configurable functions

For the display:

- pressure unit of measurement (bar or psi),
- response time (slow: display refreshes in increments of 1% of the unit size; normal: display refreshes in increments of 0.5% of the unit size; or fast: display refreshes every 10 ms).

For the analog output:

- response time (adjustable from 5 to 500 ms, in increments of 1 ms),
- maximum pressure of the output curve (adjustable from 75 to 125% of the unit size).

For each solid-state output:

- PNP or NPN logic,
- NO or NC output,
- time delay on trip and on reset (adjustable from 0 to 50 s, in increments of 1 s),
- response time (adjustable from 5 to 500 ms, in increments of 1 ms).

For the AC relay output models:

- NO or NC contact,
- time delay on trip and on reset (adjustable from 0 to 50 s, in increments of 1 s),
- response time (adjustable from 5 to 500 ms, in increments of 1 ms).

Manual diagnostic function enabling:

- checking the correct operation of sensor
- reading the value of the maximum pressure peak that has occurred since the last reset to zero, as well as deleting this value for a fresh reset.

Features of XMLF pressure sensors

XMLF pressure sensors (see page 34) feature numerous possibilities for configuring the display (response time, choice of bar or psi units), the analog output signal operation (maximum signal output adjustable between 75% and 125% of the unit size), the solid-state output operation (PNP or NPN, NO or NC, time delay on opening or on closing, response time), and the status signaling (see below). A diagnostic function enables verification at any time of the sensor's correct operation (see below), and also provides information regarding pressure peak values.

Self-test function (calibration shunt)

XMLF pressure sensors incorporate a diagnostic function that can be used at any time to check the correct operation of the unit. An internal system enables automatic monitoring of the sensor circuits, including the ceramic pressure measuring load cell.

For all models, this function is manually activated and the result of the test is indicated on the display (DONE or ERR).

For pressure transmitters, this function can also be remotely activated via a digital input connected to a PLC, which enables automatic verification without operator intervention. In this case, the self-test also generates an analog output signal equivalent to 50% of the sensor's size (12 mA or 5 V), which in turn can be verified by the PLC.

The unit should be replaced if the difference between the signal transmitted and the standard theoretical value is too great.

Operational status signaling

XMLF pressure and vacuum switches feature status LED indicators for the digital outputs. Indication can be configured for two modes:

- **Hysteresis mode:** the indicator illuminates when the output is activated (output off for NC configuration or output on for NO configuration).
- **Window mode:** the indicator illuminates when the measured pressure is between the high and low setpoint values.

Selection of switch size

Size is selected according to the maximum pressure of the system to be controlled.

Adherence to pressure

Select a size where the nominal pressure is higher than the maximum pressure of the controlled system.

Precision, repeat accuracy

The precision and repeat accuracy are expressed as a percentage of the measuring range. Better detection is achieved when the sensor size is close to that of the maximum pressure of the controlled system. As general rule, avoid working toward the bottom limit of the measuring range.

Minimum differential of a pressure or vacuum switch

The minimum differential for each switch size is a percentage of its operating range: 2% for XMLE, and 3% for XMLF.

Selection example for a pressure switch

Maximum pressure of the system = 11 bar

High Setpoint (PH)= 7 bar

Low Setpoint (PB)= 6 bar

2 alternatives:

XML●010●●●●● (10 bar) or

XML●025●●●●● (25 bar)

Advantages:

XML●010●●●●●: maximum repeat accuracy and precision

XML●025●●●●●: withstand of overpressure.

Environmental specifications		
Conformity to standards		CE, IEC/EN 60947-1, IEC/EN 60947-5-1, EN 50081, EN 50082, EN 61000-6-2, EN 61000-4-2/3/4/5/6/8/11
Product certifications		UL, CSA
Protective treatment		Standard version "TC"
Ambient air temperature	For operation	DC models: -25 to +80 °C (-13 to 176 °F) AC models: -25 to +75 °C (-13 to 167 °F)
Fluids or products controlled		Hydraulic oils, air, fresh water, sea water, corrosive fluids from -15 to +80 °C (5 to 176 °F)
Component materials in contact with fluid		Stainless steel fluid entry type AISI 303, Viton [®] gasket Ceramic pressure measuring cell
Operating position		All positions
Vibration resistance		5 gn (25–200 Hz) and 35 gn (60–2000 Hz), conforming to IEC 68-2-6
Shock resistance		50 gn, conforming to IEC 68-2-27
Electrical protection		Protected against reverse polarity, short-circuit, overload, and miswiring
Resistance to electromagnetic interference	Electrostatic discharges	Standard EN 61000-4-2 contact 4kV, air 8 kV
	Radiated electromagnetic fields	Standard EN 61000-4-3 10 V/m
	Fast transients	Standard EN 61000-4-4 2 kV
	Surges	Standard EN 61000-4-5 (AC) 1 kV, (DC) 0.5 kV
	Conducted disturbances, induced by radio frequency fields	Standard EN 61000-4-6 10 V
Degree of protection		IP67 conforming to IEC/EN 60529, NEMA 4/6/12/13
Operating rate		< 50 Hz
Output response time		Adjustable from 5 to 500 ms, in increments of 1 ms
Service life	In millions of operating cycles	> 10
Drift	Of the zero point	< ± 0.1% of the measuring range/°C
	Of the sensitivity	< ± 0.03% of the measuring range/°C
Precision	Analog output	≤ 0.6% of the measuring range, output offset < 200 mV
	Digital output	≤ 0.6% of the measuring range
Repeat accuracy		≤ 0.5% of the measuring range
Display response time		Adjustable; 3 options: - slow (1% of the unit size), - normal (0.5% of the unit size), or - fast (refreshed every 10 ms)
Fluid connection		G 1/4 A (BSP female) conforming to NF E 03-004 and ISO 7, 1/4" NPT, or SAE 7/16-20UNF female, depending on the model
Electrical connection		M12 connector or SAE 7/8-16UN connector, depending on the model

OsiSense® XML
 Electronic pressure sensors
 XMLF pressure sensors
 For control circuits

Interpretation of the Catalog Number—XMLF

XMLF		100		D	2	02	6
Configurable	Rated pressure			Electrical Connection	N/A	Output	Fluid Connection
	Code	psi	bar				
	M01	-14.5 to 0	-1 to 0	D: M12 DC only E: 7/8-16 UN2A AC only		01: DC Analog 4–20 mA, shunt calibration 02: DC Analog 4–20 mA, digital single stage 11: DC Analog 0–10 V, shunt calibration 12: DC Analog 0–10 V, digital single stage 03: DC digital dual stage 04: AC Relay 120 V	5: 1/4" BSP female 6: 1/4" NPTF female 9: SAE 7/16-20 UNF female
	002	0 to 36.25	0 to 2.5				
	010	0 to 145	0 to 10				
	016	0 to 232	0 to 16				
	025	0 to 362.5	0 to 25				
	040	0 to 580	0 to 40				
	070	0 to 1015	0 to 70				
	100	0 to 1450	0 to 100				
	160	0 to 2320	0 to 160				
	250	0 to 3625	0 to 250				
	400	0 to 5800	0 to 400				
	600	0 to 8700	0 to 600				

NOTE: Use this table only to interpret the catalog number. Some combinations are not available.

OsiSense® XML

Electronic pressure sensors
XMLF pressure sensors
Size: -1 bar (-14.5 psi)

Type	Pressure transmitters	Universal sensors with adjustable differential. Solid-state and analog outputs
------	-----------------------	--

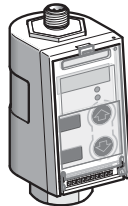

Adjustable range of switching point (PB) (Falling pressure)	—		-0.08 to -1 bar (-1.16 to -14.5 psi)	
Analog output	4-20 mA	0-10 V	4-20 mA	0-10 V

Catalog Numbers

Fluid connection (1)	1/4" BSP female	XMLFM01D2015	XMLFM01D2115	XMLFM01D2025	XMLFM01D2125
	1/4" NPT female	XMLFM01D2016	XMLFM01D2116	XMLFM01D2026	XMLFM01D2126
Weight, g (oz)	480 (16.93)				

Additional specifications not shown under general specifications (page 36)

Possible differential (add to PB to give PH)	Min. at low and high setting	—	0.03 bar (0.44 psi)
	Max. at low setting	—	0.95 bar (13.77 psi)
Maximum permissible accidental pressure	3 bar (43.5 psi)		
Destructive pressure	5 bar (72.5 psi)		
Rated supply voltage	24 V $\overline{--}$		
Voltage limits	17-33 V $\overline{--}$		
Current consumption	80 mA		
Output	—		
Time delay	—		
Switching capacity	—		
Analog output	4-20 mA or 0-10 V, depending on the model. Maximum signal level adjustable between -0.25 and 0.25 bar (-3.62 and 3.62 psi)		
Electrical connection	M12, 4-pin male connector. For suitable female connectors, including pre-wired versions, see page 64		

(1) Fluids controlled: hydraulic oils, fresh water, sea water, air, corrosive fluids, from -15 to +80 °C (5 to 176 °F).

Curves

Analog output curve	Vacuum sensor operating curves
---------------------	--------------------------------

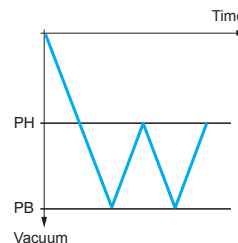
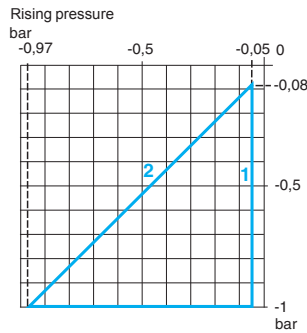
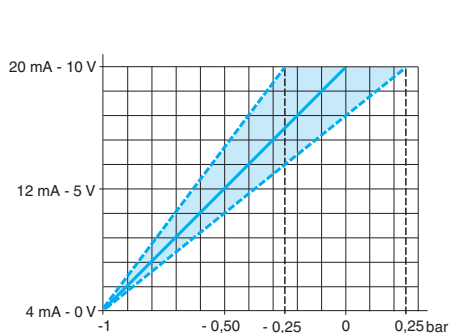

- 1 Maximum differential
- 2 Minimum differential

— Adjustable value

Type	Vacuum switches with adjustable differential and relay output	Dual stage adjustable vacuum switches with solid-state outputs
------	---	--

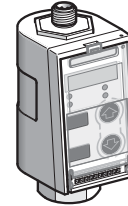
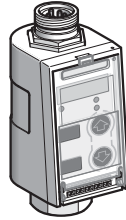

Adjustable range of switching point(s) (PB or PB1 and PB2) (Falling pressure) -0.08 to -1 bar (-1.16 to -14.5 psi)

Catalog Numbers

Fluid connection	1/4" BSP female	XMLFM01E2045	XMLFM01D2035
(1)	1/4" NPT female	XMLFM01E2046	XMLFM01D2036
Weight, g (oz)		590 (20.81)	480 (16.93)

Additional specifications not shown under general specifications (page 36)

Possible differential (add to: - PB to get PH - PB1 & PB2 to get PH1 & PH2)	Min. at low and high setting	0.03 bar (0.44 psi)	For each stage: min. at low and high setting: 0.03 bar (0.44 psi) max. at low setting: 0.95 bar (13.77 psi)
	Max. at low setting	0.95 bar (13.77 psi)	
Maximum permissible accidental pressure	3 bar (43.5 psi)		
Destructive pressure	5 bar (72.5 psi)		
Rated supply voltage	120 V~		24 V--
Voltage limits	102-132 V~		17-33 V--
Current consumption	32 mA		80 mA
Output	Relay		Programmable, NPN or PNP, and NO or NC
Time delay	Adjustable time delay on trip and on reset from 0 to 50 s, in increments of 1 s		
Switching capacity	2.5 A, AC-15, C300 (120 V / 1.5 A)		200 mA
Electrical connection	SAE 7/8-16UN, 5-pin male connector. For suitable female pre-wired connectors, see page 64		M12, 4-pin male connector. For suitable female connectors, including pre-wired versions, see page 64

(1) Fluids controlled: hydraulic oils, fresh water, sea water, air, corrosive fluids, from -15 to +80 °C (5 to 176 °F).

Vacuum switch operating curves

(Curve for each stage for dual stage vacuum switches) Vacuum switches with relay output Dual stage vacuum switches

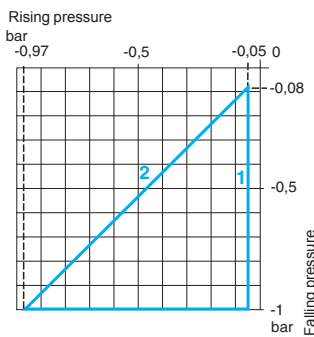

- 1 Maximum differential
- 2 Minimum differential

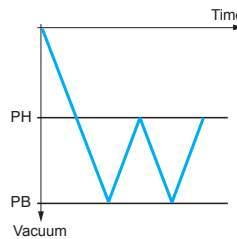

— Adjustable value

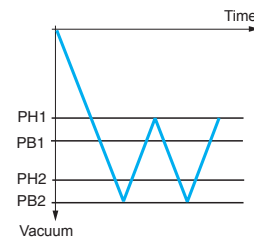

— Adjustable value

OsiSense® XML

Electronic pressure sensors
XMLF pressure sensors
Size: 1 bar (14.5 psi)

Type	Pressure transmitters	Universal sensors with adjustable differential. Solid-state and analog outputs (1)
------	-----------------------	--



Adjustable range of switching point (PH) (Rising pressure)	—		0.08–1 bar (1.16–14.5 psi)	
Analog output	4–20 mA	0–10 V	4–20 mA	0–10 V

Catalog Numbers

Fluid connection (2)	1/4" BSP female	XMLF001D2015	XMLF001D2115	XMLF001D2025	XMLF001D2125
	1/4" NPT female	XMLF001D2016	XMLF001D2116	XMLF001D2026	XMLF001D2126
Weight, g (oz)	480 (16.93)				

Additional specifications not shown under general specifications (page 36)

Possible differential (subtract from PH to get PB)	Min. at low and high setting	—	0.03 bar (0.44 psi)
	Max. at high setting	—	0.95 bar (13.77 psi)
Maximum permissible accidental pressure	4 bar (58 psi)		
Destructive pressure	6 bar (87 psi)		
Rated supply voltage	24 V $\overline{--}$		
Voltage limits	17–33 V $\overline{--}$		
Current consumption	80 mA		
Output	—		
Time delay	—		
Switching capacity	—		
Analog output	4–20 mA or 0–10 V, depending on the model. Maximum signal level adjustable between 0.75 and 1.25 bar (10.88 and 18.12 psi)		
Electrical connection	M12, 4-pin male connector. For suitable female connectors, including pre-wired versions, see page 64		

(1) Pressure sensors with adjustable differential for regulation between 2 thresholds. Solid-state and analog outputs.
(2) Fluids controlled: hydraulic oils, fresh water, sea water, air, corrosive fluids, from –15 to +80 °C (5 to 176 °F). Component materials of units in contact with the fluid: see page 36.

Curves

Analog output curve | Pressure sensor operating curves

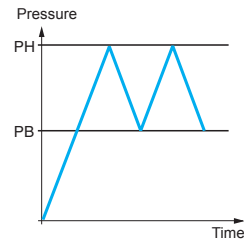
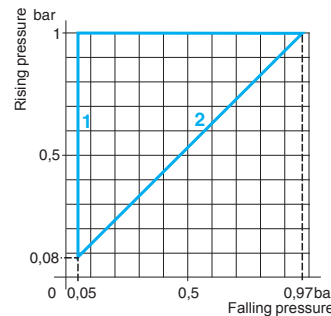
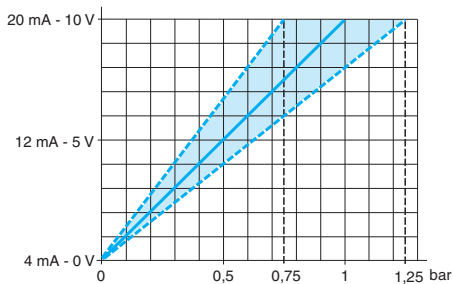

- 1 Maximum differential
- 2 Minimum differential

— Adjustable value

Type	Pressure switches with adjustable differential and relay output (1)	Dual stage adjustable pressure switches with solid-state outputs (2)
-------------	--	---

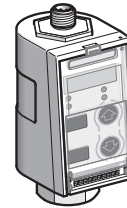
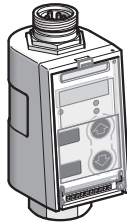

Adjustable range of switching point(s) (PH or PH1 and PH2) (Rising pressure)	0.08–1 bar (1.16–14.5 psi)
---	-----------------------------------

Catalog Numbers

Fluid connection (3)	1/4" BSP female	XMLF001E2045	XMLF001D2035
	1/4" NPT female	XMLF001E2046	XMLF001D2036
Weight, g (oz)		590 (20.81)	480 (16.93)

Additional specifications not shown under general specifications (page 36)

Possible differential (subtract from: – PH to give PB – PH1 & PH2 to get PB1 & PB2)	Min. at low and high setting Max. at high setting	0.03 bar (0.44 psi) 0.95 bar (13.77 psi)	For each stage: min. at low and high setting: 0.03 bar (0.44 psi) max. at high setting: 0.95 bar (13.77 psi)
Maximum permissible accidental pressure		4 bar (58 psi)	
Destructive pressure		6 bar (87 psi)	
Rated supply voltage		120 V~	24 V---
Voltage limits		102–132 V~	17–33 V---
Current consumption		32 mA	80 mA
Output		Relay	Programmable, NPN or PNP, and NO or NC
Time delay		Adjustable time delay on trip and on reset from 0 to 50 s, in increments of 1 s	
Switching capacity		2.5 A, AC-15, C300 (120 V / 1.5 A)	200 mA
Electrical connection		SAE 7/8-16UN, 5-pin male connector. For suitable female pre-wired connectors, see page 64	M12, 4-pin male connector. For suitable female connectors, including pre-wired versions, see page 64

- (1) Pressure switches with adjustable differential for regulation between 2 thresholds. Relay output.
- (2) Pressure switches with 2 adjustable stages and adjustable differential for each threshold. Solid-state outputs.
- (3) Fluids controlled: hydraulic oils, fresh water, sea water, air, corrosive fluids, from –15 to +80 °C (5 to 176 °F). Component materials of units in contact with the fluid: see page 36.

Pressure switch operating curves

(Curve for each stage for dual stage pressure switches)	Pressure switches with relay output	Dual stage pressure switches
---	--	-------------------------------------

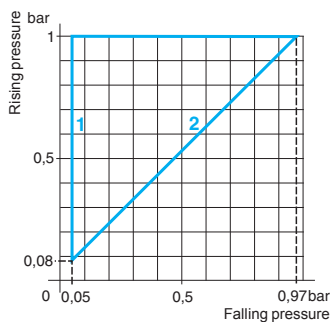

- 1 Maximum differential
- 2 Minimum differential

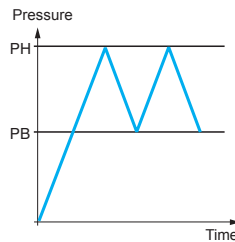

— Adjustable value

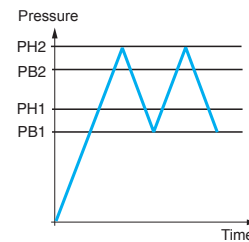

— Adjustable value

OsiSense® XML

Electronic pressure sensors
XMLF pressure sensors
Size: 2.5 bar (36.25 psi)

Type	Pressure transmitters	Universal sensors with adjustable differential. Solid-state and analog outputs (1)
------	-----------------------	--

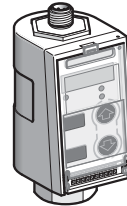

Adjustable range of switching point (PH) (Rising pressure)	—		0.20–2.5 bar (2.9–36.25 psi)	
Analog output	4–20 mA	0–10 V	4–20 mA	0–10 V

Catalog Numbers

Fluid connection (2)	1/4" BSP female	XMLF002D2015	XMLF002D2115	XMLF002D2025	XMLF002D2125
	1/4" NPT female	XMLF002D2016	XMLF002D2116	XMLF002D2026	XMLF002D2126
Weight, g (oz)	480 (16.93)				

Additional specifications not shown under general specifications (page 36)

Possible differential (subtract from PH to give PB)	Min. at low and high setting	—	0.08 bar (1.09 psi)
	Max. at high setting	—	2.38 bar (34.51 psi)
Maximum permissible accidental pressure	10 bar (145 psi)		
Destructive pressure	15 bar (217.5 psi)		
Rated supply voltage	24 V $\overline{--}$		
Voltage limits	17–33 V $\overline{--}$		
Current consumption	80 mA		
Output	—		
Time delay	—		
Switching capacity	—		
Analog output	4–20 mA or 0–10 V, depending on the model. Maximum signal level adjustable between 1.9 and 3.1 bar (27.5 and 44.9 psi)		
Electrical connection	M12, 4-pin male connector. For suitable female connectors, including pre-wired versions, see page 64		

(1) Pressure sensors with adjustable differential for regulation between 2 thresholds. Solid-state and analog outputs.
(2) Fluids controlled: hydraulic oils, fresh water, sea water, air, corrosive fluids, from –15 to +80 °C (5 to 176 °F). Component materials of units in contact with the fluid: see page 36.

Curves

Analog output curve Pressure sensor operating curves

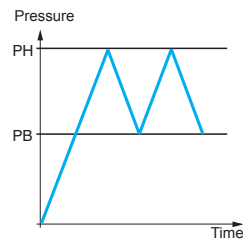
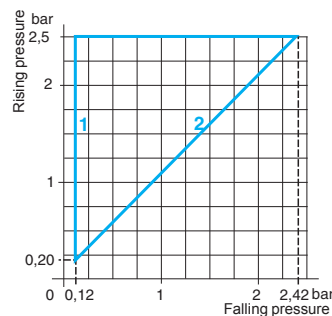
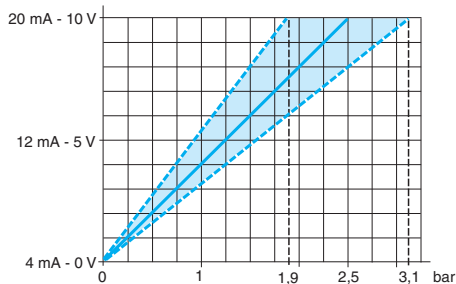

- 1 Maximum differential
- 2 Minimum differential

— Adjustable value

Type	Pressure switches with adjustable differential and relay output (1)	Dual stage adjustable pressure switches with solid-state outputs (2)
------	---	--

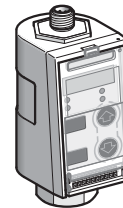
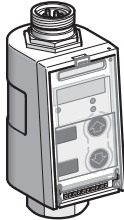

Adjustable range of switching point(s) (PH or PH1 and PH2) (Rising pressure) 0.20–2.5 bar (2.9–36.25 psi)

Catalog Numbers

Fluid connection (3)	1/4" BSP female	XMLF002E2045	XMLF002D2035
	1/4" NPT female	XMLF002E2046	XMLF002D2036
Weight, g (oz)		590 (20.81)	480 (16.93)

Additional specifications not shown under general specifications (page 36)

Possible differential (subtract from: – PH to get PB – PH1 & PH2 to get PB1 & PB2)	Min. at low and high setting Max. at high setting	0.08 bar (1.09 psi) 2.38 bar (34.51 psi)	For each stage: min. at low and high setting: 0.08 bar (1.09 psi) max. at high setting: 2.38 bar (34.51 psi)
Maximum permissible accidental pressure		10 bar (145 psi)	
Destructive pressure		15 bar (217.5 psi)	
Rated supply voltage		120 V~	24 V=
Voltage limits		102–132 V~	17–33 V=
Current consumption		32 mA	80 mA
Output		Relay	Programmable, NPN or PNP, and NO or NC
Time delay		Adjustable time delay on trip and on reset from 0 to 50 s, in increments of 1 s	
Switching capacity		2.5 A, AC-15, C300 (120 V / 1.5 A)	200 mA
Electrical connection		SAE 7/8-16UN, 5-pin male connector. For suitable female pre-wired connectors, see page 64	M12, 4-pin male connector. For suitable female connectors, including pre-wired versions, see page 64

- (1) Pressure switches with adjustable differential for regulation between 2 thresholds. Relay output.
- (2) Pressure switches with 2 adjustable stages and adjustable differential for each threshold. Solid-state outputs.
- (3) Fluids controlled: hydraulic oils, fresh water, sea water, air, corrosive fluids, from –15 to +80 °C (5 to 176 °F). Component materials of units in contact with the fluid: see page 36.

Pressure switch operating curves

(Curve for each stage for dual stage pressure switches)	Pressure switches with relay output	Dual stage pressure switches
---	-------------------------------------	------------------------------

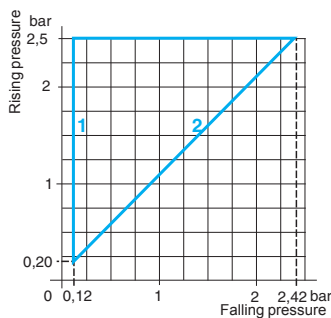

- 1 Maximum differential
- 2 Minimum differential

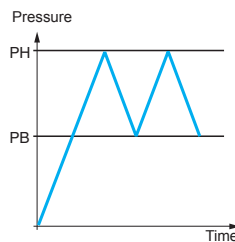

— Adjustable value

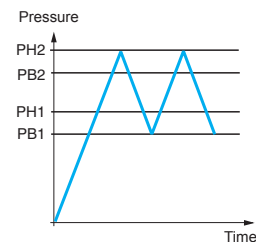

— Adjustable value

OsiSense[®] XML

Electronic pressure sensors
XMLF pressure sensors
Size: 10 bar (145 psi)

Type	Pressure transmitters	Universal sensors with adjustable differential. Solid-state and analog outputs (1)
------	-----------------------	--

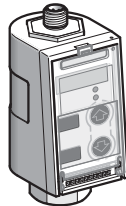

Adjustable range of switching point (PH) (Rising pressure)	—		0.8–10 bar (11.6–145 psi)	
Analog output	4–20 mA	0–10 V	4–20 mA	0–10 V

Catalog Numbers					
Fluid connection (2)	1/4" BSP female	XMLF010D2015	XMLF010D2115	XMLF010D2025	XMLF010D2125
	1/4" NPT female	XMLF010D2016	XMLF010D2116	XMLF010D2026	XMLF010D2126
	SAE 7/16-20UNF female	XMLF010D2019	—	—	—
Weight, g (oz)	480 (16.93)				

Additional specifications not shown under general specifications (page 36)			
Possible differential (subtract from PH to give PB)	Min. at low and high setting	—	0.3 bar (4.4 psi)
	Max. at high setting	—	9.5 bar (137.75 psi)
Maximum permissible accidental pressure	40 bar (580 psi)		
Destructive pressure	60 bar (870 psi)		
Rated supply voltage	24 V $\overline{--}$		
Voltage limits	17–33 V $\overline{--}$		
Current consumption	80 mA		
Output	—		
Time delay	—		
Switching capacity	—		
Analog output	4–20 mA or 0–10 V, depending on the model. Maximum signal level adjustable between 7.5 and 12.5 bar (108.75 and 181.25 psi)		
Electrical connection	M12, 4-pin male connector. For suitable female connectors, including pre-wired versions, see page 64		

(1) Pressure sensors with adjustable differential for regulation between 2 thresholds. Solid-state and analog outputs.
(2) Fluids controlled: hydraulic oils, fresh water, sea water, air, corrosive fluids, from –15 to +80 °C (5 to 176 °F). Component materials of units in contact with the fluid: see page 36.

Curves

Analog output curve

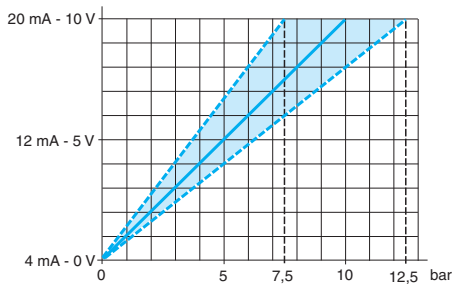

Pressure sensor operating curves

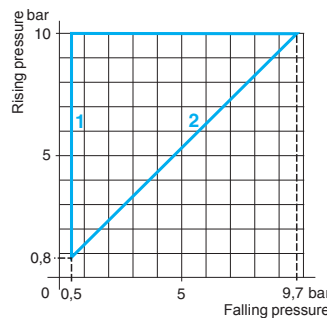

- 1 Maximum differential
- 2 Minimum differential

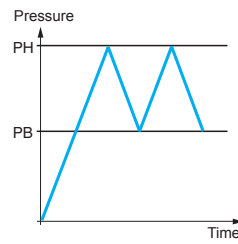

— Adjustable value

Type	Pressure switches with adjustable differential and relay output (1)	Dual stage adjustable pressure switches with solid-state outputs (2)
------	---	--

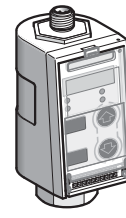
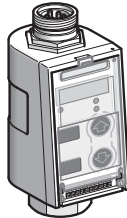

Adjustable range of switching point(s) (PH or PH1 and PH2) (Rising pressure) 0.8–10 bar (11.6–145 psi)

Catalog Numbers

Fluid connection (3)	1/4" BSP female	XMLF010E2045	XMLF010D2035
	1/4" NPT female	XMLF010E2046	XMLF010D2036
	SAE 7/16-20UNF female	XMLF010E2049	XMLF010D2039
Weight, g (oz)		590 (20.81)	480 (16.93)

Additional specifications not shown under general specifications (page 36)

Possible differential (subtract from: – PH to get PB – PH1 & PH2 to get PB1 & PB2)	Min. at low and high setting	0.3 bar (4.4 psi)	For each stage: min. at low and high setting: 0.3 bar (4.4 psi) max. at high setting: 9.5 bar (137.75 psi)
	Max. at high setting	9.5 bar (137.75 psi)	
Maximum permissible accidental pressure		40 bar (580 psi)	
Destructive pressure		60 bar (870 psi)	
Rated supply voltage		120 V~	24 V~
Voltage limits		102–132 V~	17–33 V~
Current consumption		32 mA	80 mA
Output		Relay	Programmable, NPN or PNP, and NO or NC
Time delay		Adjustable time delay on trip and on reset from 0 to 50 s, in increments of 1 s	
Switching capacity		2.5 A, AC-15, C300 (120 V / 1.5 A)	200 mA
Electrical connection		SAE 7/8-16UN, 5-pin male connector. For suitable female pre-wired connectors, see page 64	M12, 4-pin male connector. For suitable female connectors, including pre-wired versions, see page 64

- (1) Pressure switches with adjustable differential for regulation between 2 thresholds. Relay output.
- (2) Pressure switches with 2 adjustable stages and adjustable differential for each threshold. Solid-state outputs.
- (3) Fluids controlled: hydraulic oils, fresh water, sea water, air, corrosive fluids, from –15 to +80 °C (5 to 176 °F). Component materials of units in contact with the fluid: see page 36.

Pressure switch operating curves

(Curve for each stage for dual stage pressure switches) Pressure switches with relay output Dual stage pressure switches

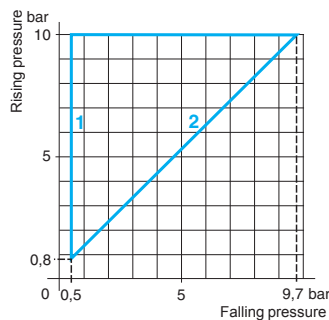

- 1 Maximum differential
- 2 Minimum differential

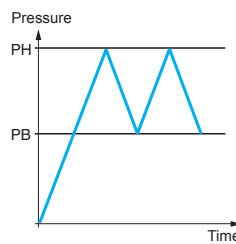

— Adjustable value

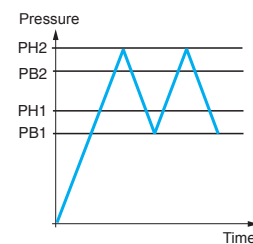

— Adjustable value

OsiSense® XML

Electronic pressure sensors
XMLF pressure sensors
Size: 16 bar (232 psi)

Type	Pressure transmitters	Universal sensors with adjustable differential. Solid-state and analog outputs (1)
------	-----------------------	--



Adjustable range of switching point (PH) (Rising pressure)	—		1.28–16 bar (18.56–232 psi)	
Analog output	4–20 mA	0–10 V	4–20 mA	0–10 V

Catalog Numbers					
Fluid connection (2)	1/4" BSP female	XMLF016D2015	XMLF016D2115	XMLF016D2025	XMLF016D2125
	1/4" NPT female	XMLF016D2016	XMLF016D2116	XMLF016D2026	XMLF016D2126
	SAE 7/16-20UNF female	—	—	—	XMLF016D2129
Weight, g (oz)	480 (16.93)				

Additional specifications not shown under general specifications (page 36)			
Possible differential (subtract from PH to give PB)	Min. at low and high setting	—	0.48 bar (6.96 psi)
	Max. at high setting	—	15.2 bar (220.4 psi)
Maximum permissible accidental pressure	64 bar (928 psi)		
Destructive pressure	96 bar (1392 psi)		
Rated supply voltage	24 V $\overline{--}$		
Voltage limits	17–33 V $\overline{--}$		
Current consumption	80 mA		
Output	—		
Time delay	—		
Switching capacity	—		
Analog output	4–20 mA or 0–10 V, depending on the model. Maximum signal level adjustable between 12 and 20 bar (174 and 290 psi)		
Electrical connection	M12, 4-pin male connector. For suitable female connectors, including pre-wired versions, see page 64		

(1) Pressure sensors with adjustable differential for regulation between 2 thresholds. Solid-state and analog outputs.
(2) Fluids controlled: hydraulic oils, fresh water, sea water, air, corrosive fluids, from –15 to +80 °C (5 to 176 °F). Component materials of units in contact with the fluid: see page 36.

Curves

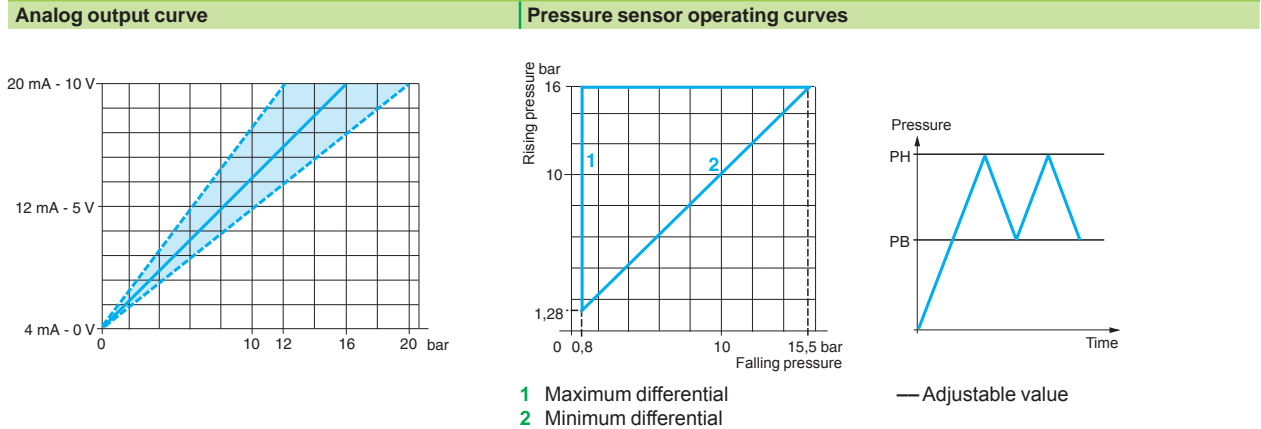

Type	Pressure switches with adjustable differential and relay output (1)	Dual stage adjustable pressure switches with solid-state outputs (2)
------	---	--

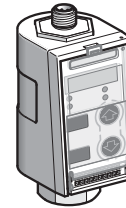
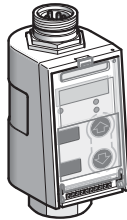

Adjustable range of switching point(s) (PH or PH1 and PH2) (Rising pressure)	1.28–16 bar (18.56–232 psi)
--	-----------------------------

Catalog Numbers

Fluid connection (3)	1/4" BSP female	XMLF016E2045	XMLF016D2035
	1/4" NPT female	XMLF016E2046	XMLF016D2036
Weight, g (oz)		590 (20.81)	480 (16.93)

Additional specifications not shown under general specifications (page 36)

Possible differential (subtract from: – PH to get PB – PH1 & PH2 to get PB1 & PB2)	Min. at low and high setting	0.48 bar (6.96 psi)	For each stage: min. at low and high setting: 0.48 bar (6.96 psi) max. at high setting: 15.2 bar (220.4 psi)
	Max. at high setting	15.2 bar (220.4 psi)	
Maximum permissible accidental pressure		64 bar (928 psi)	
Destructive pressure		96 bar (1392 psi)	
Rated supply voltage		120 V~	24 V---
Voltage limits		102–132 V~	17–33 V---
Current consumption		32 mA	80 mA
Output		Relay	Programmable, NPN or PNP, and NO or NC
Time delay		Adjustable time delay on trip and on reset from 0 to 50 s, in increments of 1 s	
Switching capacity		2.5 A, AC-15, C300 (120 V / 1.5 A)	200 mA
Electrical connection		SAE 7/8-16UN, 5-pin male connector. For suitable female pre-wired connectors, see page 64	M12, 4-pin male connector. For suitable female connectors, including pre-wired versions, see page 64

- (1) Pressure switches with adjustable differential for regulation between 2 thresholds. Relay output.
- (2) Pressure switches with 2 adjustable stages and adjustable differential for each threshold. Solid-state outputs.
- (3) Fluids controlled: hydraulic oils, fresh water, sea water, air, corrosive fluids, from –15 to +80 °C (5 to 176 °F). Component materials of units in contact with the fluid: see page 36.

Pressure switch operating curves

(Curve for each stage for dual stage pressure switches)	Pressure switches with relay output	Dual stage pressure switches
---	-------------------------------------	------------------------------

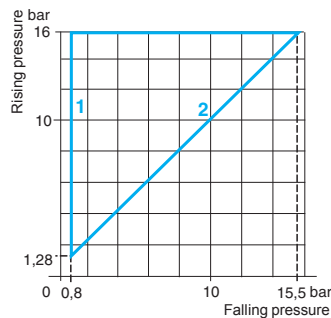

- 1 Maximum differential
- 2 Minimum differential

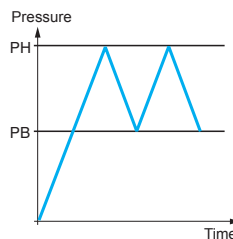

— Adjustable value

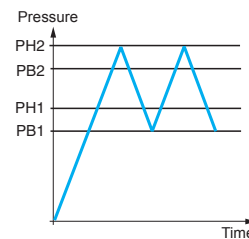

— Adjustable value

OsiSense[®] XML

Electronic pressure sensors
XMLF pressure sensors
Size: 25 bar (362.5 psi)

Type	Pressure transmitters	Universal sensors with adjustable differential. Solid-state and analog outputs (1)
------	-----------------------	--

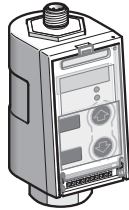

Adjustable range of switching point (PH) (Rising pressure)	—		2–25 bar (29–362.5 psi)	
Analog output	4–20 mA	0–10 V	4–20 mA	0–10 V

Catalog Numbers

Fluid connection (2)	1/4" BSP female	XMLF025D2015	XMLF025D2115	XMLF025D2025	XMLF025D2125
	1/4" NPT female	XMLF025D2016	XMLF025D2116	XMLF025D2026	XMLF025D2126
Weight, g (oz)	480 (16.93)				

Additional specifications not shown under general specifications (page 36)

Possible differential (subtract from PH to give PB)	Min. at low and high setting	—	0.75 bar (10.9 psi)
	Max. at high setting	—	23.8 bar (345.1 psi)
Maximum permissible accidental pressure	100 bar (1450 psi)		
Destructive pressure	150 bar (2175 psi)		
Rated supply voltage	24 V $\overline{--}$		
Voltage limits	17–33 V $\overline{--}$		
Current consumption	80 mA		
Output	—		
Time delay	—		
Switching capacity	—		
Analog output	4–20 mA or 0–10 V, depending on the model. Maximum signal level adjustable between 18.8 and 31.2 bar (272.6 and 452.4 psi)		
Electrical connection	M12, 4-pin male connector. For suitable female connectors, including pre-wired versions, see page 64		

(1) Pressure sensors with adjustable differential for regulation between 2 thresholds. Solid-state and analog outputs.

(2) Fluids controlled: hydraulic oils, fresh water, sea water, air, corrosive fluids, from –15 to +80 °C (5 to 176 °F). Component materials of units in contact with the fluid: see page 36.

Curves

Analog output curve | Pressure sensor operating curves

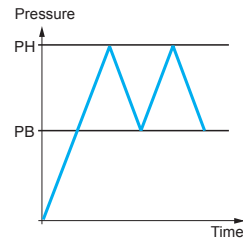
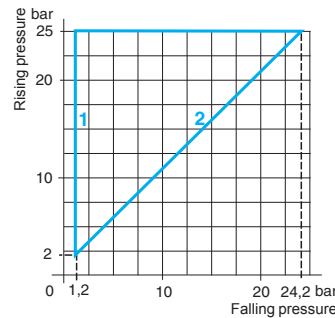
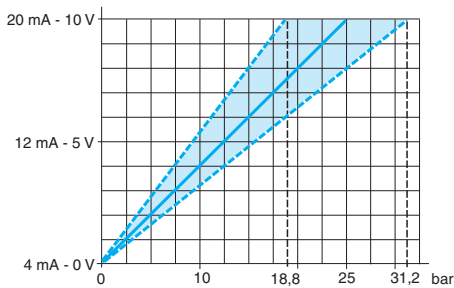

- 1 Maximum differential
- 2 Minimum differential

— Adjustable value

Type	Pressure switches with adjustable differential and relay output (1)	Dual stage adjustable pressure switches with solid-state outputs (2)
------	---	--

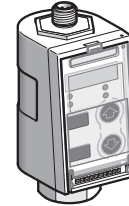
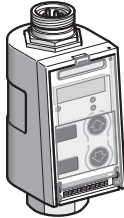

Adjustable range of switching point(s) (PH or PH1 and PH2) (Rising pressure)	2–25 bar (29–362.5 psi)
--	-------------------------

Catalog Numbers

Fluid connection (3)	1/4" BSP female	XMLF025E2045	XMLF025D2035
	1/4" NPT female	XMLF025E2046	XMLF025D2036
Weight, g (oz)		590 (20.81)	480 (16.93)

Additional specifications not shown under general specifications (page 36)

Possible differential (subtract from: – PH to get PB – PH1 & PH2 to get PB1 & PB2)	Min. at low and high setting Max. at high setting	0.75 bar (10.9 psi) 23.8 bar (345.1 psi)	For each stage: min. at low and high setting: 0.75 bar (10.9 psi) max. at high setting: 23.8 bar (345.1 psi)
Maximum permissible accidental pressure		100 bar (1450 psi)	
Destructive pressure		150 bar (2175 psi)	
Rated supply voltage		120 V~	24 V~
Voltage limits		102–132 V~	17–33 V~
Current consumption		32 mA	80 mA
Output		Relay	Programmable, NPN or PNP, and NO or NC
Time delay		Adjustable time delay on trip and on reset from 0 to 50 s, in increments of 1 s	
Switching capacity		2.5 A, AC-15, C300 (120 V / 1.5 A)	200 mA
Electrical connection		SAE 7/8-16UN, 5-pin male connector. For suitable female pre-wired connectors, see page 64	M12, 4-pin male connector. For suitable female connectors, including pre-wired versions, see page 64

- (1) Pressure switches with adjustable differential for regulation between 2 thresholds. Relay output.
- (2) Pressure switches with 2 adjustable stages and adjustable differential for each threshold. Solid-state outputs.
- (3) Fluids controlled: hydraulic oils, fresh water, sea water, air, corrosive fluids, from –15 to +80 °C (5 to 176 °F). Component materials of units in contact with the fluid: see page 36.

Pressure switch operating curves

(Curve for each stage for dual stage pressure switches)	Pressure switches with relay output	Dual stage pressure switches
---	-------------------------------------	------------------------------

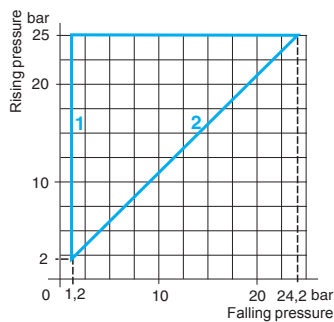

- 1 Maximum differential
- 2 Minimum differential

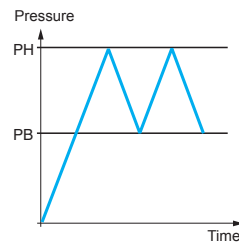

— Adjustable value

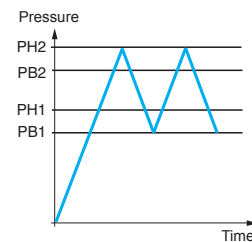

— Adjustable value

OsiSense[®] XML

Electronic pressure sensors
XMLF pressure sensors
Size: 40 bar (580 psi)

Type	Pressure transmitters	Universal sensors with adjustable differential. Solid-state and analog outputs (1)
------	-----------------------	--



Adjustable range of switching point (PH) (Rising pressure)	—		3.2–40 bar (46.4–580 psi)	
Analog output	4–20 mA	0–10 V	4–20 mA	0–10 V

Catalog Numbers

Fluid connection (2)	1/4" BSP female	XMLF040D2015	XMLF040D2115	XMLF040D2025	XMLF040D2125
	1/4" NPT female	XMLF040D2016	XMLF040D2116	XMLF040D2026	XMLF040D2126
Weight, g (oz)	500 (17.64)				

Additional specifications not shown under general specifications (page 36)

Possible differential (subtract from PH to give PB)	Min. at low and high setting	—	1.2 bar (17.4 psi)
	Max. at high setting	—	38 bar (551 psi)
Maximum permissible accidental pressure	160 bar (2320 psi)		
Destructive pressure	240 bar (3480 psi)		
Rated supply voltage	24 V [—]		
Voltage limits	17–33 V [—]		
Current consumption	80 mA		
Output	—		
Time delay	—		
Switching capacity	—		
Analog output	4–20 mA or 0–10 V, depending on the model. Maximum signal level adjustable between 30 and 50 bar (435 and 725 psi)		
Electrical connection	M12, 4-pin male connector. For suitable female connectors, including pre-wired versions, see page 64		

(1) Pressure sensors with adjustable differential for regulation between 2 thresholds. Solid-state and analog outputs.
(2) Fluids controlled: hydraulic oils, fresh water, sea water, air, corrosive fluids, from –15 to +80 °C (5 to 176 °F). Component materials of units in contact with the fluid: see page 36.

Curves

Analog output curve Pressure sensor operating curves

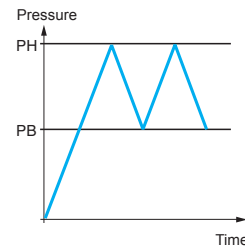
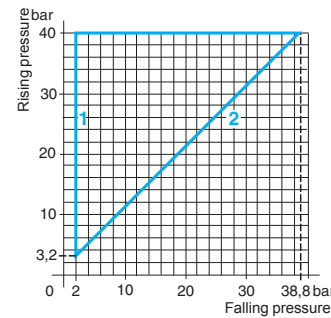
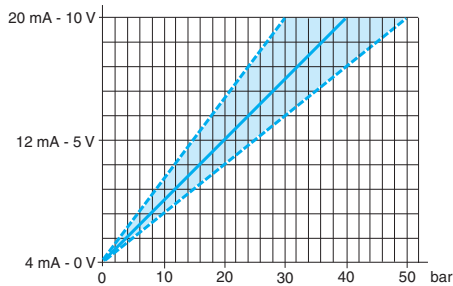

- 1 Maximum differential
- 2 Minimum differential

— Adjustable value

Type	Pressure switches with adjustable differential and relay output (1)	Dual stage adjustable pressure switches with solid-state outputs (2)
------	---	--

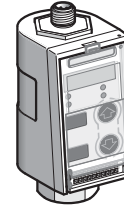
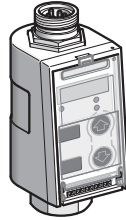

Adjustable range of switching point(s) (PH or PH1 and PH2) (Rising pressure)	3.2–40 bar (46.4–580 psi)
--	---------------------------

Catalog Numbers

Fluid connection (3)	1/4" BSP female 1/4" NPT female	XMLF040E2045 XMLF040E2046	XMLF040D2035 XMLF040D2036
Weight, g (oz)		610 (21.52)	500 (17.64)

Additional specifications not shown under general specifications (page 36)

Possible differential (subtract from: – PH to get PB – PH1 & PH2 to get PB1 & PB2)	Min. at low and high setting Max. at high setting	1.2 bar (17.4 psi) 38 bar (551 psi)	For each stage: min. at low and high setting: 1.2 bar (17.4 psi) max. at high setting: 38 bar (551 psi)
Maximum permissible accidental pressure		160 bar (2320 psi)	
Destructive pressure		240 bar (3480 psi)	
Rated supply voltage		120 V~	24 V~
Voltage limits		102–132 V~	17–33 V~
Current consumption		32 mA	80 mA
Output		Relay	Programmable, NPN or PNP, and NO or NC
Time delay		Adjustable time delay on trip and on reset from 0 to 50 s, in increments of 1 s	
Switching capacity		2.5 A, AC-15, C300 (120 V / 1.5 A)	200 mA
Electrical connection		SAE 7/8-16UN, 5-pin male connector. For suitable female pre-wired connectors, see page 64	M12, 4-pin male connector. For suitable female connectors, including pre-wired versions, see page 64

- (1) Pressure switches with adjustable differential for regulation between 2 thresholds. Relay output.
- (2) Pressure switches with 2 adjustable stages and adjustable differential for each threshold. Solid-state outputs.
- (3) Fluids controlled: hydraulic oils, fresh water, sea water, air, corrosive fluids, from –15 to +80 °C (5 to 176 °F). Component materials of units in contact with the fluid: see page 36.

Pressure switch operating curves

(Curve for each stage for dual stage pressure switches)	Pressure switches with relay output	Dual stage pressure switches
---	-------------------------------------	------------------------------

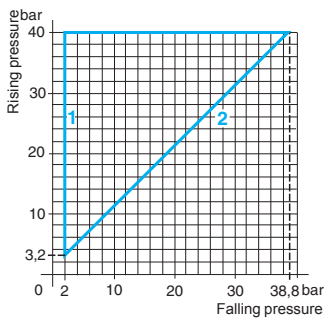

- 1 Maximum differential
- 2 Minimum differential

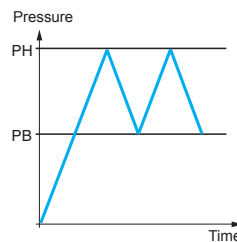

— Adjustable value

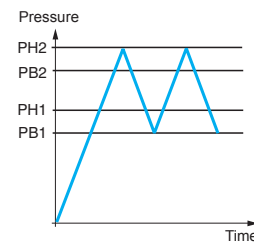

— Adjustable value

Type	Pressure transmitters	Universal sensors with adjustable differential. Solid-state and analog outputs (1)
------	-----------------------	--

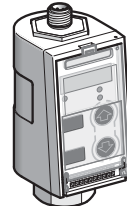

Adjustable range of switching point (PH) (Rising pressure)	—		5.6–70 bar (81.2–1015 psi)	
Analog output	4–20 mA	0–10 V	4–20 mA	0–10 V

Catalog Numbers					
Fluid connection (2)	1/4" BSP female	XMLF070D2015	XMLF070D2115	XMLF070D2025	XMLF070D2125
	1/4" NPT female	XMLF070D2016	XMLF070D2116	XMLF070D2026	XMLF070D2126
	SAE 7/16-20UNF female	—	—	XMLF070D2029	—
Weight, g (oz)	500 (17.64)				

Additional specifications not shown under general specifications (page 36)			
Possible differential (subtract from PH to give PB)	Min. at low and high setting	—	2.1 bar (30.5 psi)
	Max. at high setting	—	66.5 bar (964.2 psi)
Maximum permissible accidental pressure	280 bar (4060 psi)		
Destructive pressure	420 bar (6090 psi)		
Rated supply voltage	24 V $\overline{--}$		
Voltage limits	17–33 V $\overline{--}$		
Current consumption	80 mA		
Output	—		
Time delay	—		
Switching capacity	—		
Analog output	4–20 mA or 0–10 V, depending on the model. Maximum signal level adjustable between 52.5 and 87.5 bar (761.3 and 1268.7 psi)		
Electrical connection	M12, 4-pin male connector. For suitable female connectors, including pre-wired versions, see page 64		

(1) Pressure sensors with adjustable differential for regulation between 2 thresholds. Solid-state and analog outputs.
(2) Fluids controlled: hydraulic oils, fresh water, sea water, air, corrosive fluids, from –15 to +80 °C (5 to 176 °F). Component materials of units in contact with the fluid: see page 36.

Curves

Analog output curve Pressure sensor operating curves

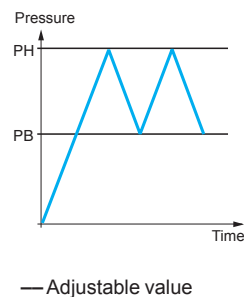
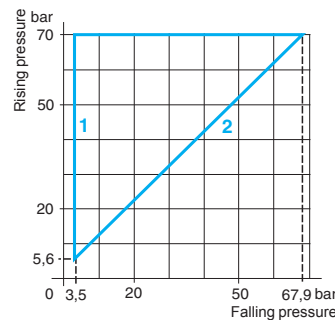
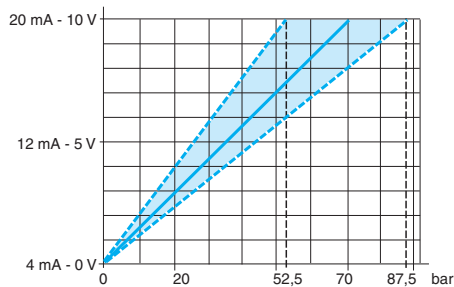

1 Maximum differential
2 Minimum differential

— Adjustable value

Type	Pressure switches with adjustable differential and relay output (1)	Dual stage adjustable pressure switches with solid-state outputs (2)
------	---	--

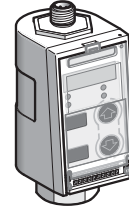
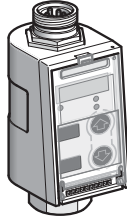

Adjustable range of switching point(s) (PH or PH1 and PH2) (Rising pressure) 5.6–70 bar (81.2–1015 psi)

Catalog Numbers

Fluid connection (3)	1/4" BSP female	XMLF070E2045	XMLF070D2035
	1/4" NPT female	XMLF070E2046	XMLF070D2036
	SAE 7/16-20UNF female	—	XMLF070D2039
Weight, g (oz)		610 (21.52)	500 (17.64)

Additional specifications not shown under general specifications (page 36)

Possible differential (subtract from: – PH to get PB – PH1 & PH2 to get PB1 & PB2)	Min. at low and high setting Max. at high setting	2.1 bar (30.5 psi) 66.5 bar (964.2 psi)	For each stage: min. at low and high setting: 2.1 bar (30.5 psi) max. at high setting: 66.5 bar (964.2 psi)
Maximum permissible accidental pressure		280 bar (4060 psi)	
Destructive pressure		420 bar (6090 psi)	
Rated supply voltage		120 V~	24 V---
Voltage limits		102–132 V~	17–33 V---
Current consumption		32 mA	80 mA
Output		Relay	Programmable, NPN or PNP, and NO or NC
Time delay		Adjustable time delay on trip and on reset from 0 to 50 s, in increments of 1 s	
Switching capacity		2.5 A, AC-15, C300 (120 V / 1.5 A)	200 mA
Electrical connection		SAE 7/8-16UN, 5-pin male connector. For suitable female pre-wired connectors, see page 64	M12, 4-pin male connector. For suitable female connectors, including pre-wired versions, see page 64

- (1) Pressure switches with adjustable differential for regulation between 2 thresholds. Relay output.
- (2) Pressure switches with 2 adjustable stages and adjustable differential for each threshold. Solid-state outputs.
- (3) Fluids controlled: hydraulic oils, fresh water, sea water, air, corrosive fluids, from –15 to +80 °C (5 to 176 °F). Component materials of units in contact with the fluid: see page 36.

Pressure switch operating curves

(Curve for each stage for dual stage pressure switches) Pressure switches with relay output Dual stage pressure switches

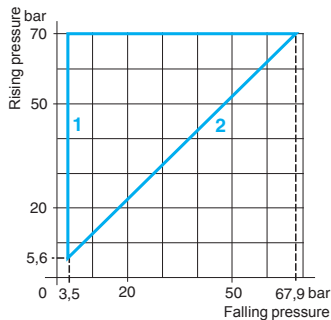

- 1 Maximum differential
- 2 Minimum differential

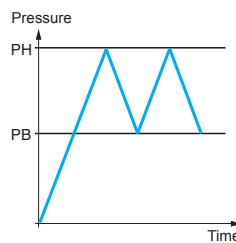

— Adjustable value

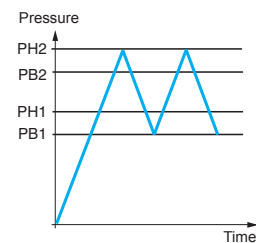

— Adjustable value

Type	Pressure transmitters	Universal sensors with adjustable differential. Solid-state and analog outputs (1)
------	-----------------------	--

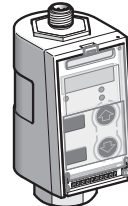
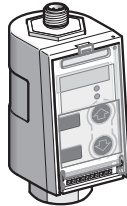

Adjustable range of switching point (PH) (Rising pressure)	—	8–100 bar (116–1450 psi)
Analog output	4–20 mA	0–10 V

Catalog Numbers

Fluid connection (2)	1/4" BSP female	XMLF100D2015	XMLF100D2115	XMLF100D2025	XMLF100D2125
	1/4" NPT female	XMLF100D2016	XMLF100D2116	XMLF100D2026	XMLF100D2126
Weight, g (oz)	500 (17.64)				

Additional specifications not shown under general specifications (page 36)

Possible differential (subtract from PH to give PB)	Min. at low and high setting	—	3 bar (43.5 psi)
	Max. at high setting	—	95 bar (1377.5 psi)
Maximum permissible accidental pressure	400 bar (5800 psi)		
Destructive pressure	600 bar (8700 psi)		
Rated supply voltage	24 V $\overline{--}$		
Voltage limits	17–33 V $\overline{--}$		
Current consumption	80 mA		
Output	—		
Time delay	—		
Switching capacity	—		
Analog output	4–20 mA or 0–10 V, depending on the model. Maximum signal level adjustable between 75 and 125 bar (1087.5 and 1812.5 psi)		
Electrical connection	M12, 4-pin male connector. For suitable female connectors, including pre-wired versions, see page 64		

(1) Pressure sensors with adjustable differential for regulation between 2 thresholds. Solid-state and analog outputs.
 (2) Fluids controlled: hydraulic oils, fresh water, sea water, air, corrosive fluids, from –15 to +80 °C (5 to 176 °F). Component materials of units in contact with the fluid: see page 36.

Curves
 Analog output curve | Pressure sensor operating curves

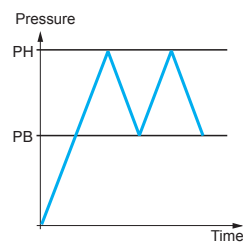
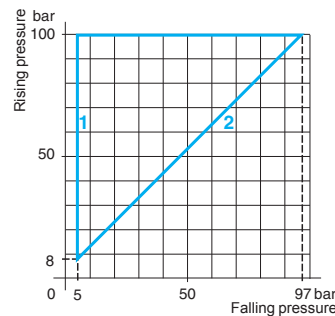
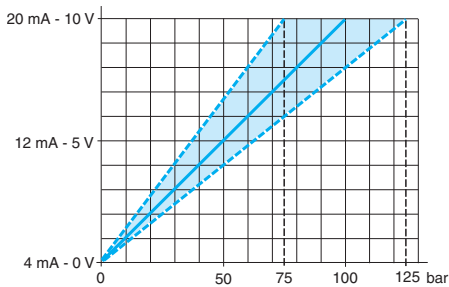

- 1 Maximum differential
- 2 Minimum differential

— Adjustable value

Type	Pressure switches with adjustable differential and relay output (1)	Dual stage adjustable pressure switches with solid-state outputs (2)
------	---	--

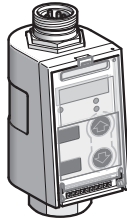

Adjustable range of switching point(s) (PH or PH1 and PH2) (Rising pressure) 8–100 bar (116–1450 psi)

Catalog Numbers

Fluid connection (3)	1/4" BSP female	XMLF100E2045	XMLF100D2035
	1/4" NPT female	XMLF100E2046	XMLF100D2036
Weight, g (oz)		610 (21.52)	500 (17.64)

Additional specifications not shown under general specifications (page 36)

Possible differential (subtract from: – PH to get PB – PH1 & PH2 to get PB1 & PB2)	Min. at low and high setting	3 bar (43.5 psi)	For each stage: min. at low and high setting: 3 bar (43.5 psi) max. at high setting: 95 bar (1377.5 psi)
	Max. at high setting	95 bar (1377.5 psi)	
Maximum permissible accidental pressure		400 bar (5800 psi)	
Destructive pressure		600 bar (8700 psi)	
Rated supply voltage		120 V~	24 V~
Voltage limits		102–132 V~	17–33 V~
Current consumption		32 mA	80 mA
Output		Relay	Programmable, NPN or PNP, and NO or NC
Time delay		Adjustable time delay on trip and on reset from 0 to 50 s, in increments of 1 s	
Switching capacity		2.5 A, AC-15, C300 (120 V / 1.5 A)	200 mA
Electrical connection		SAE 7/8-16UN, 5-pin male connector. For suitable female pre-wired connectors, see page 64	M12, 4-pin male connector. For suitable female connectors, including pre-wired versions, see page 64

- (1) Pressure switches with adjustable differential for regulation between 2 thresholds. Relay output.
- (2) Pressure switches with 2 adjustable stages and adjustable differential for each threshold. Solid-state outputs.
- (3) Fluids controlled: hydraulic oils, fresh water, sea water, air, corrosive fluids, from –15 to +80 °C (5 to 176 °F). Component materials of units in contact with the fluid: see page 36.

Pressure switch operating curves

(Curve for each stage for dual stage pressure switches) **Pressure switches with relay output** **Dual stage pressure switches**

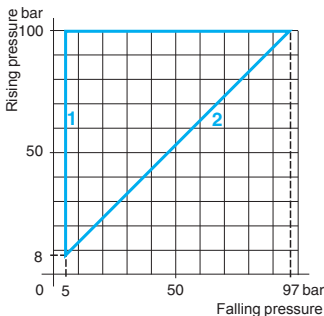

- 1 Maximum differential
- 2 Minimum differential

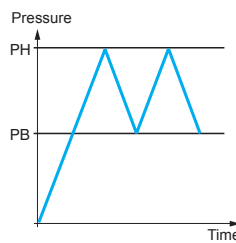

— Adjustable value

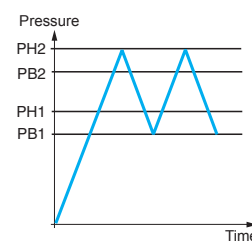

— Adjustable value

OsiSense® XML

Electronic pressure sensors
XMLF pressure sensors
Size: 160 bar (2320 psi)

Type	Pressure transmitters	Universal sensors with adjustable differential. Solid-state and analog outputs (1)
------	-----------------------	--

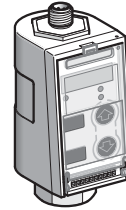
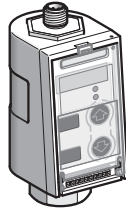

Adjustable range of switching point (PH) (Rising pressure)	—		12.8–160 bar (185.6–2320 psi)	
Analog output	4–20 mA	0–10 V	4–20 mA	0–10 V

Catalog Numbers

Fluid connection	1/4" BSP female	XMLF160D2015	XMLF160D2115	XMLF160D2025	XMLF160D2125
(2)	1/4" NPT female	XMLF160D2016	XMLF160D2116	XMLF160D2026	XMLF160D2126
Weight, g (oz)	590 (20.81)				

Additional specifications not shown under general specifications (page 36)

Possible differential (subtract from PH to give PB)	Min. at low and high setting	—	4.8 bar (69.6 psi)
	Max. at high setting	—	152 bar (2204 psi)
Maximum permissible occasional surge pressure	640 bar (9280 psi)		
Destructive pressure	960 bar (13,920 psi)		
Rated supply voltage	24 V $\overline{--}$		
Voltage limits	17–33 V $\overline{--}$		
Current consumption	80 mA		
Output	—		
Time delay	—		Programmable, NPN or PNP, and NO or NC
Switching capacity	—		Adjustable time delay on trip and on reset from 0 to 50 s, in increments of 1 s
Analog output	—		
Electrical connection	200 mA		
	4–20 mA or 0–10 V, depending on the model. Maximum signal level adjustable between 120 and 200 bar (1740 and 2900 psi)		
	M12, 4-pin male connector. For suitable female connectors, including pre-wired versions, see page 64		

(1) Pressure sensors with adjustable differential for regulation between 2 thresholds. Solid-state and analog outputs.
(2) Fluids controlled: hydraulic oils, fresh water, sea water, air, corrosive fluids, from –15 to +80 °C (5 to 176 °F). Component materials of units in contact with the fluid: see page 36.

Curves

Analog output curve

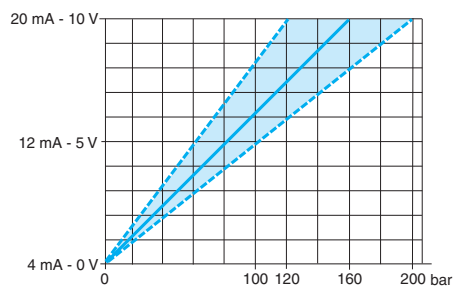

Pressure sensor operating curves

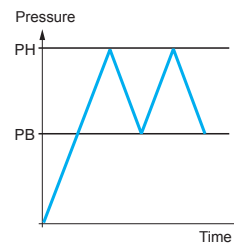
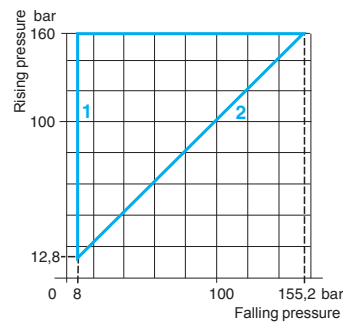

- 1 Maximum differential
- 2 Minimum differential

— Adjustable value

Type	Pressure switches with adjustable differential and relay output (1)	Dual stage adjustable pressure switches with solid-state outputs (2)
------	---	--

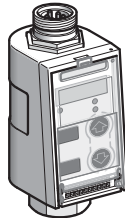

Adjustable range of switching point(s) (PH or PH1 and PH2) (Rising pressure) | 12.8–160 bar (185.6–2320 psi)

Catalog Numbers

Fluid connection (3)	1/4" BSP female	XMLF160E2045	XMLF160D2035
	1/4" NPT female	XMLF160E2046	XMLF160D2036
	SAE 7/16-20UNF female	—	XMLF160D2039
Weight, g (oz)		700 (24.69)	590 (20.81)

Additional specifications not shown under general specifications (page 36)

Possible differential (subtract from: – PH to get PB – PH1 & PH2 to get PB1 & PB2)	Min. at low and high setting	4.8 bar (69.6 psi)	For each stage: min. at low and high setting: 4.8 bar (69.6 psi) max. at high setting: 152 bar (2204 psi)
	Max. at high setting	152 bar (2204 psi)	
Maximum permissible accidental pressure		640 bar (9280 psi)	
Destructive pressure		960 bar (13,920 psi)	
Rated supply voltage		120 V~	24 V---
Voltage limits		102–132 V~	17–33 V---
Current consumption		32 mA	80 mA
Output		Relay	Programmable, NPN or PNP, and NO or NC
Time delay		Adjustable time delay on trip and on reset from 0 to 50 s, in increments of 1 s	
Switching capacity		2.5 A, AC-15, C300 (120 V / 1.5 A)	200 mA
Electrical connection		SAE 7/8-16UN, 5-pin male connector. For suitable female pre-wired connectors, see page 64	M12, 4-pin male connector. For suitable female connectors, including pre-wired versions, see page 64

- (1) Pressure switches with adjustable differential for regulation between 2 thresholds. Relay output.
- (2) Pressure switches with 2 adjustable stages and adjustable differential for each threshold. Solid-state outputs.
- (3) Fluids controlled: hydraulic oils, fresh water, sea water, air, corrosive fluids, from –15 to +80 °C (5 to 176 °F). Component materials of units in contact with the fluid: see page 36.

Pressure switch operating curves

(Curve for each stage for dual stage pressure switches) | Pressure switches with relay output | Dual stage pressure switches

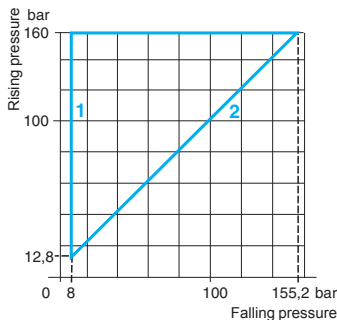

- 1 Maximum differential
- 2 Minimum differential

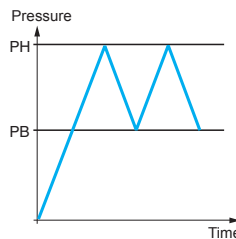

— Adjustable value

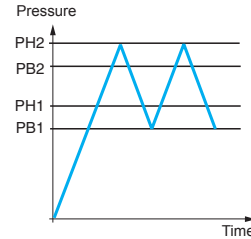

— Adjustable value

Type	Pressure transmitters	Universal sensors with adjustable differential. Solid-state and analog outputs (1)
------	-----------------------	--

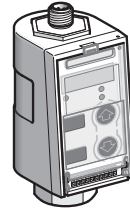
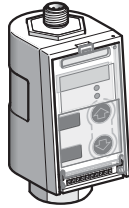

Adjustable range of switching point (PH) (Rising pressure)	—		20–250 bar (290–3625 psi)	
Analog output	4–20 mA	0–10 V	4–20 mA	0–10 V

Catalog Numbers

Fluid connection (2)	1/4" BSP female	XMLF250D2015	XMLF250D2115	XMLF250D2025	XMLF250D2125
	1/4" NPT female	XMLF250D2016	XMLF250D2116	XMLF250D2026	XMLF250D2126
	SAE 7/16-20UNF female	—	—	—	XMLF250D2129
Weight, g (oz)	590 (20.81)				

Additional specifications not shown under general specifications (page 36)

Possible differential (subtract from PH to give PB)	Min. at low and high setting	—	7.5 bar (108.8 psi)
	Max. at high setting	—	237.5 bar (3443.7 psi)
Maximum permissible accidental pressure	1000 bar (14,500 psi)		
Destructive pressure	1500 bar (21,750 psi)		
Rated supply voltage	24 V $\overline{--}$		
Voltage limits	17–33 V $\overline{--}$		
Current consumption	80 mA		
Output	—		
Time delay	—		
Switching capacity	—		
Analog output	4–20 mA or 0–10 V, depending on the model. Maximum signal level adjustable between 187 and 312 bar (2711 and 4524 psi)		
Electrical connection	M12, 4-pin male connector. For suitable female connectors, including pre-wired versions, see page 64		

(1) Pressure sensors with adjustable differential for regulation between 2 thresholds. Solid-state and analog outputs.
 (2) Fluids controlled: hydraulic oils, fresh water, sea water, air, corrosive fluids, from –15 to +80 °C (5 to 176 °F). Component materials of units in contact with the fluid: see page 36.

Curves

Analog output curve **Pressure sensor operating curves**

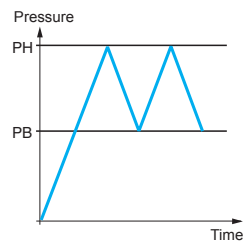
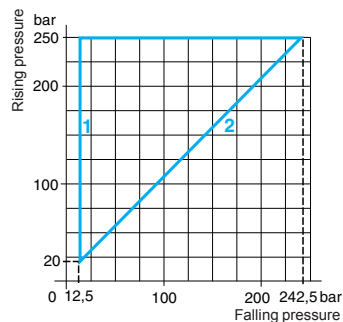
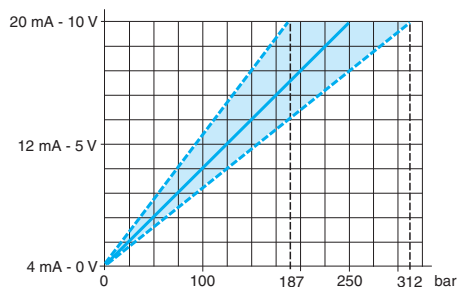

- 1 Maximum differential
- 2 Minimum differential

— Adjustable value

Type	Pressure switches with adjustable differential and relay output (1)	Dual stage adjustable pressure switches with solid-state outputs (2)
------	---	--

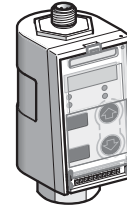
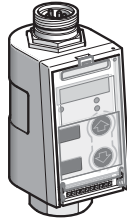

Adjustable range of switching point(s) (PH or PH1 and PH2) (Rising pressure) 20–250 bar (290–3625 psi)

Catalog Numbers

Fluid connection (3)	1/4" BSP female	XMLF250E2045	XMLF250D2035
	1/4" NPT female	XMLF250E2046	XMLF250D2036
	SAE 7/16-20UNF female	—	XMLF250D2039
Weight, g (oz)		700 (24.69)	590 (20.81)

Additional specifications not shown under general specifications (page 36)

Possible differential (subtract from: – PH1 to get PB – PH1 & PH2 to get PB1 & PB2)	Min. at low and high setting	7.5 bar (108.8 psi)	For each stage: Min. at low and high setting: 7.5 bar (108.8 psi) Max. at high setting: 237.5 bar (3443.7 psi)
	Max. at high setting	237.5 bar (3443.7 psi)	
Maximum permissible accidental pressure		1000 bar (14,500 psi)	
Destructive pressure		1500 bar (21,750 psi)	
Rated supply voltage		120 V~	24 V--
Voltage limits		102–132 V~	17–33 V--
Current consumption		32 mA	80 mA
Output		Relay	Programmable, NPN or PNP, and NO or NC
Time delay		Adjustable time delay on trip and on reset from 0 to 50 s, in increments of 1 s	
Switching capacity		2.5 A, AC-15, C300 (120 V / 1.5 A)	200 mA
Electrical connection		SAE 7/8-16UN, 5-pin male connector. For suitable female pre-wired connectors, see page 64	M12, 4-pin male connector. For suitable female connectors, including pre-wired versions, see page 64

- (1) Pressure switches with adjustable differential for regulation between 2 thresholds. Relay output.
- (2) Pressure switches with 2 adjustable stages and adjustable differential for each threshold. Solid-state outputs.
- (3) Fluids controlled: hydraulic oils, fresh water, sea water, air, corrosive fluids, from –15 to +80 °C (5 to 176 °F). Component materials of units in contact with the fluid: see page 36.

Pressure switch operating curves

(Curve for each stage for dual stage pressure switches)	Pressure switches with relay output	Dual stage pressure switches
---	-------------------------------------	------------------------------

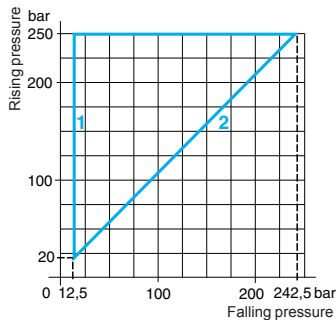

- 1 Maximum differential
- 2 Minimum differential

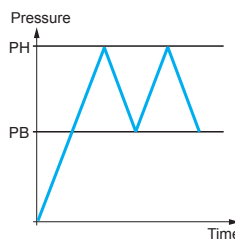

— Adjustable value

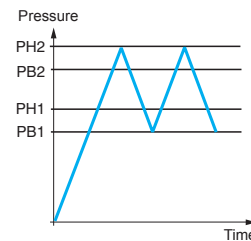

— Adjustable value

OsiSense® XML

Electronic pressure sensors
XMLF pressure sensors
Size: 400 bar (5800 psi)

Type	Pressure transmitters	Universal sensors with adjustable differential. Solid-state and analog outputs (1)
------	-----------------------	--



Adjustable range of switching point (PH) (Rising pressure)	—		32–400 bar (464–5800 psi)	
Analog output	4–20 mA	0–10 V	4–20 mA	0–10 V

Catalog Numbers					
Fluid connection (2)	1/4" BSP female	XMLF400D2015	XMLF400D2115	XMLF400D2025	XMLF400D2125
	1/4" NPT female	XMLF400D2016	XMLF400D2116	XMLF400D2026	XMLF400D2126
	SAE 7/16-20UNF female	—	XMLF400D2119	XMLF400D2029	—
Weight, g (oz)	590 (20.81)				

Additional specifications not shown under general specifications (page 36)			
Possible differential (subtract from PH to give PB)	Min. at low and high setting	—	12 bar (174 psi)
	Max. at high setting	—	380 bar (5510 psi)
Maximum permissible accidental pressure	1200 bar (17,400 psi)		
Destructive pressure	1800 bar (26,100 psi)		
Rated supply voltage	24 V $\overline{--}$		
Voltage limits	17–33 V $\overline{--}$		
Current consumption	80 mA		
Output	—	Programmable, NPN or PNP, and NO or NC	
Time delay	—	Adjustable time delay on trip and on reset from 0 to 50 s, in increments of 1 s	
Switching capacity	—	200 mA	
Analog output	4–20 mA or 0–10 V, depending on the model. Maximum signal level adjustable between 300 and 500 bar (4350 and 7250 psi)		
Electrical connection	M12, 4-pin male connector. For suitable female connectors, including pre-wired versions, see page 64		

(1) Pressure sensors with adjustable differential for regulation between 2 thresholds. Solid-state and analog outputs.
(2) Fluids controlled: hydraulic oils, fresh water, sea water, air, corrosive fluids, from –15 to +80 °C (5 to 176 °F). Component materials of units in contact with the fluid: see page 36.

Curves

Analog output curve	Pressure sensor operating curves
---------------------	----------------------------------

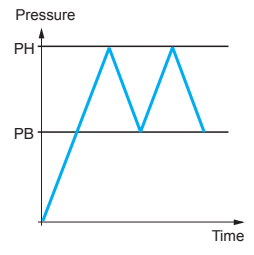
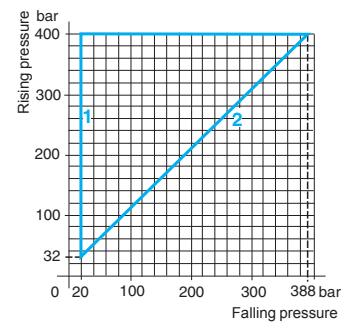
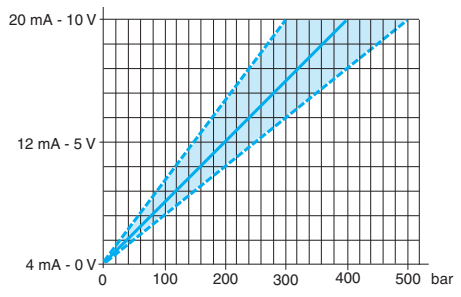

1 Maximum differential
2 Minimum differential
— Adjustable value

Type	Pressure switches with adjustable differential and relay output (1)	Dual stage adjustable pressure switches with solid-state outputs (2)
------	---	--

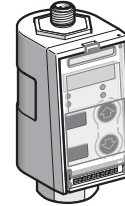
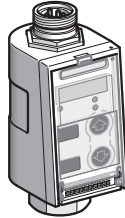

Adjustable range of switching point(s) (PH or PH1 and PH2) (Rising pressure) 32–400 bar (464–5800 psi)

Catalog Numbers

Fluid connection (3)	1/4" BSP female	XMLF400E2045	XMLF400D2035
	1/4" NPT female	XMLF400E2046	XMLF400D2036
	SAE 7/16-20UNF female	—	XMLF400D2039
Weight, g (oz)		700 (24.69)	590 (20.81)

Additional specifications not shown under general specifications (page 36)

Possible differential (subtract from: – PH to get PB – PH1 & PH2 to get PB1 & PB2)	Min. at low and high setting	12 bar (174 psi)	For each stage: min. at low and high setting: 12 bar (174 psi) max. at high setting: 380 bar (5510 psi)
	Max. at high setting	380 bar (5510 psi)	
Maximum permissible accidental pressure		1200 bar (17,400 psi)	
Destructive pressure		1800 bar (26,100 psi)	
Rated supply voltage		120 V~	24 V---
Voltage limits		102–132 V~	17–33 V---
Current consumption		32 mA	80 mA
Output		Relay	Programmable, NPN or PNP, and NO or NC
Time delay		Adjustable time delay on trip and on reset from 0 to 50 s, in increments of 1 s	
Switching capacity		2.5 A, AC-15, C300 (120 V / 1.5 A)	200 mA
Electrical connection		SAE 7/8-16UN, 5-pin male connector. For suitable female pre-wired connectors, see page 64	M12, 4-pin male connector. For suitable female connectors, including pre-wired versions, see page 64

- (1) Pressure switches with adjustable differential for regulation between 2 thresholds. Relay output.
- (2) Pressure switches with 2 adjustable stages and adjustable differential for each threshold. Solid-state outputs.
- (3) Fluids controlled: hydraulic oils, fresh water, sea water, air, corrosive fluids, from –15 to +80 °C (5 to 176 °F). Component materials of units in contact with the fluid: see page 36.

Pressure switch operating curves

(Curve for each stage for dual stage pressure switches) Pressure switches with relay output Dual stage pressure switches

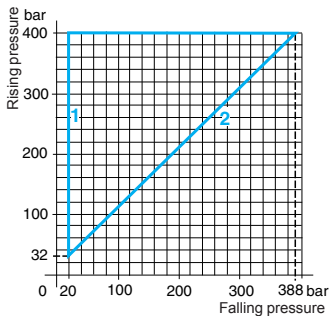

- 1 Maximum differential
- 2 Minimum differential

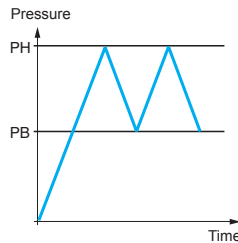

— Adjustable value

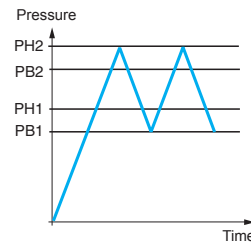

— Adjustable value

OsiSense® XML

Electronic pressure sensors
XMLF pressure sensors
Size: 600 bar (8700 psi)

Type	Pressure transmitters	Universal sensors with adjustable differential. Solid-state and analog outputs (1)
------	-----------------------	--

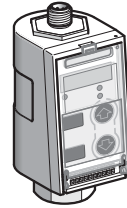

Adjustable range of switching point (PH) (Rising pressure)	—		48–600 bar (696–8700 psi)	
Analog output	4–20 mA	0–10 V	4–20 mA	0–10 V

Catalog Numbers

Fluid connection	1/4" BSP female	XMLF600D2015	XMLF600D2115	XMLF600D2025	XMLF600D2125
(2)	1/4" NPT female	XMLF600D2016	XMLF600D2116	XMLF600D2026	XMLF600D2126
Weight, g (oz)	590 (20.81)				

Additional specifications not shown under general specifications (page 36)

Possible differential (subtract from PH to give PB)	Min. at low and high setting	—	18 bar (261 psi)
	Max. at high setting	—	570 bar (8265 psi)
Maximum permissible accidental pressure	1200 bar (17,400 psi)		
Destructive pressure	1800 bar (26,100 psi)		
Rated supply voltage	24 V $\overline{--}$		
Voltage limits	17–33 V $\overline{--}$		
Current consumption	80 mA		
Output	—		
Time delay	—		
Switching capacity	—		
Analog output	4–20 mA or 0–10 V, depending on the model. Maximum signal level adjustable between 450 and 750 bar (6525 and 10 875 psi)		
Electrical connection	M12, 4-pin male connector. For suitable female connectors, including pre-wired versions, see page 64		

- (1) Pressure sensors with adjustable differential for regulation between 2 thresholds. Solid-state and analog outputs.
(2) Fluids controlled: hydraulic oils, fresh water, sea water, air, corrosive fluids, from –15 to +80 °C (5 to 176 °F). Component materials of units in contact with the fluid: see page 36.

Curves

Analog output curve

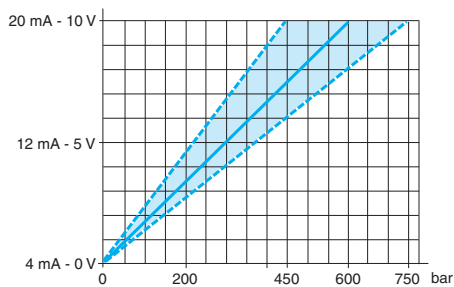

Pressure sensor operating curves

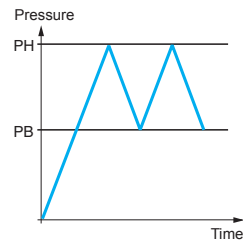
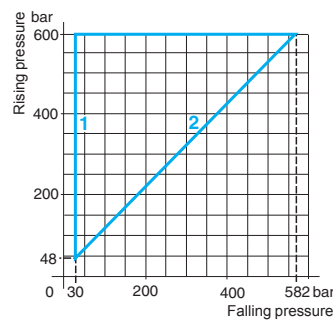

- 1 Maximum differential
2 Minimum differential

— Adjustable value

Type	Pressure switches with adjustable differential and relay output (1)	Dual stage adjustable pressure switches with solid-state outputs (2)
------	---	--

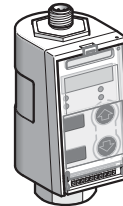
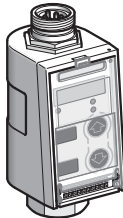

Adjustable range of switching point(s) (PH or PH1 and PH2) (Rising pressure)	48–600 bar (696–8700 psi)
--	---------------------------

Catalog Numbers

Fluid connection (3)	1/4" BSP female	XMLF600E2045	XMLF600D2035
	1/4" NPT female	XMLF600E2046	XMLF600D2036
Weight, g (oz)		700 (24.69)	590 (20.81)

Additional specifications not shown under general specifications (page 36)

Possible differential (subtract from: – PH to get PB – PH1 & PH2 to get PB1 & PB2)	Min. at low and high setting Max. at high setting	18 bar (261 psi) 570 bar (8265 psi)	For each stage: min. at low and high setting: 18 bar (261 psi) max. at high setting: 570 bar (8265 psi)
Maximum permissible accidental pressure		1200 bar (17,400 psi)	
Destructive pressure		1800 bar (26,100 psi)	
Rated supply voltage		120 V~	24 V~
Voltage limits		102–132 V~	17–33 V~
Current consumption		32 mA	80 mA
Output		Relay	Programmable, NPN or PNP, and NO or NC
Time delay		Adjustable time delay on trip and on reset from 0 to 50 s, in increments of 1 s	
Switching capacity		2.5 A, AC-15, C300 (120 V / 1.5 A)	200 mA
Electrical connection		SAE 7/8-16UN, 5-pin male connector. For suitable female pre-wired connectors, see page 64	M12, 4-pin male connector. For suitable female connectors, including pre-wired versions, see page 64

- (1) Pressure switches with adjustable differential for regulation between 2 thresholds. Relay output.
- (2) Pressure switches with 2 adjustable stages and adjustable differential for each threshold. Solid-state outputs.
- (3) Fluids controlled: hydraulic oils, fresh water, sea water, air, corrosive fluids, from –15 to +80 °C (5 to 176 °F). Component materials of units in contact with the fluid: see page 36.

Pressure switch operating curves

(Curve for each stage for dual stage pressure switches)	Pressure switches with relay output	Dual stage pressure switches
---	-------------------------------------	------------------------------

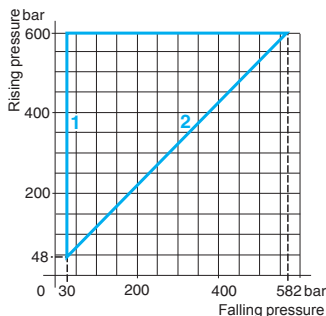

- 1 Maximum differential
- 2 Minimum differential

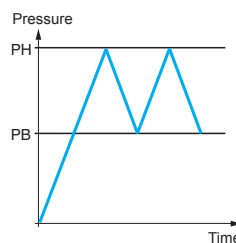

— Adjustable value

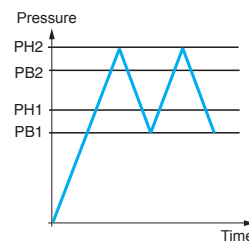

— Adjustable value

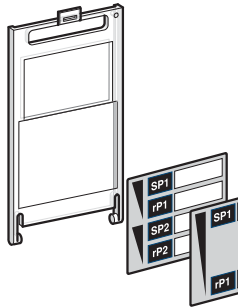

XMLZL007



XMLZL009



XMLZL010



XMLZL008

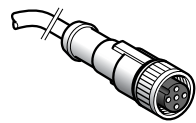

XZCP1141L●

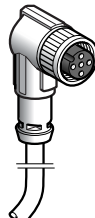

XZCP1241L●

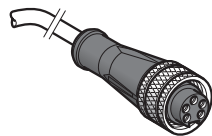

XZCP1764L●



XZCC12FDM40V

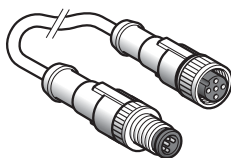

XZCR1511041C●

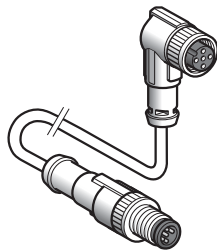

XZCR1512041C●

Catalog Numbers

Replacement parts

Description	Catalog number	Weight g (oz)
Transparent cover with legends	XMLZL007	20 (0.71)
Sealing gasket All sizes (XMLF)	XMLZL010	15 (0.53)

Accessories

Description	Catalog number	Weight g (oz)
Fixing bracket	XMLZL008	37 (1.31)
Cooler for versions with 1/4" BSP fluid connection (2) Usage temperature: 150 °C (302 °F) max. for the fluid, 50 °C (122 °F) for the ambient air	XMLZL009	370 (13.05)

Connectors

Description	Length of cable m (ft)	Catalog number	Weight g (oz)
Pre-wired M12, straight, female connectors (Black PVR)	2 (6.6)	XZCP1141L2	115 (4.06)
	5 (16.4)	XZCP1141L5	270 (9.52)
	10 (32.8)	XZCP1141L10	520 (18.34)
Pre-wired M12, straight, female connectors (Yellow PVC)	2 (6.6)	XSZCD101Y	90 (3.17)
	5 (16.4)	XSZCD102Y	190 (6.70)
	10 (32.8)	XSZCD103Y	370 (13.05)
Pre-wired M12, 90°, female connectors	2 (6.6)	XZCP1241L2	115 (4.06)
	5 (16.4)	XZCP1241L5	270 (9.52)
	10 (32.8)	XZCP1241L10	520 (18.34)
Pre-wired 7/8" 16UN, straight, female connectors	2 (6.6)	XZCP1764L2	185 (6.53)
	5 (16.4)	XZCP1764L5	460 (16.23)
	10 (32.8)	XZCP1764L10	900 (31.75)
M12 straight, female connector (1)	—	XZCC12FDM40V	520 (18.34)
M12–M12 jumper cables with straight male connector, for splitter box	Straight female connector 1 (3.3)	XZCR1511041C1	65 (2.29)
	2 (6.6)	XZCR1511041C2	95 (3.35)
	90° female connector 1 (3.3)	XZCR1512041C1	65 (2.29)
	2 (6.6)	XZCR1512041C2	95 (3.35)

(1) Connector incorporating IDCs (insulation displacement connectors) for quick, direct, in-line connection to cable without a screwdriver or soldering iron.

(2) Available with other fluid connections (1/4" NPT and SAE 7/16-20 UNF).

Connections (pressure sensor connector pin view)

XMLF●●●D201●,
F●●●D211●

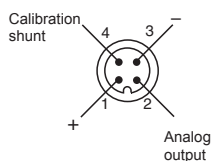

XMLF●●●D202●,
F●●●D212●

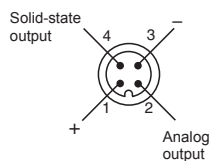

XMLF●●●D203●

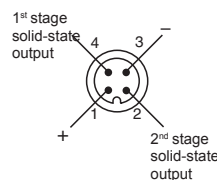

XMLF●●●E204●

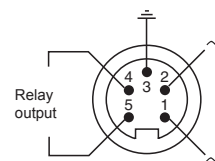

Dimensions, mm (in.)

XMLZL009

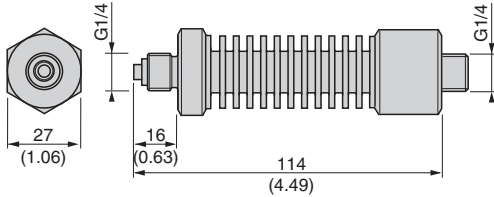

XMLF●●●D2●●●

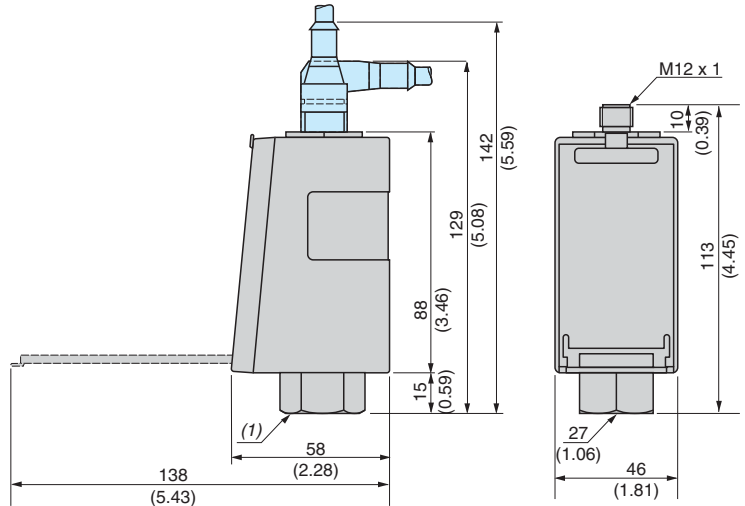

XMLZL008

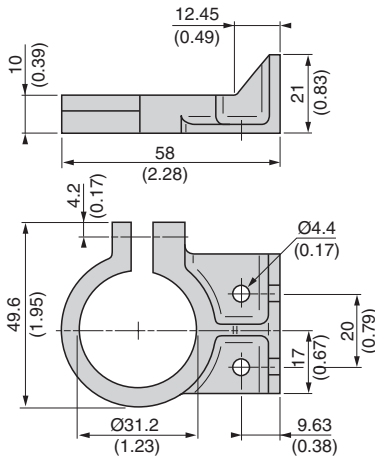

(1) Female fluid entry
XMLF●●●D2●●●5: G 1/4 A (BSP)
XMLF●●●D2●●●6: 1/4" NPT
XMLF●●●D2●●●9: SAE 7/16-20UNF

XMLF●●●E2●●●

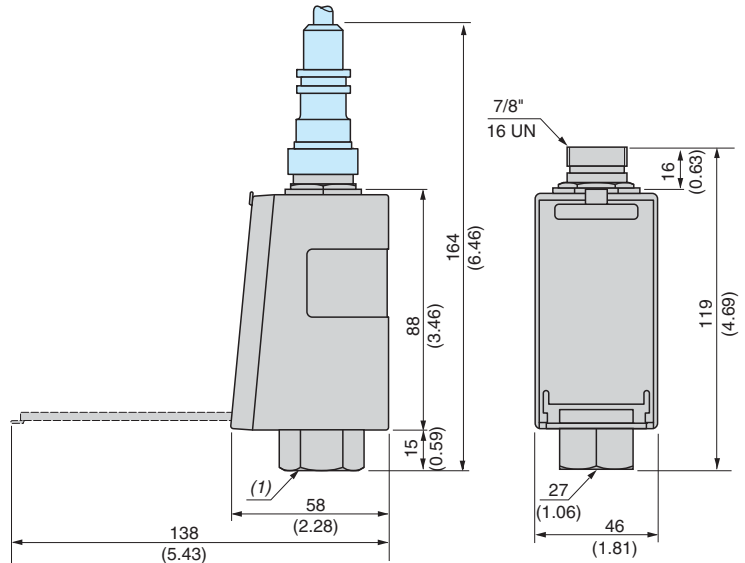

(1) Female fluid entry
XMLF●●●E2●●●5: G 1/4 A (BSP)
XMLF●●●E2●●●6: 1/4" NPT
XMLF●●●E2●●●9: SAE 7/16-20UNF

XMLZL010

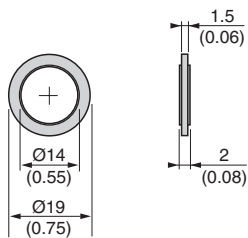

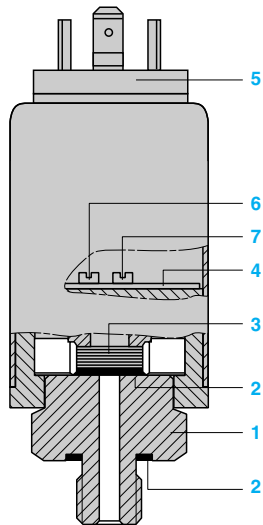

Introduction

XMLE pressure switches and pressure transmitters are characterized by their ceramic pressure measuring cell.

- 1 Threaded fluid entry.
- 2 Sealing gaskets.
- 3 Measuring load cell (ceramic technology).
- 4 Electronic card.
- 5 Electrical connector.
- 6 Adjustment potentiometer for switching point PH (rising pressure).
Only applicable to pressure switches.
- 7 Adjustment potentiometer for switching point PB (falling pressure).
Only applicable to pressure switches.

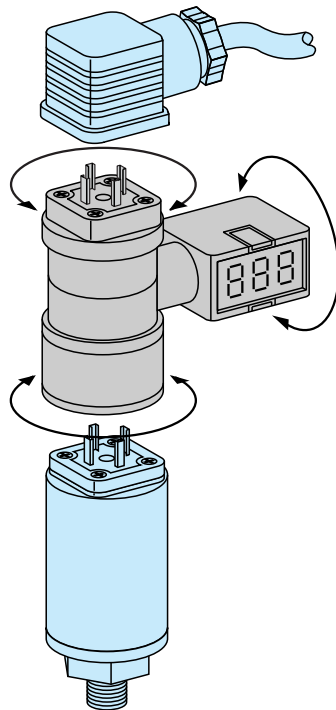

Operating principle

Pressure switches XMLE incorporate a solid-state NPN or PNP NC output. Two potentiometers enable the setting of the PH (rising pressure) and PB (falling pressure) switching points.

Pressure transmitters XMLE provide a 4–20 mA analog output which is proportional to the measuring range.

A digital display unit can be plugged in directly between the male and female DIN 43650A connectors.

Simple, unrestricted positioning of the display unit + sensor + connector is possible (can be rotated through 360°).

The display can be adjusted to enable reading from any direction (360° orientation both vertically and horizontally).

Specifications	
Conformity to standards	CE, EN 50081, EN 50082
Product certifications	UL, CSA
Protective treatment	Standard version "TC"
Ambient air temperature	For operation: -15 to +80 °C (5 to 176 °F)
Fluids or products controlled	Hydraulic oils, air, fresh water, sea water, corrosive fluids from -15 to +80 °C (5 to 176 °F)
Component materials in contact with fluid	Stainless steel fluid entry type AISI 303, Viton® gasket Ceramic pressure measuring cell
Operating position	All positions
Vibration resistance	5 gn (25–200 Hz) and 35 gn (60–2000 Hz)
Shock resistance	50 gn
Electrical protection	Protected against reverse polarity, short-circuit, and overload
Degree of protection	IP65 conforming to IEC/EN 60529
Operating rate	50 Hz
Response time	< 5 ms
Service life	> 10 million operating cycles
Drift	Zero point: < ± 0.03% of the measuring range/°C Sensitivity: < ± 15% of the measuring range/°C
Precision	< ± 0.3% of the measuring range
Fluid connection	1/4" NPT (male) conforming to NF E 03-004, ISO 7
Electrical connection	DIN 43650A or M12 connector

Interpretation of the Catalog Number—XMLE

XMLE	100	U1	D	2	3	
Units without display, 40 mm dia.	Rated pressure		Solid state, without scale	Electrical connection	Output	Fluid connection
Code	psi	bar				
M01	-14.5 to 0	-1 to 0		C: DIN 43650A D: M12 Q: Integrated quick connect	2: Analog 3: Solid state, NPN 4: Solid state, PNP	1: G 1/4 A (BSP male) 3: 1/4" NPT male 6: 1/4" NPTF female 7: 7/16-20 UNF male
001	0 to 14.5	0 to 1				
010	0 to 145	0 to 10				
025	0 to 362.5	0 to 25				
060	0 to 870	0 to 60				
100	0 to 1450	0 to 100				
250	0 to 3625	0 to 250				
600	0 to 8700	0 to 600				

NOTE: Use this table only to interpret the catalog number. Some combinations are not available.

OsiSense® XML

Electronic pressure sensors
 XMLE pressure transmitters without display (1)
 Sizes –1 to 25 bar (–14.5 to 362.5 psi)

Type With analog output, fluid connection 1/4" NPT male

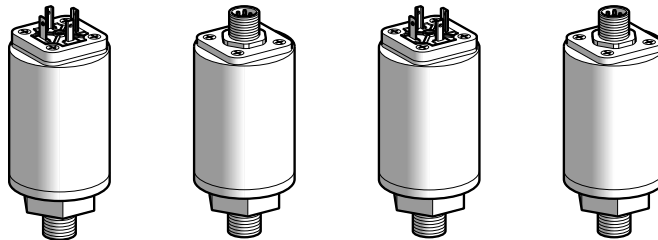

Pressure range	0 to –1 bar (0 to –14.5 psi)		0 to 1 bar (0 to 14.5 psi)	
Electrical connector type	DIN 43650A	M12	DIN 43650A	M12

Catalog Numbers

Fluids controlled (2)	Hydraulic oils, fresh water, sea water, air, corrosive fluids, from –15 to +80 °C (5 to 176 °F)	XMLEM01U1C23	XMLEM01U1D23	XMLE001U1C23	XMLE001U1D23
Weight, g (oz)		250 (8.82)	300 (10.58)	250 (8.82)	300 (10.58)

Additional specifications not shown under general specifications (page 67)

Maximum permissible accidental pressure	1 bar (14.5 psi)	2 bar (29 psi)
Destructive pressure	2 bar (29 psi)	3 bar (43.5 psi)
Rated supply voltage	24 V $\overline{--}$	
Voltage limits	11–33 V $\overline{--}$	
Output	Analog, 4–20 mA, 2-wire	
Current consumption	< 20 mA	
Electrical connection	XMLE●●●U1C●3: DIN 43650A, 4-pin male connector. For suitable female connector, see page 76. XMLE●●●U1D●3: M12, 5-pin male connector. For suitable female pre-wired connector, see page 76.	

(1) Optional digital display for sensor, see page 76.
 (2) Component materials of units in contact with the fluid: see page 67.

Output curves

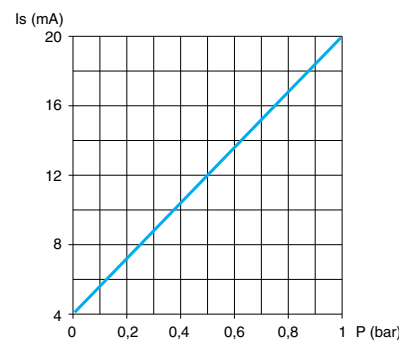
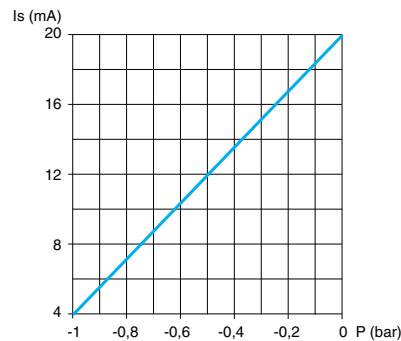

Other versions

For other fluid connections (such as G 1/4 A BSP male or 1/4" NPTF female), refer to "Interpretation of the Catalog Number" on page 67, or consult the Sensor Competency Center at 1-800-435-2121.

With analog output, fluid connection 1/4" NPT male

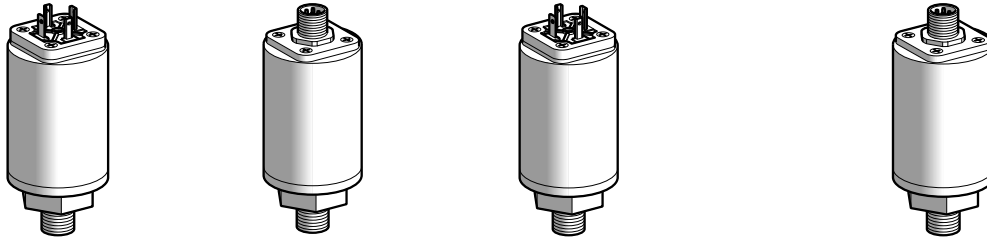

0–10 bar (0–145 psi)

DIN 43650A

M12

0–25 bar (0–362.5 psi)

DIN 43650A

M12

Catalog Numbers

XMLE010U1C23

XMLE010U1D23

XMLE025U1C23

XMLE025U1D23

250 (8.82)

300 (10.58)

250 (8.82)

300 (10.58)

Additional specifications not shown under general specifications (page 67)

20 bar (290 psi)

50 bar (725 psi)

30 bar (435 psi)

75 bar (1087.5 psi)

24 V $\overline{\text{--}}$

11–33 V $\overline{\text{--}}$

Analog, 4–20 mA, 2-wire

< 20 mA

XMLE●●●U1C23: DIN 43650A, 4-pin male connector. For suitable female connector, see page 76.

XMLE●●●U1D●3: M12, 5-pin male connector. For suitable female pre-wired connector, see page 76.

Output curves

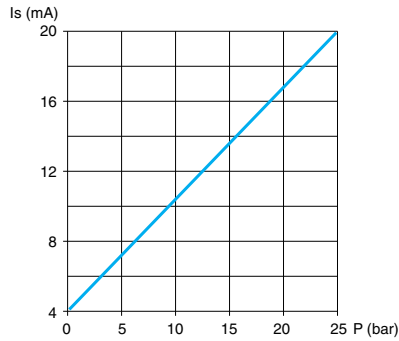
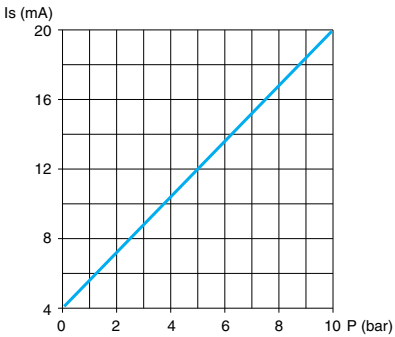

Type With analog output, fluid connection 1/4" NPT male

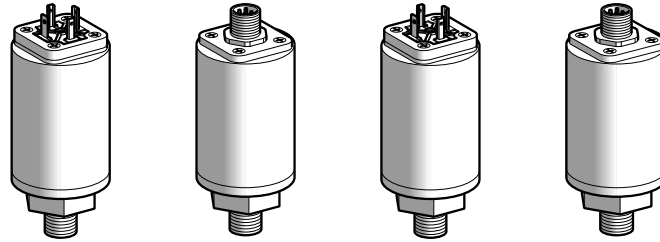

Pressure range	0–60 bar (0–870 psi)		0–100 bar (0–1450 psi)	
Electrical connector type	DIN 43650A	M12	DIN 43650A	M12

Catalog Numbers

Fluids controlled (2)	Hydraulic oils, fresh water, sea water, air, corrosive fluids, from –15 to +80 °C (5 to 176 °F)	XMLE060U1C23	XMLE060U1D23	XMLE100U1C23	XMLE100U1D23
		Weight, g (oz)	270 (9.52)	320 (11.29)	270 (9.52)

Additional specifications not shown under general specifications (page 67)

Maximum permissible accidental pressure	120 bar (1740 psi)	200 bar (2900 psi)
Destructive pressure	180 bar (2610 psi)	300 bar (4350 psi)
Rated supply voltage	24 V $\overline{--}$	
Voltage limits	11–33 V $\overline{--}$	
Output	Analog, 4–20 mA, 2-wire	
Current consumption	< 20 mA	
Electrical connection	XMLE●●●U1C●3: DIN 43650A, 4-pin male connector. For suitable female connector, see page 76. XMLE●●●U1D●3: M12, 5-pin male connector. For suitable female pre-wired connector, see page 76.	

(1) Optional digital display for sensor, see page 76.
 (2) Component materials of units in contact with the fluid: see page 67.

Output curves

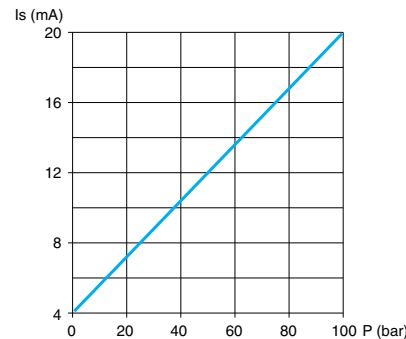
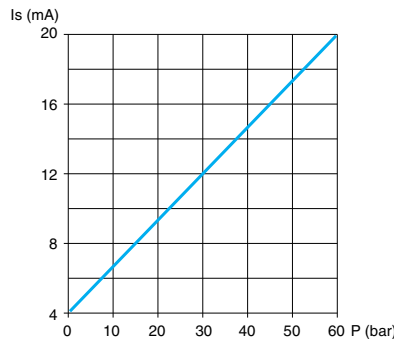

Other versions For other fluid connections (such as G 1/4 ABSP male or 1/4" NPTF female), refer to "Interpretation of the Catalog Number" on page 67, or consult the Sensor Competency Center at 1-800-435-2121.

With analog output, fluid connection 1/4" NPT male

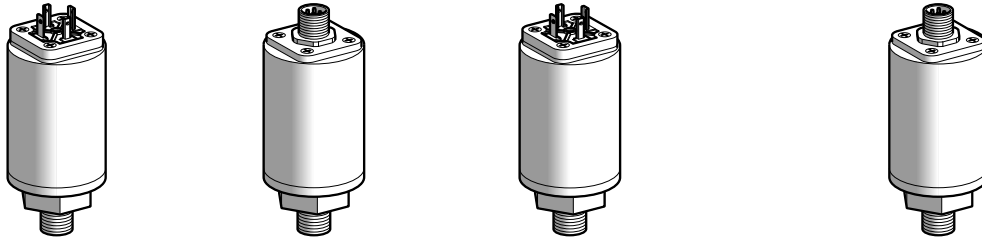

0–250 bar (0–3625 psi)

DIN 43650A

M12

0–600 bar (0–8700 psi)

DIN 43650A

M12

Catalog Numbers

XMLE250U1C23

XMLE250U1D23

XMLE600U1C23

XMLE600U1D23

270 (9.52)

320 (11.29)

270 (9.52)

320 (11.29)

Additional specifications not shown under general specifications (page 67)

500 bar (7250 psi)

1200 bar (17 400 psi)

750 bar (10 875 psi)

1800 bar (26 100 psi)

24 V_{DC}

11–33 V_{DC}

Analog, 4–20 mA, 2-wire

< 20 mA

XMLE●●●U1C23: DIN 43650A, 4-pin male connector. For suitable female connector, see page 76.

XMLE●●●U1D●3: M12, 5-pin male connector. For suitable female pre-wired connector, see page 76.

Output curves

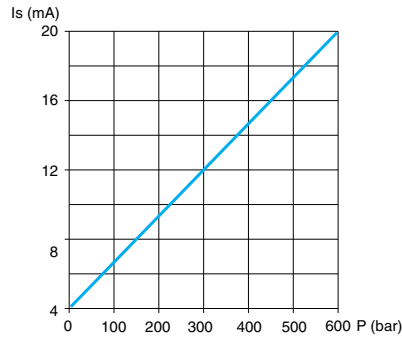
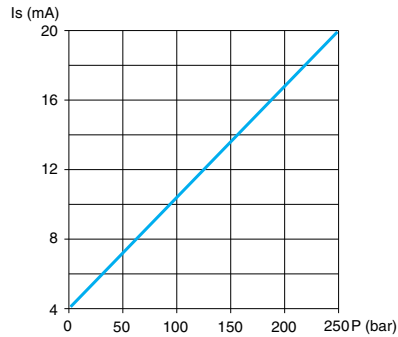

OsiSense® XML

Electronic pressure sensors
 XMLE pressure transmitters without display (1)
 for regulation between 2 thresholds
 Sizes –1 to 25 bar (–14.5 to 362.5 psi)

Type With solid-state output, fluid connection 1/4" NPT male

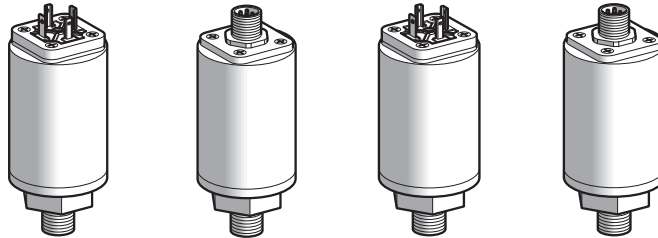

Adjustable range of switching point (PH) (Rising pressure) (2)	–0.07 to –1 bar (–1.015 to –14.5 psi)		0.07 to 1 bar (1.015 to 14.5 psi)	
Electrical connector type	DIN 43650A	M12	DIN 43650A	M12

Catalog Numbers

Fluids controlled (3)	Type of output	XMLEM01U1C33	XMLEM01U1D33	XMLE001U1C33	XMLE001U1D33
Hydraulic oils, fresh water, sea water, air, corrosive fluids, from –15 to +80 °C (5 to 176 °F)	NPN	XMLEM01U1C33	XMLEM01U1D33	XMLE001U1C33	XMLE001U1D33
	PNP	XMLEM01U1C43	XMLEM01U1D43	XMLE001U1C43	XMLE001U1D43
Weight, g (oz)		250 (8.82)	300 (10.58)	250 (8.82)	300 (10.58)

Additional specifications not shown under general specifications (page 67)

Possible differential	Min. at low setting	0.02 bar (0.29 psi)	0.02 bar (0.29 psi)
	Min. at high setting	0.02 bar (0.29 psi)	0.02 bar (0.29 psi)
	Max. at high setting	0.95 bar (13.77 psi) (max. differential at low setting)	0.95 bar (13.77 psi)
Maximum permissible accidental pressure	1 bar (14.5 psi)		2 bar (29 psi)
Destructive pressure	2 bar (29 psi)		3 bar (43.5 psi)
Rated supply voltage	24 V _{DC}		
Voltage limits	11–33 V _{DC}		
Output	Solid-state, NPN or PNP, NC		
Switching capacity	100 mA		
Current consumption	< 15 mA		
Electrical connection	XMLE●●●U1C●1: DIN 43650A, 4-pin male connector. For suitable female connector, see page 76. XMLE●●●U1D●1: M12, 4-pin male connector. For suitable female pre-wired connector, see page 76.		

(1) Optional digital display for pressure switch, see page 76.
 (2) For vacuum switches (size –1 bar): adjustable range of switching point (PB) on falling pressure.
 (3) Component materials of units in contact with the fluid: see page 67.

Operating curves

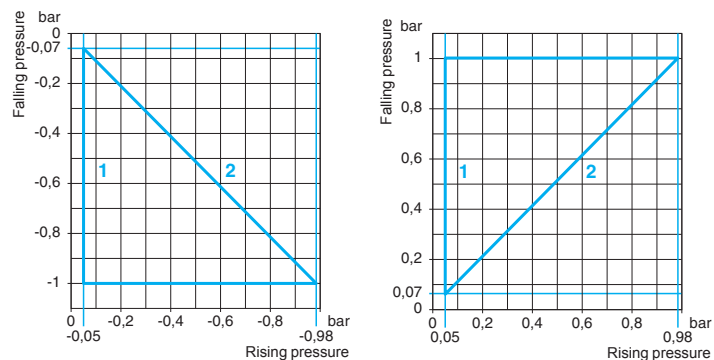

1 Maximum differential
 2 Minimum differential

Other versions For other fluid connections (such as G 1/4 ABSP male or 1/4" NPTF female), refer to "Interpretation of the Catalog Number" on page 67, or consult the Sensor Competency Center at 1-800-435-2121.

With solid-state output, fluid connection 1/4" NPT male

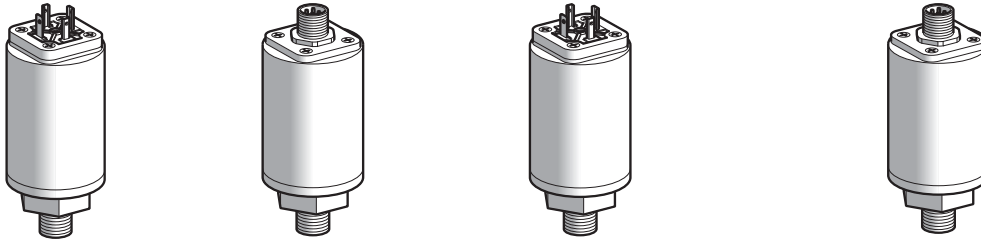

0.7–10 bar (10.15–145 psi)		1.75–25 bar (25.38–362.5 psi)	
DIN 43650A	M12	DIN 43650A	M12

Catalog Numbers

XMLE010U1C33	XMLE010U1D33	XMLE025U1C33	XMLE025U1D33
XMLE010U1C43	XMLE010U1D43	XMLE025U1C43	XMLE025U1D43
250 (8.82)	300 (10.58)	250 (8.82)	300 (10.58)

Additional specifications not shown under general specifications (page 67)

0.2 bar (2.9 psi)	0.2 bar (2.9 psi)
0.2 bar (2.9 psi)	0.2 bar (2.9 psi)
9.5 bar (137.7 psi)	23.75 bar (344.37 psi)
20 bar (290 psi)	50 bar (725 psi)
30 bar (435 psi)	75 bar (1087.5 psi)
24 V $\overline{--}$	
11–33 V $\overline{--}$	
Solid-state, NPN or PNP, NC	
100 mA	
< 15 mA	
XMLE●●●U1C●1: DIN 43650A, 4-pin male connector. For suitable female connector, see page 76.	
XMLE●●●U1D●1: M12, 5-pin male connector. For suitable female pre-wired connector, see page 76.	

Operating curves

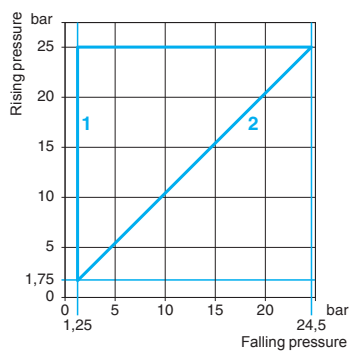
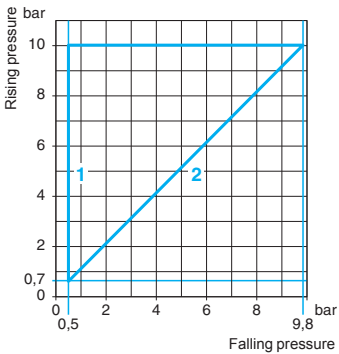

- 1 Maximum differential
- 2 Minimum differential

OsiSense® XML

Electronic pressure sensors
 XMLE pressure transmitters without display (1)
 for regulation between 2 thresholds
 Sizes 60 to 600 bar (870 to 8700 psi)

Type With solid-state output, fluid connection 1/4" NPT male

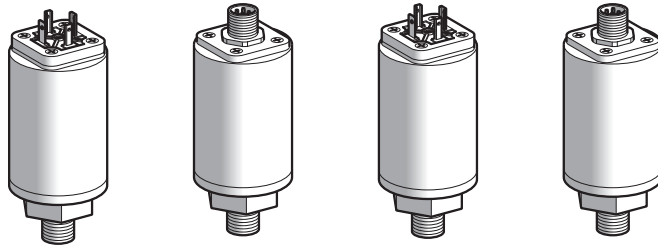

Adjustable range of switching point (PH) (Rising pressure)	4.2–60 bar (60.9–870 psi)		7–100 bar (101.5–1450 psi)	
Electrical connector type	DIN 43650A	M12	DIN 43650A	M12

Catalog Numbers

Fluids controlled (2)	Type of output				
Hydraulic oils, fresh water, sea water, air, corrosive fluids, from –15 to +80 °C (5 to 176 °F)	NPN	XMLE060U1C33	XMLE060U1D33	XMLE100U1C33	XMLE100U1D33
	PNP	XMLE060U1C43	XMLE060U1D43	XMLE100U1C43	XMLE100U1D43
Weight, g (oz)		270 (9.52)	320 (11.29)	270 (9.52)	320 (11.29)

Additional specifications not shown under general specifications (page 67)

Possible differential	Min. at low setting	1.2 bar (17.4 psi)	2 bar (29 psi)
	Min. at high setting	1.2 bar (17.4 psi)	2 bar (29 psi)
	Max. at high setting	57 bar (826.5 psi)	95 bar (1377.5 psi)
Maximum permissible accidental pressure		120 bar (1740 psi)	200 bar (2900 psi)
Destructive pressure		180 bar (2610 psi)	300 bar (4350 psi)
Rated supply voltage		24 V $\overline{-}$	
Voltage limits		11–33 V $\overline{-}$	
Output		Solid-state, NPN or PNP, NC	
Switching capacity		100 mA	
Current consumption		< 15 mA	
Electrical connection		XMLE●●●U1C●1: DIN 43650A, 4-pin male connector. For suitable female connector, see page 76. XMLE●●●U1D●1: M12, 5-pin male connector. For suitable female pre-wired connector, see page 76.	

(1) Optional digital display for pressure switch, see page 76.
 (2) Component materials of units in contact with the fluid: see page 67.

Operating curves

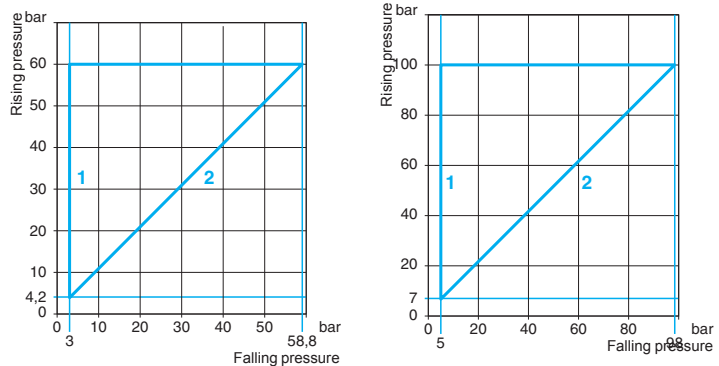

- 1 Maximum differential
- 2 Minimum differential

Other versions For other fluid connections (such as G 1/4 A BSP male or 1/4" NPTF female), refer to "Interpretation of the Catalog Number" on page 67, or consult the Sensor Competency Center at 1-800-435-2121.

With solid-state output, fluid connection 1/4" NPT male

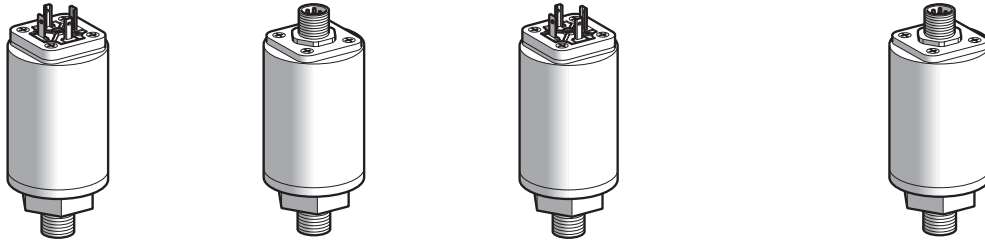

17.5–250 bar (253.7–3625 psi)

42–600 bar (609–8700 psi)

DIN 43650A

M12

DIN 43650A

M12

Catalog Numbers

XMLE250U1C33

XMLE250U1D33

XMLE600U1C33

XMLE600U1D33

XMLE250U1C43

XMLE250U1D43

XMLE600U1C43

XMLE600U1D43

270 (9.52)

320 (11.29)

270 (9.52)

320 (11.29)

Additional specifications not shown under general specifications (page 67)

5 bar (72.5 psi)

12 bar (174 psi)

5 bar (72.5 psi)

12 bar (174 psi)

237.5 bar (3443.7 psi)

570 bar (8265 psi)

500 bar (7250 psi)

1200 bar (17 400 psi)

750 bar (10 875 psi)

1800 bar (26 100 psi)

24 V $\overline{--}$

11–33 V $\overline{--}$

Solid-state, NPN or PNP, NC

100 mA

< 15 mA

XMLE●●●U1C●1: DIN 43650A, 4-pin male connector. For suitable female connector, see page 76.

XMLE●●●U1D●1: M12, 5-pin male connector. For suitable female pre-wired connector, see page 76.

Operating curves

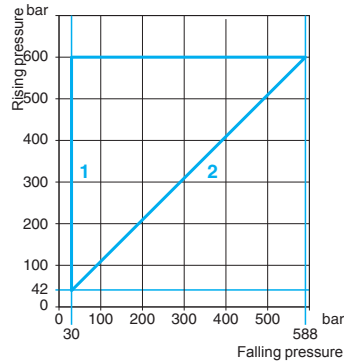
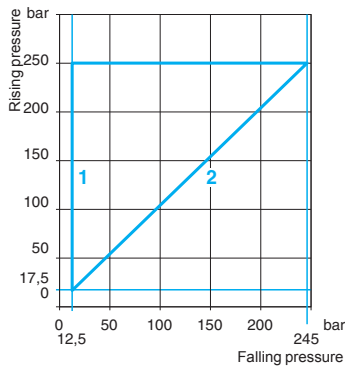

- 1 Maximum differential
- 2 Minimum differential

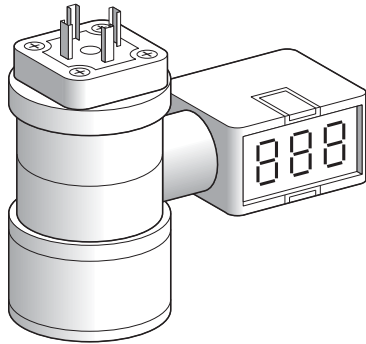

XMLEZ●●●●

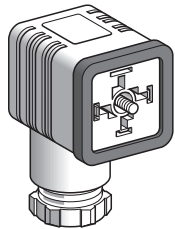

XZCC43FCP40B

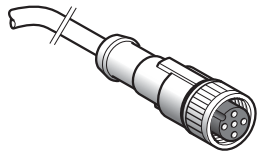

XZCP1164L●

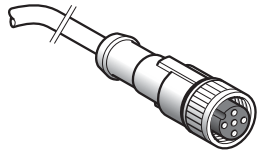

XZCP1164L●

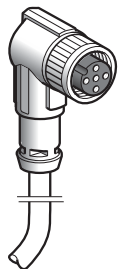

XZCP1264L●

Accessories

Description	Sensor size	Catalog number	Weight
Digital displays for analog pressure sensors	bar		g (oz)
	-1 to 0	XMLEZM01	100 (3.53)
	0 to 1	XMLEZ001	100 (3.53)
	0 to 10	XMLEZ010	100 (3.53)
	0 to 25	XMLEZ025	100 (3.53)
	0 to 60	XMLEZ060	100 (3.53)
	0 to 100	XMLEZ100	100 (3.53)
	0 to 250	XMLEZ250	100 (3.53)
	0 to 600	XMLEZ600	100 (3.53)

Connection accessories

Description	Length of cable	Catalog number	Weight
Female DIN 43650 A connector	m (ft)		g (oz)
	—	XZCC43FCP40B	35 (1.23)
DIN 43650 A, straight M12 male jumper cables for splitter boxes	1 (3.3)	XZCR1523062K1	80 (2.82)
	2 (6.6)	XZCR1523062K2	110 (3.88)
Pre-wired M12, straight, female connectors (Black PVR)	2 (6.6)	XZCP1164L2	115 (4.06)
	5 (16.4)	XZCP1164L5	270 (9.52)
	10 (32.8)	XZCP1164L10	520 (18.34)
Pre-wired M12, straight, female connectors (Yellow PVC) (1)	2 (6.6)	XSZCD1501Y	115 (4.06)
	5 (16.4)	XSZCD1502Y	270 (9.52)
	10 (32.8)	XSZCD1503Y	520 (18.34)
Pre-wired M12, 90°, female connectors	2 (6.6)	XZCP1264L2	115 (4.06)
	5 (16.4)	XZCP1264L5	270 (9.52)
	10 (32.8)	XZCP1264L10	520 (18.34)

(1) Note that the yellow PVC cables have a gray wire attached to pin 5—ground, whereas the black PVR cables have a yellow/green wire attached to pin 5—ground.

Dimensions, mm (in.)

XMLE●●●U1C23, XMLU1C33

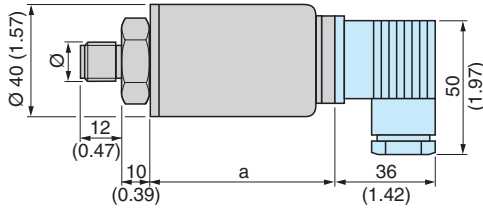

XMLE	a (1)
M01, 001, 010, 025	65 (2.56)
060, 250, 600	75 (2.95)

Ø: 1/4" NPT male

XMLE●●●U1D33

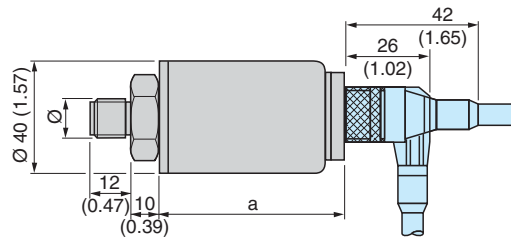

XMLE	a (1)
M01, 001, 010, 025	65 (2.56)
060, 250, 600	75 (2.95)

Ø: 1/4" NPT male

Digital displays

XMLEZ●●●

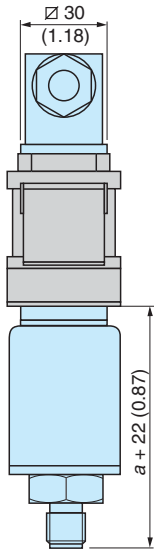

(1) For dimension "a", see table above.

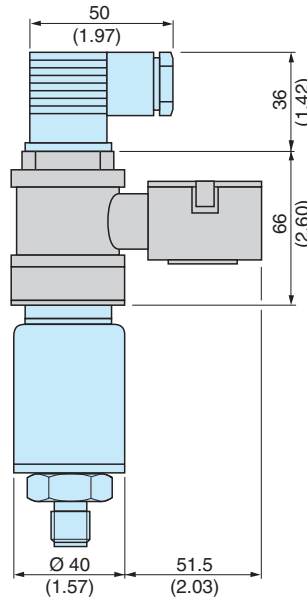

Wiring

Pressure transmitters (1)

XMLE●●●U1C23

XMLE●●●U1D●3

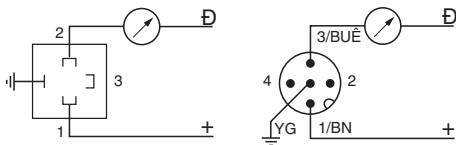

Electronic pressure switches (2)

XMLE●●●U1C33

XMLE●●●U1D33

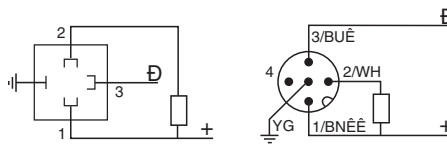

Jumper cables, DIN 43650 A, straight M12 male

XZCR15230D62K●

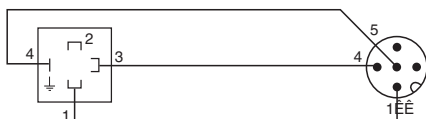

(1) sensor connector pin view

XMLE●●●U1C43

XMLE●●●U1D43

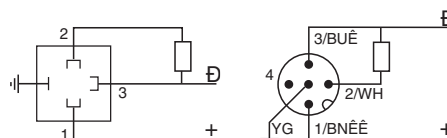

(2) switch connector pin view

Schneider Electric USA, Inc.

8001 Knightdale Blvd.
Knightdale, NC 27545
1-888-SquareD
1-888-778-2733

www.SchneiderElectric.com

The information and dimensions in this catalog are provided for the convenience of our customers. While this information is believed to be accurate, Schneider Electric reserves the right to make updates and changes without prior notification and assumes no liability for an errors or omissions.

9014CT0201R01/11 March 2011. Replaces 9014CT0201R8/07 dated November 2007.

© 2002–2011 Schneider Electric. All Rights Reserved.