

Control and signaling units

Harmony[®] XB4 metal

Catalog

July 2019



Quick access to product information

Get technical information about your product

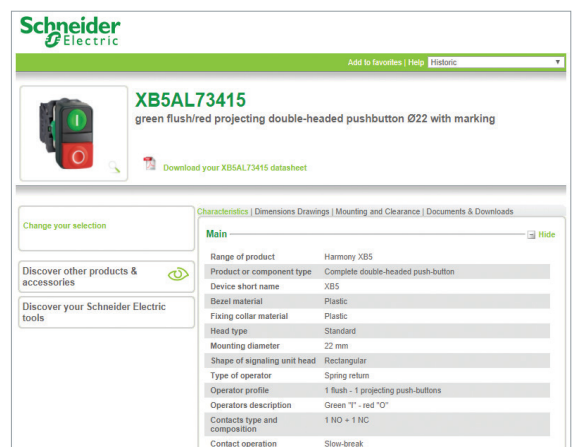

Each commercial reference presented in a catalog contains a hyperlink. Click on it to obtain the technical information of the product:

- Characteristics, Dimensions and drawings, Mounting and clearance, Connections and schemas, Performance curves
- Product image, Instruction sheet, User guide, Product certifications, End of life manual

Find your catalog

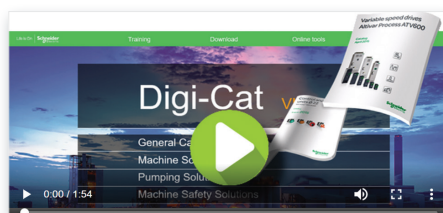

- > With just 3 clicks, you can reach the Industrial Automation and Control catalogs, in both English and French
- > Download Digi-Cat with this [link](#)

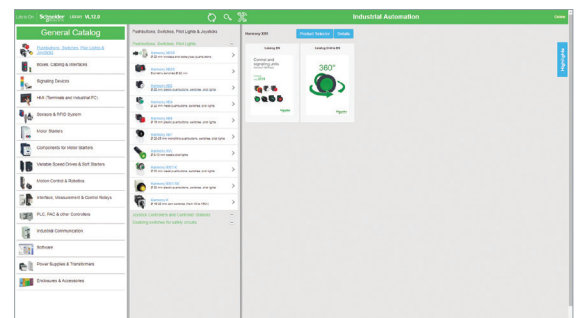

- Updated quarterly
- Embeds product selectors and configurators, 360 ° images, training centers,
- Optimized search by commercial reference

Select your training



- > Find the right [Training](#) for your needs on our Global website
- > Locate the training center with the selector tool, using this [link](#)

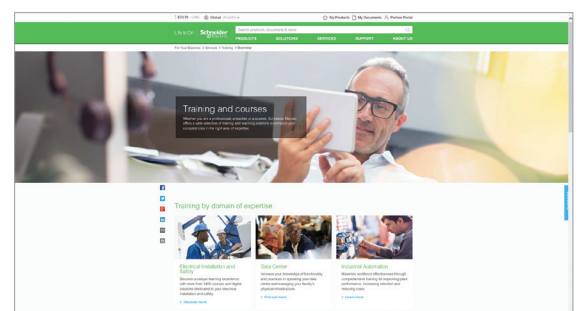

General contents

Harmony® XB4 metal

■ General presentation	page 2
■ Presentation	
□ Presentation, installation, and environment.....	page 10
■ Description	
□ Complete units, XB4B and XB4F.....	page 12
□ Sub-assemblies, ZB4B and ZB4F.....	page 16
■ Installation	
□ Contact mounting - Contact sequence.....	page 24
■ References	
□ Spring return pushbuttons, unmarked and with marking.....	page 26
□ Illuminated pushbuttons, spring return	
- With integral LED and BA 9s base fitting.....	page 30
□ Flush mounted spring return pushbuttons, unmarked and with marking.....	page 34
□ Flush mounted illuminated pushbuttons, spring return	
- With integral LED.....	page 37
□ Multiple-headed pushbuttons, spring return.....	page 40
□ Mushroom head pushbuttons, spring return and latching.....	page 42
□ Emergency stop and Emergency switching off functions.....	page 44
□ Illuminated rings and circular yellow legends for Emergency stop.....	page 45
□ Illuminated Emergency switching off function and circular yellow legends.....	page 47
□ Large head pushbuttons with integrated bellows.....	page 48
□ Pushbuttons and illuminated pushbuttons, push-push.....	page 50
□ Flush mounted pushbuttons with push-push, illuminated and non-illuminated.....	page 52
□ Selector switches	
- With standard handle and long handle.....	page 54
- Key switches, toggle switches, and with knurled knob.....	page 56
- Illuminated, with standard handle and integral LED.....	page 58
□ Flush mounted selector switches	
- With standard handle and long handle.....	page 60
- Key switches, and with knurled knob.....	page 62
- Illuminated, with standard handle and integral LED.....	page 64
□ Pilot lights	
- With integral LED and BA 9s base fitting.....	page 66
- Push-to-test pilot light.....	page 69
□ Flush mounted pilot light with integral LED.....	page 70
□ Specific functions	
- Manual overload reset pushbuttons, potentiometers.....	page 72
- Timers, hour counters, annunciators, USB/RJ45 ports, and fuse carrier.....	page 73
- Joystick controllers and wobblesticks.....	page 74
□ Contact and illuminated functions (blocks and bodies).....	page 76
□ Body/contact assemblies and light blocks	
- With integral LED and BA 9s base fitting.....	page 82
□ Accessories	
- For heads.....	page 89
- Legends and legend holders.....	page 92
- For pushbuttons.....	page 105
Selection guide	page 110
■ Product reference index	page 112

Control and signaling units

Pushbuttons, switches, and pilot lights



Life Is On

Schneider
Electric

Control and signaling units

Harmony XB4 metal

Pushbuttons, switches, and pilot lights

The Harmony XB4 range of metal pushbuttons, switches, and pilot lights combines simplicity of installation, flexibility, and robustness to meet the majority of industrial applications. It delivers one of the most comprehensive product ranges available on the market and meets the robustness and performance requirements for the majority of industrial applications.

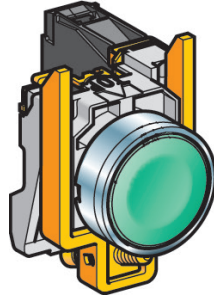

Complete unit for repetitive orders XB4BA31

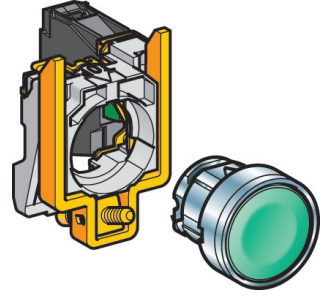

Sub-assembly (for additional flexibility) ZB4BZ101 + ZB4BA3

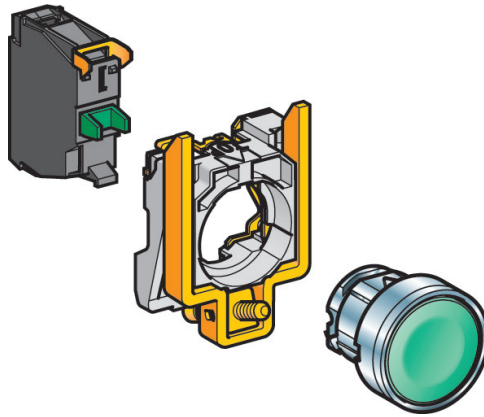

Basic elements (for optimum flexibility) ZBE101 + ZB4BZ009 + ZB4BA3



A global network of partners you can rely on to support customized end-to-end solutions

A single provider

Our team of experts understands the needs of our customers in terms of their processes and applications. The Harmony ranges are available globally wherever you need them.

The confidence of a market leader

- > More than 50 years' experience designing switches, pushbuttons, and pilot lights
- > A global network of partners and distributors you know and trust
- > Worldwide product availability with over 17,000 points of sale in more than 100 countries

Control and signaling units

Harmony XB4 metal

Pushbuttons, switches, and pilot lights

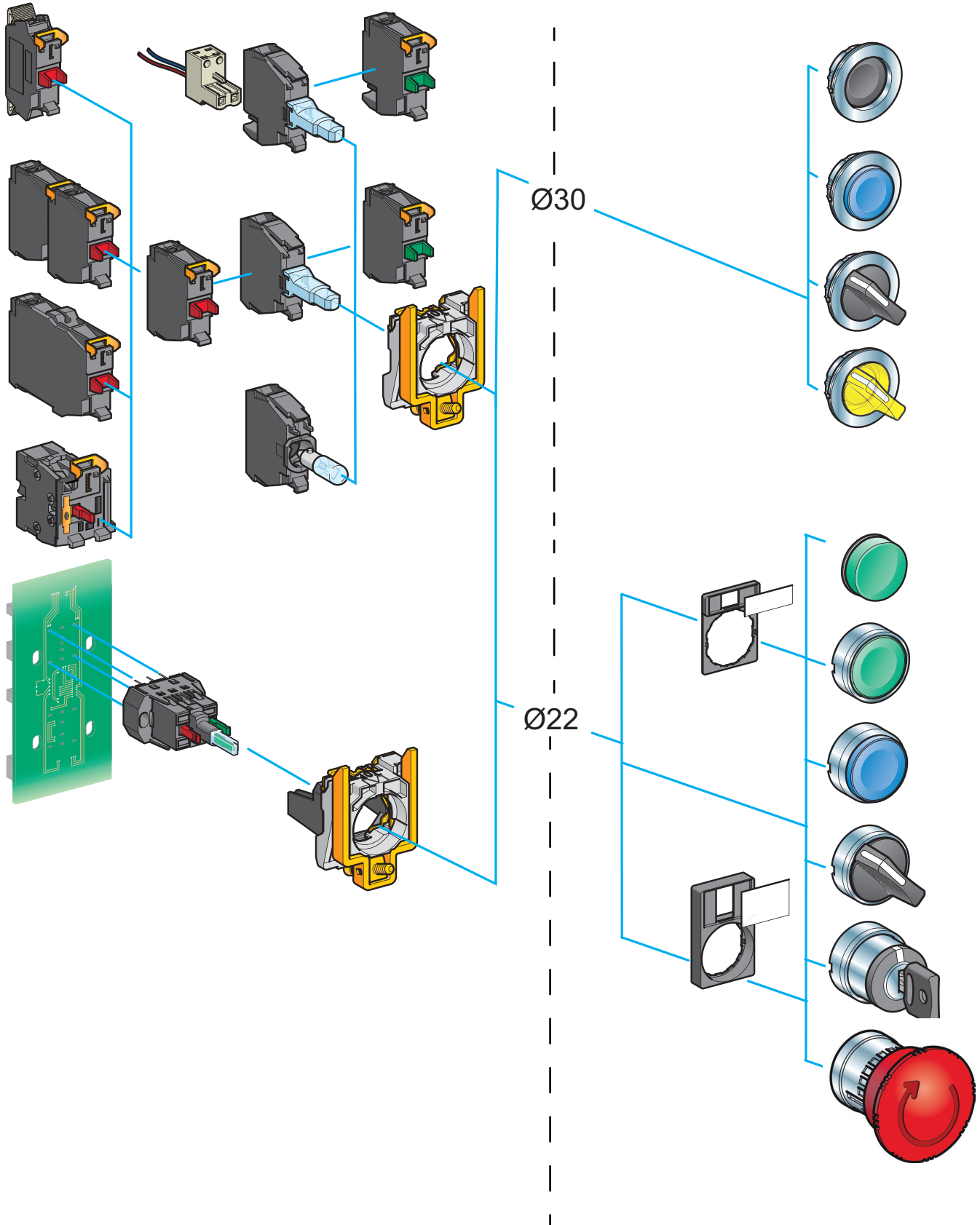

Modern design

Harmony delivers an innovative and ergonomic design that allows easy operation and improves the look and feel of your control panels and machines.

Improved reliability of panels, machines, and processes

- > The flush-mounting solution addresses the market demands for ergonomic design and aesthetics
- Built-in flush pushbuttons
- Flush mounting kit accessories
- > Pushbuttons and switches with a vibrant color palette

A touch of style for your electrical panels

- > Innovative design without compromise on cost
- > Better perceived quality of your machines and panels
- > A clearer view of control features

> Define your own style with powerful customization options

- > Markings on pushbutton, illuminated pushbuttons, and pilot lights caps
- > Markings on the bezel for all built-in flush products
- > Markings on accessories, like legend plates and legend panels

360° view
Click on the image for 3D view



Customized products



Operational efficiency

The Harmony XB4 range offers innovative features for ease-of-use to make an operator's work simpler and more efficient.



Emergency stop pushbutton with illuminated rings

Improved operator efficiency

- > Illuminated Emergency stop pushbutton solutions that help you quickly find the E-stop button responsible for the production downtime
- > Robust illuminated and non-illuminated buzzers providing water resistance up to IP66, IP67, IP69, and IP69K
- > High brightness and full-surface illumination of pushbuttons and selector switches
- > Dedicated offer for explosive atmospheres

Affordable

Harmony delivers simplicity and efficiency while helping to keep your costs down.

Faster, simpler installation and maintenance

- > Self-holding function of actuator when mounting
- > Timer for safe and simple adjustment of your machine's time settings
- > USB and RJ45 ports for a simple, effective way to connect a PC or USB
- > 3 phase pilot lights mounted in a single 30 mm (1.181 in.) diameter hole

Affordable range

Click to open video (33 sec)

Mounting options for easy access to functions on the front panel



USB port



RJ45 port



Timer



3-phase indicator



Complete potentiometer



Fuse carrier



Buzzer



Legend panel

Legend panels that help simplify installation

- > Hole positions are clearly identified and aligned on the legend panels
- > Just stick the legend panel on your operator interface surface and punch the hole where indicated
- > Save up to 75% of installation time compared with conventional hole alignment methods

Simple selection

Harmony XB4 delivers a comprehensive range of products that enable simple selection to help minimize your costs right from the beginning.

Web digital selector
Click to open the selector

Digital tools help you select the right product and customize it to meet your needs

- > Digi-Cat, for easy, up-to-date access to the PDF catalogs
- > Web digital selector to help you find the right reference for your application and customize your product.

Digi-Cat
Click to download Digi-Cat

Easy to convert from standard to flush mounted pushbuttons

- > Harmony XB4 pushbuttons offer the flexibility to convert from standard to flush mounting versions by simply changing a single letter in the product reference.

Example:

ZB4BA3



ZB4FA3

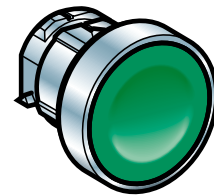

Standard
mounting

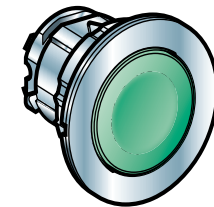

Flush
mounting

The secret of robustness
Click to open video (46 sec)

IP69 Robust performance
even in harsh
environments

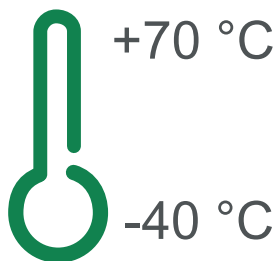

Marine environment
Click to open video (42 sec)

Robustness

Harmony XB4 delivers extremely robust performance even in severe environments.

Improved reliability of panels, machines, and processes

- > Sealing effectiveness rated up to IP66, IP67, IP68, IP69, IP69K, and type 4X
- > High impact resistance up to IK06 rating
- > Operating temperature ranging from -40 to +70 °C / -40 to +158 °F
- > Compliance with international standards (IEC, UL, CCC, EAC, JIS)
- > Marine certified (BV, LROS, BDNV, GL)

High electrical performance

- > Contacts and heads designed to prevent vibration, helping to ensure secure mounting and wiring
- Choose from standard, low-load, and high-power electrical contacts

Lower maintenance

- > Harmony pushbuttons are designed to perform up to 10 million operations.
- This represents more than 1,000 operations a day for 27 years.

Adapted to your applications, segments, and operating environments

Harmony offers a unique and unrivalled depth of range delivering products adapted to your applications, segments, and operating environments.



Material working



Packaging



Pumping



Consumer packaged goods



Water & waste water



Oil & Gas



Material handling

Control and signaling units

Harmony XB4, metal

Pushbuttons, switches, and pilot lights



Harmony XB4 range of control and signaling units for Ø 22 mm/0.866 in. mounting



Harmony XB flush mounted control and signaling units for Ø 30 mm/1.181 in mounting

Presentation

The Harmony® XB4 metal range of modular control and signaling units combines simplicity of installation, flexibility, and robustness. It meets the requirements of the majority of industrial applications. These units are either available as complete products or separate components for customer assembly.

This range includes:

- Pushbuttons, selector/key switches, Emergency stop functions, and multiple-headed pushbuttons designed for parameter settings, adjustments, and start/stop control of machines and installations
- Pilot lights, illuminated pushbuttons, illuminated selector switches, and illuminated Emergency stop functions designed for visual signaling
- Various accessories including:
 - Flush mounting kits:
 - redesigned, improving the look of the control panel
 - quick and easy installation in a 30.5 mm/1.20 in. hole making it compatible with 22 mm/0.87 in. devices
 - a cost-effective solution, as the control devices and the operating modes of the machine do not change
 - Other accessories: protective covers, legends and legend holders, pushbutton caps, boots, bulbs, etc.

The pushbutton and switch control offer (illuminated and non-illuminated) is both broad and comprehensive:

- Pushbuttons, spring return with flush push, projecting push, recessed push, booted flush push, or mushroom head
- Emergency stop pushbuttons with 3 types of head: push-pull, turn to release, and key release
- Pilot lights and illuminated pushbuttons with integral LED and BA 9s base fitting bulbs
- Selector switches with different types of operator: standard handle, long handle, knurled knob, or key
- Choice of heads: square, circular, rectangular, double-head/triple-head rectangular, or toggle
- Colors of push: white, black, green, orange, blue, red, or yellow
- Connection type: screw clamp connector, Faston connector, spring terminal, or for printed circuit board
- Contact blocks for general purpose or specific applications (low current, standard, or high power switching)
- Choice of heads to meet the majority of industrial needs: from the most basic pushbuttons and pilot lights, to functions meeting modern machine requirements, such as USB & RJ45 ports
- Wide choice of accessories and spare parts
- Other specific functions: complete potentiometer, hour counters, annunciator, or joystick controllers

Innovative complementary offers are also available:

- Control and signaling units for severe applications
- Wireless and batteryless pushbuttons
- Biometric switches

Control and signaling units

Harmony XB4, metal

Pushbuttons, switches, and pilot lights

Installation

Harmony XB4 products are both simple and quick to install:

- Mounting by single installer (self-maintaining head in its cut-out)
- Clip-together component system (head, body, contact blocks, and LED)
- Anti-loosening system for screw clamp terminals on contact blocks

Harmony XB4 standard mounting products are installed with or without a notch in a $\text{Ø} 22 \text{ mm}/0.866 \text{ in.}$ hole, thanks to the self-cleavable orientation pin.

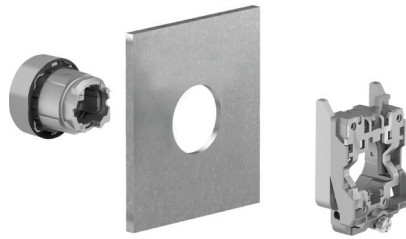

For installation of Harmony XB4 standard mounting products

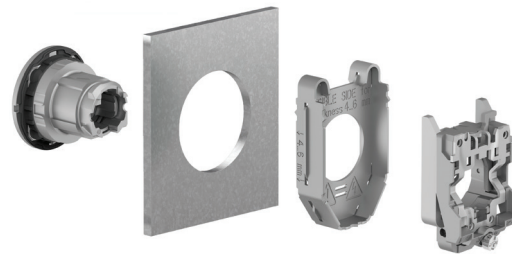

For installation of Harmony XB5 flush mounting products

Harmony XB4 flush mounting products are installed without a notch in a $\text{Ø} 30 \text{ mm}/1.181 \text{ in.}$ hole. This gives flush mounting products the same actuating area as that of standard mounting products, offering optimized ergonomics for operators even when wearing gloves.

Flush solutions mounted in a $\text{Ø} 22 \text{ mm}/0.866 \text{ in.}$ hole can be achieved using the Harmony XB6 range. Please refer to the Harmony XB6 catalog for details.

Environment

The performance of the Harmony XB4 range meets some of the most demanding international standards and approvals:

- Certified and approved for meeting requirements throughout all continents: EN/IEC, CE marking, UL, CSA, CCC, EAC, JIS, NEMA, and marine approvals
- Protection against ingress of solid objects, dust, and water: IP66, IP67, IP69, IP69K, type 4X
- Operating temperature range from -40 °C to $+70 \text{ °C}/-40 \text{ °F}$ to $+158 \text{ °F}$ for outdoor applications
- Shock protection level up to IK06
- High vibration resistance with shakeproof connection screws (periodic retightening unnecessary)

Control and signaling units



Harmony XB4, metal

Pushbuttons, switches, and pilot lights

Complete units, XB4B

Complete units

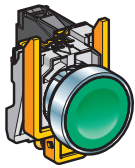
Contact functions

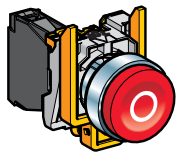
<p>Pushbuttons, spring return, with chromium plated metal bezel</p>	 <p>Flush push, unmarked XB4BA●1/BA42 see page 26</p>	 <p>Flush push, with marking XB4BA●3●● see page 29</p>	 <p>Projecting push, with marking XB4BL4325 see page 29</p>
---	--	---	--

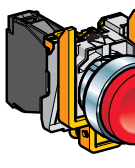
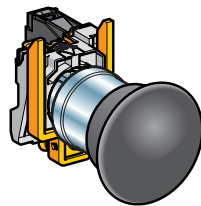
<p>Pushbuttons, spring return, with chromium plated metal bezel</p>	 <p>Booted flush push XB4BP●1/BP42 see page 28</p>	 <p>Projecting push, unmarked XB4BL42 see page 27</p>	 <p>Mushroom head XB4BC21 see page 42</p> <p>Ø 40 mm/ 1.57 in.</p>
---	---	--	---

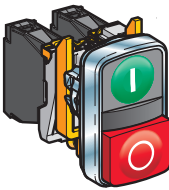
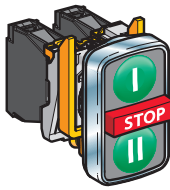
<p>Multiple-headed pushbuttons, spring return, with chromium plated metal bezel</p>	 <p>Double-headed XB4BL73415 see page 40</p>	 <p>Triple-headed XB4BA731327/XB4BA711237 see page 41</p>
---	---	--

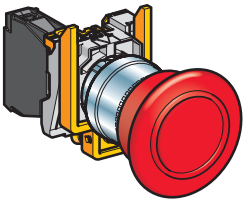
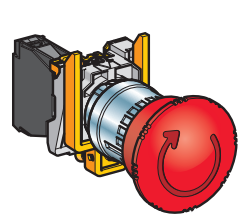
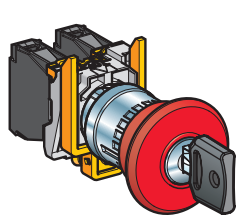
<p>Emergency stop or Emergency switching off mushroom head pushbuttons, Ø 40 mm/ 1.57 in., with chromium plated metal bezel</p>	 <p>Emergency stop trigger action and mechanical latching Push-pull (EN/ISO 13850) XB4BT845 see page 44</p>	 <p>Turn to release (EN/ISO 13850) XB4BS844● see page 44</p>	 <p>Key release (EN/ISO 13850) XB4BS9445 see page 44</p>
---	--	--	---

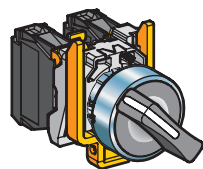
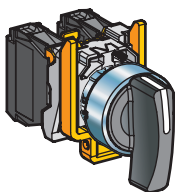
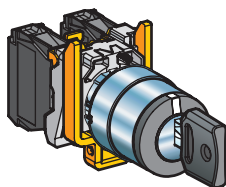
<p>Selector switches and key switches, with chromium plated metal bezel</p>	 <p>Standard handle, black XB4BD●● see page 54</p>	 <p>Long handle, black XB4BJ●● see page 55</p>	 <p>Key switch XB4BG●● see page 56</p>
---	---	---	---

References:
page 26

Control and signaling units

Harmony XB4, metal

Pushbuttons, switches, and pilot lights

Complete units, XB4B

Complete units

Signaling functions

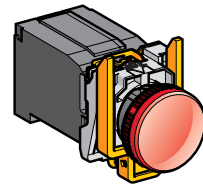
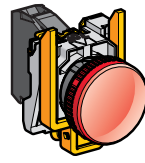
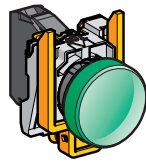

Pilot lights

Integral LED
XB4BV3●/BVG●/BVM●
see page 66

For bulb with BA 9s base fitting
Direct supply
XB4BV6●
see page 68

Via integral transformer with secondary
XB4BV3●/BV4●
see page 68

Combined functions (contact and signaling)

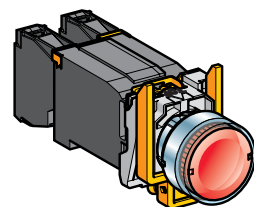
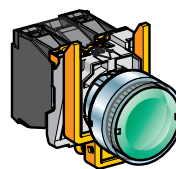
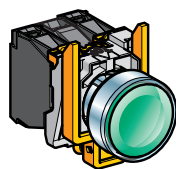

Illuminated pushbuttons,
spring return, flush push,
chromium plated metal bezel

Integral LED
XB4BW3●B5/BW3●G5/BW3●M5
see page 30

For bulb with BA 9s base fitting
Direct supply
XB4BW3●65
see page 33

Via integral transformer
XB4BW3●35/BW3●45
see page 33

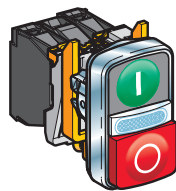

Double-headed pushbuttons
+ pilot light block, spring
return, chromium plated
metal bezel

Integral LED
XB4BW73731●5
see page 40

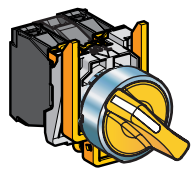

Illuminated selector switches
with standard handle,
chromium plated metal bezel

Integral LED
XB4BK12●5, XB4BK13●5
see page 58

Control and signaling units

Harmony XB4, metal

Pushbuttons, switches, and pilot lights

Complete units, XB4F flush mounting

Complete units

Contact functions for Ø 30 mm mounting

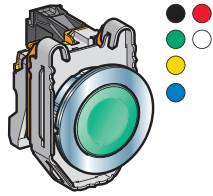

Pushbuttons, spring return, with chromium plated metal bezel

Flush push, unmarked
XB4FA●1/FA42
see page 34

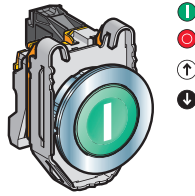

Flush push, with marking
XB4FA●3●●
see page 36

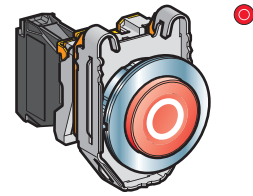

Projecting push, with marking
XB4FL4325
see page 36

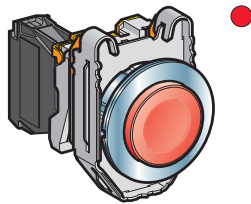

Pushbuttons, spring return, with chromium plated metal bezel

Projecting push, unmarked
XB4FL42
see page 35

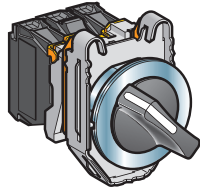

Selector switches and key switches, with chromium plated metal bezel

Standard handle, black
XB4FD●●
see page 60



Long handle, black
XB4FJ●●
see page 61

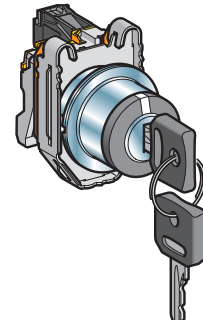

Key switch
XB4FG●●
see page 62

Complete units

Signaling functions for Ø 30 mm mounting



Pilot lights

Integral LED

XB4FVB●/FVG●/FVM●
see page 70

Combined functions (contact and signaling) for Ø 30 mm mounting

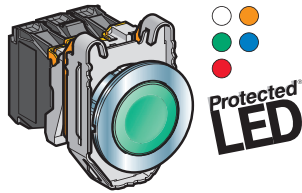

Illuminated pushbuttons, spring return, flush push, chromium plated metal bezel

Integral LED

XB4FW3●B5/FW3●G5/FW3●M5
see page 37

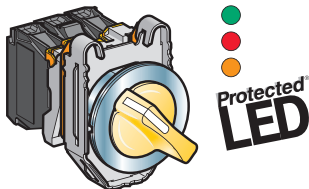

Illuminated selector switches with standard handle, chromium plated metal bezel

Integral LED

XB4FK12●●5, XB4FK13●●5
see page 64

Control and signaling units

Harmony XB4, metal

Pushbuttons, switches, and pilot lights

Sub-assemblies, ZB4B

Non illuminated units for user assembly

For pushbuttons, spring return, unmarked

Body sub-assemblies



Screw clamp terminals
ZB4BZ10/BZ141
see page 76

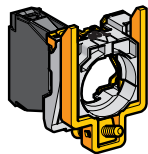

Faston
ZB4BZ10/3
see page 80

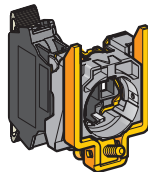

Spring clamp terminals
ZBE10/5
ZB4BZ10/5
see page 78

For pushbuttons, spring return, with marking

For multiple-headed pushbuttons, spring return

For "push-push to release" pushbuttons

Contact functions

Head sub-assemblies, chromium plated or black metal bezel



Flush push without cap
ZB4BA0
see page 26



Flush push with set of 6 caps
ZB4BA9
see page 26



Flush push
ZB4BA
see page 26

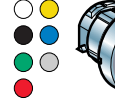

Flush push for insertion of legend
ZB4BA8
see page 26



Projecting push
ZB4BL
see page 27



Recessed push
ZB4BA6
see page 28



Booted flush/projecting push
ZB4BP/ BP/S
see page 28

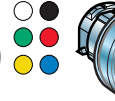

Booted flush push for insertion of legend
ZB4BP8
see page 28



Flush push
ZB4BA3/BA4
ZB4BA334/335
see page 29



Projecting push
ZB4BL3
see page 29



Double-headed pushbuttons
ZB4BA7
ZB4BA79
ZB4BL734
see page 40



Triple-headed pushbuttons
ZB4BA7313
ZB4BA711
ZB4BA72124
ZB4BA791
see page 41



Flush push
ZB4BH0
see page 50



Projecting push
ZB4BH
see page 50

Control and signaling units

Harmony XB4, metal

Pushbuttons, switches, and pilot lights

Sub-assemblies, ZB4B

Pilot lights for user assembly

Signaling functions

Body sub-assemblies with integral LED

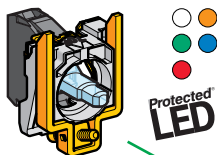

Connection: screw clamp terminals
ZB4BVJ●/BVB●/BVG●/ BVM●
 see page 84

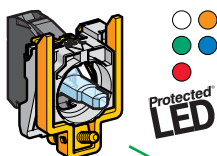

Connection: plug-in connector
ZB4VB●4/BVG●4/ BVM●4
 please contact our Customer Care Center

Head sub-assemblies

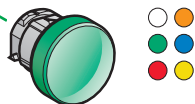

With lens fitted
ZB4BV0●3
 see page 67

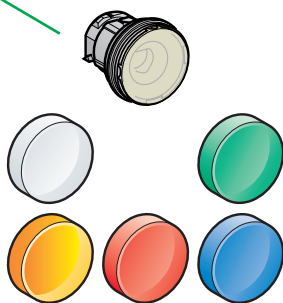

With 5 separate lenses, not fitted
ZB4BV003
 see page 67

Body sub-assemblies for BA 9s bulb



Direct supply
 Connection: screw clamp terminals
ZB4BV6
 see page 87

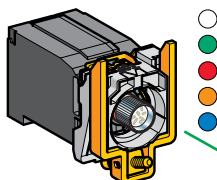

Via integral transformer
 Connection: screw clamp terminals
ZB4BV●D●
 see page 87

Head sub-assemblies



With lens fitted
ZB4BV0●, ZB4BV0●S
 see page 68

Control and signaling units

Harmony XB4, metal

Pushbuttons, switches, and pilot lights

Sub-assemblies, ZB4B

Illuminated pushbuttons for user assembly

For illuminated pushbuttons, spring return

Combined functions (contact and signaling)

Body sub-assemblies with integral LED

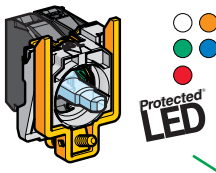

Screw clamp terminals
ZB4BW0B●●/BW0G●●/BW0M●●
see page 82

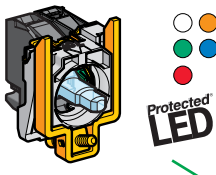

Plug-in connector
ZB4BW0B●●4
please contact our Customer Care Center

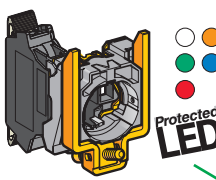

Spring clamp terminals
ZBV●●●
see page 78

For illuminated double-headed pushbuttons, spring return

For illuminated "push-push to release" pushbuttons and illuminated selector switches with standard handle

For illuminated mushroom head pushbuttons

For illuminated pushbuttons, spring return

Head sub-assemblies, chromium plated or black metal bezel

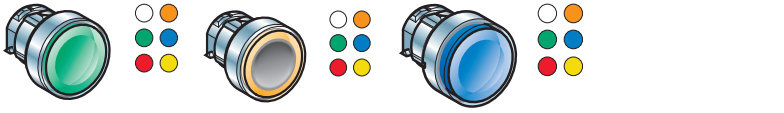

Flush push ZB4BW3●3 see page 31	Flush push with illuminated ring ZB4BW9●3 see page 31	Flush push for insertion of legend ZB4BA●8 see page 31
---------------------------------------	---	--

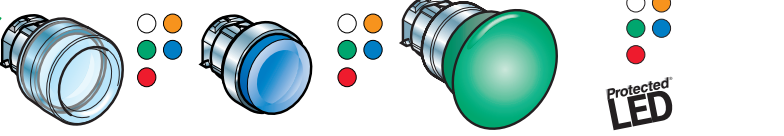

Booted flush push ZB4BW5●3 see page 31	Projecting push ZB4BW1●3, ZB4BW1●3S see page 32	Mushroom head, spring return ZB4BW4●3 see page 42
--	---	---



Double-headed (flush/flush push) + central pilot light
Double-headed (flush/projecting push) + central pilot light
ZB4BW7A17●● / ZB4BW7A374● / ZB4BW7A9, see page 40
ZB4BW7L374●, see page 40



Flush or projecting "push-push to release" ZB4BH0●3/BH●3 see page 51	Selector switches with standard handle ZB4BK1●●3 see page 59
--	--

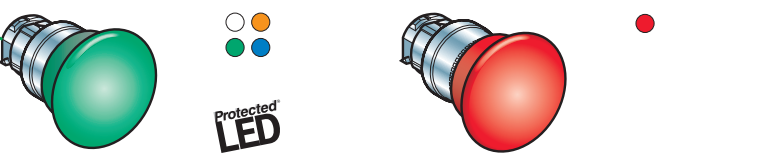

Mushroom head, latching ZB4BW6●3 see page 43	Emergency switching off, mechanical latching, push-pull ZB4BW643 see page 47
--	--

Body sub-assemblies for BA 9s bulb

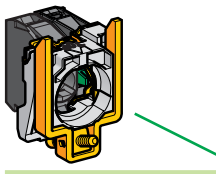

Direct supply or via integral transformer
Screw clamp terminals
ZB4BW0●●●
see page 86

Head sub-assemblies, chromium plated or black metal bezel

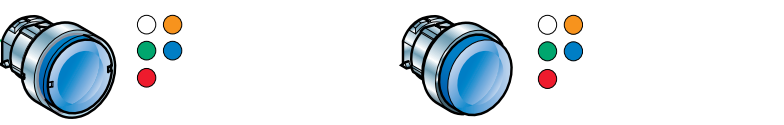

Flush push ZB4BW3●, ZB4BW3●S see page 33	Projecting push ZB4BW1●, ZB4BW1●S see page 33
--	---

Control and signaling units

Harmony XB4, metal

Pushbuttons, switches, and pilot lights

Sub-assemblies, ZB4F flush mounting heads

Non illuminated units for user assembly

Contact functions for Ø 30 mm mounting

For pushbuttons, spring return, unmarked

Body sub-assemblies



Screw clamp terminals
ZB4BZ10●/BZ141
see page 76

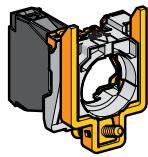

Faston
ZB4BZ10●3
see page 80

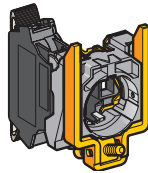

Spring clamp terminals
ZBE10●5
ZB4BZ10●5
see page 78

For pushbuttons, spring return, with marking

For "push-push to release" pushbuttons

Head sub-assemblies, chromium plated or black metal bezel

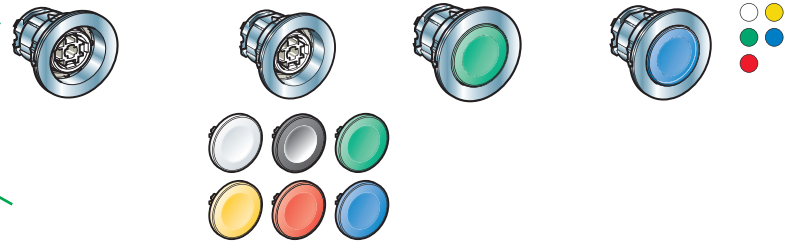

Flush push without cap
ZB4FA0
see page 34

Flush push with set of 6 caps
ZB4FA9
see page 34

Flush push
ZB4FA●
see page 34

Flush push for insertion of legend
ZB4FA●8
see page 34

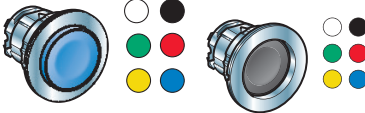

Projecting push
ZB4FL●
see page 35

Recessed push
ZB4FA●6
see page 34

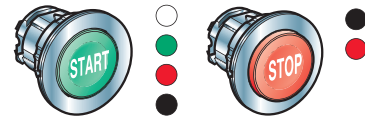

Flush push
ZB4FA●3●/FA●4●
ZB4FA334/335
see page 36

Projecting push
ZB4FL●3●
see page 36

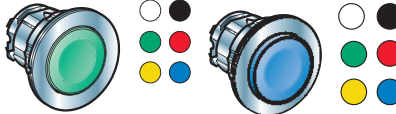

Flush push
ZB4FH0●
see page 52

Projecting push
ZB4FH●
see page 52

Control and signaling units

Harmony XB4, metal

Pushbuttons, switches, and pilot lights

Sub-assemblies, ZB4F flush mounting heads

Non illuminated units for user assembly (continued)

Contact functions for Ø 30 mm mounting

For selector switches and key switches

Body sub-assemblies

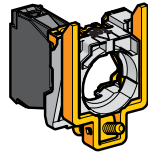

Screw clamp terminals
ZB4BZ10●/BZ141
see page 76

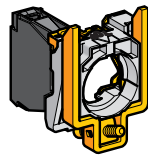

Faston
ZB4BZ10●3
see page 80

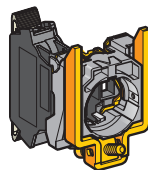

Spring clamp terminals
ZBE10●5
ZB4BZ10●5
see page 78

Head sub-assemblies, chromium plated or black metal bezel

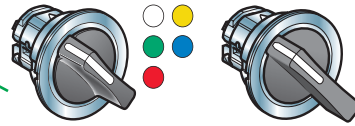

Standard black handle (1)
ZB4FD●
see page 60

Long black handle (1)
ZB4FJ●
see page 61

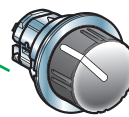

Knurled black knob (1)
ZB4FD●9
see page 63

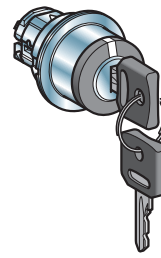

Key switch (2)
ZB4FG●●
see page 62

(1) Switch handle and knob positions

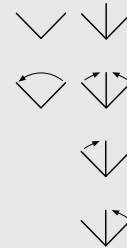

(2) Key switch positions
Key withdrawal positions

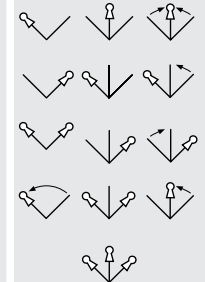

Control and signaling units

Harmony XB4, metal

Pushbuttons, switches, and pilot lights

Sub-assemblies, ZB4F flush mounting heads

Pilot lights for user assembly

Signaling functions for Ø 30 mm mounting

Body sub-assemblies with integral LED

Head sub-assemblies

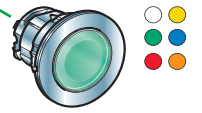
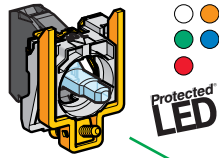

Connection: screw clamp terminals
ZB4BVJ●/BVB●/BVG●/BVM●
 see page 84

With lens fitted
ZB4FV0●3
 see page 71

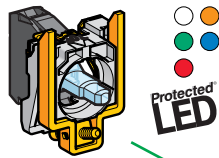

Connection: plug-in connector
ZB4VB●4/BVG●4/BVM●4
 please contact our Customer Care Center

Control and signaling units

Harmony XB4, metal

Pushbuttons, switches, and pilot lights

Sub-assemblies, ZB4F flush mounting heads

Illuminated pushbuttons for user assembly

For illuminated pushbuttons, spring return

For illuminated "push-push to release" pushbuttons and illuminated selector switches with standard handle

Combined functions (contact and signaling) for Ø 30 mm mounting

Body sub-assemblies with integral LED



Screw clamp terminals
ZB4BW0B●●/BW0G●●/BW0M●●
see page 82



Plug-in connector
ZB4BW0B●●4
please contact our Customer Care Center

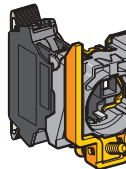

Spring clamp terminals
ZBV●●●
see page 78

Head sub-assemblies, chromium plated or black metal bezel

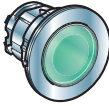

Flush push
ZB4FW3●3
see page 38

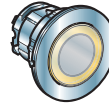

Flush push with illuminated ring
ZB4FW9●3
see page 38

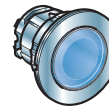

Flush push for insertion of legend
ZB4FA●8
see page 38

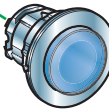

Projecting push
ZB4FW1●3
see page 39

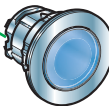

Flush or projecting "push-push to release"
ZB4FH0●3/FH●3
see page 53

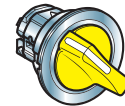

Selector switches with standard handle
ZB4FK1●●3
see page 65

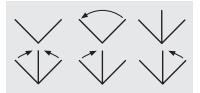

Control and signaling units

Harmony XB4 metal
Contact mounting - Contact sequence

Maximum recommended configurations to help ensure compliance with catalog characteristics

Unit type (complete units XB4B and XB4F, heads ZB4B and ZB4F)	Pushbuttons, spring return XB4BA●, ZB4BA●, XB4FA●, ZB4FA●, (except ZB4BA●8 and ZB4FA●8) XB4BC●, ZB4BC●, XB4BL●, ZB4BL●, XB4BP●, ZB4BP●, ZB4BR●, XB4FL●, ZB4FL●	Double-headed pushbuttons XB4BL73415, ZB4BA712●, ZB4B●734●, ZB4BA79	Illuminated pushbuttons, spring return XB4BW●, ZB4BW●, ZB4BA●8
	Triple-headed pushbuttons XB4BA731327, XB4BA711137, ZB4BA7313●, ZB4BA7111●, ZB4BA72124, ZB4BA791		Double-headed pushbuttons + pilot light block XB4BW73731●5, ZB4BW7A17●●, ZB4BW7●374●, ZB4BW7A9
Solution using single contacts			
Solution using single and double contacts			
Maximum recommended configurations	Single contacts Double contacts + single contacts Light block		
	9 3 + 3 -	6 2 + 2 -	6 2 + 2 1

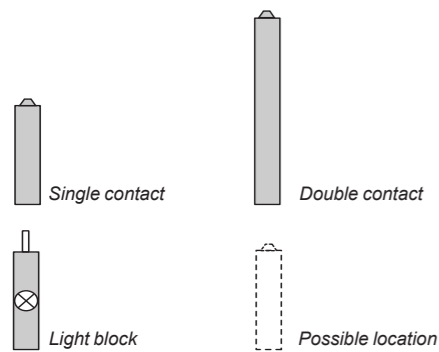

Possible configurations for high power switching contacts (1) (2)

High power switching contact blocks with screw clamp terminal connections:
ZBE501, ZBE502, ZBE503, ZBE504 and ZBE505
High power switching contact blocks with connection by Faston connectors:
ZBE5013, ZBE5023, ZBE5033, ZBE5043 and ZBE5053

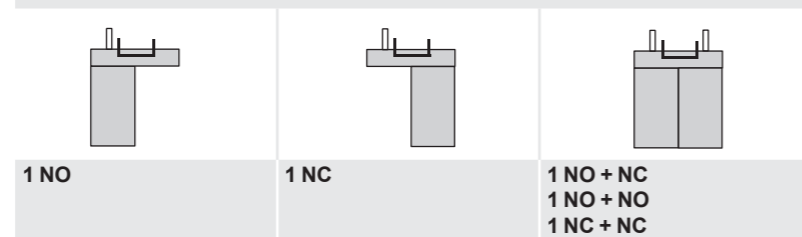

(1) The configurations are not upgradable and cannot be combined with other types of contact and signaling functions.
(2) High power switching contacts are not compatible with Harmony triple-headed pushbuttons.

Emergency stop or Emergency switching off







Emergency stop or Emergency switching off XB4BT●, ZB4BT●, XB4BS●, ZB4BS●	Selector switches ■ Standard handle XB4BD●, ZB4BD●, XB4FD●, ZB4FD● ■ Long handle XB4BJ●, ZB4BJ●, XB4FJ●, ZB4FJ● ■ Knurled knob ZB4BD●9, ZB4FD●9 ■ Key switch XB4BG●, ZB4BG●, XB4FG●, ZB4FG●	Illuminated selector switches, standard handle XB4BK●, ZB4BK●, XB4FK●, ZB4FK●	Toggle switches ZB4BD●8	Pushbuttons, push-push ZB4BH●, ZB4FH●	Illuminated pushbuttons, push-push ZB4BH●3, ZB4FH●3
4 2 + 0 -	4 1 + 2 -	5 2 + 1 -	4 1 + 2 -	6 2 + 0 1	3 - + 0 -

Sequence of contacts on selector switch bodies

Unit type	Selector switches	
	2-position	3-position
Push	Position	Top
		Bottom
	Location	L C R
	State	0 0 0 1 1 1
Contacts	NO	■ ■ ■ □ □ □
	NC	□ □ □ ■ ■ ■
		L C R L C R L C R
		1 1 0 0 0 0 0 1 1
		■ ■ ■ □ □ □ □ □ □
		□ □ □ ■ ■ ■ ■ □ □

L left, C center, R right
□ open ■ closed

Assembly of other products using:
 Body/contact assemblies: see page 76
 Accessories: see page 88

Pushbuttons with flush push (1)						
Screw clamp terminal connections (Schneider Electric anti-loosening system)						
Shape of head	Type of push	Type of contact		Color of push	Reference	Weight kg/lb
						
Complete units (2)						
	Flush	1	-	White	XB4BA11 (ZB4BZ101 + ZB4BA1)	0.080/0.176
				Black	XB4BA21 (ZB4BZ101 + ZB4BA2)	0.080/0.176
				Green	XB4BA31 (ZB4BZ101 + ZB4BA3)	0.080/0.176
				Yellow	XB4BA51 (ZB4BZ101 + ZB4BA5)	0.080/0.176
				Blue	XB4BA61 (ZB4BZ101 + ZB4BA6)	0.080/0.176
				Red	XB4BA42 (ZB4BZ102 + ZB4BA4)	0.080/0.176
Heads only						
	Without cap (3)		-	-	ZB4BA0	0.028/0.062
	Flush, with set of 6 colored caps		6 colors (4)		ZB4BA9	0.038/0.084
	Flush (2)		White		ZB4BA1	0.029/0.064
			Black		ZB4BA2	0.029/0.064
			Green		ZB4BA3	0.029/0.064
			Red		ZB4BA4	0.029/0.064
			Yellow		ZB4BA5	0.029/0.064
			Blue		ZB4BA6	0.029/0.064
			Gray		ZB4BA8	0.029/0.064
			White		ZB4BA18	0.028/0.062
			Green		ZB4BA38	0.028/0.062
			Red		ZB4BA48	0.028/0.062
	Flush with transparent cap for insertion of legend (5)		Yellow		ZB4BA58	0.028/0.062
			Blue		ZB4BA68	0.028/0.062
			6 colors		ZB4BA98	0.022/0.049
			White		ZB4BA14	0.034/0.075
			Black		ZB4BA24	0.034/0.075
			Green		ZB4BA34	0.034/0.075
	Flush (high bezel) (2)		Red		ZB4BA44	0.034/0.075
			Yellow		ZB4BA54	0.034/0.075
			Blue		ZB4BA64	0.034/0.075
			Blue		ZB4BA64	0.034/0.075

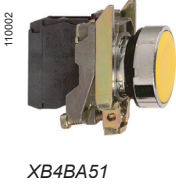

Heads with black metal bezel

To order, add a 7 to the references selected from above.
 Example: **ZB4BA0** becomes **ZB4BA07**.





(1) For recommended maximum number of contacts constituting the body (fixing collar and contact) associated with the head, see page 24.
 (2) To add customized markings on these references using the web customization tool, see page 5.
 (3) Colored cap to be ordered separately (see page 88).
 (4) Head supplied with 6 different colored caps (white, black, green, red, yellow, and blue) not fitted.
 (5) For legend ordering information, see page 98.

Assembly of other products using:
 Body/contact assemblies: see page 76
 Accessories: see page 88

Control and signaling units

Harmony XB4, metal

Spring return pushbuttons, unmarked

Pushbuttons with projecting push ⁽¹⁾ ⁽²⁾						
Screw clamp terminal connections (Schneider Electric anti-loosening system)						
Shape of head	Type of push	Type of contact		Color of push	Reference	Weight kg/lb
						
		NO	NC			
Complete units						
	Projecting	-	1	Red	XB4BL42 (ZB4BZ102 + ZB4BL4)	0.081/0.179
Heads only						
	Projecting			White	ZB4BL1	0.030/0.066
				Black	ZB4BL2	0.030/0.066
				Green	ZB4BL3	0.030/0.066
				Red	ZB4BL4	0.030/0.066
				Yellow	ZB4BL5	0.030/0.066
				Blue	ZB4BL6	0.030/0.066

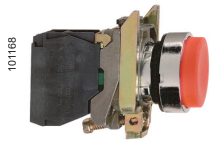

XB4BL42



ZB4BL1

(1) For recommended maximum number of contacts constituting the body (fixing collar and contact) associated with the head, see page 24.
 (2) To add customized markings on these references using the web customization tool, see page 5.

Assembly of other products using:
 Body/contact assemblies: see page 76
 Accessories: see page 88

Control and signaling units

Harmony XB4, metal

Spring return pushbuttons, unmarked

101197



ZB4BA36

Pushbuttons with recessed push (1) (2)					
High guard					
Shape of head	Type of push		Color	Reference	Weight kg/lb
Heads only					
	Recessed (high guard)		White	ZB4BA16	0.034/0.075
			Black	ZB4BA26	0.034/0.075
			Green	ZB4BA36	0.034/0.075
			Red	ZB4BA46	0.034/0.075
			Yellow	ZB4BA56	0.034/0.075
			Blue	ZB4BA66	0.034/0.075

110099

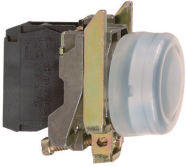

XB4BP21

Pushbuttons with silicone booted head for severe environments (1)						
Screw clamp terminal connections (Schneider Electric anti-loosening system)						
Shape of head	Type of push	Type of contact		Color of push	Reference	Weight kg/lb
		NO	NC			
Complete units (2)						
	Booted, clear silicone (color of push unobscured)	1	–	Black	XB4BP21 (ZB4BZ101 + ZB4BP2)	0.082/0.181
				Green	XB4BP31 (ZB4BZ101 + ZB4BP3)	0.082/0.181
				Yellow	XB4BP51 (ZB4BZ101 + ZB4BP5)	0.082/0.181
				Blue	XB4BP61 (ZB4BZ101 + ZB4BP6)	0.082/0.181
			–	1	Red	XB4BP42 (ZB4BZ102 + ZB4BP4)

110054



ZB4BP18

Silicone booted heads only, with increased protection (IP69K)					
	Flush	Clear boot (3) For insertion of protected legend within head (4)	White	ZB4BP18 (2)	0.034/0.075
			Green	ZB4BP38 (2)	0.034/0.075
			Red	ZB4BP48	0.034/0.075
			Yellow	ZB4BP58 (2)	0.034/0.075
			Blue	ZB4BP68	0.034/0.075
	Projecting	Clear boot (3) (2)	White	ZB4BP1	0.031/0.068
			Black	ZB4BP2	0.031/0.068
			Green	ZB4BP3	0.031/0.068
			Red	ZB4BP4	0.031/0.068
			Yellow	ZB4BP5	0.031/0.068
			Blue	ZB4BP6	0.031/0.068

103542



ZB4BP2S

Silicone booted heads only, standard for mouting with legend holder (IP66)					
	Flush	Colored boot (5)	White	ZB4BP1S	0.034/0.075
			Black	ZB4BP2S	0.034/0.075
			Green	ZB4BP3S	0.034/0.075
			Red	ZB4BP4S	0.034/0.075
			Yellow	ZB4BP5S	0.034/0.075
			Blue	ZB4BP6S	0.034/0.075

PG113450



ZB4BP183

		Clear membrane (5) (2) For insertion of protected legend within head (4)	White	ZB4BP183	0.026/0.057
			Green	ZB4BP383	0.026/0.057
			Red	ZB4BP483	0.026/0.057
			Yellow	ZB4BP583	0.026/0.057
			Blue	ZB4BP683	0.026/0.057

Heads with black metal bezel

To order, add a 7 to the references selected from above.

Example: **ZB4BP18** becomes **ZB4BP187**.

(1) For recommended maximum number of contacts constituting the body (fixing collar and contact) associated with the head, see page 24.

(2) To add customized markings on these references using the web customization tool, see page 5.

(3) Permissible panel thickness 1 to 5 mm/0.039 to 0.197 in., cannot be used with legend holders.

(4) To order a legend for insertion within the head, see page 98.

(5) For replacement of silicone protection element without dismantling head, see page 90.









Assembly of other products using:
 Body/contact assemblies: see page 76
 Accessories: see page 88

Control and signaling units

Harmony XB4, metal

Spring return pushbuttons, with marking

Pushbuttons with flush or projecting push (1) Screw clamp terminal connections (Schneider Electric anti-loosening system)

Shape of head	Type of push	Type of contact		Marking Text (color)	Color of push	Reference	Weight kg/lb
		N/O	N/C				
Complete units							
	Flush	1	–	"I" (White)	Green	XB4BA3311 (ZB4BZ101 + ZB4BA331)	0.080/0.176
	Flush	–	1	"O" (White)	Red	XB4BA4322 (ZB4BZ102 + ZB4BA432)	0.080/0.176
	Projecting	1	1	"O" (White)	Red	XB4BL4325 (ZB4BZ105 + ZB4BL432)	0.080/0.176
	Flush (2)	1	–	↑ (Black)	White	XB4BA3341 (ZB4BZ101 + ZB4BA334)	0.080/0.176
	Flush (2)	1	–	↓ (White)	Black	XB4BA3351 (ZB4BZ101 + ZB4BA335)	0.080/0.176
Heads only							
	Flush			"I" (White)	Green	ZB4BA331	0.029/0.064
				"I" (Black)	White	ZB4BA131	0.029/0.064
				"II" (White)	Green	ZB4BA336	0.029/0.064
				"II" (Black)	White	ZB4BA136	0.029/0.064
				"START" (white)	Green	ZB4BA333	0.029/0.064
				"START" (Black)	White	ZB4BA133	0.029/0.064
				"ON" (White)	Green	ZB4BA341	0.029/0.064
				"ON" (Black)	White	ZB4BA141	0.029/0.064
				"MARCHE" (White)	Green	ZB4BA342	0.029/0.064
				"MARCHE" (Black)	White	ZB4BA142	0.029/0.064
				 (White)	Black	ZB4BA245	0.029/0.064
				 (Black)	White	ZB4BA145	0.029/0.064
				"O" (White)	Red	ZB4BA432	0.029/0.064
					Black	ZB4BA232	0.029/0.064
				"ARRET" (White)	Red	ZB4BA433	0.029/0.064
					Black	ZB4BA233	0.029/0.064
				"STOP" (White)	Red	ZB4BA434	0.029/0.064
					Black	ZB4BA234	0.029/0.064
				"OFF" (White)	Red	ZB4BA435	0.029/0.064
					Black	ZB4BA235	0.029/0.064
		↑ (Black) (2)	White	ZB4BA334	0.029/0.064		
		↓ (White) (2)	Black	ZB4BA335	0.029/0.064		
	Projecting			"O" (White)	Red	ZB4BL432	0.030/0.066
					Black	ZB4BL232	0.030/0.066
				"ARRET" (White)	Red	ZB4BL433	0.030/0.066
					Black	ZB4BL233	0.030/0.066
				"STOP" (White)	Red	ZB4BL434	0.030/0.066
					Black	ZB4BL234	0.030/0.066
				"OFF" (White)	Red	ZB4BL435	0.030/0.066
					Black	ZB4BL235	0.030/0.066

101180

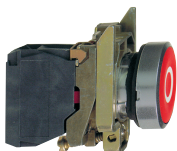

XB4BA4322

101195



ZB4BA331

101196



ZB4BA334

101218



ZB4BL432



Heads with black metal bezel

To order, add a 7 to the references selected from above.
 Example: **ZB4BA331** becomes **ZB4BA3317**.

(1) For recommended maximum number of contacts constituting the body (fixing collar and contact) associated with the head, see page 24.

(2) Product supplied with cap not attached, allowing orientation through 360° in 90° steps.

Assembly of other products using:
 Body/contact assemblies: see page 76
 Combined sub-assemblies: see page 82
 Accessories: see page 88

Illuminated pushbuttons with flush push ⁽¹⁾ ⁽²⁾							
Screw clamp terminal connections (Schneider Electric anti-loosening system)							
Shape of head	Description	Type of contact		Supply voltage V	Color of push	Reference	Weight kg/lb
							

Complete units - With plain lens

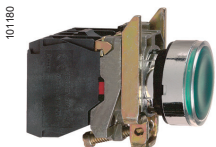

XB4BW33B5

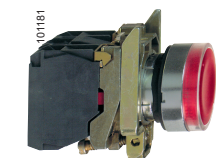

XB4BW34G5

	Integral LED	1	1	24 ~ 50/60 Hz	White	XB4BW31B5 (ZB4BW0B15 + ZB4BW313)	0.097/0.214
					Green	XB4BW33B5 (ZB4BW0B35 + ZB4BW333)	0.097/0.214
					Red	XB4BW34B5 (ZB4BW0B45 + ZB4BW343)	0.097/0.214
					Orange	XB4BW35B5 (ZB4BW0B55 + ZB4BW353)	0.097/0.214
					Blue	XB4BW36B5 (ZB4BW0B65 + ZB4BW363)	0.097/0.214
					110...120 ~ 50/60 Hz	White	XB4BW31G5 (ZB4BW0G15 + ZB4BW313)
	Green	XB4BW33G5 (ZB4BW0G35 + ZB4BW333)	0.097/0.214				
	Red	XB4BW34G5 (ZB4BW0G45 + ZB4BW343)	0.097/0.214				
	Orange	XB4BW35G5 (ZB4BW0G55 + ZB4BW353)	0.097/0.214				
	Blue	XB4BW36G5 (ZB4BW0G65 + ZB4BW363)	0.097/0.214				
	230...240 ~ 50/60 Hz	White	XB4BW31M5 (ZB4BW0M15 + ZB4BW313)	0.097/0.214			
		Green	XB4BW33M5 (ZB4BW0M35 + ZB4BW333)	0.097/0.214			
Red		XB4BW34M5 (ZB4BW0M45 + ZB4BW343)	0.097/0.214				
Orange		XB4BW35M5 (ZB4BW0M55 + ZB4BW353)	0.097/0.214				
Blue		XB4BW36M5 (ZB4BW0M65 + ZB4BW363)	0.097/0.214				

(1) For recommended maximum number of contacts constituting the body (fixing collar and contact) associated with the head, see page 24.

(2) To add customized markings on these references using the web customization tool, see page 5.

Assembly of other products using:
 Combined sub-assemblies: see page 82
 Accessories: see page 88

Control and signaling units

Harmony XB4, metal

Illuminated pushbuttons, spring return, with integral LED

Illuminated pushbuttons with flush push (1)

Shape of head	Type of push	Color	Reference	Weight kg/lb
Heads only (2) - With plain lens				
 101244 ZB4BW333		Flush (3)	White	ZB4BW313 0.026/0.057
			Green	ZB4BW333 0.026/0.057
			Red	ZB4BW343 0.026/0.057
			Orange	ZB4BW353 0.026/0.057
			Yellow	ZB4BW383 0.026/0.057
			Blue	ZB4BW363 0.026/0.057
 XB4_632_CP5CT16035A ZB4BW983		Flush with illuminated ring	White	ZB4BW913 0.026/0.057
			Green	ZB4BW933 0.026/0.057
			Red	ZB4BW943 0.026/0.057
			Orange	ZB4BW953 0.026/0.057
			Yellow	ZB4BW983 0.026/0.057
			Blue	ZB4BW963 0.026/0.057
 PG116073 ZB4BW563		Flush with clear boot (IP69K) (3)	White	ZB4BW513 0.031/0.068
			Green	ZB4BW533 0.031/0.068
			Red	ZB4BW543 0.031/0.068
			Orange	ZB4BW553 0.031/0.068
			Yellow	ZB4BW583 0.031/0.068
			Blue	ZB4BW563 0.031/0.068
 XB4_632_CP5CT17114B ZB4BA98		Flush for insertion of legend (4) (IP69K)	White	ZB4BA18 0.028/0.062
			Green	ZB4BA38 0.028/0.062
			Red	ZB4BA48 0.028/0.062
			Orange	ZB4BA58 0.028/0.062
			Yellow	ZB4BA88 (3) 0.028/0.062
			Blue	ZB4BA68 0.028/0.062
	Illuminated flush pushbutton head, with set of 6 colored caps	White, green, red, orange, yellow, and blue	ZB4BA98 0.022/0.049	
Heads only (2) - With grooved lens (5) (3)				
		Flush	White	ZB4BW313S 0.026/0.057
			Green	ZB4BW333S 0.026/0.057
			Red	ZB4BW343S 0.026/0.057
			Orange	ZB4BW353S 0.026/0.057
			Yellow	ZB4BW383S 0.026/0.057
			Blue	ZB4BW363S 0.026/0.057

(1) For recommended maximum number of contacts constituting the body (fixing collar and contact) associated with the head, see page 24.

(2) For use with bodies comprising a light source with integral LED only.

(3) To add customized markings on these references using the web customization tool, see page 5.

(4) For legend ordering information, see page 98.

(5) For use in bright ambient light conditions (for example, outdoors in sunlight).

Assembly of other products using:
 Combined sub-assemblies: see page 82
 Accessories: see page 88

Control and signaling units

Harmony XB4, metal

Illuminated pushbuttons, spring return, with integral LED



Illuminated pushbuttons with projecting push ⁽¹⁾				
Shape of head	Type of push	Color	Reference	Weight kg/lb
Heads only (2) - With plain lens (3)				
	Projecting	White	ZB4BW113	0.029/0.064
		Green	ZB4BW133	0.029/0.064
		Red	ZB4BW143	0.029/0.064
		Orange	ZB4BW153	0.029/0.064
		Yellow	ZB4BW183	0.029/0.064
		Blue	ZB4BW163	0.029/0.064

Heads only (2) - With grooved lens (4)				
	Projecting	White	ZB4BW113S (3)	0.026/0.057
		Green	ZB4BW133S (3)	0.026/0.057
		Red	ZB4BW143S (3)	0.026/0.057
		Orange	ZB4BW153S	0.026/0.057
		Yellow	ZB4BW183S (3)	0.026/0.057
		Blue	ZB4BW163S (3)	0.026/0.057

Heads with black metal bezel

To order, add a 7 to the references selected from above.

Example 1: **ZB4BW113** becomes **ZB4BW1137**.

Example 2: **ZB4BW113S** becomes **ZB4BW113S7**.

(1) For recommended maximum number of contacts constituting the body (fixing collar and contact) associated with the head, see page 24.

(2) For use with bodies comprising a light source with integral LED only.

(3) To add customized markings on these references using the web customization tool, see page 5.

(4) For use in bright ambient light conditions (for example, outdoors in sunlight).

Assembly of other products using:
 Combined sub-assemblies: see page 82
 Accessories: see page 88

Control and signaling units

Harmony XB4, metal
 Illuminated pushbuttons, spring return,
 with BA 9s base fitting

Illuminated pushbuttons with flush push (1) Screw clamp terminal connections (Schneider Electric anti-loosening system)

Shape of head	Description	Type of contact		Supply voltage V	Color of push	Reference	Weight kg/lb
		NO	NC				

Complete units - With plain lens

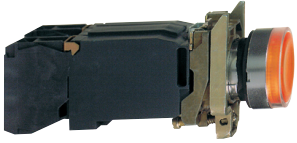
 XB4BW3545	Direct supply for bulb with BA 9s base fitting, 2.4 W max (bulb not included)	1	1	≤ 250	White	XB4BW3165 (ZB4BW065 + ZB4BW31)	0.097/0.214	
					Green	XB4BW3365 (ZB4BW065 + ZB4BW33)	0.097/0.214	
					Red	XB4BW3465 (ZB4BW065 + ZB4BW34)	0.097/0.214	
					Orange	XB4BW3565 (ZB4BW065 + ZB4BW35)	0.097/0.214	
	Via integral transformer 1.2 VA, 6 V secondary, incandescent bulb with BA 9s base fitting (bulb included)	1	1	110...120 ~ 50/60 Hz	White	XB4BW3135 (ZB4BW035 + ZB4BW31)	0.169/0.373	
					Green	XB4BW3335 (ZB4BW035 + ZB4BW33)	0.169/0.373	
					Red	XB4BW3435 (ZB4BW035 + ZB4BW34)	0.169/0.373	
					Orange	XB4BW3535 (ZB4BW035 + ZB4BW35)	0.169/0.373	
		230 ~ 50 Hz 220...240 ~ 60 Hz	1	1	230 ~ 50 Hz 220...240 ~ 60 Hz	White	XB4BW3145 (ZB4BW045 + ZB4BW31)	0.170/0.375
						Green	XB4BW3345 (ZB4BW045 + ZB4BW33)	0.170/0.375
						Red	XB4BW3445 (ZB4BW045 + ZB4BW34)	0.170/0.375
						Orange	XB4BW3545 (ZB4BW045 + ZB4BW35)	0.170/0.375

Heads only (2) - With plain lens

 ZB4BW33	Flush	White	ZB4BW31	0.027/0.060
		Green	ZB4BW33	0.027/0.060
		Red	ZB4BW34	0.027/0.060
		Orange	ZB4BW35	0.027/0.060
		Blue	ZB4BW36	0.027/0.060
		Clear	ZB4BW37	0.027/0.060

Heads only (2) - With grooved lens (3)

	Flush	White	ZB4BW31S	0.027/0.060
		Green	ZB4BW33S	0.027/0.060
		Red	ZB4BW34S	0.027/0.060
		Orange	ZB4BW35S	0.027/0.060
		Blue	ZB4BW36S	0.027/0.060
		Clear	ZB4BW37S	0.027/0.060

Illuminated pushbuttons with projecting push (1)

Heads only (2) - With plain lens

 ZB4BW14	Projecting	White	ZB4BW11	0.028/0.062
		Green	ZB4BW13	0.028/0.062
		Red	ZB4BW14	0.028/0.062
		Orange	ZB4BW15	0.028/0.062
		Blue	ZB4BW16	0.028/0.062
		Clear	ZB4BW17	0.028/0.062

Heads only (2) - With grooved lens (3)

	Projecting	White	ZB4BW11S	0.027/0.060
		Green	ZB4BW13S	0.027/0.060
		Red	ZB4BW14S	0.027/0.060
		Orange	ZB4BW15S	0.027/0.060
		Blue	ZB4BW16S	0.027/0.060
		Clear	ZB4BW17S	0.027/0.060

Heads with black metal bezel

To order, add a 7 to the references selected from above.

Example 1: **ZB4BW31** becomes **ZB4BW317**. Example 2: **ZB4BW31S** becomes **ZB4BW31S7**.

(1) For recommended maximum number of contacts constituting the body (fixing collar and contact) associated with the head, see page 24.

(2) For use with bodies comprising a light source with BA9s base fitting bulb (incandescent, neon, or LED) only.

(3) For use in bright ambient light conditions (for example, outdoors in sunlight).

Assembly of other products using:
 Body/contact assemblies: see page 76
 Accessories: see page 88

Control and signaling units

Harmony XB4, metal

Flush mounted spring return pushbuttons, unmarked

Flush mounted pushbuttons with flush push for Ø 30 mm ⁽¹⁾ ⁽²⁾							
Screw clamp terminal connections (Schneider Electric anti-loosening system)							
Shape of head	Type of push	Type of contact		Marking on bezel Text (color)	Color of push	Reference	Weight kg/lb
		NO	NC				

Complete units							
	Flush	1	-		White	XB4FA11 (ZB4BZ101 + ZB4FA1)	0.080/0.176
					Black	XB4FA21 (ZB4BZ101 + ZB4FA2)	0.080/0.176
					Green	XB4FA31 (ZB4BZ101 + ZB4FA3)	0.080/0.176
					Yellow	XB4FA51 (ZB4BZ101 + ZB4FA5)	0.080/0.176
					Blue	XB4FA61 (ZB4BZ101 + ZB4FA6)	0.080/0.176
					Red	XB4FA42 (ZB4BZ102 + ZB4FA4)	0.080/0.176

Heads only							
	Without cap ⁽³⁾				-	ZB4FA0	0.028/0.062
	Flush, with set of 6 colored caps				6 colors ⁽⁴⁾	ZB4FA9	0.038/0.084
	Flush				White	ZB4FA1	0.029/0.064
					Black	ZB4FA2	0.029/0.064
					Green	ZB4FA3	0.029/0.064
					Red	ZB4FA4	0.029/0.064
					Yellow	ZB4FA5	0.029/0.064
					Blue	ZB4FA6	0.029/0.064
					Gray	ZB4FA8	0.029/0.064
					White	ZB4FA18	0.028/0.062
					Green	ZB4FA38	0.028/0.062
					Red	ZB4FA48	0.028/0.062
	Flush with transparent cap for insertion of legend ⁽⁵⁾				Yellow	ZB4FA58	0.028/0.062
					Blue	ZB4FA68	0.028/0.062

Heads only with marked bezel							
	Flush			"START" (Black)	Green	ZB4FA3M33	0.029/0.064

Pushbuttons with recessed push ⁽¹⁾								
High guard								
Shape of head	Type of push				Color	Reference	Weight kg/lb	
	Recessed (high guard)					White	ZB4FA16 ⁽²⁾	0.034/0.075
						Black	ZB4FA26 ⁽²⁾	0.034/0.075
						Green	ZB4FA36 ⁽²⁾	0.034/0.075
						Red	ZB4FA46 ⁽²⁾	0.034/0.075
						Yellow	ZB4FA56	0.034/0.075
						Blue	ZB4FA66	0.034/0.075

(1) For recommended maximum number of contacts constituting the body (fixing collar and contact) associated with the head, see page 24.

(2) To add customized markings on these references using the web customization tool, see page 5.

(3) Colored cap to be ordered separately: see page 88.

(4) Head supplied with 6 different colored caps (white, black, green, red, yellow, and blue) not fitted.

(5) For legend ordering information, see page 98.

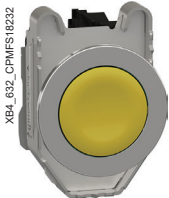

XB4FA51

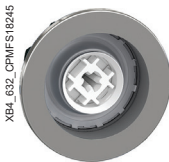

ZB4FA0

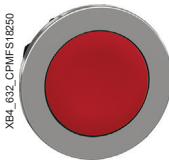

ZB4FA4



ZB4FA38



ZB4FA3M33

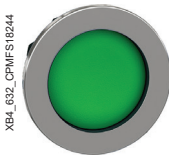

ZB4FA36

Assembly of other products using:
 Body/contact assemblies: see page 76
 Accessories: see page 88

Control and signaling units

Harmony XB4, metal

Flush mounted spring return pushbuttons, unmarked



XB4FL42



ZB4FL1



ZB4FL4M34

Flush mounted pushbuttons with projecting push for Ø 30 mm ^{(1) (2)}

Screw clamp terminal connections (Schneider Electric anti-loosening system)							
Shape of head	Type of push	Type of contact		Marking on bezel Text (color)	Color of push	Reference	Weight kg/lb
		NO	NC				

Complete units

	Projecting	–	1	–	Red	XB4FL42 (ZB4BZ102 + ZB4FL4)	0.081/0.179
--	------------	---	---	---	-----	---------------------------------------	-------------

Heads only

	Projecting				White	ZB4FL1	0.030/0.066
					Black	ZB4FL2	0.030/0.066
					Green	ZB4FL3	0.030/0.066
					Red	ZB4FL4	0.030/0.066
					Yellow	ZB4FL5	0.030/0.066
					Blue	ZB4FL6	0.030/0.066

Heads only with marked bezel

	Projecting			"STOP" (Black)	Red	ZB4FL4M34	0.030/0.066
--	------------	--	--	----------------	-----	------------------	-------------

(1) For recommended maximum number of contacts constituting the body (fixing collar and contact) associated with the head, see page 24.
 (2) To add customized markings on these references using the web customization tool, see page 5.

Assembly of other products using:
 Body/contact assemblies: see page 76
 Accessories: see page 88

Control and signaling units

Harmony XB4, metal

Flush mounted spring return pushbuttons, with marking



XB4FA4322

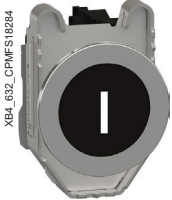

ZB4FA331

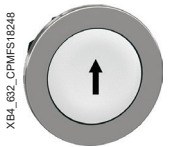

ZB4FA334



ZB4FL432

Flush mounted pushbuttons with flush or projecting push for Ø 30 mm ⁽¹⁾							
Screw clamp terminal connections (Schneider Electric anti-loosening system)							
Shape of head	Type of push	Type of contact		Marking Text (color)	Color of push	Reference	Weight kg/lb
		N/O	N/C				
Complete units ⁽²⁾							
	Flush	1	–	"I" (White)	Green	XB4FA3311 (ZB4BZ101 + ZB4FA331)	0.080/0.176
	Flush	–	1	"O" (White)	Red	XB4FA4322 (ZB4BZ102 + ZB4FA432)	0.080/0.176
	Projecting	1	1	"O" (White)	Red	XB4FL4325 (ZB4BZ105 + ZB4FL432)	0.080/0.176
	Flush (3)	1	–	↑ (Black)	White	XB4FA3341 (ZB4BZ101 + ZB4FA334)	0.080/0.176
	Flush (3)	1	–	↓ (White)	Black	XB4FA3351 (ZB4BZ101 + ZB4FA335)	0.080/0.176
Heads only							
	Flush			"I" (White)	Green	ZB4FA331 (2)	0.029/0.064
				"I" (Black)	White	ZB4FA131 (2)	0.029/0.064
				"II" (White)	Green	ZB4FA336	0.029/0.064
				"II" (Black)	White	ZB4FA136	0.029/0.064
				"START" (white)	Green	ZB4FA333 (2)	0.029/0.064
				"START" (Black)	White	ZB4FA133	0.029/0.064
				"ON" (White)	Green	ZB4FA341	0.029/0.064
				"ON" (Black)	White	ZB4FA141	0.029/0.064
				"MARCHE" (White)	Green	ZB4FA342	0.029/0.064
				"MARCHE" (Black)	White	ZB4FA142	0.029/0.064
					Black	ZB4FA245	0.029/0.064
					White	ZB4FA145	0.029/0.064
				"O" (White)	Red	ZB4FA432 (2)	0.029/0.064
					Black	ZB4FA232 (2)	0.029/0.064
				"ARRET" (White)	Red	ZB4FA433	0.029/0.064
					Black	ZB4FA233	0.029/0.064
				"STOP" (White)	Red	ZB4FA434 (2)	0.029/0.064
					Black	ZB4FA234	0.029/0.064
				"OFF" (White)	Red	ZB4FA435	0.029/0.064
					Black	ZB4FA235	0.029/0.064
			↑ (Black) (3)	White	ZB4FA334 (2)	0.029/0.064	
			↓ (White) (3)	Black	ZB4FA335 (2)	0.029/0.064	
	Projecting			"O" (White)	Red	ZB4FL432 (2)	0.030/0.066
					Black	ZB4FL232 (2)	0.030/0.066
				"ARRET" (White)	Red	ZB4FL433	0.030/0.066
					Black	ZB4FL233	0.030/0.066
				"STOP" (White)	Red	ZB4FL434 (2)	0.030/0.066
					Black	ZB4FL234	0.030/0.066
				"OFF" (White)	Red	ZB4FL435	0.030/0.066
					Black	ZB4FL235	0.030/0.066

(1) For recommended maximum number of contacts constituting the body (fixing collar and contact) associated with the head, see page 24.

(2) To add customized markings on these references using the web customization tool, see page 5.

(3) Product supplied with cap not attached, allowing orientation through 360° in 90° steps.

References

Assembly of other products using:
 Body/contact assemblies: see page 76
 Combined sub-assemblies: see page 82
 Accessories: see page 88



Control and signaling units

Harmony XB4, metal

Flush mounted illuminated pushbuttons, spring return,
 with integral LED

Flush mounted illuminated pushbuttons with flush push for Ø 30 mm ⁽¹⁾ ⁽²⁾

Screw clamp terminal connections (Schneider Electric anti-loosening system)

Shape of head	Description	Type of contact		Supply voltage V	Color of push	Reference	Weight kg/lb	
								
Complete units - With plain lens								
 Protected LED	Integral LED	1	1	24 ~ 50/60 Hz	White	XB4FW31B5 (ZB4BW0B15 + ZB4FW313)	0.097/0.214	
					Green	XB4FW33B5 (ZB4BW0B35 + ZB4FW333)	0.097/0.214	
					Red	XB4FW34B5 (ZB4BW0B45 + ZB4FW343)	0.097/0.214	
					Orange	XB4FW35B5 (ZB4BW0B55 + ZB4FW353)	0.097/0.214	
					Blue	XB4FW36B5 (ZB4BW0B65 + ZB4FW363)	0.097/0.214	
	110...120 ~ 50/60 Hz					White	XB4FW31G5 (ZB4BW0G15 + ZB4FW313)	0.097/0.214
						Green	XB4FW33G5 (ZB4BW0G35 + ZB4FW333)	0.097/0.214
						Red	XB4FW34G5 (ZB4BW0G45 + ZB4FW343)	0.097/0.214
						Orange	XB4FW35G5 (ZB4BW0G55 + ZB4FW353)	0.097/0.214
						Blue	XB4FW36G5 (ZB4BW0G65 + ZB4FW363)	0.097/0.214
						230...240 ~ 50/60 Hz		
	Green	XB4FW33M5 (ZB4BW0M35 + ZB4FW333)	0.097/0.214					
	Red	XB4FW34M5 (ZB4BW0M45 + ZB4FW343)	0.097/0.214					
	Orange	XB4FW35M5 (ZB4BW0M55 + ZB4FW353)	0.097/0.214					
	Blue	XB4FW36M5 (ZB4BW0M65 + ZB4FW363)	0.097/0.214					

(1) For recommended maximum number of contacts constituting the body (fixing collar and contact) associated with the head, see page 24.

(2) To add customized markings on these references using the web customization tool, see page 5.

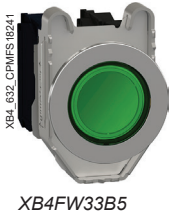



Assembly of other products using:
 Combined sub-assemblies: see page 82
 Accessories: see page 88

Control and signaling units

Harmony XB4, metal

Flush mounted illuminated pushbuttons, spring return,
 with integral LED

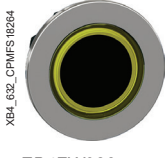
Flush mounted illuminated pushbuttons with flush push for Ø 30 mm ⁽¹⁾

Shape of head	Type of push	Color	Reference	Weight kg/lb	
Heads only ⁽²⁾ - With plain lens					
 ZB4FW333  ZB4FW983		Flush ⁽³⁾	White	ZB4FW313	0.026/0.057
			Green	ZB4FW333	0.026/0.057
			Red	ZB4FW343	0.026/0.057
			Orange	ZB4FW353	0.026/0.057
			Blue	ZB4FW363	0.026/0.057
			Yellow	ZB4FW383	0.026/0.057
		Flush with illuminated ring	White	ZB4FW913	0.026/0.057
			Green	ZB4FW933	0.026/0.057
			Red	ZB4FW943	0.026/0.057
			Orange	ZB4FW953	0.026/0.057
			Blue	ZB4FW963	0.026/0.057
			Yellow	ZB4FW983	0.026/0.057
		Flush for insertion of legend ⁽⁴⁾ ⁽³⁾ (IP69K)	White	ZB4FA18	0.028/0.062
			Green	ZB4FA38	0.028/0.062
			Red	ZB4FA48	0.028/0.062
	Orange	ZB4FA58	0.028/0.062		
	Blue	ZB4FA68	0.028/0.062		
	Yellow	ZB4FA88	0.028/0.062		

(1) For recommended maximum number of contacts constituting the body (fixing collar and contact) associated with the head, see page 24.

(2) For use with bodies comprising a light source with integral LED only.

(3) To add customized markings on these references using the web customization tool, see page 5.

(4) For legend ordering information, see page 98.

Assembly of other products using:
 Combined sub-assemblies: see page 82
 Accessories: see page 88

Control and signaling units

Harmony XB4, metal

Flush mounted illuminated pushbuttons, spring return, with integral LED

XB4_632_CPMFS18263



ZB4FW113



Flush mounted illuminated pushbuttons with projecting push for Ø 30 mm ^{(1) (2)}				
Shape of head	Type of push	Color	Reference	Weight kg/lb
Heads only (3) - With plain lens				
	Projecting	White	ZB4FW113	0.029/0.064
		Green	ZB4FW133	0.029/0.064
		Red	ZB4FW143	0.029/0.064
		Orange	ZB4FW153	0.029/0.064
		Blue	ZB4FW163	0.029/0.064
		Yellow	ZB4FW183	0.029/0.064

- (1) For recommended maximum number of contacts constituting the body (fixing collar and contact) associated with the head, see page 24.
 (2) To add customized markings on these references using the web customization tool, see page 5.
 (3) For use with bodies comprising a light source with integral LED only.

User assembly of other units, using:
 Body-contact assemblies: see page 76
 Combined sub-assemblies: see page 82

Control and signaling units

Harmony XB4 metal

Multiple-headed pushbuttons, spring return



XB4BL73415



ZB4BA7121



ZB4BL7341



XB4BW73731●5



ZB4BW7A1721



ZB4BW7A3741

Double-headed pushbuttons ⁽¹⁾

Screw clamp terminal connections (Schneider Electric anti-loosening system)

Shape of head	Description	Type of contact		Color and marking of caps ⁽²⁾	Reference	Weight kg/lb
		NO	NC			

Complete units

	2 pushes (1 flush Black + 1 projecting Red)	1	1	White "I" on Green background White "0" on Red background	XB4BL73415	0.116/0.256
--	---	---	---	--	-------------------	-------------

Heads only

	2 flush Black pushes			White and Black background, unmarked	ZB4BA7120	0.056/0.123
				Black "I" on White background White "0" on Black background	ZB4BA7121	0.056/0.123
				Green and Red background, unmarked	ZB4BA7340	0.056/0.123
				White "I" on Green background White "0" on Red background	ZB4BA7341	0.056/0.123
				Without cap ⁽³⁾	ZB4BA79	0.056/0.123

	1 flush Black push 1 projecting Red push			Green and Red background, unmarked	ZB4BL7340	0.056/0.123
				White "I" on Green background White "0" on Red background	ZB4BL7341	0.056/0.123

Double-headed pushbuttons + 1 white central pilot light block ⁽¹⁾

Screw clamp terminal connections (Schneider Electric anti-loosening system)

Shape of head	Description	Type of contact		Color and marking of caps ⁽²⁾	Pilot light voltage V	Reference	Weight kg/lb
		NO	NC				

Complete units

	1 flush Black push 1 projecting Red push 1 White central pilot light block	1	1	White "I" on Green background White "0" on Red background	24	XB4BW73731B5	0.130/0.287
					120	XB4BW73731G5	0.130/0.287
					240	XB4BW73731M5	0.130/0.287

Heads only ⁽⁵⁾

	2 flush Black pushes 1 clear central pilot light ⁽⁴⁾			White and Black background, unmarked		ZB4BW7A1720	0.056/0.123
				Black "I" on White background White "0" on Black background		ZB4BW7A1721	0.056/0.123
				Green and Red background, unmarked		ZB4BW7A3740	0.056/0.123
				White "I" on Green background White "0" on Red background		ZB4BW7A3741	0.056/0.123
				Black "I" on White background White "0" on Black background		ZB4BW7A1724	0.056/0.123
				Black "+" on White background Black "-" on White background		ZB4BW7A1715	0.056/0.123
				Without cap ⁽³⁾		ZB4BW7A9	0.056/0.123

	1 flush Black push 1 projecting Red push 1 clear central pilot light ⁽⁴⁾			Green and Red background, unmarked		ZB4BW7L3740	0.056/0.123
				White "I" on Green background White "0" on Red background		ZB4BW7L3741	0.056/0.123

Heads with black metal bezel

To order, add the suffix 7 to the references selected above. Example: **ZB4BA7120** becomes **ZB4BA71207**.

- (1) Recommended maximum number of contacts constituting the body (fixing collar and contact) associated with the head, see page 24.
- (2) These caps are fitted by Schneider Electric and cannot be removed (risk of damage).
- (3) Caps to be ordered separately; see page opposite.
- (4) Color of centrally positioned pilot light determined by the color of the LED incorporated in the body sub-assembly.
- (5) Only for use with bodies comprising a light source with integral LED.

User assembly of other units, using:
 Body-contact assemblies: see page 76
 Combined sub-assemblies: see page 82

Control and signaling units

Harmony XB4 metal

Multiple-headed pushbuttons, spring return

Triple-headed pushbuttons (1) (2)							
Screw clamp terminal connections (Schneider Electric anti-loosening system)							
Shape of head	Description	Type of contact			Color and marking of caps (3)	Reference	Weight kg/lb
		NO	NC	NO			

Complete units							
	2 flush Black pushes + 1 central projecting Red push marked "Stop" in White	1	1	1	White "I" on Green background White "II" on Green background	XB4BA731327	0.128/0.282
					Black "→" on White background White "←" on Black background	XB4BA711237	0.128/0.282

Heads only							
	2 flush Black pushes + 1 central projecting Red push marked "Stop" in White				White "I" on Green background White "II" on Green background	ZB4BA73132	0.056/0.123
					White "←" on Green background White "→" on Green background	ZB4BA73133	0.056/0.123
					White "↑" on Green background White "↓" on Green background	ZB4BA73134	0.056/0.123
					White "+" on Green background White "-" on Green background	ZB4BA73135	0.056/0.123
					Black "+" on White background Black "-" on White background	ZB4BA71115	0.056/0.123
					Black "→" on White background White "←" on black background	ZB4BA71123	0.056/0.123
					Black "↑" on White background White "↓" on Black background	ZB4BA71124	0.056/0.123
					White "↑" on Black background White "↓" on Black background	ZB4BA72124	0.056/0.123
					Without cap (4)	ZB4BA791	0.056/0.123

Specific accessories for multiple-headed pushbuttons

Description	Background color	Marking	Sold in lots of	Reference	Weight kg/lb	
Caps only for clip-on mounting (5) on: - ZB4BA79 double-headed pushbuttons - ZB4BW7A9 double-headed pushbuttons + central pilot light block - ZB4BA791 triple-headed pushbuttons	White	Unmarked	10	ZBA71	0.010/0.022	
		"I" Black	10	ZBA7131	0.010/0.022	
		"→" Black	10	ZBA7134	0.010/0.022	
		"+" Black	10	ZBA7138	0.010/0.022	
	Black	Unmarked	10	ZBA72	0.010/0.022	
		"O" White	10	ZBA7232	0.010/0.022	
		"+" White	10	ZBA7233	0.010/0.022	
		"→" White	10	ZBA7235	0.010/0.022	
			"I" White	10	ZBA7237	0.010/0.022
	Green	Unmarked	10	ZBA73	0.010/0.022	
		"I" White	10	ZBA7331	0.010/0.022	
		"+" White	10	ZBA7333	0.010/0.022	
"↑" White		10	ZBA7335	0.010/0.022		
		"II" White	10	ZBA7336	0.010/0.022	
Red	Unmarked	10	ZBA74	0.010/0.022		
	"O" White	10	ZBA7432	0.010/0.022		
Yellow	Unmarked	10	ZBA75	0.010/0.022		
Blue	Unmarked	10	ZBA76	0.010/0.022		

Clear silicone boots (6)					
For 2 flush pushes	-	10	ZBA708	0.055/0.121	
For 3 pushes	-	10	ZBA709	0.055/0.121	
For 1 flush push + 1 projecting push	-	10	ZBA710	0.055/0.121	

Heads with black metal bezel

To order, add the suffix 7 to the references selected above.

Example: **ZB4BA73132** becomes **ZB4BA731327**.

(1) Recommended maximum number of contacts constituting the body (fixing collar and contact) associated with the head, see page 24.

(2) Not compatible with high power switching contacts and contacts for printed circuit board.

(3) These caps are fitted by Schneider Electric and cannot be removed (risk of damage).

(4) Caps to be ordered separately: see accessories on this page.

(5) Can be clipped-in at 90° steps, through 360°.

(6) Can be replaced without dismantling the head.



XB4BA731327



ZB4BA73133



ZB4BA71124



ZBA7235



ZBA7432



ZBA709

Assembly of other products using:
 Body/contact assemblies: see page 76
 Accessories: see page 88

Mushroom head pushbuttons ^{(1) (2)}						
Screw clamp terminal connections (Schneider Electric anti-loosening system)						
Shape of head	Type of push	Type of contact		Push Ø (mm)/in.	Color	Reference
		NO	NC			

Complete units							
	Mushroom head	1	–	40/1.575	Black	XB4BC21 (ZB4BZ101 + ZB4BC2)	0.122/0.269

Heads only							
	Mushroom head			30/1.181	Black	ZB4BC24	0.075/0.165
					Green	ZB4BC34	0.075/0.165
					Red	ZB4BC44	0.075/0.165
					Yellow	ZB4BC54	0.075/0.165
					Blue	ZB4BC64	0.075/0.165
				40/1.575	Black	ZB4BC2	0.074/0.163
					Green	ZB4BC3	0.074/0.163
					Red	ZB4BC4	0.074/0.163
					Yellow	ZB4BC5	0.074/0.163
					Blue	ZB4BC6	0.074/0.163
				60/2.362	Black	ZB4BR2	0.093/0.205
					Green	ZB4BR3	0.093/0.205
					Red	ZB4BR4	0.093/0.205
					Yellow	ZB4BR5	0.093/0.205
					Blue	ZB4BR6	0.093/0.205
				60/2.362 (3)	Black	ZB4BR216	0.054/0.119
					Green	ZB4BR316	0.054/0.119
					Red	ZB4BR416	0.054/0.119
					Yellow	ZB4BR516	0.054/0.119
					Blue	ZB4BR616	0.054/0.119

Illuminated mushroom head pushbuttons ^{(1) (2)}

Integral LED						
Shape of head	Type of push	Push Ø (mm)/in.	Color	Reference	Weight kg/lb	
Heads only ⁽⁴⁾						
	Mushroom head	40/1.575	White	ZB4BW413	0.051/0.112	
			Green	ZB4BW433	0.051/0.112	
			Red	ZB4BW443	0.051/0.112	
			Orange	ZB4BW453	0.051/0.112	
			Blue	ZB4BW463	0.051/0.112	

Heads with black metal bezel



To order, add a figure 7 to the references selected above.
 Example: **ZB4BC24** becomes **ZB4BC247**.

- (1) These pushbuttons and heads cannot be used for an Emergency Stop function. Therefore, it is recommended that a legend with a Black or White background is used.
- (2) Recommended maximum number of contacts constituting the body (fixing collar and contact) associated with the head, see page 24.
- (3) Ergonomic product used in two-handed control applications. Recommended maximum number of contacts constituting the body (fixing collar and contact) associated with the head: 6.
- (4) Only for use with bodies comprising a light block with integral LED.

Assembly of other products using:
 Body/contact assemblies: see page 76
 Accessories: see page 88

Control and signaling units

Harmony XB4, metal
 Mushroom head pushbuttons, latching
 Bellows for harsh environment

Mushroom head pushbuttons (1)(2)						
Shape of head	Type of reset	Push	Color	Reference	Weight	
		Ø (mm)/in.			kg/lb	
Heads only						
	Push-pull	40/1.575	Black	ZB4BT2	0.077/0.170	
		60/2.362	Black	ZB4BX2	0.095/0.209	
	Turn to release	30/1.181	Black	ZB4BS42	0.066/0.146	
		40/1.575	Black	ZB4BS52	0.070/0.154	
		40/1.575	Yellow	ZB4BS55	0.070/0.154	
		60/2.362	Black	ZB4BS62	0.090/0.198	
	Key release (key no. 455) (2 keys included with head) (3) (4)	30/1.181	Black	ZB4BS72	0.066/0.146	
		40/1.575	Black	ZB4BS12 (5)	0.070/0.154	
		60/2.362	Black	ZB4BS22	0.090/0.198	

110130



ZB4BT2

PG113908



ZB4BS62

110136



ZB4BS72

Illuminated mushroom head pushbuttons (1) (2)						
Integral LED						
Shape of head	Type of reset	Push	Color	Reference	Weight	
		Ø (mm)/in.			kg/lb	
Heads only						
	Mushroom head	40/1.575	White	ZB4BW613	0.051/0.112	
			Green	ZB4BW633	0.051/0.112	
			Orange	ZB4BW653	0.051/0.112	
			Blue	ZB4BW663	0.051/0.112	

XB4_632_CP00A2016012



ZB4BW653

107361



ZBZ48

Bellows for harsh environment (IP 69K)						
For use in	Material	Color	Sold in lots of	Reference	Weight	
					kg/lb	
Environment subject to humidity, dust, high pressure cleaning, etc.	Silicone	Red	2	ZBZ48	0.009/0.020	

Heads with black metal bezel

To order, add a figure 7 to the references selected above.
 Example: ZB4BT2 becomes ZB4BT27.

- (1) These pushbuttons and heads cannot be used for an Emergency Stop function. Therefore, it is recommended that a legend with a Black or White background is used.
- (2) Recommended maximum number of contacts constituting the body (fixing collar and contact) associated with the head, see page 24.
- (3) For specific keys with other numbers, please contact our Customer Care Center.
- (4) The symbol  indicates key withdrawal position(s).
- (5) Other key numbers:
 - key no. 421E: add suffix 12 to the reference.
 - key no. 458A: add suffix 10 to the reference.
 - key no. 520E: add suffix 14 to the reference.
 - key no. 3131A: add suffix 20 to the reference.
 Example: To order a Ø 40/1.575 in. Black mushroom head for a latching pushbutton, with release by key no. 421E, the reference becomes: ZB4BS1212.

Assembly of other products using:
Body/contact assemblies: see page 76
Accessories: see page 97 and 104

Emergency stop and Emergency switching off functions conforming to EN/IEC 60204-1, 60364-5-53, EN/ISO 13850 and Machinery Directive 2006/42/EC





Emergency stop function: Mushroom head Emergency stop trigger action and mechanical latching pushbuttons conform to standards EN/IEC 60204-1 and EN/ISO 13850, Machinery Directive 2006/42/EC, and to standard EN/IEC 60947-5-5.

Emergency switching off function: Mushroom head switching off mechanical latching pushbuttons conform to standards IEC 60364-5-53 and EN/IEC 60947-5-5.

Please contact our Customer Care Center for a detailed explanation of these standards and directives.

Emergency stop and switching off pushbuttons with trigger action and mechanical latching ^{(1) (2)}

Screw clamp terminal connections (Schneider Electric anti-loosening system)

Shape of head	Type of reset	Type of contact		Push Ø (mm)/in.	Color	Reference	Weight kg/lb
							
Complete units							
	Push-pull	–	1	40/1.575	Red	XB4BT842 (ZB4BZ105 + ZB4BT84)	0.125/0.276
		1	1	40/1.575	Red	XB4BT845 (ZB4BZ105 + ZB4BT84)	0.136/0.300
	Turn to release	–	1	40/1.575	Red	XB4BS8442 (ZB4BZ102 + ZB4BS844)	0.118/0.260
		1	1	40/1.575	Red	XB4BS8445 (ZB4BZ105 + ZB4BS844)	0.130/0.287
		–	2	40/1.575	Red	XB4BS8444 (ZB4BZ104 + ZB4BS844)	0.130/0.287
		1	2	40/1.575	Red	XB4BS84441 (ZB4BZ141 + ZB4BS844)	0.140/0.309
	Key release (key no. 455) ⁽³⁾	1	1	40/1.575	Red	XB4BS9445 (ZB4BZ105 + ZB4BS944)	0.170/0.375

(1) For recommended maximum number of contacts constituting the body (fixing collar + contact) associated with the head, see page 24.

(2) It is recommended that a legend or yellow background is used.

(3) The symbol  indicates key withdrawal position(s).

PF512504

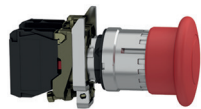

XB4BT845

PF512505

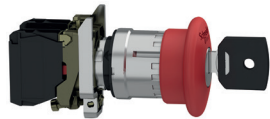

XB4BS9445

Assembly of other products using:
 Body/contact assemblies: see page 76
 Accessories: see page 101 and 104

Emergency stop and Emergency switching off functions conforming to EN/IEC 60204-1, 60364-5-53, EN/ISO 13850 and Machinery Directive 2006/42/EC



Emergency stop function: Mushroom head Emergency stop trigger action and mechanical latching pushbuttons conform to standards EN/IEC 60204-1 and EN/ISO 13850, Machinery Directive 2006/42/EC, and to standard EN/IEC 60947-5-5.

Emergency switching off function: Mushroom head switching off mechanical latching pushbuttons conform to standards IEC 60364-5-53 and EN/IEC 60947-5-5.

Please contact our Customer Care Center for a detailed explanation of these standards and directives.

Emergency stop and switching off pushbuttons with trigger action and mechanical latching (1) (2)
Screw clamp terminal connections (Schneider Electric anti-loosening system)

Heads only

Shape of head	Type of reset	Push		Reference	Weight kg/lb
		Ø (mm)/in.	Color		
	Push-pull	30/1.181	Red	ZB4BT844	0.078/0.172
		40/1.575	Red	ZB4BT84	0.078/0.172
		60/2.362	Red	ZB4BX84	0.098/0.216
	Turn to release	30/1.181	Red	ZB4BS834	0.068/0.150
		40/1.575	Red	ZB4BS844	0.073/0.161
		60/2.362	Red	ZB4BS864	0.093/0.205
	Key release (key no. 455) 2 keys included with head (3) (4)	30/1.181	Red	ZB4BS934	0.094/0.207
		40/1.575	Red	ZB4BS944 (5)	0.098/0.216
		60/2.362	Red	ZB4BS964	0.118/0.260

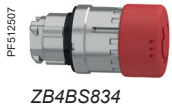
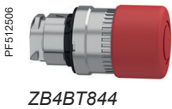

Heads with black metal bezel

To order, add a 7 to the references selected from above.
 Example: **ZB4BT844** becomes **ZB4BT8447**.

(1) For recommended maximum number of contacts constituting the body (fixing collar + contact) associated with the head, see page 24.

(2) It is recommended that a legend or yellow background is used.

(3) The symbol Ω indicates key withdrawal position(s).

(4) For specific keys with other numbers, please contact our Customer Care Center.

(5) Other key numbers:

- Key no. 421E: add suffix **12** to the reference.

- Key no. 458A: add suffix **10** to the reference.

- Key no. 520E: add suffix **14** to the reference.

- Key no. 3131A: add suffix **20** to the reference.

- Key no. 4A185: add suffix **D** to the reference.

Example: To order a Ø 40 mm/1.575 in. red mushroom head for a trigger action and mechanical latching Emergency stop pushbutton, with release by key no. 421E, the reference becomes: **ZB4BS94412**.

Control and signaling units

Harmony XB4, metal
Illuminated rings for Emergency stop
Circular yellow legends for Emergency stop

XB4_632_CPMFS18026A



ZBY9W2B330

PF131618A



ZBY9W3B140

PF131618A



ZBY9121

PF131622A



ZBY9420

Illuminated rings for Emergency stop (1)

Description	Marking	Signaling	Supply voltage	Color	Sold in lots of	Reference	Weight kg/lb
Ø 60 mm/2.362 in. illuminated ring for Emergency stop	EMERGENCY STOP	Fixed, red	24 V ~	Yellow	1	ZBY9W2B330	0.031/0.068
	ARRET D'URGENCE	Fixed, red	24 V ~	Yellow	1	ZBY9W2B130	0.031/0.068
	NOT HALT	Fixed, red	24 V ~	Yellow	1	ZBY9W2B230	0.031/0.068
	PARADA DE EMERGENCIA	Fixed, red	24 V ~	Yellow	1	ZBY9W2B430	0.031/0.068
	ARRESTO DI EMERGENZA	Fixed, red	24 V ~	Yellow	1	ZBY9W2B630	0.031/0.068
	-	Fixed, red	24 V ~	Yellow	1	ZBY9W2B140	0.031/0.068
	EMERGENCY STOP	Fixed, red	120 V ~	Yellow	1	ZBY9W2G330	0.031/0.068
	ARRET D'URGENCE	Fixed, red	120 V ~	Yellow	1	ZBY9W2G130	0.031/0.068
	NOT HALT	Fixed, red	120 V ~	Yellow	1	ZBY9W2G230	0.031/0.068
	PARADA DE EMERGENCIA	Fixed, red	120 V ~	Yellow	1	ZBY9W2G430	0.031/0.068
	ARRESTO DI EMERGENZA	Fixed, red	120 V ~	Yellow	1	ZBY9W2G630	0.031/0.068
	-	Fixed, red	120 V ~	Yellow	1	ZBY9W2G140	0.031/0.068
	EMERGENCY STOP	Fixed, red	230 V ~	Yellow	1	ZBY9W2M330	0.031/0.068
	ARRET D'URGENCE	Fixed, red	230 V ~	Yellow	1	ZBY9W2M130	0.031/0.068
NOT HALT	Fixed, red	230 V ~	Yellow	1	ZBY9W2M230	0.031/0.068	
PARADA DE EMERGENCIA	Fixed, red	230 V ~	Yellow	1	ZBY9W2M430	0.031/0.068	
ARRESTO DI EMERGENZA	Fixed, red	230 V ~	Yellow	1	ZBY9W2M630	0.031/0.068	
-	Fixed, red	230 V ~	Yellow	1	ZBY9W2M140	0.031/0.068	
EMERGENCY STOP	Fixed, red + white	24 V ~	Yellow	1	ZBY9W3B330	0.031/0.068	
ARRET D'URGENCE	Fixed, red + white	24 V ~	Yellow	1	ZBY9W3B130	0.031/0.068	
NOT HALT	Fixed, red + white	24 V ~	Yellow	1	ZBY9W3B230	0.031/0.068	
PARADA DE EMERGENCIA	Fixed, red + white	24 V ~	Yellow	1	ZBY9W3B430	0.031/0.068	
ARRESTO DI EMERGENZA	Fixed, red + white	24 V ~	Yellow	1	ZBY9W3B630	0.031/0.068	
-	Fixed, red + white	24 V ~	Yellow	1	ZBY9W3B140	0.031/0.068	

Circular yellow legends for Emergency stop (2)

Description	Marking	Signaling	Supply voltage	Color	Sold in lots of	Reference	Weight kg/lb
Ø 60 mm/2.362 in. - legend for Emergency stop function	-	-	-	Yellow	5	ZBY9121	0.007/0.015
	EMERGENCY STOP	-	-	Yellow	5	ZBY9320	0.007/0.015
	ARRET D'URGENCE	-	-	Yellow	5	ZBY9120	0.007/0.015
	NOT HALT	-	-	Yellow	5	ZBY9220	0.007/0.015
	PARADA DE EMERGENCIA	-	-	Yellow	5	ZBY9420	0.007/0.015
	ARRESTO DI EMERGENZA	-	-	Yellow	5	ZBY9620	0.007/0.015

(1) For compliance with standard EN/ISO 13850, paragraph 4.4.6, the Emergency Stop function logo has been added.

(2) For other legend models for Emergency stop and Emergency switching off functions, see page 104.

Assembly of other products using:
 Body/contact assemblies: see page 76
 Accessories: see page 101 and 104

Control and signaling units

Harmony XB4, metal

Illuminated Emergency switching off function

Circular yellow legends for Emergency stop

Bellows for harsh environments

Illuminated Emergency switching off function only, mechanical latching pushbuttons (1)

Screw clamp terminal connections (Schneider Electric anti-loosening system)

Shape of head	Type of reset	Push Ø (mm)/in.	Color	Reference	Weight kg/lb
Heads only (2)					
	Push-pull	40/1.575	Red	ZB4BW643	0.051/0.112



ZB4BW643



Circular yellow legends for ZB4BW643

Diameter mm/in.	Conforming to standards	Marking on yellow background	Sold in lots of	Unit reference	Weight kg/lb
Used for "Emergency switching off" function					
60/2.362	EN/IEC 60204-1	–	10	ZBY9101 (3)	0.004/0.009
		COUPURE D'URGENCE	10	ZBY9160	0.004/0.009
		EMERGENCY SWITCHING OFF	10	ZBY9360	0.004/0.009
		NOT-AUS	10	ZBY9260	0.004/0.009
		DESCONEXION DE EMERGENCIA	10	ZBY9460	0.004/0.009
90/3.543	EN/IEC 60204-1	–	10	ZBY8101 (3)	0.008/0.018
		COUPURE D'URGENCE	10	ZBY8160	0.008/0.018
		EMERGENCY SWITCHING OFF	10	ZBY8360	0.008/0.018
		NOT-AUS	10	ZBY8260	0.008/0.018
		DESCONEXION DE EMERGENCIA	10	ZBY8460	0.008/0.018
		INTERRUZIONE DI EMERGENZA	10	ZBY8660	0.008/0.018



ZBY9160

Bellows for harsh environments (4)

For use in	Material	For use with	Color	Sold in lots of	Unit reference	Weight kg/lb
Environments subject to humidity, dust, high pressure cleaning, etc.	Silicone	Other functions	Black	2	ZBZ28	0.009/0.020
		Emergency stop/ switching off function	Yellow	2	ZBZ58	0.009/0.020



ZBZ58

(1) For recommended maximum number of contacts constituting the body (fixing collar + contact) associated with the head, see page 24.

(2) For use with bodies comprising a light source with integral LED only.

(3) To add customized markings on these references using the web customization tool, see page 5.

(4) Not compatible with Ø 30 mm/1.181 in. pushbutton.

Assembly of other products using:
body/contact assemblies:
see page 76 and 78



ZB4BC580



ZB4BC28001



Contact + ZB4BC28001



Contact + ZB4BC28001RA

Pushbuttons with integrated bellows

Shape of head	Colour of push	Symbol	Reference	Weight kg/lb
Heads only, Ø 37 mm without marking				
Flush 	White	–	ZB4BC180	0.036/0.079
	Black	–	ZB4BC280	0.036/0.079
	Green	–	ZB4BC380	0.036/0.079
	Red	–	ZB4BC480	0.036/0.079
	Yellow	–	ZB4BC580	0.036/0.079
	Blue	–	ZB4BC680	0.036/0.079
	Gray	–	ZB4BC780	0.036/0.079
	Light blue	–	ZB4BC980	0.036/0.079

Heads only, Ø 37 mm with marking (1)

Flush 	Black	Bell	ZB4BC28001	0.036/ 0.079
		0	ZB4BC28021	0.036/ 0.079
	White	I	ZB4BC18023	0.036/ 0.079
	Red	0	ZB4BC48021	0.036/0.079
	Green	I	ZB4BC38023	0.036/0.079

Other versions

Customization with marking at your choice (texts or symbols)
Rotation of head for horizontal mounting of the contact block (1)
Please contact our Customer Care Centre.

(1) Heads are fixed relative to the position of the contact blocks:

- contact blocks are normally used in the "vertical" position.
 - to mount the contact block in the "horizontal" position, it is necessary to order an alternative head with the symbol rotated by 90°. Please add the suffix "RA" in the end of the references for alternative heads of your choice.
- Example: ZB4BC28001 becomes ZB4BC28001RA.

Assembly of other products using body/contact assemblies: see page 76 and 78



ZBZ1902



ZBZ60

Pushbuttons with integrated bellows (continued)

Accessories

Description	Function	Reference	Weight kg/lb
Protective guard in plastic	Protection against accidental operation	ZBZ1902 (1)	0.010/0.022
Boot for contact block ZBE10●, ZBE10●3 and ZBE50● (2)	Protection against liquid and dust ingress	ZBZ60	0.098/ 0.216



(1) For heads with the "RA" suffix (ZB4BC●●●RA) used with a guard, it is necessary to order the dedicated guard ZBZ1902RA.

(2) Restriction for use: refer to the product instruction sheet on www.schneider-electric.com.

Assembly of other products using:
 Body/contact assemblies: see page 76
 Accessories: see page 88

Control and signaling units

Harmony XB4, metal
 Pushbuttons, push-push

Pushbuttons with flush push ⁽¹⁾				
Shape of head	Type of push	Color of push	Reference	Weight kg/lb
Heads only				
	Without cap ⁽²⁾	–	ZB4BH0	0.028/0.062
	Flush ⁽³⁾	White	ZB4BH01	0.029/0.064
		Black	ZB4BH02	0.029/0.064
		Green	ZB4BH03	0.029/0.064
		Red	ZB4BH04	0.029/0.064
		Yellow	ZB4BH05	0.029/0.064
		Blue	ZB4BH06	0.029/0.064

110045



ZB4BH02

Pushbuttons with projecting push ^{(1) (3)}				
Shape of head	Type of push	Color of push	Reference	Weight kg/lb
Heads only				
	Projecting	White	ZB4BH1	0.029/0.064
		Black	ZB4BH2	0.029/0.064
		Green	ZB4BH3	0.029/0.064
		Red	ZB4BH4	0.029/0.064
		Yellow	ZB4BH5	0.029/0.064
		Blue	ZB4BH6	0.029/0.064

110068



ZB4BH6

Heads with black metal bezel

To order, add a **7** to the references selected from above.
 Example: **ZB4BH01** becomes **ZB4BH017**.

- ⁽¹⁾ For recommended maximum number of contacts constituting the body (fixing collar and contact) associated with the head, see page 24.
- ⁽²⁾ Caps to be ordered separately (see page 88)
- ⁽³⁾ To add customized markings on these references using the web customization tool, see page 5.

Assembly of other products using:
 Combined sub-assemblies: see page 82
 Accessories: see page 88

Control and signaling units

Harmony XB4, metal

Illuminated pushbuttons, push-push, with integral LED

Illuminated pushbuttons with flush push (1) (2)

Shape of head	Type of push	Color of lens	Reference	Weight kg/lb
Heads only (3)				
 Protected LED	Flush	White	ZB4BH013	0.026/0.057
		Green	ZB4BH033	0.026/0.057
		Red	ZB4BH043	0.026/0.057
		Orange	ZB4BH053	0.026/0.057
		Yellow	ZB4BH083	0.026/0.057
		Blue	ZB4BH063	0.026/0.057

110051



ZB4BH033

XB4_632_CPSCT16036



ZB4BH083

Illuminated pushbuttons with projecting push (1) (2)

Shape of head	Type of push	Color of lens	Reference	Weight kg/lb
Heads only (3)				
 Protected LED	Projecting	White	ZB4BH13	0.026/0.057
		Green	ZB4BH33	0.026/0.057
		Red	ZB4BH43	0.026/0.057
		Orange	ZB4BH53	0.026/0.057
		Yellow	ZB4BH83	0.026/0.057
		Blue	ZB4BH63	0.026/0.057

110168



ZB4BH63

Heads with black metal bezel

To order, add a 7 to the references selected from above.
 Example: **ZB4BH013** becomes **ZB4BH0137**.

- (1) For recommended maximum number of contacts constituting the body (fixing collar and contact) associated with the head, see page 24.
 (2) To add customized markings on these references using the web customization tool, see page 5.
 (3) For use with bodies comprising a light source with integral LED only.

Assembly of other products using:
 Body/contact assemblies: see page 76
 Accessories: see page 88

Control and signaling units

Harmony XB4, metal



Flush mounted pushbuttons, push-push

XB4_632_CPMFS18254



ZB4FH02

Flush mounted pushbuttons with flush push for Ø 30 mm ⁽¹⁾

Shape of head	Type of push	Color of push	Reference	Weight kg/lb
Heads only				
	Without cap ⁽²⁾	–	ZB4FH0	0.028/0.062
	Flush ⁽³⁾	White	ZB4FH01	0.029/0.064
		Black	ZB4FH02	0.029/0.064
		Green	ZB4FH03	0.029/0.064
		Red	ZB4FH04	0.029/0.064
		Yellow	ZB4FH05	0.029/0.064
		Blue	ZB4FH06	0.029/0.064

XB4_632_CPMFS18256



ZB4FH6

Flush mounted illuminated pushbuttons with projecting push for Ø 30 mm ⁽¹⁾ ⁽³⁾

Shape of head	Type of push	Color of push	Reference	Weight kg/lb
Heads only				
	Projecting	White	ZB4FH1	0.029/0.064
		Black	ZB4FH2	0.029/0.064
		Green	ZB4FH3	0.029/0.064
		Red	ZB4FH4	0.029/0.064
		Yellow	ZB4FH5	0.029/0.064
		Blue	ZB4FH6	0.029/0.064

⁽¹⁾ For recommended maximum number of contacts constituting the body (fixing collar and contact) associated with the head, see page 24.

⁽²⁾ Caps to be ordered separately (see page 88).

⁽³⁾ To add customized markings on these references using the web customization tool, see page 5.

Assembly of other products using:
 Combined sub-assemblies: see page 82
 Accessories: see page 88

Control and signaling units

Harmony XB4, metal

Flush mounted illuminated pushbuttons, push-push,
 with integral LED



ZB4FH033

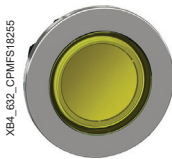

ZB4FH083

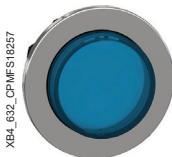

ZB4FH63

Flush mounted illuminated pushbuttons with flush push for Ø 30 mm ^{(1) (2)}

Shape of head	Type of push	Color of lens	Reference	Weight kg/lb
Heads only (3)				
	Flush	White	ZB4FH013	0.026/0.057
		Green	ZB4FH033	0.026/0.057
		Red	ZB4FH043	0.026/0.057
		Orange	ZB4FH053	0.026/0.057
		Blue	ZB4FH063	0.026/0.057
		Yellow	ZB4FH083	0.026/0.057

Flush mounted illuminated pushbuttons with projecting push for Ø 30 mm ^{(1) (2)}

Shape of head	Type of push	Color of lens	Reference	Weight kg/lb
Heads only (3)				
	Projecting	White	ZB4FH13	0.026/0.057
		Green	ZB4FH33	0.026/0.057
		Red	ZB4FH43	0.026/0.057
		Orange	ZB4FH53	0.026/0.057
		Blue	ZB4FH63	0.026/0.057
		Yellow	ZB4FH83	0.026/0.057







(1) For recommended maximum number of contacts constituting the body (fixing collar and contact) associated with the head, see page 24.



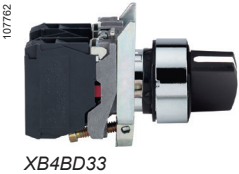



(2) To add customized markings on these references using the web customization tool, see page 5.

(3) For use with bodies comprising a light source with integral LED only.

Assembly of other products using:
 Body/contact assemblies: see page 76
 Accessories: see page 88

Selector switches with standard handle ⁽¹⁾						
Screw clamp terminal connections (Schneider Electric anti-loosening system)						
Shape of head	Type of operator	Type of contact		Positions		Reference
		NO	NC	Number	Type	

Complete units							
	Standard handle, black	1	–	2-position 90°	Stay put	 XB4BD21 (ZB4BZ101 + ZB4BD2)	0.095/0.209
		1	–		Spring return from right to left	 XB4BD41 (ZB4BZ101 + ZB4BD4)	0.100/0.220
		1	1		Stay put	 XB4BD25 (ZB4BZ105 + ZB4BD2)	0.095/0.209
		2	–	3-position ± 45°	Stay put	 XB4BD33 (ZB4BZ103 + ZB4BD3)	0.095/0.209
					Spring return to center	 XB4BD53 (ZB4BZ103 + ZB4BD5)	0.095/0.209

Heads only ⁽²⁾							
	Standard handle, black			2-position 90°	Stay put	 ZB4BD2	0.040/0.088
					Spring return from right to left	 ZB4BD4	0.045/0.099
				3-position ± 45°	Stay put	 ZB4BD3	0.040/0.088
					Spring return to center	 ZB4BD5	0.040/0.088
					Spring return from left to center	 ZB4BD7	0.040/0.088
					Spring return from right to center	 ZB4BD8	0.040/0.088

Heads only with other colored handles		
	Standard handle, white	Add suffix 01 to the reference, example: ZB4BD201
	Standard handle, green	Add suffix 03 to the reference, example: ZB4BD203
	Standard handle, red	Add suffix 04 to the reference, example: ZB4BD204
	Standard handle, yellow	Add suffix 05 to the reference, example: ZB4BD205
	Standard handle, blue	Add suffix 06 to the reference, example: ZB4BD206

Heads with black metal bezel

For heads with standard black handle only. To order, add the suffix 7 to the references selected from above. Example: **ZB4BD2** becomes **ZB4BD27**.



(1) For recommended maximum number of contacts and sequence of contacts constituting the body (fixing collar + contact) associated with the head, see page 24.
 (2) To add customized markings on these references using the web customization tool, see page 5.

Assembly of other products using:
 Body/contact assemblies: see page 76
 Accessories: see page 88

Control and signaling units

Harmony XB4, metal

Selector switches with long handle: normal and padlockable

Selector switches with long handle ⁽¹⁾							
Screw clamp terminal connections (Schneider Electric anti-loosening system)							
Shape of head	Type of operator	Type of contact		Positions		Reference	Weight kg/lb
		NO	NC	Number	Type		
Complete units							
	Long handle, black	1	-	2-position 90°	Stay put	✓ XB4BJ21 (ZB4BZ101 + ZB4BJ2)	0.096/0.212
				3-position ±45°	Stay put	✓ XB4BJ33 (ZB4BZ103 + ZB4BJ3)	0.096/0.212
					Spring return to center	✓ XB4BJ53 (ZB4BZ103 + ZB4BJ5)	0.096/0.212
Heads only							
	Long handle, black (2)	1	-	2-position 90°	Stay put	✓ ZB4BJ2	0.040/0.088
					Spring return from right to left	✓ ZB4BJ4	0.045/0.099
				3-position ±45°	Stay put	✓ ZB4BJ3	0.040/0.088
					Spring return to center	✓ ZB4BJ5	0.040/0.088
					Spring return from left to center	✓ ZB4BJ7	0.040/0.088
					Spring return from right to center	✓ ZB4BJ8	0.040/0.088

Heads with black metal bezel

To order, add a 7 to the references selected from above.
 Example: **ZB4BJ2** becomes **ZB4BJ27**.

(1) For recommended maximum number of contacts and sequence of contacts constituting the body (fixing collar + contact) associated with the head, see page 24.

(2) To add customized markings on these references using the web customization tool, see page 5.

PF1106190

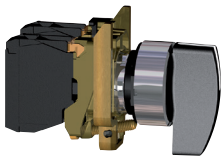

ZB4BJ33

PF1006196



ZB4BJ3

Assembly of other products using:
 Body/contact assemblies: see page 76
 Accessories: see page 88





Control and signaling units

Harmony XB4, metal

Key switches

Key no. 455, 421E, 458A, 520E, 3131A







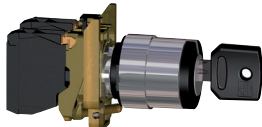











Key switches ^{(1) (2)}						
Screw clamp terminal connections (Schneider Electric anti-loosening system)						
Shape of head	Type of operator	Type of contact		Positions		Reference
		NO	NC	Number	Type	

Complete units							
	Key switch with key no. 455	1	-	2-position 90°	Stay put	 XB4BG21 (ZB4BZ101 + ZB4BG2)	0.153/0.337
					Spring return to left	 XB4BG41 (ZB4BZ101 + ZB4BG4)	0.153/0.337
		2	-	3-position ± 45°	Stay put	 XB4BG03 (ZB4BZ103 + ZB4BG0)	0.153/0.337
						 XB4BG33 (ZB4BZ103 + ZB4BG3)	0.153/0.337

PF106189



XB4BG33

Heads only										
	Key switch with key no. 455 ^{(3) (4)}	2-position 90°	-	2-position 90°	Stay put	 ZB4BG2	0.098/0.216			
						 ZB4BG02	0.098/0.216			
						 ZB4BG4	0.098/0.216			
					Spring return from right to left	 ZB4BG6	0.098/0.216			
					3-position ± 45°	-	3-position ± 45°	Stay put	 ZB4BG0	0.098/0.216
									 ZB4BG03	0.098/0.216
									 ZB4BG04	0.098/0.216
									 ZB4BG3	0.098/0.216
			 ZB4BG5	0.098/0.216						
			 ZB4BG9	0.098/0.216						
			 ZB4BG09	0.098/0.216						
		Spring return from left to center	 ZB4BG1	0.098/0.216						
			 ZB4BG01	0.098/0.216						
		Spring return to center	 ZB4BG7	0.098/0.216						
		Spring return from right to center	 ZB4BG8	0.098/0.216						
			 ZB4BG05	0.098/0.216						
	 ZB4BG08	0.098/0.216								

106189



ZB4BG0

Heads with black metal bezel

To order, add a **7** to the references selected from above. Example: **ZB4BG2** becomes **ZB4BG27**.

(1) For recommended maximum number of contacts and sequence of contacts constituting the body (fixing collar and contact) associated with the head, see page 24.

(2) The symbol  indicates key withdrawal position(s).

(3) Other key numbers:

- Key no. 421E: add suffix **12** to the reference.

- Key no. 458A: add suffix **10** to the reference.

- Key no. 520E: add suffix **14** to the reference.

- Key no. 3131A: add suffix **20** to the reference.

Example: For a switch head with key no. 421E, 2-position stay put, with key withdrawal from the left-hand position, the reference becomes: **ZB4BG212**.

(4) For specific keys with other numbers, please contact our Customer Care Center.











Assembly of other products using:
 Body/contact assemblies: see page 76
 Accessories: see page 88









Control and signaling units



Harmony XB4, metal

Key switches with key TEC10

Selector switches with knurled knob, toggle switches

Key switches with key TEC10						
Shape of head	Type of operator	Positions		Reference	Weight kg/lb	
		Number	Type			
Heads only						
	Key switch with key TEC10	2-position 90°	Stay put		ZB4BG2TEC10	0.160/0.353
					ZB4BG4TEC10	0.160/0.353
			Spring return from right to left		ZB4BG6TEC10	0.170/0.375
					ZB4BG0TEC10	0.160/0.353
		3-position ± 45°	Stay put		ZB4BG3TEC10	0.160/0.353
					ZB4BG5TEC10	0.160/0.353
			Spring return to center		ZB4BG9TEC10	0.160/0.353
					ZB4BG7TEC10	0.170/0.375
			Spring return from right to center		ZB4BG05TEC10	0.170/0.375
						

Selector switches with knurled knob (1)						
Shape of head	Type of operator	Positions		Reference	Weight kg/lb	
		Number	Type			
Heads only						
	Black knurled knob	2-position 90°	Stay put		ZB4BD29	0.043/0.095
					ZB4BD49	0.050/0.110
		3-position ± 45°	Stay put		ZB4BD39	0.040/0.088
					ZB4BD59	0.040/0.088
			Spring return from left to center		ZB4BD79	0.040/0.088
					ZB4BD89	0.040/0.088
			Spring return from right to center			

Toggle switches (1)						
Shape of head	Type of operator	Positions		Reference	Weight kg/lb	
		Number	Type			
Heads only						
	Black lever	2-position 90°	Stay put		ZB4BD28	0.026/0.057
					ZB4BD48	0.026/0.057

Heads with black metal bezel

To order, add a 7 to the references selected from above.
 Example: **ZB4BD29** becomes **ZB4BD297**.

For the references with key TEC10, add the 7 before TEC10.
 Example: **ZB4BG2TEC10** becomes **ZB4BG27TEC10**.

(1) For recommended maximum number of contacts and sequence of contacts constituting the body (fixing collar and contact) associated with the head, see page 24.

PF106198



ZB4BD29

814205







ZB4BD28

Assembly of other products using:
 Combined sub-assemblies: see page 76
 Accessories: see page 88

Control and signaling units

Harmony XB4, metal

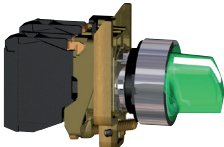
Illuminated selector switches with standard handle,
 with integral LED

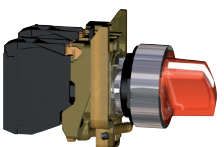
Illuminated selector switches with standard handle, with integral LED ⁽¹⁾													
Screw clamp terminal connections (Schneider Electric anti-loosening system)													
Shape of head	Type of operator	Type of contact	Positions Number Type	Supply voltage V	Color of handle	Reference	Weight kg/lb						
		 NO  NC											
 XB4BK123B5		Standard handle	1	1	2-position Stay put 90°	24 ~ (50/60 Hz) Green XB4BK123B5 (ZB4BW0B35 + ZB4BK1233)	0.101/0.223						
						Red XB4BK124B5 (ZB4BW0B45 + ZB4BK1243)	0.101/0.223						
						Orange XB4BK125B5 (ZB4BW0B55 + ZB4BK1253)	0.101/0.223						
						110...120 ~ (50/60 Hz) Green XB4BK123G5 (ZB4BW0G35 + ZB4BK1233)	0.101/0.223						
						Red XB4BK124G5 (ZB4BW0G45 + ZB4BK1243)	0.101/0.223						
						Orange XB4BK125G5 (ZB4BW0G55 + ZB4BK1253)	0.101/0.223						
						230...240 ~ (50/60 Hz) Green XB4BK123M5 (ZB4BW0M35 + ZB4BK1233)	0.101/0.223						
						Red XB4BK124M5 (ZB4BW0M45 + ZB4BK1243)	0.101/0.223						
						Orange XB4BK125M5 (ZB4BW0M55 + ZB4BK1253)	0.101/0.223						
						 XB4BK134B5		Standard handle	1	1	3-position Stay put ± 45°	24 ~ (50/60 Hz) Green XB4BK133B5 (ZB4BW0B35 + ZB4BK1333)	0.101/0.223
												Red XB4BK134B5 (ZB4BW0B45 + ZB4BK1343)	0.101/0.223
												Orange XB4BK135B5 (ZB4BW0B55 + ZB4BK1353)	0.101/0.223
110...120 ~ (50/60 Hz) Green XB4BK133G5 (ZB4BW0G35 + ZB4BK1333)	0.101/0.223												
Red XB4BK134G5 (ZB4BW0G45 + ZB4BK1343)	0.101/0.223												
Orange XB4BK135G5 (ZB4BW0G55 + ZB4BK1353)	0.101/0.223												
230...240 ~ (50/60 Hz) Green XB4BK133M5 (ZB4BW0M35 + ZB4BK1333)	0.101/0.223												
Red XB4BK134M5 (ZB4BW0M45 + ZB4BK1343)	0.101/0.223												
Orange XB4BK135M5 (ZB4BW0M55 + ZB4BK1353)	0.101/0.223												







(1) For recommended maximum number of contacts constituting the body (fixing collar and contact) associated with the head, see page 24.

Assembly of other products using:
 Combined sub-assemblies: see page 76
 Accessories: see page 88

Control and signaling units

Harmony XB4, metal

Illuminated selector switches with standard handle,
 with integral LED

Illuminated selector switches with standard handle, with integral LED (continued) (1)							
Shape of head	Type of operator	Positions		Color of handle	Reference	Weight kg/lb	
		Number	Type				
Heads only (2)							
	Standard handle	2-position 90°	Stay put		White	ZB4BK1213	0.036/0.079
					Green	ZB4BK1233	0.036/0.079
					Red	ZB4BK1243	0.036/0.079
					Orange	ZB4BK1253	0.036/0.079
					Yellow	ZB4BK1283	0.036/0.079
					Blue	ZB4BK1263	0.036/0.079
			Spring return from right to left		White	ZB4BK1413	0.037/0.082
					Green	ZB4BK1433	0.037/0.082
					Red	ZB4BK1443	0.037/0.082
					Orange	ZB4BK1453	0.037/0.082
					Yellow	ZB4BK1483	0.037/0.082
					Blue	ZB4BK1463	0.037/0.082
		3-position ± 45°	Stay put		White	ZB4BK1313	0.036/0.079
					Green	ZB4BK1333	0.036/0.079
					Red	ZB4BK1343	0.036/0.079
					Orange	ZB4BK1353	0.036/0.079
					Yellow	ZB4BK1383	0.036/0.079
					Blue	ZB4BK1363	0.036/0.079
			Spring return to center		White	ZB4BK1513	0.036/0.079
					Green	ZB4BK1533	0.036/0.079
					Red	ZB4BK1543	0.036/0.079
					Orange	ZB4BK1553	0.036/0.079
					Yellow	ZB4BK1583	0.036/0.079
					Blue	ZB4BK1563	0.036/0.079
Spring return from right to center		White	ZB4BK1813	0.036/0.079			
		Green	ZB4BK1833	0.036/0.079			
		Red	ZB4BK1843	0.036/0.079			
		Orange	ZB4BK1853	0.036/0.079			
		Yellow	ZB4BK1883	0.036/0.079			
		Blue	ZB4BK1863	0.036/0.079			
Spring return from left to center		White	ZB4BK1713	0.036/0.079			
		Green	ZB4BK1733	0.036/0.079			
		Red	ZB4BK1743	0.036/0.079			
		Orange	ZB4BK1753	0.036/0.079			
		Yellow	ZB4BK1783	0.036/0.079			
		Blue	ZB4BK1763	0.036/0.079			



ZB4BK1343

Heads with black metal bezel

To order, add a 7 to the references selected from above.
 Example: **ZB4BK1213** becomes **ZB4BK12137**.

(1) For recommended maximum number of contacts constituting the body (fixing collar and contact) associated with the head, see page 24.



(2) For use with bodies comprising a light source with integral LED only.

Assembly of other products using:
 Body/contact assemblies: see page 76
 Accessories: see page 88

Control and signaling units

Harmony XB4, metal

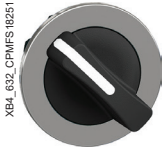
Flush mounted selector switches with standard handle

Flush mounted selector switches with standard handle for Ø 30 mm ⁽¹⁾									
Screw clamp terminal connections (Schneider Electric anti-loosening system)									
Shape of head	Type of operator	Type of contact	Marking on bezel	Positions		Reference	Weight kg/lb		
		NO	NC	Text (color)	Number	Type			
Complete units ⁽²⁾									
	Standard handle, black	1	–	–	2-position 90°	Stay put	✓	XB4FD21 (ZB4BZ101 + ZB4FD2)	0.095/0.209
		1	–	–		Spring return from right to left	↶	XB4FD41 (ZB4BZ101 + ZB4FD4)	0.100/0.220
		1	1	–		Stay put	✓	XB4FD25 (ZB4BZ105 + ZB4FD2)	0.095/0.209
		2	–	–	3-position ± 45°	Stay put	↓	XB4FD33 (ZB4BZ103 + ZB4FD3)	0.095/0.209
		2	–	–		Spring return to center	↕	XB4FD53 (ZB4BZ103 + ZB4FD5)	0.095/0.209
Heads only ⁽²⁾									
	Standard handle, black			–	2-position 90°	Stay put	✓	ZB4FD2	0.040/0.088
						Spring return from right to left	↶	ZB4FD4	0.045/0.099
					3-position ± 45°	Stay put	↓	ZB4FD3	0.040/0.088
						Spring return to center	↕	ZB4FD5	0.040/0.088
						Spring return from left to center	↷	ZB4FD7	0.040/0.088
				Spring return from right to center	↶	ZB4FD8	0.040/0.088		
Heads only with marked bezel									
	Standard handle, black			"O" and "I"	2-position 90°	Stay put		ZB4FD2M178	0.040/0.088
Heads only with other colored handles									
	Standard handle, white							Add suffix 01 to the reference, example: ZB4FD201	
	Standard handle, green							Add suffix 03 to the reference, example: ZB4FD203	
	Standard handle, red							Add suffix 04 to the reference, example: ZB4FD204	
	Standard handle, yellow							Add suffix 05 to the reference, example: ZB4FD205	
	Standard handle, blue							Add suffix 06 to the reference, example: ZB4FD206	

(1) For recommended maximum number of contacts and sequence of contacts constituting the body (fixing collar + contact) associated with the head, see page 24.











(2) To add customized markings on these references using the web customization tool, see page 5.

Assembly of other products using:
 Body/contact assemblies: see page 76
 Accessories: see page 88

Control and signaling units

Harmony XB4, metal

Flush mounted selector switches with long handle:
 normal and padlockable

Flush mounted selector switches with long handle for Ø 30 mm ⁽¹⁾							
Screw clamp terminal connections (Schneider Electric anti-loosening system)							
Shape of head	Type of operator	Type of contact		Positions		Reference	Weight kg/lb
		NO	NC	Number	Type		
Complete units ⁽²⁾							
	Long handle, black ⁽³⁾	1	-	2-position 90°	Stay put	 XB4FJ21 (ZB4BZ101 + ZB4FJ2)	0.096/0.212
				3-position ± 45°	Stay put	 XB4FJ33 (ZB4BZ103 + ZB4FJ3)	0.096/0.212
					Spring return to center	 XB4FJ53 (ZB4BZ103 + ZB4FJ5)	0.096/0.212
Heads only							
	Long handle, black ⁽³⁾	1	-	2-position 90°	Stay put	 ZB4FJ2	0.040/0.088
					Spring return from right to left	 ZB4FJ4	0.045/0.099
				3-position ± 45°	Stay put	 ZB4FJ3	0.040/0.088
					Spring return to center	 ZB4FJ5	0.040/0.088
					Spring return from left to center	 ZB4FJ7	0.040/0.088
					Spring return from right to center	 ZB4FJ8	0.040/0.088



(1) For recommended maximum number of contacts and sequence of contacts constituting the body (fixing collar + contact) associated with the head, see page 24.

(2) To add customized markings on these references using the web customization tool, see page 5.

(3) The symbol  indicates the padlocking positions.







Assembly of other products using:
 Body/contact assemblies: see page 76
 Accessories: see page 88

















Control and signaling units

Harmony XB4, metal

Flush mounted key switches with key no. 455

Flush mounted key switches for Ø 30 mm (1) (2)							
Screw clamp terminal connections (Schneider Electric anti-loosening system)							
Shape of head	Type of operator	Type of contact		Positions		Reference	Weight kg/lb
		NO	NC	Number	Type		

Complete units (5)							
	Key switch with key no. 455	1	-	2-position 90°	Stay put	 XB4FG21 (ZB4BZ101 + ZB4FG2)	0.153/0.337
						 XB4FG41 (ZB4BZ101 + ZB4FG4)	0.153/0.337
		2	-	3-position ± 45°	Stay put	 XB4FG61 (ZB4BZ101 + ZB4FG6)	0.153/0.337
						 XB4FG03 (ZB4BZ103 + ZB4FG0)	0.153/0.337
						 XB4FG33 (ZB4BZ103 + ZB4FG3)	0.153/0.337

Heads only										
	Key switch with key no. 455 (3) (4)			2-position 90°	Stay put	 ZB4FG2 (5)	0.098/0.216			
						 ZB4FG02 (5)	0.098/0.216			
						 ZB4FG4 (5)	0.098/0.216			
				3-position ± 45°	Stay put			Spring return from right to left	 ZB4FG6 (5)	0.098/0.216
									 ZB4FG0 (5)	0.098/0.216
									 ZB4FG03	0.098/0.216
								Spring return from left to center	 ZB4FG04	0.098/0.216
									 ZB4FG3 (5)	0.098/0.216
									 ZB4FG5	0.098/0.216
								Spring return to center	 ZB4FG9 (5)	0.098/0.216
									 ZB4FG09	0.098/0.216
									 ZB4FG1	0.098/0.216
								Spring return from right to center	 ZB4FG01	0.098/0.216
									 ZB4FG7 (5)	0.098/0.216
									 ZB4FG8 (5)	0.098/0.216
	Stay put				 ZB4FG05 (5)	0.098/0.216				
					 ZB4FG08 (5)	0.098/0.216				

(1) For recommended maximum number of contacts and sequence of contacts constituting the body (fixing collar and contact) associated with the head, see page 24.

(2) The symbol  indicates key withdrawal position(s).

(3) Other key numbers:

- Key no. 421E: add suffix **12** to the reference.
- Key no. 458A: add suffix **10** to the reference.
- Key no. 520E: add suffix **14** to the reference.
- Key no. 3131A: add suffix **20** to the reference.

Example: For a switch head with key no. 421E, 2-position stay put, with key withdrawal from the left-hand position, the reference becomes: **ZB4BG212**.

(4) For specific keys with other numbers, please contact our Customer Care Center.

(5) To add customized markings on these references using the web customization tool, see page 5.

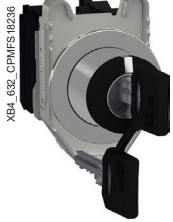

XB4FG33



ZB4FG0

Assembly of other products using:
 Body/contact assemblies: see page 76
 Accessories: see page 88

Control and signaling units

Harmony XB4, metal

Key switches with key TEC10

Flush mounted selector switches with knurled knob



ZB4FD29

Selector switches with knurled knob (1)							
Shape of head	Type of operator	Positions		Reference	Weight kg/lb		
		Number	Type				
Heads only							
	Black knurled knob	2-position 90°	Stay put		ZB4FD29	0.043/0.095	
					3-position ± 45°	Stay put	
		Spring return to center		ZB4FD59 (2)			
				Spring return from left to center		ZB4FD79	0.040/0.088
						Spring return from right to center	

(1) For recommended maximum number of contacts and sequence of contacts constituting the body (fixing collar and contact) associated with the head, see page 24.

(2) To add customized markings on these references using the web customization tool, see page 5.

References

Assembly of other products using:
 Combined sub-assemblies: see page 76
 Accessories: see page 88

Control and signaling units

Harmony XB4, metal

Flush mounted illuminated selector switches with
 standard handle, with integral LED

Flush mounted illuminated selector switches with standard handle, with integral LED for Ø 30 mm (1)

Screw clamp terminal connections (Schneider Electric anti-loosening system)

Shape of head	Type of operator	Type of contact		Positions Number Type	Supply voltage V	Color of handle	Reference	Weight kg/lb					
													
Complete units													
 XB4FK123B5	Standard handle	1	1	2-position Stay put  90°	24 ~ (50/60 Hz)	Green	XB4FK123B5 (2) (ZB4BW0B35 + ZB4FK1233)	0.101/0.223					
						Red	XB4FK124B5 (2) (ZB4BW0B45 + ZB4FK1243)	0.101/0.223					
						Orange	XB4FK125B5 (2) (ZB4BW0B55 + ZB4FK1253)	0.101/0.223					
						110...120 ~ (50/60 Hz)	Green	XB4FK123G5 (2) (ZB4BW0G35 + ZB4FK1233)	0.101/0.223				
						Red	XB4FK124G5 (ZB4BW0G45 + ZB4FK1243)	0.101/0.223					
						Orange	XB4FK125G5 (2) (ZB4BW0G55 + ZB4FK1253)	0.101/0.223					
						230...240 ~ (50/60 Hz)	Green	XB4FK123M5 (2) (ZB4BW0M35 + ZB4FK1233)	0.101/0.223				
						Red	XB4FK124M5 (2) (ZB4BW0M45 + ZB4FK1243)	0.101/0.223					
						Orange	XB4FK125M5 (2) (ZB4BW0M55 + ZB4FK1253)	0.101/0.223					
						 XB4FK134B5	1	1	3-position Stay put  ± 45°	24 ~ (50/60 Hz)	Green	XB4FK133B5 (2) (ZB4BW0B35 + ZB4FK1333)	0.101/0.223
											Red	XB4FK134B5 (ZB4BW0B45 + ZB4FK1343)	0.101/0.223
											Orange	XB4FK135B5 (ZB4BW0B55 + ZB4FK1353)	0.101/0.223
110...120 ~ (50/60 Hz)	Green	XB4FK133G5 (ZB4BW0G35 + ZB4FK1333)	0.101/0.223										
Red	XB4FK134G5 (ZB4BW0G45 + ZB4FK1343)	0.101/0.223											
Orange	XB4FK135G5 (ZB4BW0G55 + ZB4FK1353)	0.101/0.223											
230...240 ~ (50/60 Hz)	Green	XB4FK133M5 (2) (ZB4BW0M35 + ZB4FK1333)	0.101/0.223										
Red	XB4FK134M5 (ZB4BW0M45 + ZB4FK1343)	0.101/0.223											
Orange	XB4FK135M5 (ZB4BW0M55 + ZB4FK1353)	0.101/0.223											

(1) For recommended maximum number of contacts constituting the body (fixing collar and contact) associated with the head, see page 24.

(2) To add customized markings on these references using the web customization tool, see page 5.







Assembly of other products using:
 Combined sub-assemblies: see page 76
 Accessories: see page 88

Control and signaling units

Harmony XB4, metal

Flush mounted illuminated selector switches with standard handle, with integral LED

Flush mounted illuminated selector switches with standard handle, with integral LED for Ø 30 mm (continued) (1)

Shape of head	Type of operator	Positions		Color of handle	Reference	Weight kg/lb		
		Number	Type					
Heads only (2)								
 ZB4FK1343	Protected LED	Standard handle	2-position 90°	Stay put		White	ZB4FK1213 (3)	0.036/0.079
						Green	ZB4FK1233 (3)	0.036/0.079
						Red	ZB4FK1243 (3)	0.036/0.079
						Orange	ZB4FK1253 (3)	0.036/0.079
						Blue	ZB4FK1263 (3)	0.036/0.079
						Yellow	ZB4FK1283 (3)	0.036/0.079
			Spring return from right to left		White	ZB4FK1413 (3)	0.037/0.082	
					Green	ZB4FK1433 (3)	0.037/0.082	
					Red	ZB4FK1443 (3)	0.037/0.082	
					Orange	ZB4FK1453 (3)	0.037/0.082	
					Blue	ZB4FK1463	0.037/0.082	
					Yellow	ZB4FK1483 (3)	0.037/0.082	
			3-position ± 45°	Stay put		White	ZB4FK1313 (3)	0.036/0.079
						Green	ZB4FK1333 (3)	0.036/0.079
						Red	ZB4FK1343 (3)	0.036/0.079
						Orange	ZB4FK1353 (3)	0.036/0.079
						Blue	ZB4FK1363 (3)	0.036/0.079
						Yellow	ZB4FK1383 (3)	0.036/0.079
Spring return to center		White	ZB4FK1513 (3)	0.036/0.079				
		Green	ZB4FK1533 (3)	0.036/0.079				
		Red	ZB4FK1543 (3)	0.036/0.079				
		Orange	ZB4FK1553 (3)	0.036/0.079				
		Blue	ZB4FK1563 (3)	0.036/0.079				
		Yellow	ZB4FK1583 (3)	0.036/0.079				
Spring return from right to center		White	ZB4FK1813 (3)	0.036/0.079				
		Green	ZB4FK1833 (3)	0.036/0.079				
		Red	ZB4FK1843	0.036/0.079				
		Orange	ZB4FK1853 (3)	0.036/0.079				
		Blue	ZB4FK1863	0.036/0.079				
		Yellow	ZB4FK1883 (3)	0.036/0.079				
Spring return from left to center		White	ZB4FK1713 (3)	0.036/0.079				
		Green	ZB4FK1733 (3)	0.036/0.079				
		Red	ZB4FK1743 (3)	0.036/0.079				
		Orange	ZB4FK1753 (3)	0.036/0.079				
		Blue	ZB4FK1763	0.036/0.079				
		Yellow	ZB4FK1783 (3)	0.036/0.079				

(1) For recommended maximum number of contacts constituting the body (fixing collar and contact) associated with the head, see page 24.

(2) For use with bodies comprising a light source with integral LED only.

(3) To add customized markings on these references using the web customization tool, see page 5.

Assembly of other products using:
 Body/light assemblies: see page 84
 Accessories: see page 88

Control and signaling units

Harmony XB4, metal
 Pilot lights with integral LED

Pilot lights with integral LED ⁽¹⁾				
Screw clamp terminal connections (Schneider Electric anti-loosening system)				
Shape of head	Supply voltage V	Color	Reference	Weight kg/lb
Complete units				
■ With plain lens				
 101179 XB4BVB5 	24 ~ (50/60 Hz)	White	XB4BVB1 (ZB4BVB1 + ZB4BV013)	0.080/0.176
		Green	XB4BVB3 (ZB4BVB3 + ZB4BV033)	0.080/0.176
		Red	XB4BVB4 (ZB4BVB4 + ZB4BV043)	0.080/0.176
		Orange	XB4BVB5 (ZB4BVB5 + ZB4BV053)	0.080/0.176
		Blue	XB4BVB6 (ZB4BVB6 + ZB4BV063)	0.080/0.176
		110...120 ~ (50/60 Hz)	White	XB4BVG1 (ZB4BVG1 + ZB4BV013)
	Green	XB4BVG3 (ZB4BVG3 + ZB4BV033)	0.080/0.176	
	Red	XB4BVG4 (ZB4BVG4 + ZB4BV043)	0.080/0.176	
	Orange	XB4BVG5 (ZB4BVG5 + ZB4BV053)	0.080/0.176	
	Blue	XB4BVG6 (ZB4BVG6 + ZB4BV063)	0.080/0.176	
	230...240 ~ (50/60 Hz)	White	XB4BVM1 (ZB4BVM1 + ZB4BV013)	0.080/0.176
	Green	XB4BVM3 (ZB4BVM3 + ZB4BV033)	0.080/0.176	
	Red	XB4BVM4 (ZB4BVM4 + ZB4BV043)	0.080/0.176	
	Orange	XB4BVM5 (ZB4BVM5 + ZB4BV053)	0.080/0.176	
	Blue	XB4BVM6 (ZB4BVM6 + ZB4BV063)	0.080/0.176	

(1) To add customized markings on these references using the web customization tool, see page 5.

Control and signaling units

Harmony XB4, metal

Pilot lights with integral LED

Pilot lights with integral LED							
Screw clamp terminal connections (Schneider Electric anti-loosening system)							
Heads only (1)							
Shape of head	For use with body comprising light source type	Color of lens	Reference	Weight kg/lb			
■ With plain lens							
 101233 ZB4BV063		Integral LED only	White	ZB4BV013 (2)	0.026/0.057		
			Green	ZB4BV033 (2)	0.026/0.057		
			Red	ZB4BV043 (2)	0.026/0.057		
			Orange	ZB4BV053 (2)	0.026/0.057		
			Yellow	ZB4BV083 (2)	0.026/0.057		
			Blue	ZB4BV063 (2)	0.026/0.057		
 XB4_632_CPSCCT16037 ZB4BV083			5 colors (3) (4)	ZB4BV003	0.026/0.057		
		■ With plain lens, for insertion of legend (4)					
		 101234 ZB4BV043S		Integral LED only	White	ZB4BV013E	0.026/0.057
					Green	ZB4BV033E	0.026/0.057
					Red	ZB4BV043E	0.026/0.057
	Orange			ZB4BV053E	0.026/0.057		
	Yellow			ZB4BV083E	0.026/0.057		
	Blue			ZB4BV063E	0.026/0.057		
■ With grooved lens (5) (2)							
 101234 ZB4BV043S		Integral LED only	White	ZB4BV013S	0.026/0.057		
			Green	ZB4BV033S	0.026/0.057		
			Red	ZB4BV043S	0.026/0.057		
			Orange	ZB4BV053S	0.026/0.057		
			Yellow	ZB4BV083S	0.026/0.057		
			Blue	ZB4BV063S	0.026/0.057		

(1) For use with bodies comprising a light source with integral LED only.

(2) To add customized markings on these references using the web customization tool, see page 5.

(3) Head supplied with 5 different colored lenses (white, green, red, orange, and blue) not fitted, for insertion of legend.

(4) For legend ordering information, see page 97.

(5) For use in bright ambient light conditions (for example, outdoors in sunlight).

Assembly of other products using:
 Body/light assemblies: see page 84
 Accessories: see page 88

Control and signaling units

Harmony XB4, metal

Pilot lights with integral LED and with BA 9s base fitting

Pilot lights with integral LED and transformer (1.2 VA, 24 V secondary) (1)

Screw clamp terminal connections (Schneider Electric anti-loosening system)

Shape of head	Supply voltage V	Color	Reference	Weight kg/lb
Complete units - With plain lens				
	400 ~ - 50 Hz (2)	White	XB4BV5B1	0.172/0.379
		Green	XB4BV5B3	0.172/0.379
		Red	XB4BV5B4	0.172/0.379
		Orange	XB4BV5B5	0.172/0.379
		Blue	XB4BV5B6	0.172/0.379

PF512544

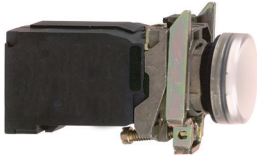



XB4BV5B1

**Protected
LED**

Pilot lights with BA 9s base fitting, with plain or grooved lens (1)

Screw clamp terminal connections (Schneider Electric anti-loosening system)

Shape of head	Supply voltage V	Color	Reference	Weight kg/lb
Complete units - With plain lens				
■ Direct supply, for BA 9s bulb, U ≤ 250 V, 2.4 W max (bulb not included)				
	≤ 250	White	XB4BV61 (ZB4BV6 + ZB4BV01)	0.075/0.165
		Green	XB4BV63 (ZB4BV6 + ZB4BV03)	0.075/0.165
		Red	XB4BV64 (ZB4BV6 + ZB4BV04)	0.075/0.165
		Orange	XB4BV65 (ZB4BV6 + ZB4BV05)	0.075/0.165
■ Via integral transformer, 1.2 VA, 6 V secondary, with BA 9s incandescent bulb (included)				
	110...120 ~ - 50/60 Hz	White	XB4BV31 (ZB4BV3 + ZB4BV01)	0.152/0.335
		Green	XB4BV33 (ZB4BV3 + ZB4BV03)	0.152/0.335
		Red	XB4BV34 (ZB4BV3 + ZB4BV04)	0.152/0.335
		Orange	XB4BV35 (ZB4BV3 + ZB4BV05)	0.152/0.335
	230 ~ - 50 Hz	White	XB4BV41 (ZB4BV4 + ZB4BV01)	0.152/0.335
	220...240 ~ - 60 Hz	Green	XB4BV43 (ZB4BV4 + ZB4BV03)	0.152/0.335
		Red	XB4BV44 (ZB4BV4 + ZB4BV04)	0.152/0.335
		Orange	XB4BV45 (ZB4BV4 + ZB4BV05)	0.152/0.335

101176-88-Q

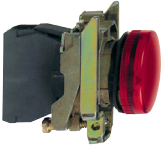

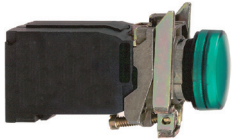

XB4BV64

PF512545-88-Q



XB4BV33

Heads only (3)

Shape of head	For use with body comprising light source type	Color of lens	Reference	Weight kg/lb
■ With plain lens				
	With BA 9s base fitting	White	ZB4BV01	0.027/0.060
		Green	ZB4BV03	0.027/0.060
		Red	ZB4BV04	0.027/0.060
		Orange	ZB4BV05	0.027/0.060
		Blue	ZB4BV06	0.027/0.060
		Clear	ZB4BV07	0.027/0.060
■ With grooved lens (4)				
	With BA 9s base fitting	White	ZB4BV01S	0.027/0.060
		Green	ZB4BV03S	0.027/0.060
		Red	ZB4BV04S	0.027/0.060
		Orange	ZB4BV05S	0.027/0.060
		Blue	ZB4BV06S	0.027/0.060
		Clear	ZB4BV07S	0.027/0.060

101234



ZB4BV04

PG113109-34-Q



ZB4BV06S

(1) To add customized markings on these references using the web customization tool, see page 5.

(2) To order 440...460 V ~ - 60 Hz transformer blocks, replace "5" in the reference with "8". Example: **XB4BV5B1** becomes **XB4BV8B1**. To order 550...600 V ~ - 60 Hz blocks, replace "5" with "9". Example: **XB4BV5B1** becomes **XB4BV9B1**.

(3) For use with bodies comprising a light source with BA 9s base fitting (incandescent, neon, or LED) only.

(4) For use in bright ambient light conditions (for example, outdoors in sunlight).

Assembly of other products using:
 Body/light assemblies: see page 84
 Accessories: see page 88

Control and signaling units

Harmony XB4, metal

Push-to-test pilot light



Push-to-test pilot light				
Shape of head	Supply voltage V	Color	Reference	Weight kg/lb
Complete units - With plain lens				
	24 ~ - 50/60 Hz	White	XB4BW21B5	0.090/0.198
	24 ~ - 50/60 Hz	Green	XB4BW23B5	0.090/0.198
	24 ~ - 50/60 Hz	Red	XB4BW24B5	0.090/0.198
	24 ~ - 50/60 Hz	Orange	XB4BW25B5	0.090/0.198
	24 ~ - 50/60 Hz	Yellow	XB4BW28B5	0.090/0.198
	24 ~ - 50/60 Hz	Blue	XB4BW26B5	0.090/0.198
	110...120 ~ - 50 - 60 Hz	White	XB4BW21G5	0.090/0.198
	110...120 ~ - 50 - 60 Hz	Green	XB4BW23G5	0.090/0.198
	110...120 ~ - 50 - 60 Hz	Red	XB4BW24G5	0.090/0.198
	110...120 ~ - 50 - 60 Hz	Orange	XB4BW25G5	0.090/0.198
	110...120 ~ - 50 - 60 Hz	Yellow	XB4BW28G5	0.090/0.198
	110...120 ~ - 50 - 60 Hz	Blue	XB4BW26G5	0.090/0.198

Assembly of other products using:
 Body/light assemblies: see page 84
 Accessories: see page 88

Control and signaling units

Harmony XB4, metal

Flush mounted pilot lights with integral LED



XB4FVB5

Flush mounted pilot lights with integral LED for Ø 30 mm (1) Screw clamp terminal connections (Schneider Electric anti-loosening system)

Shape of head	Supply voltage V	Color	Reference	Weight kg/lb
Complete units				
■ With plain lens				
	24 ~ (50/60 Hz)	White	XB4FVB1 (ZB4BVB1 + ZB4FV013)	0.080/0.176
		Green	XB4FVB3 (ZB4BVB3 + ZB4FV033)	0.080/0.176
		Red	XB4FVB4 (ZB4BVB4 + ZB4FV043)	0.080/0.176
		Orange	XB4FVB5 (ZB4BVB5 + ZB4FV053)	0.080/0.176
		Blue	XB4FVB6 (ZB4BVB6 + ZB4FV063)	0.080/0.176
		110...120 ~ (50/60 Hz)	White	XB4FVG1 (ZB4BVG1 + ZB4FV013)
	Green		XB4FVG3 (ZB4BVG3 + ZB4FV033)	0.080/0.176
	Red		XB4FVG4 (ZB4BVG4 + ZB4FV043)	0.080/0.176
	Orange		XB4FVG5 (ZB4BVG5 + ZB4FV053)	0.080/0.176
	Blue		XB4FVG6 (ZB4BVG6 + ZB4FV063)	0.080/0.176
	230...240 ~ (50/60 Hz)		White	XB4FVM1 (ZB4BVM1 + ZB4FV013)
		Green	XB4FVM3 (ZB4BVM3 + ZB4FV033)	0.080/0.176
		Red	XB4FVM4 (ZB4BVM4 + ZB4FV043)	0.080/0.176
		Orange	XB4FVM5 (ZB4BVM5 + ZB4FV053)	0.080/0.176
		Blue	XB4FVM6 (ZB4BVM6 + ZB4FV063)	0.080/0.176

(1) To add customized markings on these references using the web customization tool, see page 5.

Assembly of other products using:
 Body/light assemblies: see page 84
 Accessories: see page 88

Control and signaling units

Harmony XB4, metal

Flush mounted pilot lights with integral LED

Flush mounted pilot lights with integral LED for Ø 30 mm (1) Screw clamp terminal connections (Schneider Electric anti-loosening system)

Heads only (2)

Shape of head	For use with body comprising light source type	Color of lens	Reference	Weight kg/lb
	Integral LED only	White	ZB4FV013	0.026/0.057
		Green	ZB4FV033	0.026/0.057
		Red	ZB4FV043	0.026/0.057
		Orange	ZB4FV053	0.026/0.057
		Blue	ZB4FV063	0.026/0.057
		Yellow	ZB4FV083	0.026/0.057



ZB4FV063

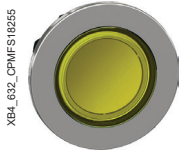

ZB4FV083

(1) To add customized markings on these references using the web customization tool, see page 5.

(2) For use with bodies comprising a light source with integral LED only.

Assembly of other products using:
 Body/contact assemblies: see page 76
 Accessories: see page 88

Control and signaling units

Harmony XB4, metal

Specific functions

Pushbuttons for manual overload reset, Potentiometers

Manual overload reset pushbuttons					
Shape of head	Travel mm/in.	Actuation distance mm/in.	Color	Reference	Weight kg/lb
With flush push					
	10/0.394	6...16/0.236...0.630	Black	XB4BA821	0.037/0.082
			Red	XB4BA841	0.037/0.082
			Blue	XB4BA861	0.037/0.082
	16...26/0.630...1.024	30...130/1.181...5.118	Black	XB4BA822	0.038/0.084
			Red	XB4BA842	0.038/0.084
			Blue	XB4BA862	0.038/0.084
	40/0.551	130...257/5.118...10.118	Black	XB4BA921	0.058/0.128
			Red	XB4BA941	0.058/0.128
			Blue	XB4BA961	0.058/0.128
			Black	XB4BA922	0.071/0.157
			Red	XB4BA942	0.071/0.157
			Blue	XB4BA962	0.071/0.157



XB4BA821

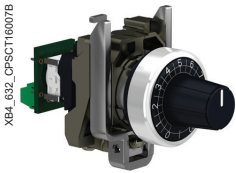

XB4BD912R1K

Complete potentiometers			
Description	Resistance k Ω	Reference	Weight kg/lb
+/- 10% linear mode precision complete potentiometer with screw terminals	1	XB4BD912R1K	0.095/0.209
	4.7	XB4BD912R4K7	0.095/0.209
	10	XB4BD912R10K	0.095/0.209
	47	XB4BD912R47K	0.095/0.209
	100	XB4BD912R100K	0.095/0.209
	470	XB4BD912R470K	0.095/0.209

Heads and mounting base for potentiometer (1)				
Shape of head	Description	For use with	Reference	Weight kg/lb
	For potentiometer with shaft length 45 to 50 mm/1.772 to 1.968 in.	6 mm/0.236 in. shaft	ZB4BD912	0.080/0.176
		6.35 mm/0.250 in. shaft	ZB4BD922	0.080/0.176

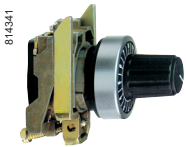

ZB4BD912

Assembly of other products using:
Accessories: see page 88

Control and signaling units

Harmony XB4, metal

Specific functions

Joystick controllers

10189

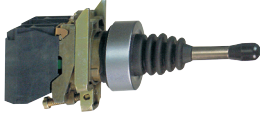

XD4PA12

Joystick controllers (with 54 mm/2.126 in. long operating shaft) (1)

Screw clamp terminal connections (Schneider Electric anti-loosening system)

Description	Operation	Spring return to zero position	Reference	Weight kg/lb
Complete products				
2-direction	1 notch 1 NO contact per direction	Without	XD4PA12	0.116/0.256
		With	XD4PA22	0.116/0.256
4-direction	1 notch 1 NO contact per direction	Without	XD4PA14	0.133/0.293
		With	XD4PA24	0.133/0.293

103074

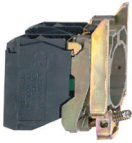

ZD4PA103

Sub-assemblies for joystick controllers

Description	Functions	Reference	Weight kg/lb
Complete body/contact assemblies	2-direction	ZD4PA103	0.049/0.108
	4-direction	ZD4PA203	0.058/0.128

103072

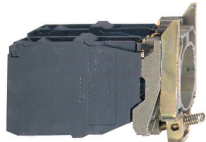

ZD4PA203

Complete head assemblies with operating shaft	2-direction, stay put	ZD4PA12	0.022/0.049
	2-direction, spring return to zero position	ZD4PA22	0.022/0.049
	4-direction, stay put	ZD4PA14	0.022/0.049
	4-direction, spring return to zero position	ZD4PA24	0.022/0.049

103073



ZD4PA12

Legends 30 x 48 mm/ 1.181 x 1.890 in. for engraving	2-direction	Black on one side Red on reverse	ZBG2201	0.001/0.002
		White on one side Yellow on reverse	ZBG2401	0.001/0.002
Legends 48 x 48 mm/ 1.890 x 1.890 in. for engraving	4-direction	Black on one side Red on reverse	ZBG4201	0.002/0.004
		White on one side Yellow on reverse	ZBG4401	0.002/0.004

Other versions Joystick controllers and complete body/contact assemblies for joystick controllers with Faston connector terminals (6.35 or 2 x 2.8 mm/0.250 or 2 x 0.110 in.). Please contact our Customer Care Center.

(1) Must not be used with standard contact blocks **ZBE10** (single) or **ZBE20** (double).

Control and signaling units

Harmony XB4, metal

Specific functions

Wobblesticks

109487



ZB4BB2

Wobblestick heads				
Shape of head	For use with	Color	Reference	Weight kg/lb
	Omnidirectional, spring return	Black	ZB4BB2	0.058/0.128
		Red	ZB4BB4	0.058/0.128

To combine with heads, see page 26 to 73

101191



ZB4BZ009

2bc203



ZBE203

101274



ZB4BZ101

814346

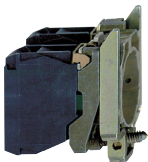

ZB4BZ106

PF080706

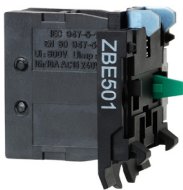

ZBE501

PG1141658E



ZB2BE101

814282

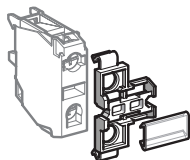

ZBZ001

Body/fixing collar

For use with	Sold in lots of	Unit reference	Weight kg/lb
Electrical block (contact or light)	10	ZB4BZ009	0.038/0.084

Contact functions (1)

Screw clamp terminal connections (Schneider Electric anti-loosening system)

Contacts for standard applications

Description	Type of contact	NO	NC	Sold in lots of	Unit reference	Weight kg/lb	
Contact blocks	Single	1	–	5	ZBE101	0.011/0.024	
		–	1	5	ZBE102	0.011/0.024	
	Double	2	–	5	ZBE203	0.020/0.044	
		–	2	5	ZBE204	0.020/0.044	
	Single with body/fixing collar	1	1	5	ZBE205	0.020/0.044	
		1	–	1	ZB4BZ101	0.053/0.117	
		–	1	1	ZB4BZ102	0.053/0.117	
		2	–	1	ZB4BZ103	0.062/0.137	
		–	2	1	ZB4BZ104	0.062/0.137	
		1	1	1	ZB4BZ105	0.062/0.137	
			1	2	1	ZB4BZ141	0.072/0.159

Contacts for specific applications

Application	Type of contact	Description	NO	NC	Sold in lots of	Unit reference	Weight kg/lb
Low power switching	Single	Standard	1	–	5	ZBE1016	0.012/0.026
			–	1	5	ZBE1026	0.012/0.026
		Dusty environment (2) (IP 5X, 50 µm dust)	1	–	5	ZBE1016P	0.012/0.026
			–	1	5	ZBE1026P	0.012/0.026
Staggered contacts	Single	Early make NO	1	–	5	ZBE201	0.011/0.024
			–	1	5	ZBE202	0.011/0.024
	Single with body/fixing collar	Overlapping NO+NC	1	1	5	ZB4BZ106	0.062/0.137
			2	–	5	ZB4BZ107	0.062/0.137
High power switching	Single	Standard (3)	1	–	1	ZBE501	0.020/0.044
			–	1	1	ZBE502	0.020/0.044
			2	–	1	ZBE503	0.032/0.071
			–	2	1	ZBE504	0.032/0.071
			1	1	1	ZBE505	0.032/0.071
Additional contact blocks for high power switching	Single	Standard (4)	1	–	1	ZB2BE101	0.020/0.044
			–	1	1	ZB2BE102	0.020/0.044

Clip-on legend holder, sheet of blank legends and labelling software

Description	Sold in lots of	Unit reference	Weight kg/lb
Clip-on legend-holder for electrical blocks with screw clamp terminal connections (5). For identification of an XB4B control or signaling unit	10	ZBZ001	0.001/0.002
Sheet of 50 blank legends for legend holder ZBZ001	10	ZBY001	0.023/0.051

- (1) The contact blocks enable variable composition of body/contact assemblies. Maximum number of rows possible: 3. Either 3 rows of 3 single contacts or 1 row of 3 double contacts + 1 row of 3 single contacts (double contacts occupy the first 2 rows). Maximum number of contacts is specified on page 24.
- (2) It is not possible to fit an additional contact block on the back of these contact blocks.
- (3) It is not possible to use these contacts with light blocks.
- (4) To be fitted on the back of ZBE50● contacts.
- (5) This legend holder is not compatible with high power switching contacts.

To combine with heads, see page 31



ZBVB●

Light blocks with screw clamp terminal connections (Schneider Electric anti-loosening system)

Description	Supply voltage V	Color of light source	Sold in lots of	Unit reference	Weight kg/lb
Integral LED (to combine with heads for integral LED)	12 ~ (50/60 Hz)	White	5	ZBVJ1	0.017/0.037
		Green	5	ZBVJ3	0.017/0.037
		Red	5	ZBVJ4	0.017/0.037
		Orange	5	ZBVJ5	0.017/0.037
		Blue	5	ZBVJ6	0.017/0.037
		24 ~ (50/60 Hz)	White	5	ZBVB1
	Green		5	ZBVB3	0.017/0.037
	Red		5	ZBVB4	0.017/0.037
	Orange		5	ZBVB5	0.017/0.037
	Yellow		5	ZBVB8	0.017/0.037
	Blue		5	ZBVB6	0.017/0.037
	24...120 ~ (50/60 Hz)	White	5	ZBVBG1	0.017/0.037
		Green	5	ZBVBG3	0.017/0.037
		Red	5	ZBVBG4	0.017/0.037
		Orange	5	ZBVBG5	0.017/0.037
		Blue	5	ZBVBG6	0.017/0.037
		110...120 ~ (50/60 Hz)	White	5	ZBVG1
	Green		5	ZBVG3	0.017/0.037
Red	5		ZBVG4	0.017/0.037	
Orange	5		ZBVG5	0.017/0.037	
Yellow	5		ZBVG8	0.017/0.037	
Blue	5		ZBVG6	0.017/0.037	
230...240 ~ (50/60 Hz)	White	5	ZBVM1	0.017/0.037	
	Green	5	ZBVM3	0.017/0.037	
	Red	5	ZBVM4	0.017/0.037	
	Orange	5	ZBVM5	0.017/0.037	
	Yellow	5	ZBVM8	0.017/0.037	
	Blue	5	ZBVM6	0.017/0.037	

Protected LED



ZBV5B



ZBZG156



ZBZM156

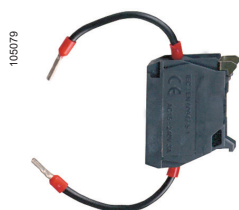

ZBZV●

Flashing light blocks with screw clamp terminal connections (Schneider Electric anti-loosening system)

Description	Supply voltage V	Color of light source	Sold in lots of	Unit reference	Weight kg/lb
Integral LED (to combine with heads for integral LED)	24 ~ (50/60 Hz)	White	5	ZBV18B1	0.017/0.037
		Green	5	ZBV18B3	0.017/0.037
		Red	5	ZBV18B4	0.017/0.037
		Orange	5	ZBV18B5	0.017/0.037
		Blue	5	ZBV18B6	0.017/0.037
		110...120 ~ (50/60 Hz)	White	5	ZBV18G1
	Green		5	ZBV18G3	0.017/0.037
	Red		5	ZBV18G4	0.017/0.037
	Orange		5	ZBV18G5	0.017/0.037
	Blue		5	ZBV18G6	0.017/0.037
	230...240 ~ (50/60 Hz)		White	5	ZBV18M1
		Green	5	ZBV18M3	0.017/0.037
		Red	5	ZBV18M4	0.017/0.037
		Orange	5	ZBV18M5	0.017/0.037
		Blue	5	ZBV18M6	0.017/0.037

Protected LED

Transformer blocks for 24 V light blocks (1)

For use with	Supply voltage V	Description	Référence	Weight kg/lb
Light blocks with integral LED	400 V ~ - 50 Hz	Transformer 400 V - 24 V ~	ZBV5B (2)	0.090/0.198

Blocks for "test light" function

Light blocks	12 and 24 ~ 24...120 ~	Single module, 1 connecting wire	ZBZG156 (3)	0.010/0.022
Light blocks with integral LED	48...230 ~	Double module, with connecting wires	ZBZM156 (4)	0.010/0.022

LED suppressors

For use with	Supply voltage V	Level of protection	Reference	Weight kg/lb
Light blocks with integral LED fitted with screw clamp terminal connections	120 ~	25...120 VA	ZBZVG	0.010/0.022
	230 ~	30...230 VA	ZBZVM	0.010/0.022

(1) To be used with 2 dummy contact blocks ZBE000.

(2) To order 440...460 V ~ - 60 Hz transformer blocks, replace "5" in the reference with "8": ZBV5B becomes ZBV8B. To order 550...600 V ~ - 60 Hz transformer blocks, replace "5" with "9": ZBV5B becomes ZBV9B.

(3) Block for use with ~ light blocks with integral LED types ZBVJ●, ZBVB●, ZBVBG● or with direct supply light block for BA 9s bulb, ZBV6.

(4) Block for use ~ light blocks integral LED types ZBVG●, ZBVM●, see connection on our website www.schneider-electric.com.

To combine with heads, see page 26 to 73



10191

ZB4BZ009



PF10777

ZBE1015

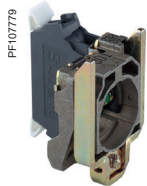

PF10779

ZB4BZ1015

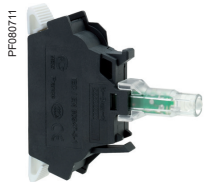

PF080711

ZBVB35

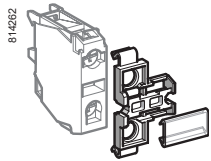

814262

ZBZ001

Body/fixing collar

For use with	Sold in lots of	Unit reference	Weight kg/lb
Electrical block (contact or light)	10	ZB4BZ009	0.038/0.084

Contact functions

Spring clamp terminal connections (1)

Contacts for standard applications

Description	Type of contact			Sold in lots of	Unit reference	Weight kg/lb
		NO	NC			
Contact blocks	Single	1	–	4	ZBE1015	0.011/0.024
		–	1	4	ZBE1025	0.011/0.024
Contact blocks	Single with body/fixing collar	1	–	1	ZB4BZ1015	0.053/0.117
		–	1	1	ZB4BZ1025	0.053/0.117
		2	–	1	ZB4BZ1035	0.062/0.137
		–	2	1	ZB4BZ1045	0.062/0.137
		1	1	1	ZB4BZ1055	0.062/0.137

Light blocks

Spring clamp terminal connections (1)

Description	Supply voltage V	Color of light source	Sold in lots of	Unit reference	Weight kg/lb
Integral LED (to combine with heads for integral LED)	12 ~ (50/60 Hz)	White	4	ZBVJ15	0.016/0.035
		Green	4	ZBVJ35	0.016/0.035
		Red	4	ZBVJ45	0.016/0.035
		Orange	4	ZBVJ55	0.016/0.035
		Blue	4	ZBVJ65	0.016/0.035
		24 ~ (50/60 Hz)	White	4	ZBVB15
Green	4		ZBVB35	0.016/0.035	
Red	4		ZBVB45	0.016/0.035	
Orange	4		ZBVB55	0.016/0.035	
Blue	4		ZBVB65	0.016/0.035	
110...120 ~ (50/60 Hz)	White		4	ZBVG15	0.016/0.035
	Green	4	ZBVG35	0.016/0.035	
	Red	4	ZBVG45	0.016/0.035	
	Orange	4	ZBVG55	0.016/0.035	
	Blue	4	ZBVG65	0.016/0.035	
	230...240 ~ (50/60 Hz)	White	4	ZBVM15	0.016/0.035
Green		4	ZBVM35	0.016/0.035	
Red		4	ZBVM45	0.016/0.035	
Orange		4	ZBVM55	0.016/0.035	
Blue		4	ZBVM65	0.016/0.035	
Integral LED + body/fixing collar		110...120 ~ (50/60 Hz)	Green	4	ZB4BVG35
	Red		4	ZB4BVG45	0.053/0.117

Sheet of 50 blank legends

For use with	Sold in lots of	Unit reference	Weight kg/lb
Legend holder ZBZ001	10	ZBY001	0.023/0.051

(1) It is not possible to fit an additional block on the back of these contact or light blocks.

To combine with heads,
see page 26 to 73

101191



ZB4BZ009

101257

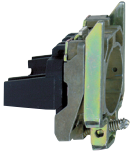

ZB4BZ079 + ZB4BZ009

101303

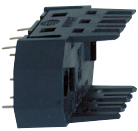

ZBZ01

XB4_632_CPSC11841C



ZBZ110

101259



ZBE701

101260



ZBE702

PF512550



ZBVB07

Body/fixing collar and accessories specifically for printed circuit board mounting ⁽¹⁾

Accessories required when using adaptor (socket) ZBZ010				
Description	For use with	Sold in lots of	Unit reference	Weight kg/lb
Body/fixing collar	Electrical block (contact or light)	10	ZB4BZ009	0.006/0.013
Fixing collar/pillar	Printed circuit board support (fixing screw ZBZ006 to be ordered separately)	10	ZB4BZ079	0.003/0.007
Fixing screw for printed circuit board	Fixing collar/pillar ZB4BZ079	10	ZBZ006	0.011/0.024

Adapter (socket) ⁽¹⁾

For use with	Thickness of printed circuit board (mm)/in.	Sold in lots of	Unit reference	Weight kg/lb
Electrical block (contact or light)	1.6 ± 0.2/0.063 ± 0.008	10	ZBZ010	0.008/0.018
	2.2 ± 0.2/0.087 ± 0.008	10	ZBZ011	0.008/0.018
	3.2 ± 0.2/0.126 ± 0.008	10	ZBZ012	0.008/0.018

Grounding Plate

Description	For use with	Sold in lots of	Unit reference	Weight kg/lb
Grounding plate with ground screw	Harmony XB4 metal and XALG plastic control stations	1	ZBZ110	0.017/0.037

Contact functions ⁽¹⁾

Contacts for standard applications

Description	Type of contact			Sold in lots of	Unit reference	Weight kg/lb
Contact blocks	Single	1	–	5	ZBE701	0.011/0.024
		–	1	5	ZBE702	0.011/0.024

Contacts for specific applications

Application	Type of contact			Sold in lots of	Unit reference	Weight kg/lb
Low power switching	Single	1	–	5	ZBE7016	0.012/0.026
		–	1	5	ZBE7026	0.012/0.026

Light blocks ⁽¹⁾

Description	Supply voltage V	Color of LED	Sold in lots of	Unit reference	Weight kg/lb
Integral LED (to combine with heads for integral LED)	24 ~ (50/60 Hz)	White	5	ZBVB17	0.004/0.009
		Green	5	ZBVB37	0.004/0.009
		Red	5	ZBVB47	0.004/0.009
		Orange	5	ZBVB57	0.004/0.009
		Blue	5	ZBVB67	0.004/0.009

Protected
LED

⁽¹⁾ For details of support drilling and of printed circuit board, see our website www.schneider-electric.com.

To combine with heads, see page 26 to 73



ZBE1023



ZBE2043

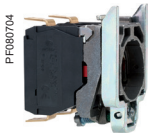

ZB4BZ1043

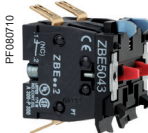

ZBE5043

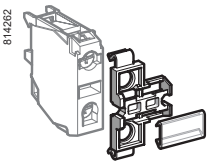

ZBZ001

Contact functions (1)

Faston connectors (6.35 or 2 x 2.8 mm/0.250 or 2 x 0.110 in.) (Schneider Electric anti-loosening system)

Contacts for standard applications

Description	Type of contact			Sold in lots of	Unit reference	Weight kg/lb
		NO	NC			
Contact blocks	Single	1	–	5	ZBE1013	0.011/0.024
		–	1	5	ZBE1023	0.011/0.024
	Double	2	–	5	ZBE2033	0.020/0.044
		–	2	5	ZBE2043	0.020/0.044
		1	1	5	ZBE2053	0.020/0.044
	Single with body/fixing collar	1	–	1	ZB4BZ1013 (2)	0.053/0.117
		–	1	1	ZB4BZ1023 (2)	0.053/0.117
		2	–	1	ZB4BZ1033	0.062/0.137
		–	2	1	ZB4BZ1043	0.062/0.137
1		1	1	ZB4BZ1053	0.062/0.137	

Contacts for specific applications

Application	Type of contact	Description			Sold in lots of	Unit reference	Weight kg/lb
			NO	NC			
Low power switching	Single	Standard	1	–	5	ZBE10163 (2)	0.012/0.026
			–	1	5	ZBE10263 (2)	0.012/0.026
		Dusty environments (3) (IP 5X, 50 µm dust)	1	–	5	ZBE1016P3 (2)	0.012/0.026
			–	1	5	ZBE1026P3 (2)	0.012/0.026
Staggered contacts	Single	Early make	1	–	5	ZBE2013 (2)	0.011/0.024
		Late break	–	1	5	ZBE2023 (2)	0.011/0.024
		NC					
High power switching	Single	Standard (4)	1	–	1	ZBE5013	0.021/0.046
			–	1	1	ZBE5023	0.021/0.046
			2	–	1	ZBE5033	0.033/0.073
			–	2	1	ZBE5043	0.033/0.073
			1	1	1	ZBE5053	0.033/0.073

Clip-on legend holder for electrical blocks with screw clamp terminal connections (5)

For use with	Sold in lots of	Unit reference	Weight kg/lb
Identification of an XB4B control or signaling unit	10	ZBZ001	0.001/0.002
Sheet of 50 blank legends	10	ZBY001	0.023/0.051

- (1) The contact blocks enable variable composition of body/contact assemblies. Maximum number of rows possible: 3. Either 3 rows of 3 single contacts or 1 row of 3 double contacts + 1 row of 3 single contacts (double contacts occupy the first 2 rows).
- (2) To order products with screw clamp terminal connections for lugs, replace the 3 at the end of the reference with a 9. Example: ZBE1013 becomes ZBE1019.
- (3) It is not possible to fit an additional contact block on the back of these contact blocks.
- (4) It is not possible to use these contacts with light blocks.
- (5) This legend holder is not compatible with high power switching contact blocks.

To combine with heads, see page 26 to 73

101191



ZB4BZ009

101262



ZBE1014

101265



ZBE1024

101264



ZB4BZ1014

101266

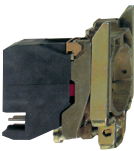

ZB4BZ1024

101270



ZBVB14

530719

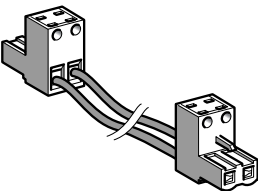

APE1C2250

Body/fixing collar

For use with	Sold in lots of	Unit reference	Weight kg/lb
Electrical block (contact or light)	10	ZB4BZ009	0.038/0.084

Contact functions

Plug-in connector (1)

Contacts for standard applications

Description	Type of contact	NO	NC	Sold in lots of	Unit reference	Weight kg/lb
Contact blocks	Single	1	–	5	ZBE1014	0.011/0.024
		–	1	5	ZBE1024	0.011/0.024
Contact blocks	Single with body/fixing collar	1	–	1	ZB4BZ1014	0.050/0.110
		–	1	1	ZB4BZ1024	0.050/0.110
		2	–	1	ZB4BZ1034	0.058/0.128
		–	2	1	ZB4BZ1044	0.058/0.128
		1	1	1	ZB4BZ1054	0.058/0.128
		1	2	1	ZB4BZ1414	0.064/0.141

Light blocks

Plug-in connector

Description	Supply voltage (V)	Color of light source	Sold in lots of	Unit reference	Weight kg/lb
Integral LED (to combine with heads for integral LED)	24 ~ (50/60 Hz)	White	5	ZBVB14	0.016/0.035
		Green	5	ZBVB34	0.016/0.035
		Red	5	ZBVB44	0.016/0.035
		Orange	5	ZBVB54	0.016/0.035
		Blue	5	ZBVB64	0.016/0.035
Protected LED	110...120 ~ (50/60 Hz)	White	5	ZBVG14	0.016/0.035
		Green	5	ZBVG34	0.016/0.035
		Red	5	ZBVG44	0.016/0.035
		Orange	5	ZBVG54	0.016/0.035
		Blue	5	ZBVG64	0.016/0.035
Protected LED	230...240 ~ (50/60 Hz)	White	5	ZBVM14	0.016/0.035
		Green	5	ZBVM34	0.016/0.035
		Red	5	ZBVM44	0.016/0.035
		Orange	5	ZBVM54	0.016/0.035
		Blue	5	ZBVM64	0.016/0.035

Connecting cables and connector

Description	Number of connectors	Wire c.s.a. mm ² /AWG	Length mm/in.	Sold in lots of	Unit reference	Weight kg/lb
Cables with connectors 2-pin, 5.08 mm/0.200 in. pitch	1	0.75/19	500/19.685	8	APE1C2150	0.120/0.265
	2	0.75/19	500/19.685	8	APE1C2250	0.180/0.397
Spring terminal connector 2-pin, 5.08 mm/0.200 in. pitch	–	0.2 to 0.5/25 to 14	–	10	APE1PRE21	0.003/0.007

(1) It is not possible to fit an additional contact block on the back of these contact blocks.

Control and signaling units

Harmony XB4, metal

Body/contact assemblies + light blocks with integral LED

To combine with:
Heads, see pages 31 to 59
Contacts, see page 76

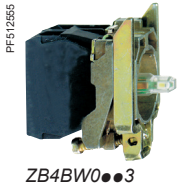

Complete body/contact assemblies and light blocks ⁽¹⁾						
Screw clamp terminal connections (Schneider Electric anti-loosening system)						
Light source	Supply voltage V	Type of contact		Color of light source	Reference	Weight kg/lb
		NO	NC			
Direct supply						
Integral LED Protected LED	24 ~ (50/60 Hz)	1	-	White	ZB4BW0B11	0.064/0.141
				Green	ZB4BW0B31	0.064/0.141
				Red	ZB4BW0B41	0.064/0.141
				Orange	ZB4BW0B51	0.064/0.141
				Blue	ZB4BW0B61	0.064/0.141
		-	1	White	ZB4BW0B12	0.064/0.141
				Green	ZB4BW0B32	0.064/0.141
				Red	ZB4BW0B42	0.064/0.141
				Orange	ZB4BW0B52	0.064/0.141
				Blue	ZB4BW0B62	0.064/0.141
	2	-	White	ZB4BW0B13	0.074/0.163	
			Green	ZB4BW0B33	0.074/0.163	
			Red	ZB4BW0B43	0.074/0.163	
			Orange	ZB4BW0B53	0.074/0.163	
			Blue	ZB4BW0B63	0.074/0.163	
	1	1	White	ZB4BW0B15	0.074/0.163	
			Green	ZB4BW0B35	0.074/0.163	
			Red	ZB4BW0B45	0.074/0.163	
			Orange	ZB4BW0B55	0.074/0.163	
			Blue	ZB4BW0B65	0.074/0.163	
110...120 ~ (50/60 Hz)	1	-	White	ZB4BW0G11	0.064/0.141	
			Green	ZB4BW0G31	0.064/0.141	
			Red	ZB4BW0G41	0.064/0.141	
			Orange	ZB4BW0G51	0.064/0.141	
			Blue	ZB4BW0G61	0.064/0.141	
	-	1	White	ZB4BW0G12	0.064/0.141	
			Green	ZB4BW0G32	0.064/0.141	
			Red	ZB4BW0G42	0.064/0.141	
			Orange	ZB4BW0G52	0.064/0.141	
			Blue	ZB4BW0G62	0.064/0.141	
2	-	White	ZB4BW0G13	0.074/0.163		
		Green	ZB4BW0G33	0.074/0.163		
		Red	ZB4BW0G43	0.074/0.163		
		Orange	ZB4BW0G53	0.074/0.163		
		Blue	ZB4BW0G63	0.074/0.163		
1	1	White	ZB4BW0G15	0.074/0.163		
		Green	ZB4BW0G35	0.074/0.163		
		Red	ZB4BW0G45	0.074/0.163		
		Orange	ZB4BW0G55	0.074/0.163		
		Blue	ZB4BW0G65	0.074/0.163		

Other versions Complete bodies with Faston connector terminals (6.35 or 2 x 2.8mm/0.250 or 2 x 0.110 in.)
Please contact our Customer Care Center.

(1) Can be fitted with additional contact blocks: see page 76.

To combine with:
 Heads, see pages 31 to 59
 Contacts, see page 76

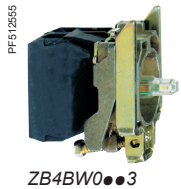

Complete body/contact assemblies and light blocks (continued) (1)								
Screw clamp terminal connections (Schneider Electric anti-loosening system)								
Light source	Supply voltage V	Type of contact		Color of light source	Reference	Weight kg/lb		
		NO	NC					
Direct supply (continued)								
Integral LED	230...240 ~ (50/60 Hz)	1	-	White	ZB4BW0M11	0.064/0.141		
				Green	ZB4BW0M31	0.064/0.141		
				Red	ZB4BW0M41	0.064/0.141		
				Orange	ZB4BW0M51	0.064/0.141		
				Blue	ZB4BW0M61	0.064/0.141		
				-	1	White	ZB4BW0M12	0.064/0.141
				Green		ZB4BW0M32	0.064/0.141	
				Red		ZB4BW0M42	0.064/0.141	
				Orange		ZB4BW0M52	0.064/0.141	
				Blue		ZB4BW0M62	0.064/0.141	
		2	-	White	ZB4BW0M13	0.074/0.163		
		Green		ZB4BW0M33	0.074/0.163			
		Red		ZB4BW0M43	0.074/0.163			
		Orange		ZB4BW0M53	0.074/0.163			
		Blue		ZB4BW0M63	0.074/0.163			
		1	1	White	ZB4BW0M15	0.074/0.163		
		Green		ZB4BW0M35	0.074/0.163			
		Red		ZB4BW0M45	0.074/0.163			
		Orange		ZB4BW0M55	0.074/0.163			
		Blue		ZB4BW0M65	0.074/0.163			

Other versions Complete bodies with Faston connector terminals (6.35 or 2 x 2.8mm/0.250 or 2 x 0.110 in.). Please contact our Customer Care Center.

(1) Can be fitted with additional contact blocks: see page 76.

Control and signaling units

Harmony XB4, metal

Body/light assemblies for pilot lights with integral LED

To combine with:
Heads, see page 66
Contacts, see page 76

101239



ZB4BV●●

Complete light bodies (fixing collar + light block with integral LED)				
Screw clamp terminal connections (Schneider Electric anti-loosening system)				
Light source	Supply voltage V	Color of light source	Reference	Weight kg/lb
Integral LED protected LED	12 ~ (50/60 Hz)	White	ZB4BVJ1	0.054/0.119
		Green	ZB4BVJ3	0.054/0.119
		Red	ZB4BVJ4	0.054/0.119
		Orange	ZB4BVJ5	0.054/0.119
		Blue	ZB4BVJ6	0.054/0.119
		24 ~ (1) (50/60 Hz)	White	ZB4BVB1
Green	ZB4BVB3		0.054/0.119	
Red	ZB4BVB4		0.054/0.119	
Orange	ZB4BVB5		0.054/0.119	
Blue	ZB4BVB6		0.054/0.119	
24...120 ~ (50/60 Hz)	White	ZB4BVBG1	0.054/0.119	
	Green	ZB4BVBG3	0.054/0.119	
	Red	ZB4BVBG4	0.054/0.119	
	Orange	ZB4BVBG5	0.054/0.119	
	Blue	ZB4BVBG6	0.054/0.119	
110...120 ~ (1) (50/60 Hz)	White	ZB4BVG1	0.054/0.119	
	Green	ZB4BVG3	0.054/0.119	
	Red	ZB4BVG4	0.054/0.119	
	Orange	ZB4BVG5	0.054/0.119	
	Blue	ZB4BVG6	0.054/0.119	
230...240 ~ (1) (50/60 Hz)	White	ZB4BVM1	0.054/0.119	
	Green	ZB4BVM3	0.054/0.119	
	Red	ZB4BVM4	0.054/0.119	
	Orange	ZB4BVM5	0.054/0.119	
	Blue	ZB4BVM6	0.054/0.119	

(1) Complete bodies with Faston connector terminals (6.35 or 2 x 2.8mm/0.250 or 2x 0.110 in.), see page 80.

To combine with:
Heads, see page 66
Contacts, see page 76

PF512556

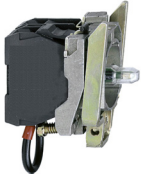

ZB4BVB●156

Complete light bodies with 3-terminal "test" function

(fixing collar + light block with integral LED + pre-wired block for "test light" function)

Screw clamp terminal connections (Schneider Electric anti-loosening system)

Light source	Supply voltage V	Color of light source	Reference	Weight kg/lb
Integral LED Protected LED	24 \sim (1) (50/60 Hz)	White	ZB4BVB1156	0.054/0.119
		Green	ZB4BVB3156	0.054/0.119
		Red	ZB4BVB4156	0.054/0.119
		Orange	ZB4BVB5156	0.054/0.119
		Blue	ZB4BVB6156	0.054/0.119

Complete bodies with flashing pilot light (fixing collar + light block with integral LED)

Screw clamp terminal connections (Schneider Electric anti-loosening system)

Light source	Supply voltage V	Color of light source	Reference	Weight kg/lb
Integral LED Protected LED	24 \sim (50/60 Hz)	White	ZB4BV18B1	0.054/0.119
		Green	ZB4BV18B3	0.054/0.119
		Red	ZB4BV18B4	0.054/0.119
		Orange	ZB4BV18B5	0.054/0.119
		Blue	ZB4BV18B6	0.054/0.119
		110...120 \sim (50/60 Hz)	White	ZB4BV18G1
	Green	ZB4BV18G3	0.054/0.119	
	Red	ZB4BV18G4	0.054/0.119	
	Orange	ZB4BV18G5	0.054/0.119	
	Blue	ZB4BV18G6	0.054/0.119	
	230...240 \sim (50/60 Hz)	White	ZB4BV18M1	0.054/0.119
		Green	ZB4BV18M3	0.054/0.119
		Red	ZB4BV18M4	0.054/0.119
		Orange	ZB4BV18M5	0.054/0.119
		Blue	ZB4BV18M6	0.054/0.119



(1) For a 120 or 230 V \sim supply, use complete body **ZB4BVG●** or **ZB4BVM●** with block for "test light" function type **ZBZM156**, see page 84 and 77.

Control and signaling units

Harmony XB4, metal

Body/contact assemblies + light blocks with BA 9s base fitting

To combine with:
Heads, see page 31
Contacts, see page 76

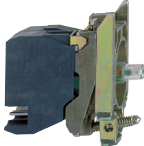
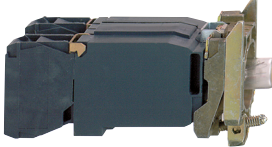
Complete body/contact assemblies and light blocks ⁽¹⁾							
For bulb with BA 9s base fitting (incandescent, neon or LED)							
Screw clamp terminal connections (Schneider Electric anti-loosening system)							
Light source	Supply voltage V	Type of contact		Color of light source	Reference	Weight kg/lb	
							
		NO	NC				
Direct supply							
 ZB4BW06●	BA9s base fitting bulb, 2.4 W max, not included ⁽²⁾	≤ 250	1	–	–	ZB4BW061	0.063/0.139
			–	1	–	ZB4BW062	0.063/0.139
			2	–	–	ZB4BW063	0.073/0.161
			1	1	–	ZB4BW065	0.073/0.161
Supply via integral transformer (1.2 VA, 6 V secondary)							
 ZB4BW05●	BA9s base fitting incandescent bulb, included	110...120 ~ 50/60 Hz	1	–	–	ZB4BW031	0.141/0.311
			1	1	–	ZB4BW035	0.151/0.333
		230 ~ 50 Hz	1	–	–	ZB4BW041	0.141/0.311
			1	1	–	ZB4BW045	0.151/0.333
		220...240 ~ 60 Hz	1	–	–	ZB4BW051	0.141/0.311
			1	1	–	ZB4BW055	0.151/0.333
	BA9s base fitting LED, included	110...120 ~ 50/60 Hz	1	1	White	ZB4BW03D15	0.151/0.333
					Green	ZB4BW03D35	0.151/0.333
					Red	ZB4BW03D45	0.151/0.333
					Orange	ZB4BW03D55	0.151/0.333
					Blue	ZB4BW03D65	0.151/0.333
		230 ~ 50 Hz	1	1	White	ZB4BW04D15	0.151/0.333
Green					ZB4BW04D35	0.151/0.333	
Red					ZB4BW04D45	0.151/0.333	
Orange					ZB4BW04D55	0.151/0.333	
Blue					ZB4BW04D65	0.151/0.333	
220...240 ~ 60 Hz		1	1	White	ZB4BW05D15	0.152/0.335	
				Green	ZB4BW05D35	0.152/0.335	
	Red			ZB4BW05D45	0.152/0.335		
	Orange			ZB4BW05D55	0.152/0.335		
	Blue			ZB4BW05D65	0.152/0.335		

Other versions Complete bodies with integral transformer incorporating Faston connector terminals (6.35 or 2 x 2.8 mm/0.250 or 2 x 0.110 in.). Please contact our Customer Care Center.

⁽¹⁾ Can be fitted with additional contact blocks: see page 76.
⁽²⁾ Bulb to be ordered separately: see page 108.

To combine with:
Heads, see page 67
Contacts, see page 76



ZB4BV6

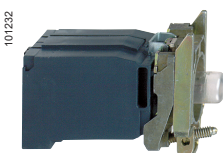

ZB4BV●



ZB4BV156

Light blocks

Screw clamp terminal connections (Schneider Electric anti-loosening system)

Description	Supply voltage V	Sold in lots of	Unit reference	Weight kg/lb
Direct supply for BA 9s base fitting bulb, 2.4 W max., not included (1)	≤ 250	5	ZBV6	0.016/0.035

Complete light bodies (fixing collar + light block)

For bulb with BA 9s base fitting (incandescent, neon or LED)

Screw clamp terminal connections (Schneider Electric anti-loosening system)

Light source	Supply voltage V	Color of light source	Reference	Weight kg/lb
Direct supply				
BA 9s base fitting bulb, 2.4 W max, not included (1)	≤ 250	–	ZB4BV6	0.052/0.335
Supply via integral transformer (1.2 VA, 6 V secondary)				
BA 9s base fitting incandescent bulb, included	110...120 ~ -50/60 Hz	–	ZB4BV3	0.130/0.287
	230 ~ - 50 Hz	–	ZB4BV4	0.130/0.287
	220...240 ~ - 60 Hz	–	ZB4BV5	0.131/0.289
	400 ~ - 50 Hz	–	ZB4BV8	0.128/0.282
	550...600 ~ - 60 Hz	–	ZB4BV9	0.131/0.289
BA 9s base fitting LED, included	110...120 ~ - 50/60 Hz	White	ZB4BV3D1	0.134/0.295
		Green	ZB4BV3D3	0.134/0.295
		Red	ZB4BV3D4	0.134/0.295
		Orange	ZB4BV3D5	0.134/0.295
		Blue	ZB4BV3D6	0.134/0.295
		–	–	–
	230 ~ - 50 Hz 220...240 ~ - 60 Hz	White	ZB4BV4D1	0.134/0.295
		Green	ZB4BV4D3	0.134/0.295
		Red	ZB4BV4D4	0.134/0.295
		Orange	ZB4BV4D5	0.134/0.295
		Blue	ZB4BV4D6	0.134/0.295
		–	–	–
400 ~ - 50/60 Hz	White	ZB4BV5D1	0.134/0.295	
	Green	ZB4BV5D3	0.134/0.295	
	Red	ZB4BV5D4	0.134/0.295	
	Orange	ZB4BV5D5	0.134/0.295	
	Blue	ZB4BV5D6	0.134/0.295	
	–	–	–	–

Complete light bodies with 3-terminal “test” function (fixing collar + light block)

For bulb with BA 9s base fitting (incandescent, neon or LED)

Screw clamp terminal connections (Schneider Electric anti-loosening system)

Direct supply

BA 9s base fitting bulb, 2.4 W max, not included (1)	≤ 250	–	ZB4BV156	0.062/0.137
--	-------	---	----------	-------------

Other versions Complete bodies with Faston connector terminals (6.35 or 2 x 2.8 mm/0.250 or 2 x 0.110 in.), see page 80.

(1) Bulb to be ordered separately, see page 108.

Control and signaling units

Harmony XB4 metal

Accessories for heads: caps



ZBA4



ZBL2



ZBA333

Pushbutton caps - unmarked

For use with	Type of push	Color	Sold in lots of	Unit reference	Weight kg/lb
ZBABA0 pushbutton heads supplied without cap	Flush	White	10	ZBA1	0.001/0.002
		Black	10	ZBA2	0.001/0.002
		Green	10	ZBA3	0.001/0.002
		Red	10	ZBA4	0.001/0.002
		Yellow	10	ZBA5	0.001/0.002
		Blue	10	ZBA6	0.001/0.002
	6 colors (1)	1	ZBA9	0.006/0.013	
	Projecting	White	10	ZBL1	0.001/0.002
		Black	10	ZBL2	0.001/0.002
		Green	10	ZBL3	0.001/0.002
		Red	10	ZBL4	0.001/0.002
		Yellow	10	ZBL5	0.001/0.002
		Blue	10	ZBL6	0.001/0.002
6 colors (1)	1	ZBL9	0.006/0.013		

Pushbutton caps - marked

For use with	Type of push	Marking		Color of cap	Unit reference	Weight kg/lb
		Text	Color			
ZBABA0 pushbutton heads supplied without cap (sold in lots of 10)	Flush	I (2)	White	Green	ZBA331	0.001/0.002
			Black	White	ZBA131	0.001/0.002
		II	White	Green	ZBA336	0.001/0.002
			Black	White	ZBA136	0.001/0.002
		III	White	Green	ZBA337	0.001/0.002
			Black	White	ZBA137	0.001/0.002
		IV	White	Green	ZBA338	0.001/0.002
			Black	White	ZBA138	0.001/0.002
		START (2)	White	Green	ZBA333	0.001/0.002
			Black	White	ZBA133	0.001/0.002
		ON	White	Green	ZBA341	0.001/0.002
			Black	White	ZBA141	0.001/0.002
		MARCHE	White	Green	ZBA342	0.001/0.002
			Black	White	ZBA142	0.001/0.002
		UP (2)	Black	White	ZBA343	0.001/0.002
		DOWN (2)	White	Black	ZBA344	0.001/0.002
		⊕ (2)	White	Black	ZBA245	0.001/0.002
			Black	White	ZBA145	0.001/0.002
		↑ (3)	White	Black	ZBA335	0.001/0.002
			Black	White	ZBA334	0.001/0.002
		O (2)	White	Red	ZBA432	0.001/0.002
				Black	ZBA232	0.001/0.002
		ARRET	White	Red	ZBA433	0.001/0.002
				Black	ZBA233	0.001/0.002
		STOP (2)	White	Red	ZBA434	0.001/0.002
				Black	ZBA234	0.001/0.002
		OFF	White	Red	ZBA435	0.001/0.002
				Black	ZBA235	0.001/0.002
		⬇	White	Green	ZBA346	0.001/0.002
		R (2)	White	Blue	ZBA639	0.001/0.002
		+	White	Black	ZBA2934	0.001/0.002
		-	White	Black	ZBA2935	0.001/0.002

(1) Set of 6 different colored caps: white, black, green, red, yellow, and blue.

(2) Double injection moulded marking.

(3) Can be clipped in at 90° steps, through 360°.

Control and signaling units

Harmony XB4, metal



Accessories for flush mounted heads

Pushbutton caps with markings

XB4_633_CP/MF51747



ZBAF331

Pushbutton caps, with markings for flush mounted heads						
For use with	Type of push	Marking		Color of cap	Unit reference	Weight kg/lb
		Text	Color			
Plastic pushbuttons						
ZB4FA0 and ZB5FA0 circular pushbutton heads supplied without cap (sold in lots of 10)	Flush	I (1)	White	Green	ZBAF331	0.001/0.002
			Black	White	ZBAF131	0.001/0.002
		II	White	Green	ZBAF336	0.001/0.002
			Black	White	ZBAF136	0.001/0.002
		III	White	Green	ZBAF337	0.001/0.002
			Black	White	ZBAF137	0.001/0.002
		IV	White	Green	ZBAF338	0.001/0.002
			Black	White	ZBAF138	0.001/0.002
		START (1)	White	Green	ZBAF333	0.001/0.002
			Black	White	ZBAF133	0.001/0.002
		ON	White	Green	ZBAF341	0.001/0.002
			Black	White	ZBAF141	0.001/0.002
		MARCHE	White	Green	ZBAF342	0.001/0.002
			Black	White	ZBAF142	0.001/0.002
		UP (1)	Black	White	ZBAF343	0.001/0.002
		DOWN (1)	White	Black	ZBAF344	0.001/0.002
		 (1)	White	Black	ZBAF245	0.001/0.002
			Black	White	ZBAF145	0.001/0.002
		↑ (2)	White	Black	ZBAF335	0.001/0.002
			Black	White	ZBAF334	0.001/0.002
		O (1)	White	Red	ZBAF432	0.001/0.002
			Black		ZBAF232	0.001/0.002
		ARRET	White	Red	ZBAF433	0.001/0.002
			Black		ZBAF233	0.001/0.002
		STOP (1)	White	Red	ZBAF434	0.001/0.002
			Black		ZBAF234	0.001/0.002
		OFF	White	Red	ZBAF435	0.001/0.002
			Black		ZBAF235	0.001/0.002
			White	Green	ZBAF346	0.001/0.002
		R (1)	White	Blue	ZBAF639	0.001/0.002
		+	White	Black	ZBAF2934	0.001/0.002
		-	White	Black	ZBAF2935	0.001/0.002

(1) Double injection moulded marking.

(2) Can be clipped in at 90° steps, through 360°

Control and signaling units

Harmony XB4 metal

Accessories for heads: boots, lens caps

107360



ZBP0

Transparent boots for pushbuttons (1)

Description	For use with XB4 metal pushbuttons	Sold in lots of	Unit reference	Weight kg/lb
Single boots (2)	Flush with circular head	10	ZBPA	0.002/0.004
	Projecting with circular head and push-push version	10	ZBP0	0.002/0.004
	Flush or projecting with circular head for food industry applications	10	ZBP0A	0.002/0.004

Colored boots

Description	Color	For use with	Sold in lots of	Unit reference	Weight kg/lb
Colored boots (can be replaced without dismantling the head)	White	ZB4BP1S	10	ZBP011	0.003/0.007
	Black	ZB4BP2S	10	ZBP012	0.003/0.007
	Green	ZB4BP3S	10	ZBP013	0.003/0.007
	Red	ZB4BP4S	10	ZBP014	0.003/0.007
	Yellow	ZB4BP5S	10	ZBP015	0.003/0.007
	Blue	ZB4BP6S	10	ZBP016	0.003/0.007
Clear membrane	Transparent	ZB4BP●83	10	ZBP017	0.003/0.007

(1) Boots for multiple-headed pushbuttons, see page 41.

(2) Permissible panel thickness 1 to 5 mm/0.039 to 0.197 in., cannot be used with legend holders.

PG113818



ZBV0153

PG113819

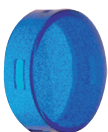

ZBV016

Lens caps				
For use with	Color	Sold in lots of	Unit reference	Weight kg/lb
Lens caps for light sources with integral LED				
Pilot lights	White	10	ZBV0113	0.002/0.004
	Green	10	ZBV0133	0.002/0.004
	Red	10	ZBV0143	0.002/0.004
	Orange	10	ZBV0153	0.002/0.004
	Blue	10	ZBV0163	0.002/0.004
	5 different colored grooved lenses (1)	10	ZBV0103S	0.010/0.022
Illuminated pushbuttons, with flush push	White	10	ZBW9113	0.002/0.004
	Green	10	ZBW9133	0.002/0.004
	Red	10	ZBW9143	0.002/0.004
	Orange	10	ZBW9153	0.002/0.004
	Blue	10	ZBW9163	0.002/0.004
Illuminated pushbuttons, with projecting push	White	10	ZBW9313	0.002/0.004
	Green	10	ZBW9333	0.002/0.004
	Red	10	ZBW9343	0.002/0.004
	Orange	10	ZBW9353	0.002/0.004
	Blue	10	ZBW9363	0.002/0.004
Lens caps for light sources with BA 9s base fitting				
Pilot lights	White	10	ZBV011	0.002/0.004
	Green	10	ZBV013	0.002/0.004
	Red	10	ZBV014	0.002/0.004
	Orange	10	ZBV015	0.002/0.004
	Blue	10	ZBV016	0.002/0.004
	Clear	10	ZBV017	0.002/0.004
Illuminated pushbuttons, with flush push	White	10	ZBW911	0.002/0.004
	Green	10	ZBW913	0.002/0.004
	Red	10	ZBW914	0.002/0.004
	Orange	10	ZBW915	0.002/0.004
	Blue	10	ZBW916	0.002/0.004
	Clear	10	ZBW917	0.002/0.004
Illuminated pushbuttons, with projecting push	White	10	ZBW931	0.002/0.004
	Green	10	ZBW933	0.002/0.004
	Red	10	ZBW934	0.002/0.004
	Orange	10	ZBW935	0.002/0.004
	Blue	10	ZBW936	0.002/0.004
	Clear	10	ZBW937	0.002/0.004

(1) Clear, green, red, orange, or blue.

Control and signaling units

Harmony XB4 metal

8 x 27 mm legends with 30 x 40 mm legend holders

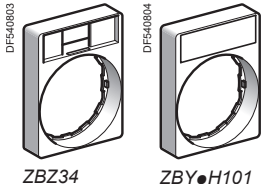

30 x 40 mm legend holders (flush mounting with bezel) for 8 x 27 mm legends (1)						
Description	Legend		Sold in lots of	Unit reference		Weight kg/lb
	Background color	Marking				
Without legend	–	–	10	ZBZ34	–	0.003/0.007
With blank legend	Black or red	–	10	ZBY2H101	–	0.004/0.009
	White or yellow	–	10	ZBY4H101	–	0.004/0.009



Standard 30 x 40 mm legend holders for 8 x 27 mm legends (1)								
Description	Legend		Sold in lots of	Unit reference		Weight kg/lb		
	Color	Marking		For black bezel	For gray bezel (4) (5)			
Without legend	–	–	10	ZBZ32	ZBZ32C0	0.001/0.002		
With blank legend (for engraving)	Black or red	–	10	ZBY2101	ZBY2101C0	0.002/0.004		
	White or yellow	–	10	ZBY4101	ZBY4101C0	0.002/0.004		
With 8 x 27 mm/ 0.315 x 1.063 in. legend (with international marking)	Black or red (2)	O (black background)	10	ZBY2146	–	0.002/0.004		
		O (red background)	10	ZBY2931	–	0.002/0.004		
		I	10	ZBY2147	–	0.002/0.004		
		II	10	ZBY2148	–	0.002/0.004		
		O-I	10	ZBY2178	ZBY2178C0	0.002/0.004		
		I-II	10	ZBY2179	–	0.002/0.004		
		I-O-II	10	ZBY2186	ZBY2186C0	0.002/0.004		
		AUTO	10	ZBY2115	–	0.002/0.004		
		STOP	10	ZBY2304	ZBY2304C0	0.002/0.004		
		Yellow	⚠	10	ZBY4140 (3)	–	0.002/0.004	
		With 8 x 27 mm/ 0.315 x 1.063 in. legend (with French language marking)	Black or red (2)	ARRET (red background)	10	ZBY2104	ZBY2104C0	0.002/0.004
				ARRET (black background)	10	ZBY0104	–	0.002/0.004
				ARRET GENERAL	10	ZBY2129	–	0.002/0.004
ARRET REARMEMENT	10			ZBY2133	–	0.002/0.004		
ARRET-MARCHE	10			ZBY2166	ZBY2166C0	0.002/0.004		
ARRIERE	10			ZBY2106	–	0.002/0.004		
AUTO CYCLE-CYCLE	10			ZBY2198	–	0.002/0.004		
AUTO CYCLE-MAIN	10			ZBY2199	–	0.002/0.004		
AUTO-MAIN	10			ZBY2164	–	0.002/0.004		
AUTO-O-MAIN	10			ZBY2185	–	0.002/0.004		
AVANT	10			ZBY2105	–	0.002/0.004		
AVANT-O-ARRIERE	10			ZBY2184	–	0.002/0.004		
C-P-C-NORMAL	10			ZBY2165	–	0.002/0.004		
CYCLE-MAIN	10			ZBY2197	–	0.002/0.004		
DECLenchement	10			ZBY2132	–	0.002/0.004		
DEFAULT (black background)	10			ZBY2134	–	0.002/0.004		
DEFAULT (red background)	10			ZBY2135	–	0.002/0.004		
DEPART CYCLE	10			ZBY2195	–	0.002/0.004		
DESCENTE	10			ZBY2108	–	0.002/0.004		
DROITE	10			ZBY2109	–	0.002/0.004		
ENCLenchement	10			ZBY2131	–	0.002/0.004		
EN SERVICE	10			ZBY2111	–	0.002/0.004		
FERMETURE	10			ZBY2114	–	0.002/0.004		
GAUCHE	10			ZBY2110	–	0.002/0.004		
HORS SERVICE	10			ZBY2112	–	0.002/0.004		
HORS-EN	10			ZBY2167	–	0.002/0.004		
LENT	10			ZBY2127	–	0.002/0.004		
MAIN	10	ZBY2116	–	0.002/0.004				
MARCHE	10	ZBY2103	ZBY2103C0	0.002/0.004				
MONTEE	10	ZBY2107	–	0.002/0.004				
Ouverture	10	ZBY2113	–	0.002/0.004				
PHASE/PHASE	10	ZBY2196	–	0.002/0.004				
REARMEMENT (red background)	10	ZBY2123	–	0.002/0.004				
REARMEMENT (black background)	10	ZBY0123	–	0.002/0.004				
SOUS TENSION	10	ZBY2126	–	0.002/0.004				
VITE	10	ZBY2128	–	0.002/0.004				
Red	ARRET D'URGENCE	10	ZBY2130 (3)	–	0.002/0.004			



(1) For legends, see pages 95 to 97.
 (2) "Start" functions: white letters on black background. "Stop" functions: white letters on red background (unless otherwise specified above).
 (3) For compliance with standard EN/ISO 13850, paragraph 4.4.6, the Emergency Stop function logo ⚠ has been added.
 (4) For white color plated bezel replace C0 with C1, and for other color plated bezels using the web customization tool, see page 5.
 (5) To add customized markings on these references using the web customization tool, see page 5.

Control and signaling units

Harmony XB4 metal

8 x 27 mm legends with 30 x 40 mm legend holders

Standard 30 x 40 mm legend holders with 8 x 27 mm legends (continued)						
Description	Legend		Sold in lots of	Reference		Weight kg/lb
	Color	Marking		For black bezel	For gray bezel (3) (4)	
With legend (with English language marking)	Black or red background (1)	AUTO-HAND	10	ZBY2364	–	0.002/0.004
		AUTO-O-HAND	10	ZBY2385	–	0.002/0.004
		CLOSE	10	ZBY2314	–	0.002/0.004
		DOWN	10	ZBY2308	–	0.002/0.004
		FAST	10	ZBY2328	–	0.002/0.004
		FORWARD	10	ZBY2305	–	0.002/0.004
		HAND	10	ZBY2316	–	0.002/0.004
		HAND-OFF-AUTO	10	ZBY2387	–	0.002/0.004
		INCH	10	ZBY2321	–	0.002/0.004
		LEFT	10	ZBY2310	–	0.002/0.004
		OFF	10	ZBY2312	–	0.002/0.004
		OFF-ON	10	ZBY2367	ZBY2367C0	0.002/0.004
		ON	10	ZBY2311	–	0.002/0.004
		OPEN	10	ZBY2313	–	0.002/0.004
		POWER ON	10	ZBY2326	–	0.002/0.004
		RESET (red background)	10	ZBY2323	–	0.002/0.004
		RESET (black background)	10	ZBY2322	–	0.002/0.004
		REVERSE	10	ZBY2306	–	0.002/0.004
		RIGHT	10	ZBY2309	–	0.002/0.004
		RUN	10	ZBY2334	–	0.002/0.004
		SLOW	10	ZBY2327	–	0.002/0.004
		START	10	ZBY2303	ZBY2303C0	0.002/0.004
		STOP-START	10	ZBY2366	–	0.002/0.004
UP	10	ZBY2307	–	0.002/0.004		
	Red background	EMERGENCY STOP	10	ZBY2330 (2)	–	0.002/0.004
With legend (with German language marking)	Black or red background (1)	AB	10	ZBY2208	–	0.002/0.004
		AUF	10	ZBY2207	–	0.002/0.004
		AUS	10	ZBY2204	–	0.002/0.004
		AUS-EIN	10	ZBY2266	–	0.002/0.004
		AUS-IN BETRIEB	10	ZBY2267	–	0.002/0.004
		AUS-RÜCKSTELLUNG	10	ZBY2233	–	0.002/0.004
		AUSSCHALTEN	10	ZBY2232	–	0.002/0.004
		AUTO-HAND	10	ZBY2364	–	0.002/0.004
		AUTO-O-HAND	10	ZBY2385	–	0.002/0.004
		AUTOZYKL-HAND	10	ZBY2299	–	0.002/0.004
		AUTOZYKL- 1 ZYKL	10	ZBY2298	–	0.002/0.004
		C-P-C-NORMAL	10	ZBY2265	–	0.002/0.004
		EIN	10	ZBY2203	–	0.002/0.004
		EINSCHALTEN	10	ZBY2231	–	0.002/0.004
		HAND	10	ZBY2316	–	0.002/0.004
		LANGSAM	10	ZBY2227	–	0.002/0.004
		LINKS	10	ZBY2210	–	0.002/0.004
		NOT-AUS (red background)	10	ZBY2230	–	0.002/0.004
		ÖFFNEN	10	ZBY2213	–	0.002/0.004
		RECHTS	10	ZBY2209	–	0.002/0.004
		RÜCKSTELLUNG	10	ZBY2223	–	0.002/0.004
		SCHLIESSEN	10	ZBY2214	–	0.002/0.004
		SCHNELL	10	ZBY2228	–	0.002/0.004
SPANNUNG EIN	10	ZBY2226	–	0.002/0.004		
STEUERUNG AUS	10	ZBY2212	–	0.002/0.004		
STEUERUNG EIN	10	ZBY2211	–	0.002/0.004		
STÖRUNG (black background)	10	ZBY2234	–	0.002/0.004		
STÖRUNG (red background)	10	ZBY2235	–	0.002/0.004		
VOR	10	ZBY2205	–	0.002/0.004		
VOR-O-ZURÜCK	10	ZBY2284	–	0.002/0.004		
ZURÜCK	10	ZBY2206	–	0.002/0.004		
ZYKLUS-HAND	10	ZBY2297	–	0.002/0.004		
ZYKLUSSTART	10	ZBY2295	–	0.002/0.004		
	Red background	NOT-HALT	10	ZBY2229 (2)	–	0.002/0.004
	Yellow background	NOT-HALT	10	ZBY22420001 (2)	–	0.002/0.004

XB5_CP19007



ZBY2303

XB5_CP19008



ZBY2228

(1) "Start" functions: white letters on black background. "Stop" functions: white letters on red background (unless otherwise specified above).

(2) For compliance with standard EN/ISO 13850, paragraph 4.4.6, the Emergency Stop function logo  has been added.

(3) For white color plated bezel replace C0 with C1, and for other color plated bezels using the web customization tool, see page 5.

(4) To add customized markings on these references using the web customization tool, see page 5.

XB5_CP19019



ZBYP2101

XB5_CP19023



ZBYM2303

Standard 30 x 40 mm legend plates

Description	Marking (3)	Sold in lots of	Unit Reference		Weight kg/lb
			For black bezel	For gray bezel (1) (2)	
Legend plate, plastic	-	10	ZBYP2101	ZBYP2101C0	0.001/0.002
	O-I	10	ZBYP2178	ZBYP2178C0	0.001/0.002
	STOP	10	ZBYP2304	ZBYP2304C0	0.001/0.002
	START	10	ZBYP2303	ZBYP2303C0	0.001/0.002
	MARCHE	10	ZBYP2103	ZBYP2103C0	0.001/0.002
	I-O-II	10	ZBYP2186	ZBYP2186C0	0.001/0.002
	OFF-ON	10	ZBYP2367	ZBYP2367C0	0.001/0.002
	ARRET-MARCHE	10	ZBYP2166	ZBYP2166C0	0.001/0.002
	ARRET	10	ZBYP2104	ZBYP2104C0	0.001/0.002
Legend plate, metal	-	10	ZBYM2101	-	0.004/0.009
	O-I	10	ZBYM2178	-	0.004/0.009
	STOP	10	ZBYM2304	-	0.004/0.009
	START	10	ZBYM2303	-	0.004/0.009
	MARCHE	10	ZBYM2103	-	0.004/0.009
	I-O-II	10	ZBYM2186	-	0.004/0.009
	OFF-ON	10	ZBYM2367	-	0.004/0.009
	ARRET-MARCHE	10	ZBYM2166	-	0.004/0.009
	ARRET	10	ZBYM2104	-	0.004/0.009

(1) For white color plated bezel replace C0 by C1, and for other color plated bezel through web customization tool, see page 5.

(2) To add customized markings on these references through web customization tool, see page 5.

(3) Black marking for metal references, white marking for standard references.

8 x 27 mm marked legends for 30 x 40 mm legend holders ZBZ32 and ZBZ34							
Language	Background color	Marking	Sold in lots of	Reference	Weight kg/lb		
Without	Black or red	–	10	ZBY0101 (3)	0.001/0.002		
	White or yellow	–	10	ZBY0102 (3)	0.001/0.002		
International	Black or red (1)	O (black background)	10	ZBY02146	0.001/0.002		
		O (red background)	10	ZBY02931	0.001/0.002		
		I	10	ZBY02147	0.001/0.002		
		II	10	ZBY02148	0.001/0.002		
		O-I	10	ZBY02178	0.001/0.002		
		I-II	10	ZBY02179	0.001/0.002		
		I-O-II	10	ZBY02186	0.001/0.002		
		AUTO	10	ZBY02115	0.001/0.002		
		STOP	10	ZBY02304	0.001/0.002		
		Yellow		10	ZBY0140 (2)	0.001/0.002	
		French	Black or red (1)	ARRET (red background)	10	ZBY02104	0.001/0.002
				ARRET (black background)	10	ZBY00104	0.001/0.002
	ARRET GENERAL			10	ZBY02129	0.001/0.002	
ARRET REARMEMENT	10			ZBY02133	0.001/0.002		
ARRET-MARCHE	10			ZBY02166	0.001/0.002		
ARRIERE	10			ZBY02106	0.001/0.002		
AUTO CYCLE-CYCLE	10			ZBY02198	0.001/0.002		
AUTO CYCLE-MAIN	10			ZBY02199	0.001/0.002		
AUTO-MAIN	10			ZBY02164	0.001/0.002		
AUTO-O-MAIN	10			ZBY02185	0.001/0.002		
AVANT	10			ZBY02105	0.001/0.002		
AVANT-O-ARRIERE	10			ZBY02184	0.001/0.002		
C-P-C-NORMAL	10			ZBY02165	0.001/0.002		
CYCLE-MAIN	10			ZBY02197	0.001/0.002		
DECLENCHEMENT	10			ZBY02132	0.001/0.002		
DEFAUT (black background)	10			ZBY02134	0.001/0.002		
DEFAUT (red background)	10			ZBY02135	0.001/0.002		
DEPART CYCLE	10			ZBY02195	0.001/0.002		
DESCENTE	10			ZBY02108	0.001/0.002		
DROITE	10			ZBY02109	0.001/0.002		
ENCLENCHEMENT	10			ZBY02131	0.001/0.002		
EN SERVICE	10			ZBY02111	0.001/0.002		
FERMETURE	10			ZBY02114	0.001/0.002		
GAUCHE	10			ZBY02110	0.001/0.002		
HORS SERVICE	10			ZBY02112	0.001/0.002		
HORS-EN	10			ZBY02167	0.001/0.002		
LENT	10			ZBY02127	0.001/0.002		
MAIN	10			ZBY02116	0.001/0.002		
MARCHE	10			ZBY02103	0.001/0.002		
MONTEE	10			ZBY02107	0.001/0.002		
OUVERTURE	10			ZBY02113	0.001/0.002		
PHASE/PHASE	10			ZBY02196	0.001/0.002		
REARMEMENT (red background)	10			ZBY02123	0.001/0.002		
REARMEMENT (black background)	10	ZBY00123	0.001/0.002				
SOUS TENSION	10	ZBY02126	0.001/0.002				
VITE	10	ZBY02128	0.001/0.002				
Red	ARRET D'URGENCE	10	ZBY02130 (2)	0.001/0.002			

(1) "Start" functions: white letters on black background. "Stop" functions: white letters on red background (unless otherwise specified above)

(2) For compliance with standard EN/ISO 13850, paragraph 4.4.6, the Emergency Stop function logo  has been added.

(3) To add customized markings on these references using the web customization tool, see page 5.

DG121137



ZBY02931

DFE40629



ZBY0140

DG121117



ZBY02104

Control and signaling units

Harmony XB4 metal

Legends 8 x 27 mm

DG121279

START

ZBY02303

8 x 27 mm marked legends (for 30 x 40 mm legend holders ZBZ32 and ZBZ34) (3)
(continued)

Language	Background color	Marking	Sold in lots of	Unit reference	Weight kg/lb		
English	Black or red (1)	AUTO-HAND	10	ZBY02364	0.001/0.002		
		AUTO-O-HAND	10	ZBY02385	0.001/0.002		
		CLOSE	10	ZBY02314	0.001/0.002		
		DOWN	10	ZBY02308	0.001/0.002		
		FAST	10	ZBY02328	0.001/0.002		
		FORWARD	10	ZBY02305	0.001/0.002		
		HAND	10	ZBY02316	0.001/0.002		
		HAND-OFF-AUTO	10	ZBY02387	0.001/0.002		
		INCH	10	ZBY02321	0.001/0.002		
		LEFT	10	ZBY02310	0.001/0.002		
		OFF	10	ZBY02312	0.001/0.002		
		OFF-ON	10	ZBY02367	0.001/0.002		
		ON	10	ZBY02311	0.001/0.002		
		OPEN	10	ZBY02313	0.001/0.002		
		POWER ON	10	ZBY02326	0.001/0.002		
		RESET (red background)	10	ZBY02323	0.001/0.002		
		RESET (black background)	10	ZBY02322	0.001/0.002		
		REVERSE	10	ZBY02306	0.001/0.002		
		RIGHT	10	ZBY02309	0.001/0.002		
		RUN	10	ZBY02334	0.001/0.002		
		SLOW	10	ZBY02327	0.001/0.002		
		START	10	ZBY02303	0.001/0.002		
		STOP-START	10	ZBY02366	0.001/0.002		
		UP	10	ZBY02307	0.001/0.002		
		Red		EMERGENCY STOP	10	ZBY02330 (2)	0.001/0.002

(1) "Start" functions: white letters on black background. "Stop" functions: white letters on red background (unless otherwise specified above).

(2) For compliance with standard EN/ISO 13850, paragraph 4.4.6, the Emergency Stop function logo  has been added.

(3) To add customized markings on these references using the web customization tool, see page 5.

DG121264

SCHNELL

ZBY02228

8 x 27 mm marked legends (for 30 x 40 mm legend holders ZBZ32 and ZBZ34) (continued) (3)					
Language	Background color	Marking	Sold in lots of	Unit reference	Weight kg/lb
German	Black or red (1)	AB	10	ZBY02208	0.001/0.002
		AUF	10	ZBY02207	0.001/0.002
		AUS	10	ZBY02204	0.001/0.002
		AUS-EIN	10	ZBY02266	0.001/0.002
		AUS-IN BETRIEB	10	ZBY02267	0.001/0.002
		AUS-RÜCKSTELLUNG	10	ZBY02233	0.001/0.002
		AUSSCHALTEN	10	ZBY02232	0.001/0.002
		AUTO-HAND	10	ZBY02364	0.001/0.002
		AUTO-O-HAND	10	ZBY02385	0.001/0.002
		AUTOZYKL-HAND	10	ZBY02299	0.001/0.002
		AUTOZYKL- 1 ZYKL	10	ZBY02298	0.001/0.002
		C-P-C-NORMAL	10	ZBY02265	0.001/0.002
		EIN	10	ZBY02203	0.001/0.002
		EINSCHALTEN	10	ZBY02231	0.001/0.002
		HAND	10	ZBY02316	0.001/0.002
		LANGSAM	10	ZBY02227	0.001/0.002
		LINKS	10	ZBY02210	0.001/0.002
		NOT-AUS (red background)	10	ZBY02230	0.001/0.002
		ÖFFNEN	10	ZBY02213	0.001/0.002
		RECHTS	10	ZBY02209	0.001/0.002
		RÜCKSTELLUNG	10	ZBY02223	0.001/0.002
		SCHLIESSEN	10	ZBY02214	0.001/0.002
		SCHNELL	10	ZBY02228	0.001/0.002
		SPANNUNG EIN	10	ZBY02226	0.001/0.002
		STEUERUNG AUS	10	ZBY02212	0.001/0.002
		STEUERUNG EIN	10	ZBY02211	0.001/0.002
		STÖRUNG (black background)	10	ZBY02234	0.001/0.002
		STÖRUNG (red background)	10	ZBY02235	0.001/0.002
		VOR	10	ZBY02205	0.001/0.002
		VOR-O-ZURÜCK	10	ZBY02284	0.001/0.002
		ZURÜCK	10	ZBY02206	0.001/0.002
		ZYKLUS-HAND	10	ZBY02297	0.001/0.002
ZYKLUSSTART	10	ZBY02295	0.001/0.002		
Red		NOT-HALT	10	ZBY02229 (2)	0.001/0.002
Yellow		NOT-HALT	10	ZBY022420001 (2)	0.001/0.002

814309

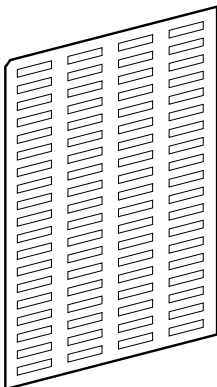

ZBY4100

Sheets of peel-off legends (with backing board and protective transparent cover)

Description	For use with	Sold in lots of	Unit reference	Weight kg/lb
Sheet of 76 legends Ø 8 x 27 mm/ 0.315 x 1.063 in.	Ø 30 x 40 mm/1.181 x 1.575 in. legend holder ZBZ32 and ZBZ34	10	ZBY4100	0.043/0.095

(1) "Start" functions: white letters on black background. "Stop" functions: white letters on red background (unless otherwise specified above).

(2) For compliance with standard EN/ISO 13850, paragraph 4.4.6, the Emergency Stop function logo (⊘) has been added.

(3) To add customized markings on these references using the web customization tool, see page 5.

Control and signaling units

Harmony XB4 metal

Legend holders for 18 x 27 mm legends

18 x 27 mm legends for engraving

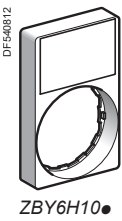
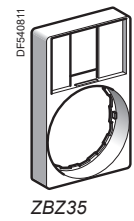
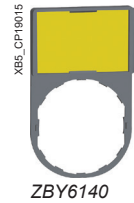
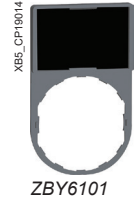

Standard 30 x 50 mm legend holders for 18 x 27 mm legends (2)					
Description	Background color	Sold in lots of	Unit reference		Weight kg/lb
			For black bezel	For gray bezel (3)	
Without legend	–	10	ZBZ33	ZBZ33C0	0.001/0.002
With blank legend	Black or red	10	ZBY6101	ZBY6101C0	0.002/0.004
	White or yellow	10	ZBY6102	ZBY6102C0	0.002/0.004
	Yellow	10	ZBY6140 (1)	–	0.002/0.004

30 x 50 mm legend holder (flush mounting with bezel) for 18 x 27 mm legends					
Description	Background color	Sold in lots of	Unit reference		Weight kg/lb
			For black bezel	For gray bezel (3)	
Without legend	–	10	ZBZ35	–	0.003/0.007
With blank legend	Black or red	10	ZBY6H101	–	0.004/0.009
	White or yellow	10	ZBY6H102	–	0.004/0.009

30 x 50 mm legend plates					
Description	Sold in lots of	Unit reference		Weight kg/lb	
		For black bezel	For gray bezel (3)		
Legend plate, plastic	10	ZBYP6101	ZBYP6101C0	0.001/0.002	
Legend plate, metal	10	ZBYM6101	–	0.006/0.013	

18 x 27 mm legends for engraving for 30 x 50 mm legend holders (2)						
Description	Language	Marking	Sold in lots of	Unit reference		Weight kg/lb
				For black bezel	For gray bezel (3)	
Black or red background	–	Without	10	ZBY5101	–	0.001/0.002
White or yellow background	–	Without	10	ZBY5102	–	0.001/0.002
Yellow background	International		10	ZBY5140 (1)	–	0.001/0.002
	French	ARRET D'URGENCE	10	ZBY55130 (1)	–	0.001/0.002
	English	EMERGENCY STOP	10	ZBY55330 (1)	–	0.001/0.002

18 x 27 mm legends for engraving for 30 x 50 mm legend holders					
Description	For use with	Sold in lots of	Unit reference		Weight kg/lb
			For black bezel	For gray bezel (3)	
Sheet of 40 18 x 27 mm/ 0.709 x 1.063 in. legends	30 x 50 mm/ 1.181 x 1.968 in. legend holder ZBZ33 and ZBZ35	10	ZBY5100	–	0.044/0.097

(1) For compliance with standard EN/ISO 13850, paragraph 4.4.6, the Emergency Stop function logo has been added.

(2) For white color plated bezel replace C0 with C1, and for other color plated bezels using the web customization tool, see page 5.

(3) To add customized markings on these references using the web customization tool, see page 5.

Control and signaling units

Harmony XB4 metal

Legend holders for flush mounted heads

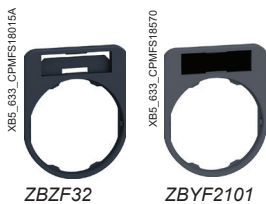

Standard 40 x 50 mm legend holders for 8 x 27 mm legends - for flush mounted heads						
Description	Color	Sold in lots of	Unit reference		Weight kg/lb	
			For black bezel	For gray bezel (2)(3)		
Without legend	–	10	ZBZF32	–	0.001/0.002	
With blank legend (for engraving)	Black or red	10	ZBYF2101	ZBYF2101C0	0.002/0.004	
	White or yellow	10	ZBYF4101	ZBYF4101C0	0.002/0.004	
With 8 x 27 mm/ 0.315 x 1.063 in. legend (with international marking)	Black or red (1)	O-I	10	ZBYF2178	ZBYF2178C0	0.003/0.007
		STOP	10	ZBYF2304	ZBYF2304C0	0.003/0.007
		START (in white)	10	ZBYF2303	ZBYF2303C0	0.003/0.007
		MARCHE	10	ZBYF2103	ZBYF2103C0	0.003/0.007
		I-O-II	10	ZBYF2186	ZBYF2186C0	0.003/0.007
		OFF-ON	10	ZBYF2367	ZBYF2367C0	0.003/0.007
		ARRET-MARCHE	10	ZBYF2166	ZBYF2166C0	0.003/0.007

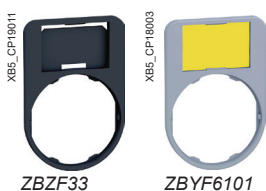

Standard 40 x 60 mm legend holders for 18 x 27 mm legends - for flush mounted heads					
Description	Color	Sold in lots of	Unit reference		Weight kg/lb
			For black bezel	For gray bezel (2)(3)	
Without legend	–	10	ZBZF33	–	0.001/0.002
With blank legend (for engraving)	Black or red	10	ZBYF6101	ZBYF6101C0	0.002/0.004
	White or yellow	10	ZBYF6102	ZBYF6102C0	0.002/0.004



Standard 40 x 50 mm legend plate - for flush mounted heads						
Description	Color	Marking	Sold in lots of	Unit reference		Weight kg/lb
				For black bezel	For gray bezel (2)(3)	
Legend plate, plastic	–	–	10	ZBYFP2101	ZBYFP2101C0	0.003/0.007
		O-I	10	ZBYFP2178	ZBYFP2178C0	0.003/0.007
		STOP	10	ZBYFP2304	ZBYFP2304C0	0.003/0.007
		START	10	ZBYFP2303	ZBYFP2303C0	0.003/0.007
		MARCHE	10	ZBYFP2103	ZBYFP2103C0	0.003/0.007
		I-O-II	10	ZBYFP2186	ZBYFP2186C0	0.003/0.007
		OFF-ON	10	ZBYFP2367	ZBYFP2367C0	0.003/0.007
		ARRET-MARCHE	10	ZBYFP2166	ZBYFP2166C0	0.003/0.007
		ARRET	10	ZBYFP2104	ZBYFP2104C0	0.003/0.007

40 x 60 mm legend plate - for flush mounted heads						
Description	Color	Marking	Sold in lots of	Unit Reference		Weight kg/lb
				For black bezel	For gray bezel (2)(3)	
Legend plate, plastic	–	–	10	ZBYFP6101	ZBYFP6101C0	0.003/0.007

(1) Black marking for metal references, white marking for standard references.

(2) For white color plated bezel replace C0 with C1, and for other color plated bezels using the web customization tool, see page 5.

(3) To add customized markings on these references using the web customization tool, see page 5.

Control and signaling units

Harmony XB4 metal

Legends for insertion, printing, or pre-printed, circular
Bellows for harsh environments

DF540813

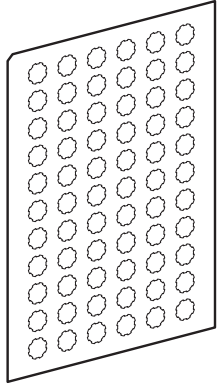

ZBY1101

Legends for XB5A pushbuttons, illuminated pushbuttons, and pilot lights (2)					
Description	Language	Marking	Sold in lots of	Unit reference	Weight kg/lb
Sheets of 66 circular peel-off, transparent, self-adhesive legends	–	Without	10	ZBY1101	0.017/0.037
Strips of 66 circular peel-off, transparent, self-adhesive legends	International	O	10	ZBY1146	0.017/0.037
		I	10	ZBY1147	0.017/0.037
		II	10	ZBY1148	0.017/0.037
		III	10	ZBY1149	0.017/0.037
		STOP	10	ZBY1304	0.017/0.037
		↑	10	ZBY1912	0.017/0.037
	French	ARRET	10	ZBY1104	0.017/0.037
		ARRIERE	10	ZBY1106	0.017/0.037
		AUTO	10	ZBY1115	0.017/0.037
		AVANT	10	ZBY1105	0.017/0.037
DESCENTE		10	ZBY1108	0.017/0.037	
MAIN		10	ZBY1116	0.017/0.037	
MARCHE		10	ZBY1103	0.017/0.037	
MONTEE		10	ZBY1107	0.017/0.037	
English	HAND	10	ZBY1316	0.017/0.037	
	OFF	10	ZBY1312	0.017/0.037	
	ON	10	ZBY1311	0.017/0.037	
	START	10	ZBY1303	0.017/0.037	
German	AB	10	ZBY1208	0.017/0.037	
	AUF	10	ZBY1207	0.017/0.037	
	AUS	10	ZBY1204	0.017/0.037	
	EIN	10	ZBY1203	0.017/0.037	
	ZU	10	ZBY1214	0.017/0.037	

107361



ZBZ48

Bellows for harsh environments					
Description	Material	Color	Sold in lots of	Reference	Weight kg/lb
Environments subject to humidity, dust, high-pressure cleaning, etc.	Silicone	Red	2	ZBZ48	0.009/0.020

(1) To add customized markings on these references using the web customization tool, see page 5.

Control and signaling units

Harmony XB4 metal

Illuminated rings and circular yellow legends for mushroom head pushbuttons

Illuminated rings for mushroom head pushbuttons (1)

Description	Marking	Signaling	Supply voltage	Color	Sold in lots of	Reference	Weight kg/lb
Ø 60 mm/2.362 in. illuminated ring	-	Fixed, red	24 V ~	Yellow	1	ZBY9W2B101	0.031/0.068
	-	Fixed, red	120 V ~	Yellow	1	ZBY9W2G101	0.031/0.068
	-	Fixed, red	230 V ~	Yellow	1	ZBY9W2M101	0.031/0.068
	-	Fixed, red + white	24 V ~	Yellow	1	ZBY9W3B101	0.031/0.068

Circular yellow legends for mushroom head pushbuttons

Used for "Emergency stop" function (1)

Diameter mm/in.	Conforming to standards	Marking on yellow background	Sold in lots of	Reference	Weight kg/lb
60/2.363	EN/IEC 60204-1	-	5	ZBY9121	0.007/0.015
		EMERGENCY STOP	5	ZBY9320	0.007/0.015
		ARRET D'URGENCE	5	ZBY9120	0.007/0.015
		NOT-HALT	5	ZBY9220	0.007/0.015
		PARADA DE EMERGENCIA	5	ZBY9420	0.007/0.015
		ARRESTO DI EMERGENZA	5	ZBY9620	0.007/0.015
90/3.543	EN/IEC 60204-1 and EN/ISO 13850	-	10	ZBY8140	0.008/0.018
		ARRET D'URGENCE	10	ZBY8130	0.008/0.018
		EMERGENCY STOP	10	ZBY8330	0.008/0.018
		NOT-HALT	10	ZBY8230	0.008/0.018
		PARADA DE EMERGENCIA	10	ZBY8430	0.008/0.018
		ARRESTO DE EMERGENZA	10	ZBY8630	0.008/0.018

Used for "Emergency switching off" function

60/2.362	EN/IEC 60204-1	-	10	ZBY9101	0.004/0.009
		COUPURE D'URGENCE	10	ZBY9160	0.004/0.009
		EMERGENCY SWITCHING OFF	10	ZBY9360	0.004/0.009
		NOT-AUS	10	ZBY9260	0.004/0.009
		DESCONEXION DE EMERGENCIA	10	ZBY9460	0.004/0.009
		INTERRUZIONE DI EMERGENZA	10	ZBY9660	0.004/0.009
90/3.543	EN/IEC 60204-1	-	10	ZBY8101	0.008/0.018
		COUPURE D'URGENCE	10	ZBY8160	0.008/0.018
		EMERGENCY SWITCHING OFF	10	ZBY8360	0.008/0.018
		NOT-AUS	10	ZBY8260	0.008/0.018
		DESCONEXION DE EMERGENCIA	10	ZBY8460	0.008/0.018
		INTERRUZIONE DI EMERGENZA	10	ZBY8660	0.008/0.018

(1) For compliance with standard EN/ISO 13850, paragraph 4.4.6, the Emergency Stop function logo  has been added.

PF131020



ZBY9320

XB4_032_CPF_UR10301



ZBY9360

Control and signaling units

Harmony XB4 metal

Legends panel

XB4_632_CPS/VA18028

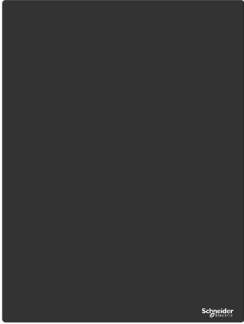

ZBYLEG304000

ZBYLEG201001

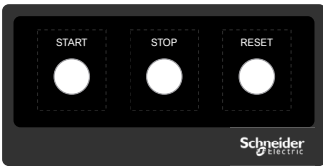

ZBYLEG201001

XB4_632_CPS/VA18028



ZBYLEG304001

XB4_632_CPS/VA18028



ZBYLEG503001

Legends panel (1)

Template size mm/in.	Unit reference	Weight kg/lb
Unmarked templates		
100 x 100/3.93 x 3.93	ZBYLEG101000	0.010/0.022
200 x 100/7.87 x 3.93	ZBYLEG201000	0.010/0.022
300 x 100/11.81 x 3.93	ZBYLEG301000	0.010/0.022
300 x 200/11.81 x 7.87	ZBYLEG302000	0.030/0.066
300 x 300/11.81 x 11.81	ZBYLEG303000	0.030/0.066
300 x 400/11.81 x 15.74	ZBYLEG304000	0.030/0.066
400 x 100/15.74 x 3.93	ZBYLEG401000	0.010/0.022
400 x 200/15.74 x 7.87	ZBYLEG402000	0.050/0.110
500 x 100/19.68 x 3.93	ZBYLEG501000	0.030/0.066
500 x 200/19.68 x 7.87	ZBYLEG502000	0.050/0.110
500 x 300/19.68 x 11.81	ZBYLEG503000	0.050/0.110
500 x 400/19.68 x 15.74	ZBYLEG504000	0.050/0.110
Marked templates		
100 x 100/3.93 x 3.93	ZBYLEG101001	0.010/0.022
200 x 100/7.87 x 3.93	ZBYLEG201001	0.010/0.022
300 x 100/11.81 x 3.93	ZBYLEG301001	0.010/0.022
300 x 200/11.81 x 7.87	ZBYLEG302001	0.030/0.066
300 x 300/11.81 x 11.81	ZBYLEG303001	0.030/0.066
300 x 400/11.81 x 15.74	ZBYLEG304001	0.030/0.066
400 x 100/15.74 x 3.93	ZBYLEG401001	0.010/0.022
400 x 200/15.74 x 7.87	ZBYLEG402001	0.050/0.110
500 x 100/19.68 x 3.93	ZBYLEG501001	0.030/0.066
500 x 200/19.68 x 7.87	ZBYLEG502001	0.050/0.110
500 x 300/19.68 x 11.81	ZBYLEG503001	0.050/0.110
500 x 400/19.68 x 15.74	ZBYLEG504001	0.050/0.110

(1) To add customized markings on these references using the web customization tool, see page 5

Control and signaling units

Harmony XB4 metal

Illuminated rings for Emergency stop

XB4_632_CPS(VA)18028



ZBY9W2B330

Illuminated rings for Emergency stop (1)							
Description	Marking	Signaling	Supply voltage	Color	Sold in lots of	Reference	Weight kg/lb
Ø 60 mm/2.362 in. illuminated ring for Emergency stop	EMERGENCY STOP	Fixed, red	24 V ~	Yellow	1	ZBY9W2B330	0.031/0.068
	ARRET D'URGENCE	Fixed, red	24 V ~	Yellow	1	ZBY9W2B130	0.031/0.068
	NOT HALT	Fixed, red	24 V ~	Yellow	1	ZBY9W2B230	0.031/0.068
	PARADA DE EMERGENCIA	Fixed, red	24 V ~	Yellow	1	ZBY9W2B430	0.031/0.068
	ARRESTO DI EMERGENZA	Fixed, red	24 V ~	Yellow	1	ZBY9W2B630	0.031/0.068
	-	Fixed, red	24 V ~	Yellow	1	ZBY9W2B140	0.031/0.068
	EMERGENCY STOP	Fixed, red	120 V ~	Yellow	1	ZBY9W2G330	0.031/0.068
	ARRET D'URGENCE	Fixed, red	120 V ~	Yellow	1	ZBY9W2G130	0.031/0.068
	NOT HALT	Fixed, red	120 V ~	Yellow	1	ZBY9W2G230	0.031/0.068
	PARADA DE EMERGENCIA	Fixed, red	120 V ~	Yellow	1	ZBY9W2G430	0.031/0.068
	ARRESTO DI EMERGENZA	Fixed, red	120 V ~	Yellow	1	ZBY9W2G630	0.031/0.068
	-	Fixed, red	120 V ~	Yellow	1	ZBY9W2G140	0.031/0.068
	EMERGENCY STOP	Fixed, red	230 V ~	Yellow	1	ZBY9W2M330	0.031/0.068
	ARRET D'URGENCE	Fixed, red	230 V ~	Yellow	1	ZBY9W2M130	0.031/0.068
	NOT HALT	Fixed, red	230 V ~	Yellow	1	ZBY9W2M230	0.031/0.068
	PARADA DE EMERGENCIA	Fixed, red	230 V ~	Yellow	1	ZBY9W2M430	0.031/0.068
	ARRESTO DI EMERGENZA	Fixed, red	230 V ~	Yellow	1	ZBY9W2M630	0.031/0.068
	-	Fixed, red	230 V ~	Yellow	1	ZBY9W2M140	0.031/0.068
	EMERGENCY STOP	Fixed, red + white	24 V ~	Yellow	1	ZBY9W3B330	0.031/0.068
ARRET D'URGENCE	Fixed, red + white	24 V ~	Yellow	1	ZBY9W3B130	0.031/0.068	
NOT HALT	Fixed, red + white	24 V ~	Yellow	1	ZBY9W3B230	0.031/0.068	
PARADA DE EMERGENCIA	Fixed, red + white	24 V ~	Yellow	1	ZBY9W3B430	0.031/0.068	
ARRESTO DI EMERGENZA	Fixed, red + white	24 V ~	Yellow	1	ZBY9W3B630	0.031/0.068	
-	Fixed, red + white	24 V ~	Yellow	1	ZBY9W3B140	0.031/0.068	

XB4_632_CPS(VA)18028



ZBY9W3B140

(1) For compliance with standard EN/ISO 13850, paragraph 4.4.6, the Emergency Stop function logo  has been added.

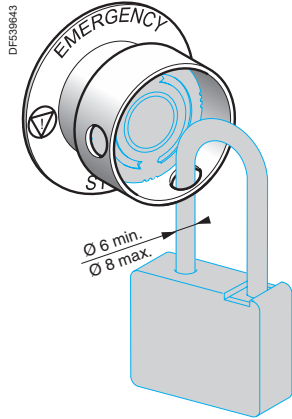

ZBZ3605



ZBY9330T



ZBY9360T

Accessories for mushroom head pushbuttons

Description	Exclusive use with the following Ø 40 mm/1.575 in. trigger action pushbuttons	Color	Reference	Weight kg/lb
Padlocking kit (1) (2) For Emergency stop (3) and Emergency switching off function (4), (padlockable)	XB4BS844●, XB4BS9445, ZB4BS844, ZB4BS944●.	Yellow	ZBZ3605	0.045/0.099

Description	Marking	Color	Sold in lots of	Reference	Weight kg/lb
Ø 60 mm/2.362 in. legend for padlocking device ZBZ3605 For Emergency stop function (3)	Without	Yellow	10	ZBY9140T	0.004/0.009
	ARRET D'URGENCE	Yellow	10	ZBY9130T	0.004/0.009
	EMERGENCY STOP	Yellow	10	ZBY9330T	0.004/0.009
	NOT-HALT	Yellow	10	ZBY9230T	0.004/0.009
Ø 60 mm/2.362 in. legend for padlocking device ZBY93605 For Emergency switching off function (4)	Without	Yellow	10	ZBY9101T	0.004/0.009
	COUPURE D'URGENCE	Yellow	10	ZBY9160T	0.004/0.009
	EMERGENCY SWITCHING OFF	Yellow	10	ZBY9360T	0.004/0.009
	NOT-AUS	Yellow	10	ZBY9260T	0.004/0.009

- (1) Standard circular legends are not compatible with this product. Use special legends ZBY9●●●T.
- (2) No isolation function is possible when this guard is fitted.
- (3) For conformity with standards EN/IEC 60204-1 and EN/ISO 13850.
- (4) For conformity with standard EN/IEC 60204-1.

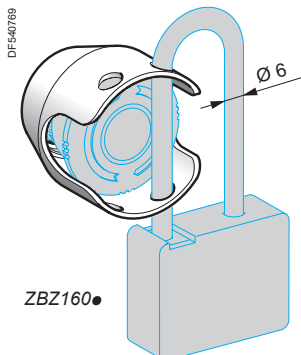

Accessories for mushroom head pushbuttons

Description	Exclusive use with the following Ø 40 mm/1.575 in. trigger action pushbuttons	Color	Reference	Weight kg/lb
Metal guards For Emergency stop and Emergency switching off function Padlockable (1)	XB4BT8●, XB4BS8●, XB4BS9●, ZB4BT8●, ZB4BS8●, ZB4BS9●.	Chromium plated	ZBZ1600	0.046/0.101
		Black	ZBZ1602	0.046/0.101
		Red	ZBZ1604	0.046/0.101
		Yellow	ZBZ1605	0.046/0.101
		Blue	ZBZ1606	0.046/0.101



Circular yellow legends for metal guard ZBZ160●

Description	Marking	Color	Sold in lots of	Reference	Weight kg/lb
for Emergency stop function					
Ø 60 mm/2.362 in. legend for metal guard ZBZ160●	Without	Yellow	10	ZBY9140M	0.004/0.009
	ARRET D'URGENCE	Yellow	10	ZBY9130M	0.004/0.009
	EMERGENCY STOP	Yellow	10	ZBY9330M	0.004/0.009
	NOT-HALT	Yellow	10	ZBY9230M	0.004/0.009
	PARADA DE EMERGENZA	Yellow	10	ZBY9430M	0.004/0.009
	NOODSTOP	Yellow	10	ZBY9530M	0.004/0.009
	ARRESTO DI EMERGENZA	Yellow	10	ZBY9630M	0.004/0.009
	NODSTOPP	Yellow	10	ZBY9730M	0.004/0.009
	NODSTOP	Yellow	10	ZBY9830M	0.004/0.009
	for Emergency switching off function				
Ø 60 mm/2.362 in. legend for metal guard ZBZ160●	Without	Yellow	10	ZBY9101M	0.004/0.009
	COUPURE D'URGENCE	Yellow	10	ZBY9160M	0.004/0.009
	EMERGENCY SWITCHING OFF	Yellow	10	ZBY9360M	0.004/0.009
	NOT-AUS	Yellow	10	ZBY9260M	0.004/0.009
	DESCONEXION DE EMERGENCIA	Yellow	10	ZBY9460M	0.004/0.009
	INTERRUZIONE DI EMERGENZA	Yellow	10	ZBY9660M	0.004/0.009

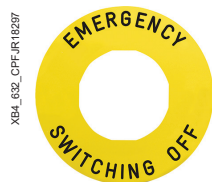

(1) No isolation function is possible when this guard is fitted.



ZBZ2102

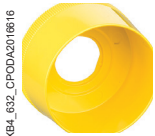

ZB4BZ1905



ZB4BZ2005



ZB4BZ64

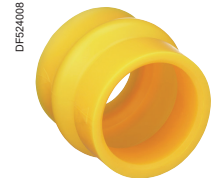

ZBZ58

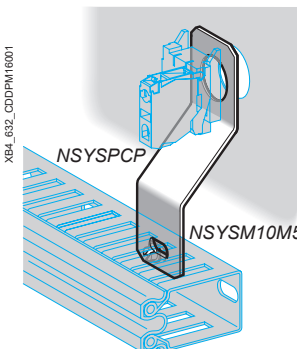

Other accessories

Description	For use with	Color	Reference	Weight kg/lb
Plastic guard	Selector switches and key switches	Black	ZBZ2102	0.005/0.011
	Emergency stop and Emergency switching off function	Yellow Round guard 63.5 mm/ 2.5 in.	ZB4BZ1905	0.005/0.011
		Yellow Round guard 76.2 mm/ 3 in.	ZB4BZ2105	0.005/0.011
Padlockable flaps	Pushbuttons	Yellow Narrow flange guard	ZB4BZ2005	0.005/0.011
		Black	ZB4BZ62	0.076/0.168
		Red	ZB4BZ64	0.076/0.168
		Yellow	ZB4BZ65	0.076/0.168
	Blue	ZB4BZ66	0.076/0.168	

Description	Material	For use with	Color	Sold in lots of	Unit reference	Weight kg/lb
Bellows seals for harsh environments (environments subject to humidity, dust, high-pressure cleaning, etc.) (1)	Silicone	Other functions	Black	2	ZBZ28	0.009/0.020
		Emergency stop/ switching off function	Yellow	2	ZBZ58	0.009/0.020

Description	Application	Sold in lots of	Unit reference	Weight kg/lb
Cable ducting support	Attached beneath head	10	NSYSPCP	0.030/0.066
M5 x 10 screw, with hexagonal slotted head	For attaching cable ducting	100	NSYSM10M5HP	0.003/0.007
Support	For pushbuttons, switches, and pilot lights	1	DX1AP52	0.160/0.353
Boot for contact block ZBE10● and ZBE10●3 (2)	For protection against dusty environment	1	ZBZ60	0.098/0.216

(1) Only when mounted on control stations. Use legends **ZBY9●●●T**.
 (2) Restriction on use: Refer to the product instruction sheet on the Schneider Electric website, Harmony XB4 page.



ZB4SZ3



ZB4BZ007



ZBSP2

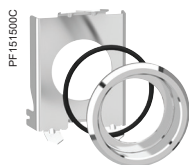

ZB4BZ021

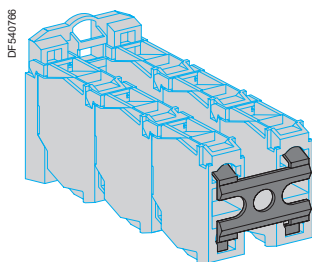

ZBZ007

Other accessories (continued)

Description	For use with	Color	Sold in lots of	Unit reference	Weight kg/lb
Metal circular blanking plug (1)	Ø 22 mm/0.866 in. control and signaling units	Chromium plated	10	ZB4SZ3	0.023/0.051
		Black	10	ZB4SZ37	0.023/0.051
Flush mounted metal circular blanking plug	Ø 30 mm/1.181 in. flush mounted control and signaling units	Chromium plated	10	ZB4FSZ3	0.070/0.154
Plastic blanking plug (with fixing nut)	Ø 22 mm/0.866 in. control and signaling units	Black	10	ZB5SZ3	0.009/0.020
Liquid spray protective washer to be fitted under the head	Ø 22 mm/0.866 in. control and signaling units	Chromium plated	50	ZB4BZ007	0.010/0.022
		Black	50	ZB4BZ0077	0.010/0.022
Spacer for metal flush offer	Ø 30mm/1.181 in. flush mounted control and signaling units	Chromium plated	10	ZB4FBZ007	0.003/0.006
			10	ZB4FBZ010	0.003/0.006
Plastic protection cover IP65/IP67	Ø 22 mm/0.866 in. USB and RJ45 ports	Black	10	ZBSP1	0.002/0.004
Rigid plastic protection cover IP65/IP67	Ø 22 mm/0.866 in. USB and RJ45 ports	Transparent	1	ZBSP2	0.006/0.013
Metal protection cover IP65/IP67/IP69K	Ø 22 mm/0.866 in. USB and RJ45 ports	Silver	1	ZBSP3	0.010/0.022
Ø 30 mm/1.181 in. Flush mounting kit for pushbuttons and pilot lights	Pushbutton ZB4B● with head mounted flush with bezel	Chromium plated	1	ZB4BZ021	0.019/0.042
Ø 30 mm/1.181 in. Flush mounting kit for selector switches and illuminated pushbuttons	Pushbutton ZB4B● with head mounted flush with bezel	Chromium plated	1	ZB4BZ022	0.021/0.046
Ø 30 mm/1.181 in. Flush mounting kit for pushbuttons and pilot lights	Pushbutton ZB4B● with head mounted flush with bezel	Metal black	1	ZB4BZ0217	0.019/0.042
Ø 30 mm/1.181 in. Flush mounting kit for selector switches and illuminated pushbuttons	Pushbutton ZB4B● with head mounted flush with bezel	Metal black	1	ZB4BZ0227	0.021/0.046
Adapter (Ø 30 to Ø 22 mm/1.181 to 0.866 in. reducer)	All pushbuttons	Chromium plated	1	ZB4BZ012	0.023/0.051
Plastic clips	2 or 3 levels of contact blocks ZBE10● in high vibration environment	–	10	ZBZ007	0.001/0.002
Dummy contact block	Contact blocks ZBE10● and transformer blocks ZBV5B	–	5	ZBE000	0.006/0.0123
Set of tabs for Faston connection	Contact blocks ZBE10● and light blocks ZBV●	–	10	ZBZ003	0.001/0.002

(1) Body/fixing collar **ZB4BZ009** required for mounting to be ordered separately (see page 79).



DL1CJ0●●●



DL1CE●●●



DL1CF●●●

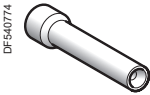

XBFX13

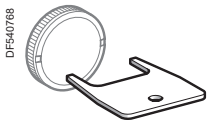

ZBZ8

Bulbs with BA 9s base fitting and associated accessories

Description	Characteristics	Color	Sold in lots of	Unit reference	Weight kg/lb
LEDs	24 V ~	White	1	DL1CJ0241	0.002/0.004
		Green	1	DL1CJ0243	0.002/0.004
		Red	1	DL1CJ0244	0.002/0.004
		Orange	1	DL1CJ0245	0.002/0.004
		Blue	1	DL1CJ0246	0.002/0.004
	48 V ~	Green	1	DL1CJ0483	0.002/0.004
		Red	1	DL1CJ0484	0.002/0.004
		Orange	1	DL1CJ0485	0.002/0.004
	6 V - 1.2 W	White	1	DL1CD0061	0.002/0.004
		Green	1	DL1CD0063	0.002/0.004
		Red	1	DL1CD0064	0.002/0.004
		Orange	1	DL1CD0065	0.002/0.004
		Blue	1	DL1CD0066	0.002/0.004
Incandescent bulbs	6 V - 1.2 W	–	10	DL1CB006	0.002/0.004
	24 V - 2 W	–	10	DL1CE024	0.002/0.004
	120...130 V 2.4 W	–	10	DL1CE130	0.002/0.004
Neon bulbs	120...130 V	–	10	DL1CF110	0.002/0.004
	230...240 V	–	10	DL1CF220	0.002/0.004
Bulb extractor	–	–	1	XBFX13	0.005/0.011
Lens cap tightening tool	Illuminated pushbuttons, with flush push	–	1	ZBZ8	0.009/0.020

Other accessories

Description	Characteristics	Sold in lots of	Unit reference	Weight kg/lb
Anti-rotation plate for flush mounted heads	Selector switches heads ZB4F	10	ZB5FAZ902	0.008/0.018



ZBG455



ZBDLU1



ZBG455P



ZBGP



ZBDD2

Replacement keys

Description	Key number	Reference	Weight kg/lb
For latching mushroom head pushbuttons and selector switches			
Sets of 2 keys	455	ZBG455	0.013/0.029
	421E	ZBG421E	0.014/0.031
	458A	ZBG458A	0.014/0.031
	520E	ZBG520E	0.014/0.031
	3131A	ZBG3131A	0.014/0.031
	4A185	ZBDA185	0.014/0.031
	LU1	ZBDLU1	0.014/0.031
	LU2	ZBDLU2	0.014/0.031
	LU3	ZBDLU3	0.014/0.031
	LU4	ZBDLU4	0.014/0.031
	LU5	ZBDLU5	0.014/0.031
	LU6	ZBDLU6	0.014/0.031
	LU7	ZBDLU7	0.014/0.031
	LU8	ZBDLU8	0.014/0.031
	LU9	ZBDLU9	0.014/0.031
	LU10	ZBDLU10	0.014/0.031
	LU11	ZBDLU11	0.014/0.031
	LU12	ZBDLU12	0.014/0.031
	LU13	ZBDLU13	0.014/0.031
	LU14	ZBDLU14	0.014/0.031
	8D1	ZBD8D1	0.014/0.031
Specific key		ZBGK (1)	0.014/0.031

For booted selector switches

Sets of 2 keys, one of which is supplied booted (rubber boot)	455	ZBG455P	–
	421E	ZBG421EP	–
	458A	ZBG458AP	–
	520E	ZBG520EP	–
	3131A	ZBG3131AP	–

Accessory for key switches (2)

Description	Function	Reference	Weight kg/lb
Keyhole cover (rubber boot)	Protection of lock barrel when no key inserted in lock	ZBGP	0.005/0.011

Boot for standard handle





















Description	For use with	Sold in lots of	Unit reference	Weight kg/lb
Boot for standard handle	ZB4BD●● and ZB5AD●●	10	ZBDD2	0.005/0.011

(1) Key number to be added when ordering.

(2) Not compatible with products with key TEC10.

Product type	Pilot lights	Pushbuttons, selector switches, and pilot lights			Biometric switches	
						
						
						
						
Description of range	<ul style="list-style-type: none"> LED pilot lights 	<ul style="list-style-type: none"> Pushbuttons Multiple-headed pushbuttons Emergency Stop pushbuttons Selector switches and key switches Illuminated pushbuttons Pilot lights Flush mounted pushbuttons, selector switches, and pilot lights (1) 			<ul style="list-style-type: none"> Fingerprint readers 24V ~ Stand-alone biometric switches Stand-alone USB biometric switches USB biometric switches dedicated to Schneider HMI (2) 	
Features	Products	Monolithic, compact, low consumption	Complete units or sub-assemblies (body + head)			Monolithic
	Bezel	Double insulated	Double insulated (4)	Metal, chromium plated, or black	Double insulated	Double insulated, dark gray
	Shape of head	Circular	Circular, square, or rectangular	Circular	Circular or square	–
Drilling or cut-out for fixing		Ø 8 mm and Ø 12 mm/0.315 in. and 0.472 in.	Ø 16 mm/0.630 in.	Ø 22 mm/0.866 in. Ø 30 mm/1.181 in. (for flush mounted control and signaling units)	Ø 22 mm/0.866 in.	
Degree of protection	Conforming to IEC 60529	IP40 IP65 with seal	IP65	IP66, IP67, IP69, and IP69K	IP65 (control button)	
	Conforming to UL 508 and CSA C22-2 No. 14	–	Enclosure type 4, 4X, and 13			Enclosure type 12
Cabling		Tags for 2.8 x 0.5 mm/0.110 x 0.020 in. connectors or threaded connector	Faston connectors Solder pins for printed circuit boards (4) Fast connector socket (5)	Spring clamp terminal connections Screw clamp terminal connections Faston connectors Connector with adapter for printed circuit board	Cable or connectors	
Mounting	Panel thickness	1...8 mm/0.039...0.315 in.	1...6 mm/0.039...0.236 in.			
Type references		XVLA	XB6, XB6E	XB4	XB5	XB5S

(1) Flush mounted control and signaling units are available for Harmony XB4 and XB5 ranges only.
 (2) Compatible with Magelis iPC, STU, OT, GXO, GT (except GT1000 series), GK, GH, and GTO models.
 (3) Wireless and batteryless pushbutton and receiver ready-paired at the factory.

Wireless and batteryless pushbuttons	Pushbuttons, selector switches, and pilot lights	Joystick controllers	Pushbuttons, selector switches, and pilot lights	Cam switches				
								
								
								
								
Description of range	<ul style="list-style-type: none"> Wireless and batteryless pushbuttons and rope pull switch Configurable receivers Access point Relay-antenna Mobile handy box or plastic boxes for wall mounting 	<ul style="list-style-type: none"> Pushbuttons Emergency Stop and Emergency switching off pushbuttons Selector switches and key switches Illuminated pushbuttons Pilot lights 	<ul style="list-style-type: none"> 2- or 4-direction Stay put or spring return 	<ul style="list-style-type: none"> Pushbuttons Emergency Stop pushbuttons Selector switches and key switches Illuminated pushbuttons Pilot lights 	<ul style="list-style-type: none"> Switches Stepping switches Reversing and changeover switches Ammeter switches Voltmeter switches Reversing switches Star-delta and reversing star-delta switches Pole change switches 			
Features	Products	Ready-to-use packs (3) and "components" range	Monolithic	Complete units or sub-assemblies (body + head with lever)	Complete units or sub-assemblies (body + head)	Complete units or sub-assemblies (body + front panel+ head)		
	Bezel	Metal, chromium plated, or double insulated, black	Double insulated, dark gray (or white for pilot lights)	Metal, chromium plated	Double insulated, black	Metal, chromium plated, or double insulated, black		
	Shape of head	Transmitter with circular head	Circular	Circular	Hexagonal	Square		
Drilling or cut-out for fixing		Ø 22 mm/0.866 in.			Ø 30 mm/1.181 in.	Ø 16 or Ø 22 mm/0.630 or 0.866 in.: series K10 Ø 22 mm/0.866 in. and multifixing: series K1/K2 4 holes, 48 or 68 centers: series K30...K150		
Degree of protection	Conforming to IEC 60529	IP65	IP65 (control buttons and pilot lights) IP54 (Emergency switching off pushbuttons)	IP65	IP66	IP65: series K10 IP40, IP65 with seal: series K1/K2 IP40: series K30...K150		
	Conforming to UL 508 and CSA C22-2 No. 14	Enclosure type 12	Enclosure type 3 (pushbuttons and Emergency stop) and 4 (pilot lights)	Enclosure type 4, 4X and 13	Enclosure type 4 and 13 (9001K) Enclosure type 4, 4X, 13 (9001SK)	–		
Cabling		Wireless (transmitter) Through cable (receiver)	Screw and captive clamp terminal connections Faston clip connections (pilot lights)	Screw and captive clamp terminal connections				
Mounting	Panel thickness	1...6 mm/0.039...0.236 in.				0.5...6 mm/0.020...0.236 in. (depending on model)		
Type references		XB5R, XB4R	XB7	XD4PA	XD2GA	XD5PA	9001K, 9001SK	K10, K1, K2, K30, K50, K63, K115, K150

(4) For Harmony XB6 only.
 (5) For Harmony XB6E only.

A					
APE1C2150	81	XB4BD912R10K	72	XB4BV44	68
APE1C2250	81	XB4BD912R47K	72	XB4BV45	68
APE1PRE21	81	XB4BD912R100K	72	XB4BV61	68
		XB4BD912R470K	72	XB4BV63	68
		XB4BG03	56	XB4BV64	68
D		XB4BG21	56	XB4BV65	68
DL1CB006	108	XB4BG33	56	XB4BVB1	66
DL1CD0061	108	XB4BG41	56	XB4BVB3	66
DL1CD0063	108	XB4BG61	56	XB4BVB4	66
DL1CD0064	108	XB4BJ21	55	XB4BVB5	66
DL1CD0065	108	XB4BJ33	55	XB4BV66	66
DL1CD0066	108	XB4BJ53	55	XB4BV67	66
DL1CE024	108	XB4BK123B5	58	XB4BV68	66
DL1CE130	108	XB4BK123G5	58	XB4BV69	66
DL1CF110	108	XB4BK123M5	58	XB4BV70	66
DL1CF220	108	XB4BK124B5	58	XB4BV71	66
DL1CJ0241	108	XB4BK124G5	58	XB4BV72	66
DL1CJ0243	108	XB4BK124M5	58	XB4BV73	66
DL1CJ0244	108	XB4BK125B5	58	XB4BV74	66
DL1CJ0245	108	XB4BK125G5	58	XB4BV75	66
DL1CJ0246	108	XB4BK125M5	58	XB4BV76	66
DL1CJ0483	108	XB4BK133B5	58	XB4BVM1	66
DL1CJ0484	108	XB4BK133G5	58	XB4BVM3	66
DL1CJ0485	108	XB4BK133M5	58	XB4BVM4	66
DX1AP52	106	XB4BK134B5	58	XB4BVM5	66
				XB4BVM6	66
				XB4BW21B5	69
				XB4BW21G5	69
				XB4BW23B5	69
				XB4BW23G5	69
				XB4BW24B5	69
				XB4BW24G5	69
				XB4BW25B5	69
				XB4BW25G5	69
				XB4BW26B5	69
				XB4BW26G5	69
				XB4BW28B5	69
				XB4BW28G5	69
				XB4BW31B5	30
				XB4BW31G5	30
				XB4BW31M5	30
				XB4BW33B5	30
				XB4BW33G5	30
				XB4BW33M5	30
				XB4BW34B5	30
				XB4BW34G5	30
				XB4BW34M5	30
				XB4BW35B5	30
				XB4BW35G5	30
				XB4BW35M5	30
				XB4BW36B5	30
				XB4BW36G5	30
				XB4BW36M5	30
				XB4BW3135	33
				XB4BW3145	33
				XB4BW3165	33
				XB4BW3335	33
				XB4BW3345	33
				XB4BW3365	33
				XB4BW3435	33
				XB4BW3445	33
				XB4BW3465	33
				XB4BW3535	33
				XB4BW3545	33
				XB4BW3565	33
				XB4BW73731B5	40
				XB4BW73731G5	40
				XB4BW73731M5	40
				XB4FA11	34
				XB4FA21	34
				XB4FA31	34
				XB4FA42	34
				XB4FA51	34
				XB4FA61	34
				XB4FA3311	36
				XB4FA3341	36
				XB4FA3351	36
				XB4FA4322	36
				XB4FD21	60
				XB4FD25	60
				XB4FD33	60
				XB4FD41	60
				XB4FD53	60
				XB4FG03	62
				XB4FG21	62
				XB4FG33	62
				XB4FG41	62
				XB4FG61	62
				XB4FJ21	61
				XB4FJ33	61
				XB4FJ53	61
				XB4FK123B5	64
				XB4FK123G5	64
				XB4FK123M5	64
				XB4FK124B5	64
				XB4FK124G5	64
				XB4FK124M5	64
				XB4FK125B5	64
				XB4FK125G5	64
				XB4FK125M5	64
				XB4FK133B5	64
				XB4FK133G5	64
				XB4FK133M5	64
				XB4FK134B5	64
				ZB4FK1343	64
					65
				XB4FK134G5	64
				XB4FK134M5	64
				XB4FK135B5	64
				XB4FK135G5	64
				XB4FK135M5	64
				XB4FL42	35
				XB4FL4325	36
				XB4FVB1	70
				XB4FVB3	70
				XB4FVB4	70
				XB4FVB5	70
				XB4FVB6	70
				XB4FVG1	70
				XB4FVG3	70
				XB4FVG4	70
				XB4FVG5	70
				XB4FVG6	70
				XB4FVM1	70
				XB4FVM3	70
				XB4FVM4	70
				XB4FVM5	70
				XB4FVM6	70
				XB4FW31B5	37
				XB4FW31G5	37
				XB4FW31M5	37
				XB4FW33B5	37
				XB4FW33G5	37
				XB4FW33M5	37
				XB4FW34B5	37
				XB4FW34G5	37
				XB4FW34M5	37
				XB4FW35B5	37
				XB4FW35G5	37
				XB4FW35M5	37
				XB4FW36B5	37
				XB4FW36G5	37
				XB4FW36M5	37
				XB5DSB	73
				XB5DSG	73
				XB5DSM	73
				XB5DT1S	73
				XB5DTB22	73
				XB5DTB23	73
				XB5DTB24	73
				XB5DTB25	73
				XB5DTGM2	73
				XB5DTGM3	73
				XB5DTGM4	73
				XB5DTGM5	73
				XB5KS2B4	73
				XB5KS2B8	73
				XB5KS2G4	73
				XB5KS2G8	73
				XB5KS2M4	73
				XB5KS2M8	73
				XB5KSB	73
				XB5KSG	73
				XB5KSM	73
				XB5PRJ45	73
				XB5PUSB3	73
				XBFX13	108
				XD4PA12	74
				XD4PA14	74
				XD4PA22	74
				XD4PA24	74
				ZB2BE101	76
				ZB2BE102	76
				ZB4BA0	26
				ZB4BA1	26
				ZB4BA2	26
				ZB4BA3	26
				ZB4BA4	26
				ZB4BA5	26
				ZB4BA6	26
				ZB4BA8	26
				ZB4BA9	26
				ZB4BA14	26
				ZB4BA16	28
				ZB4BA18	26
					31
				ZB4BA24	26
				ZB4BA26	28
				ZB4BA34	26
				ZB4BA36	28
				ZB4BA38	26
					31

ZB4BA44	26	ZB4BC180	48	ZB4BH04	50	ZB4BL4	27	ZB4BS964	45
ZB4BA46	28	ZB4BC280	48	ZB4BH4	50	ZB4BL5	27	ZB4BT2	43
ZB4BA48	26	ZB4BC380	48	ZB4BH05	50	ZB4BL6	27	ZB4BT84	45
	31	ZB4BC480	48	ZB4BH5	50	ZB4BL232	29	ZB4BT844	45
ZB4BA54	26	ZB4BC580	48	ZB4BH06	50	ZB4BL233	29	ZB4BV01	68
ZB4BA56	28	ZB4BC680	48	ZB4BH6	50	ZB4BL234	29	ZB4BV01S	68
ZB4BA58	26	ZB4BC780	48	ZB4BH013	51	ZB4BL235	29	ZB4BV003	67
	31	ZB4BC980	48	ZB4BH13	51	ZB4BL432	29	ZB4BV03	68
ZB4BA64	26	ZB4BC18023	48	ZB4BH033	51	ZB4BL433	29	ZB4BV3	87
ZB4BA66	28	ZB4BC28001	48	ZB4BH33	51	ZB4BL434	29	ZB4BV3D1	87
ZB4BA68	26	ZB4BC28021	48	ZB4BH043	51	ZB4BL435	29	ZB4BV3D3	87
	31	ZB4BC38023	48	ZB4BH43	51	ZB4BL7340	40	ZB4BV3D4	87
ZB4BA79	40	ZB4BC48021	48	ZB4BH053	51	ZB4BL7341	40	ZB4BV3D5	87
ZB4BA88	31	ZB4BD2	54	ZB4BH53	51	ZB4BP1	28	ZB4BV3D6	87
ZB4BA98	26	ZB4BD3	54	ZB4BH063	51	ZB4BP1S	28	ZB4BV03S	68
	31	ZB4BD4	54	ZB4BH63	51		90	ZB4BV04	68
ZB4BA131	29	ZB4BD5	54	ZB4BH083	51	ZB4BP2	28	ZB4BV4	87
ZB4BA133	29	ZB4BD7	54	ZB4BH83	51	ZB4BP2S	28	ZB4BV4D1	87
ZB4BA136	29	ZB4BD8	54	ZB4BJ2	55		90	ZB4BV4D3	87
ZB4BA141	29	ZB4BD28	57	ZB4BJ3	55	ZB4BP3	28	ZB4BV4D4	87
ZB4BA142	29	ZB4BD29	57	ZB4BJ4	55	ZB4BP3S	28	ZB4BV4D5	87
ZB4BA145	29	ZB4BD39	57	ZB4BJ5	55		90	ZB4BV4D6	87
ZB4BA232	29	ZB4BD48	57	ZB4BJ7	55	ZB4BP4	28	ZB4BV04S	68
ZB4BA233	29	ZB4BD49	57	ZB4BJ8	55	ZB4BP4S	28	ZB4BV05	68
ZB4BA234	29	ZB4BD59	57	ZB4BK1213	59		90	ZB4BV5	87
ZB4BA235	29	ZB4BD79	57	ZB4BK1233	59	ZB4BP5	28	ZB4BV5D1	87
ZB4BA245	29	ZB4BD89	57	ZB4BK1243	59	ZB4BP5S	28	ZB4BV5D3	87
ZB4BA331	29	ZB4BD912	72	ZB4BK1253	59		90	ZB4BV5D4	87
ZB4BA333	29	ZB4BD922	72	ZB4BK1263	59	ZB4BP6	28	ZB4BV5D5	87
ZB4BA334	29	ZB4BG0	56	ZB4BK1283	59	ZB4BP6S	28	ZB4BV5D6	87
ZB4BA335	29	ZB4BG0TEC10	57	ZB4BK1313	59		90	ZB4BV05S	68
ZB4BA336	29	ZB4BG1	56	ZB4BK1333	59	ZB4BP18	28	ZB4BV06	68
ZB4BA341	29	ZB4BG01	56	ZB4BK1353	59	ZB4BP38	28	ZB4BV6	87
ZB4BA342	29	ZB4BG2	56	ZB4BK1363	59	ZB4BP48	28	ZB4BV06S	68
ZB4BA343	29	ZB4BG02	56	ZB4BK1383	59	ZB4BP58	28	ZB4BV07	68
ZB4BA434	29	ZB4BG2TEC10	57	ZB4BK1413	59	ZB4BP68	28	ZB4BV07S	68
ZB4BA435	29	ZB4BG3	56	ZB4BK1433	59	ZB4BP183	28	ZB4BV8	87
ZB4BA791	41	ZB4BG03	56	ZB4BK1443	59	ZB4BP383	28	ZB4BV9	87
ZB4BA7120	40	ZB4BG3TEC10	57	ZB4BK1453	59	ZB4BP483	28	ZB4BV9	87
ZB4BA7121	40	ZB4BG4	56	ZB4BK1463	59	ZB4BP583	28	ZB4BV013	67
ZB4BA7340	40	ZB4BG04	56	ZB4BK1483	59	ZB4BP683	28	ZB4BV013E	67
ZB4BA7341	40	ZB4BG4TEC10	57	ZB4BK1513	59	ZB4BR2	42	ZB4BV013S	67
ZB4BA71115	41	ZB4BG5	56	ZB4BK1533	59	ZB4BR3	42	ZB4BV18B1	85
ZB4BA71123	41	ZB4BG05	56	ZB4BK1543	59	ZB4BR4	42	ZB4BV18B3	85
ZB4BA71124	41	ZB4BG5TEC10	57	ZB4BK1553	59	ZB4BR5	42	ZB4BV18B4	85
ZB4BA72124	41	ZB4BG05TEC10	57	ZB4BK1563	59	ZB4BR6	42	ZB4BV18B5	85
ZB4BA73132	41	ZB4BG6	56	ZB4BK1583	59	ZB4BR216	42	ZB4BV18B6	85
ZB4BA73133	41	ZB4BG6TEC10	57	ZB4BK1713	59	ZB4BR316	42	ZB4BV18G1	85
ZB4BA73134	41	ZB4BG7	56	ZB4BK1733	59	ZB4BR416	42	ZB4BV18G3	85
ZB4BA73135	41	ZB4BG7TEC10	57	ZB4BK1743	59	ZB4BR516	42	ZB4BV18G4	85
ZB4BB2	75	ZB4BG8	56	ZB4BK1753	59	ZB4BR616	42	ZB4BV18G5	85
ZB4BB4	75	ZB4BG08	56	ZB4BK1763	59	ZB4BS12	43	ZB4BV18G6	85
ZB4BC2	42	ZB4BG9	56	ZB4BK1783	59	ZB4BS22	43	ZB4BV18M1	85
ZB4BC3	42	ZB4BG09	56	ZB4BK1813	59	ZB4BS42	43	ZB4BV18M3	85
ZB4BC4	42	ZB4BG9TEC10	57	ZB4BK1833	59	ZB4BS52	43	ZB4BV18M4	85
ZB4BC5	42	ZB4BH0	50	ZB4BK1843	59	ZB4BS55	43	ZB4BV18M5	85
ZB4BC6	42	ZB4BH01	50	ZB4BK1853	59	ZB4BS62	43	ZB4BV18M6	85
ZB4BC24	42	ZB4BH1	50	ZB4BK1863	59	ZB4BS72	43	ZB4BV033	67
ZB4BC34	42	ZB4BH02	50	ZB4BK1883	59	ZB4BS834	45	ZB4BV033E	67
ZB4BC44	42	ZB4BH2	50	ZB4BL1	27	ZB4BS844	45	ZB4BV033S	67
ZB4BC54	42	ZB4BH03	50	ZB4BL2	27	ZB4BS864	45	ZB4BV043	67
ZB4BC64	42	ZB4BH3	50	ZB4BL3	27	ZB4BS934	45	ZB4BV043E	67
						ZB4BS944	45	ZB4BV043S	67

ZB4BV053	67	ZB4BW0G12	82	ZB4BW7L3741	40	ZB4BW453	42	ZB4BZ2105	106
ZB4BV053E	67	ZB4BW0G13	82	ZB4BW11	33	ZB4BW463	42	ZB4FA0	34
ZB4BV053S	67	ZB4BW0G15	82	ZB4BW11S	33	ZB4BW513	31	ZB4FA1	34
ZB4BV063	67	ZB4BW0G31	82	ZB4BW13	33	ZB4BW533	31	ZB4FA2	34
ZB4BV063E	67	ZB4BW0G32	82	ZB4BW13S	33	ZB4BW543	31	ZB4FA3	34
ZB4BV063S	67	ZB4BW0G33	82	ZB4BW14	33	ZB4BW553	31	ZB4FA3M33	34
ZB4BV083	67	ZB4BW0G35	82	ZB4BW14S	33	ZB4BW563	31	ZB4FA4	34
ZB4BV083E	67	ZB4BW0G41	82	ZB4BW15	33	ZB4BW583	31	ZB4FA5	34
ZB4BV083S	67	ZB4BW0G42	82	ZB4BW15S	33	ZB4BW613	43	ZB4FA6	34
ZB4BV156	87	ZB4BW0G43	82	ZB4BW16	33	ZB4BW633	43	ZB4FA8	34
ZB4BVB1	84	ZB4BW0G45	82	ZB4BW16S	33	ZB4BW643	47	ZB4FA9	34
ZB4BVB3	84	ZB4BW0G51	82	ZB4BW17	33	ZB4BW653	43	ZB4FA16	34
ZB4BVB4	84	ZB4BW0G52	82	ZB4BW17S	33	ZB4BW663	43	ZB4FA18	34
ZB4BVB5	84	ZB4BW0G53	82	ZB4BW31	33	ZB4BW913	31		38
ZB4BVB6	84	ZB4BW0G55	82	ZB4BW031	86	ZB4BW933	31	ZB4FA26	34
ZB4BVB1156	85	ZB4BW0G61	82	ZB4BW31S	33	ZB4BW943	31	ZB4FA36	34
ZB4BVB3156	85	ZB4BW0G62	82	ZB4BW33	33	ZB4BW953	31	ZB4FA38	34
ZB4BVB4156	85	ZB4BW0G63	82	ZB4BW33S	33	ZB4BW963	31		38
ZB4BVB5156	85	ZB4BW0G65	82	ZB4BW34	33	ZB4BW983	31	ZB4FA46	34
ZB4BVB6156	85	ZB4BW0M11	83	ZB4BW34S	33	ZB4BX2	43	ZB4FA48	34
ZB4BVBG1	84	ZB4BW0M12	83	ZB4BW35	33	ZB4BX84	45		38
ZB4BVBG3	84	ZB4BW0M13	83	ZB4BW35S	33	ZB4BZ007	107	ZB4FA56	34
ZB4BVBG4	84	ZB4BW0M15	83	ZB4BW35S	33	ZB4BZ009	76	ZB4FA58	34
ZB4BVBG5	84	ZB4BW0M31	83	ZB4BW36	33		78		38
ZB4BVBG6	84	ZB4BW0M32	83	ZB4BW36S	33		79	ZB4FA66	34
ZB4BVG1	84	ZB4BW0M33	83	ZB4BW37	33		81	ZB4FA68	34
ZB4BVG3	84	ZB4BW0M35	83	ZB4BW37S	33	ZB4BZ012	107		38
ZB4BVG4	84	ZB4BW0M41	83	ZB4BW041	86	ZB4BZ021	107	ZB4FA88	36
ZB4BVG5	84	ZB4BW0M42	83	ZB4BW045	86	ZB4BZ022	107	ZB4FA131	36
ZB4BVG6	84	ZB4BW0M43	83	ZB4BW051	86	ZB4BZ62	106	ZB4FA133	36
ZB4BVG35	78	ZB4BW0M45	83	ZB4BW055	86	ZB4BZ64	106	ZB4FA136	36
ZB4BVG45	78	ZB4BW0M51	83	ZB4BW061	86	ZB4BZ65	106	ZB4FA141	36
ZB4BVJ1	84	ZB4BW0M52	83	ZB4BW062	86	ZB4BZ66	106	ZB4FA142	36
ZB4BVJ3	84	ZB4BW0M53	83	ZB4BW063	86	ZB4BZ66	106	ZB4FA145	36
ZB4BVJ4	84	ZB4BW0M55	83	ZB4BW065	86	ZB4BZ0077	107	ZB4FA232	36
ZB4BVJ5	84	ZB4BW0M61	83	ZB4BW065	86	ZB4BZ079	79	ZB4FA233	36
ZB4BVJ6	84	ZB4BW0M62	83	ZB4BW113	32	ZB4BZ101	76	ZB4FA234	36
ZB4BVM1	84	ZB4BW0M63	83	ZB4BW113S	32	ZB4BZ102	76	ZB4FA235	36
ZB4BVM3	84	ZB4BW0M65	83	ZB4BW133	32	ZB4BZ103	76	ZB4FA245	36
ZB4BVM4	84	ZB4BW03D15	86	ZB4BW133S	32	ZB4BZ104	76	ZB4FA245	36
ZB4BVM5	84	ZB4BW03D35	86	ZB4BW143	32	ZB4BZ105	76	ZB4FA331	36
ZB4BVM6	84	ZB4BW03D45	86	ZB4BW143S	32	ZB4BZ106	76	ZB4FA333	36
ZB4BW0B11	82	ZB4BW03D45	86	ZB4BW153	32	ZB4BZ107	76	ZB4FA334	36
ZB4BW0B12	82	ZB4BW03D55	86	ZB4BW153S	32	ZB4BZ141	76	ZB4FA335	36
ZB4BW0B13	82	ZB4BW03D65	86	ZB4BW163	32	ZB4BZ2017	107	ZB4FA336	36
ZB4BW0B15	82	ZB4BW04D15	86	ZB4BW163S	32	ZB4BZ2027	107	ZB4FA341	36
ZB4BW0B31	82	ZB4BW04D35	86	ZB4BW183	32	ZB4BZ1013	80	ZB4FA342	36
ZB4BW0B32	82	ZB4BW04D45	86	ZB4BW183S	32	ZB4BZ1014	81	ZB4FA432	36
ZB4BW0B33	82	ZB4BW04D55	86	ZB4BW183S	32	ZB4BZ1014	81	ZB4FA433	36
ZB4BW0B35	82	ZB4BW04D65	86	ZB4BW313	31	ZB4BZ1015	78	ZB4FA434	36
ZB4BW0B41	82	ZB4BW05D15	86	ZB4BW313S	31	ZB4BZ1023	80	ZB4FA434	36
ZB4BW0B42	82	ZB4BW05D35	86	ZB4BW333	31	ZB4BZ1024	81	ZB4FA435	36
ZB4BW0B43	82	ZB4BW05D45	86	ZB4BW333S	31	ZB4BZ1025	78	ZB4FBZ007	107
ZB4BW0B51	82	ZB4BW05D55	86	ZB4BW343	31	ZB4BZ1033	80	ZB4FBZ010	107
ZB4BW0B52	82	ZB4BW05D65	86	ZB4BW343S	31	ZB4BZ1034	81	ZB4FD2	60
ZB4BW0B53	82	ZB4BW7A9	40	ZB4BW353	31	ZB4BZ1035	78	ZB4FD2M178	60
ZB4BW0B55	82	ZB4BW7A1715	40	ZB4BW353S	31	ZB4BZ1043	80	ZB4FD3	60
ZB4BW0B61	82	ZB4BW7A1720	40	ZB4BW363	31	ZB4BZ1044	81	ZB4FD4	60
ZB4BW0B62	82	ZB4BW7A1721	40	ZB4BW363S	31	ZB4BZ1045	78	ZB4FD5	60
ZB4BW0B63	82	ZB4BW7A1724	40	ZB4BW383	31	ZB4BZ1053	80	ZB4FD7	60
ZB4BW0B65	82	ZB4BW7A3740	40	ZB4BW383S	31	ZB4BZ1054	81	ZB4FD8	60
ZB4BW0B65	82	ZB4BW7A3741	40	ZB4BW413	42	ZB4BZ1055	78	ZB4FD29	63
ZB4BW0G11	82	ZB4BW7L3740	40	ZB4BW433	42	ZB4BZ1414	81	ZB4FD39	63
				ZB4BW443	42	ZB4BZ1905	106	ZB4FD59	63
						ZB4BZ2005	106	ZB4FD79	63

ZB4FD89	63	ZB4FK1443	65	ZB4SZ3	107	ZBAF341	89	ZBE5023	80
ZB4FG0	62	ZB4FK1453	65	ZB4SZ37	107	ZBAF342	89	ZBE5033	80
ZB4FG1	62	ZB4FK1463	65	ZB5FAZ902	108	ZBAF343	89	ZBE5043	80
ZB4FG01	62	ZB4FK1483	65	ZB5SZ3	107	ZBAF344	89	ZBE5053	80
ZB4FG2	62	ZB4FK1513	65	ZBA1	88	ZBAF346	89	ZBE7016	79
ZB4FG02	62	ZB4FK1533	65	ZBA2	88	ZBAF432	89	ZBE7026	79
ZB4FG03	62	ZB4FK1543	65	ZBA3	88	ZBAF433	89	ZBE10163	80
ZB4FG3	62	ZB4FK1553	65	ZBA4	88	ZBAF434	89	ZBE10263	80
ZB4FG4	62	ZB4FK1563	65	ZBA5	88	ZBAF435	89	ZBG421E	109
ZB4FG04	62	ZB4FK1583	65	ZBA6	88	ZBAF639	89	ZBG421EP	109
ZB4FG5	62	ZB4FK1713	65	ZBA9	88	ZBAF2934	89	ZBG455	109
ZB4FG05	62	ZB4FK1733	65	ZBA131	88	ZBAF2935	89	ZBG455P	109
ZB4FG6	62	ZB4FK1743	65	ZBA133	88	ZBD8D1	109	ZBG458A	109
ZB4FG7	62	ZB4FK1753	65	ZBA136	88	ZBDA185	109	ZBG458AP	109
ZB4FG8	62	ZB4FK1763	65	ZBA137	88	ZBDD2	109	ZBG520E	109
ZB4FG08	62	ZB4FK1783	65	ZBA141	88	ZBDLU1	109	ZBG520EP	109
ZB4FG9	62	ZB4FK1813	65	ZBA142	88	ZBDLU2	109	ZBG2201	74
ZB4FG09	62	ZB4FK1833	65	ZBA145	88	ZBDLU3	109	ZBG2401	74
ZB4FH0	52	ZB4FK1843	65	ZBA232	88	ZBDLU4	109	ZBG3131A	109
ZB4FH01	52	ZB4FK1853	65	ZBA233	88	ZBDLU5	109	ZBG3131AP	109
ZB4FH1	52	ZB4FK1863	65	ZBA234	88	ZBDLU6	109	ZBG4201	74
ZB4FH02	52	ZB4FK1883	65	ZBA235	88	ZBDLU7	109	ZBG4401	74
ZB4FH2	52	ZB4FL1	35	ZBA245	88	ZBDLU8	109	ZBGK	109
ZB4FH03	52	ZB4FL2	35	ZBA331	88	ZBDLU9	109	ZBGP	109
ZB4FH3	52	ZB4FL3	35	ZBA333	88	ZBDLU10	109	ZBL1	88
ZB4FH04	52	ZB4FL4	35	ZBA334	88	ZBDLU11	109	ZBL2	88
ZB4FH4	52	ZB4FL4M34	35	ZBA335	88	ZBDLU12	109	ZBL3	88
ZB4FH05	52	ZB4FL5	35	ZBA336	88	ZBDLU13	109	ZBL4	88
ZB4FH5	52	ZB4FL6	35	ZBA337	88	ZBDLU14	109	ZBL5	88
ZB4FH06	52	ZB4FL232	36	ZBA338	88	ZBE000	107	ZBL6	88
ZB4FH6	52	ZB4FL233	36	ZBA341	88	ZBE101	76	ZBL9	88
ZB4FH013	53	ZB4FL234	36	ZBA342	88	ZBE102	76	ZBA138	88
ZB4FH13	53	ZB4FL235	36	ZBA343	88	ZBE201	76	ZBP0	90
ZB4FH033	53	ZB4FL432	36	ZBA344	88	ZBE202	76	ZBP0A	90
ZB4FH33	53	ZB4FL433	36	ZBA346	88	ZBE203	76	ZBP011	90
ZB4FH043	53	ZB4FL434	36	ZBA432	88	ZBE204	76	ZBP012	90
ZB4FH43	53	ZB4FL435	36	ZBA433	88	ZBE205	76	ZBP013	90
ZB4FH053	53	ZB4FSZ3	107	ZBA434	88	ZBE501	76	ZBP014	90
ZB4FH53	53	ZB4FV013	71	ZBA435	88	ZBE502	76	ZBP015	90
ZB4FH063	53	ZB4FV033	71	ZBA639	88	ZBE503	76	ZBP016	90
ZB4FH63	53	ZB4FV043	71	ZBA2934	88	ZBE504	76	ZBP017	90
ZB4FH083	53	ZB4FV053	71	ZBA2935	88	ZBE505	76	ZBPA	90
ZB4FH83	53	ZB4FV063	71	ZBAF131	89	ZBE701	79	ZBSP1	107
ZB4FJ2	61	ZB4FV083	71	ZBAF133	89	ZBE702	79	ZBSP2	107
ZB4FJ3	61	ZB4FW113	39	ZBAF136	89	ZBE1013	80	ZBSP3	107
ZB4FJ4	61	ZB4FW133	39	ZBAF137	89	ZBE1014	81	ZBV5B	77
ZB4FJ5	61	ZB4FW143	39	ZBAF138	89	ZBE1015	78	ZBV6	87
ZB4FJ7	61	ZB4FW153	39	ZBAF141	89	ZBE1016	76	ZBV011	91
ZB4FJ8	61	ZB4FW163	39	ZBAF142	89	ZBE1016P	76	ZBV013	91
ZB4FK1213	65	ZB4FW183	39	ZBAF145	89	ZBE1016P3	80	ZBV014	91
ZB4FK1233	65	ZB4FW313	38	ZBAF232	89	ZBE1023	80	ZBV015	91
ZB4FK1243	65	ZB4FW333	38	ZBAF233	89	ZBE1024	81	ZBV016	91
ZB4FK1253	65	ZB4FW343	38	ZBAF234	89	ZBE1025	78	ZBV017	91
ZB4FK1263	65	ZB4FW353	38	ZBAF235	89	ZBE1026	76	ZBV18B1	77
ZB4FK1283	65	ZB4FW363	38	ZBAF245	89	ZBE1026P	76	ZBV18B3	77
ZB4FK1313	65	ZB4FW383	38	ZBAF331	89	ZBE1026P3	80	ZBV18B4	77
ZB4FK1333	65	ZB4FW913	38	ZBAF333	89	ZBE2013	80	ZBV18B5	77
ZB4FK1353	65	ZB4FW933	38	ZBAF334	89	ZBE2023	80	ZBV18B6	77
ZB4FK1363	65	ZB4FW943	38	ZBAF335	89	ZBE2033	80	ZBV18G1	77
ZB4FK1383	65	ZB4FW953	38	ZBAF336	89	ZBE2043	80	ZBV18G3	77
ZB4FK1413	65	ZB4FW963	38	ZBAF337	89	ZBE2053	80	ZBV18G4	77
ZB4FK1433	65	ZB4FW983	38	ZBAF338	89	ZBE5013	80	ZBV18G5	77

ZBV18G6	77	ZBVJ55	78	ZBY9W2G230	46	ZBY2103	92	ZBY2166	92
ZBV18M1	77	ZBVJ65	78		103	ZBY02103	95	ZBY02166	95
ZBV18M3	77	ZBVM1	77	ZBY9W2G330	46	ZBY2103C0	92	ZBY2166C0	92
ZBV18M4	77	ZBVM3	77		103	ZBY2104	92	ZBY2167	92
ZBV18M5	77	ZBVM4	77	ZBY9W2G430	46	ZBY02104	95	ZBY02167	95
ZBV18M6	77	ZBVM5	77		103	ZBY2104C0	92	ZBY2178	92
ZBV0103S	91	ZBVM6	77	ZBY9W2G630	46	ZBY2105	92	ZBY02178	95
ZBV0113	91	ZBVM8	77		103	ZBY02105	95	ZBY2178C0	92
ZBV0133	91	ZBVM14	81	ZBY9W2M101	101	ZBY2106	92	ZBY2179	92
ZBV0143	91	ZBVM15	78		103	ZBY02106	95	ZBY02179	95
ZBV0153	91	ZBVM34	81	ZBY9W2M140	46	ZBY2107	92	ZBY2184	92
ZBV0163	91	ZBVM35	78		103	ZBY02107	95	ZBY02184	95
ZBVB1	77	ZBVM44	81	ZBY9W2M230	46	ZBY2108	92	ZBY2185	92
ZBVB3	77	ZBVM45	78		103	ZBY02108	95	ZBY02185	95
ZBVB4	77	ZBVM54	81	ZBY9W2M330	46	ZBY2109	92	ZBY2186	92
ZBVB5	77	ZBVM55	78		103	ZBY02109	95	ZBY02186	95
ZBVB6	77	ZBVM64	81	ZBY9W2M430	46	ZBY2110	92	ZBY2186C0	92
ZBVB8	77	ZBVM65	78		103	ZBY02110	95	ZBY2195	92
ZBVB14	81	ZBW911	91	ZBY9W3B101	101	ZBY2111	92	ZBY02195	95
ZBVB15	78	ZBW913	91		103	ZBY02111	95	ZBY2196	92
ZBVB17	79	ZBW914	91	ZBY9W3B130	46	ZBY2112	92	ZBY02196	95
ZBVB34	81	ZBW915	91		103	ZBY02112	95	ZBY2197	92
ZBVB35	78	ZBW916	91	ZBY9W3B140	46	ZBY2113	92	ZBY02197	95
ZBVB37	79	ZBW917	91		103	ZBY02113	95	ZBY2198	92
ZBVB44	81	ZBW931	91	ZBY9W3B230	46	ZBY2114	92	ZBY02198	95
ZBVB45	78	ZBW933	91		103	ZBY02114	95	ZBY2199	92
ZBVB47	79	ZBW934	91	ZBY9W3B330	46	ZBY2115	92	ZBY02199	95
ZBVB54	81	ZBW935	91		103	ZBY02115	95	ZBY2203	93
ZBVB55	78	ZBW936	91	ZBY9W3B430	46	ZBY2116	92	ZBY02203	97
ZBVB57	79	ZBW937	91		103	ZBY02116	95	ZBY2204	93
ZBVB64	81	ZBW9113	91	ZBY0101	95	ZBY2123	92	ZBY02204	97
ZBVB65	78	ZBW9133	91	ZBY0102	95	ZBY02123	95	ZBY2205	93
ZBVB67	79	ZBW9143	91	ZBY0104	92	ZBY2126	92	ZBY02205	97
ZBVBG1	77	ZBW9153	91	ZBY00104	95	ZBY02126	95	ZBY2206	93
ZBVBG3	77	ZBW9163	91	ZBY0123	92	ZBY2127	92	ZBY02206	97
ZBVBG4	77	ZBW9313	91	ZBY00123	95	ZBY02127	95	ZBY2207	93
ZBVBG5	77	ZBW9333	91	ZBY0140	95	ZBY2128	92	ZBY02207	97
ZBVBG6	77	ZBW9343	91	ZBY1101	100	ZBY02128	95	ZBY2208	93
ZBVG1	77	ZBW9353	91	ZBY1103	100	ZBY2129	92	ZBY02208	97
ZBVG3	77	ZBW9363	91	ZBY1104	100	ZBY02129	95	ZBY2209	93
ZBVG4	77	ZBY001	76	ZBY1105	100	ZBY02130	95	ZBY02209	97
ZBVG5	77		78	ZBY1106	100	ZBY2130	92	ZBY2210	93
ZBVG6	77		80	ZBY1107	100	ZBY2131	92	ZBY02210	97
ZBVG8	77	ZBY2H101	92	ZBY1108	100	ZBY02131	95	ZBY2211	93
ZBVG14	81	ZBY4H101	92	ZBY1115	100	ZBY2132	92	ZBY02211	97
ZBVG15	78	ZBY6H101	98	ZBY1116	100	ZBY2133	92	ZBY2212	93
ZBVG34	81	ZBY6H102	98	ZBY1146	100	ZBY02132	95	ZBY2212	97
ZBVG35	78	ZBY9W2B101	101	ZBY1147	100	ZBY2133	92	ZBY02212	97
ZBVG44	81	ZBY9W2B130	46	ZBY1148	100	ZBY02133	95	ZBY2213	93
			103	ZBY1149	100	ZBY2134	92	ZBY02213	97
ZBVG45	78	ZBY9W2B140	46	ZBY1203	100	ZBY02134	95	ZBY2214	93
ZBVG54	81		103	ZBY1204	100	ZBY2135	92	ZBY02214	97
ZBVG55	78	ZBY9W2B230	46	ZBY1207	100	ZBY02135	95	ZBY2223	93
ZBVG64	81		103	ZBY1208	100	ZBY2146	92	ZBY02223	97
ZBVG65	78	ZBY9W2B330	46	ZBY1214	100	ZBY02146	95	ZBY2226	93
			103	ZBY1303	100	ZBY2147	92	ZBY02226	97
ZBVJ1	77	ZBY9W2B430	46	ZBY1304	100	ZBY02147	95	ZBY2227	93
ZBVJ3	77		103	ZBY1311	100	ZBY2148	92	ZBY02227	97
ZBVJ4	77	ZBY9W2B630	46	ZBY1312	100	ZBY02148	95	ZBY2228	93
ZBVJ5	77		103	ZBY1316	100	ZBY2164	92	ZBY02228	97
ZBVJ6	77	ZBY9W2G101	101	ZBY1912	100	ZBY02164	95	ZBY2229	93
ZBVJ15	78	ZBY9W2G130	46	ZBY2101	92	ZBY2165	92	ZBY02229	97
ZBVJ35	78		103	ZBY2101C0	92	ZBY02165	95	ZBY2230	93
ZBVJ45	78	ZBY9W2G140	46						
			103						

ZBY02230	97	ZBY02326	96	ZBY9140T	104	ZBYFP2103C0	99	ZBYP2186C0	94
ZBY2231	93	ZBY2327	93	ZBY9160	47	ZBYFP2104	99	ZBYP2303	94
ZBY02231	97	ZBY02327	96		101	ZBYFP2104C0	99	ZBYP2303C0	94
ZBY2232	93	ZBY2328	93	ZBY9160M	105	ZBYFP2166	99	ZBYP2304	94
ZBY02232	97	ZBY02328	96	ZBY9160T	104	ZBYFP2166C0	99	ZBYP2304C0	94
ZBY2233	93	ZBY2330	93	ZBY9220	46	ZBYFP2178	99	ZBYP2367	94
ZBY02233	97	ZBY02330	96		101	ZBYFP2178C0	99	ZBYP2367C0	94
ZBY2234	93	ZBY2334	93	ZBY9230M	105	ZBYFP2186	99	ZBYP6101	98
ZBY02234	97	ZBY02334	96	ZBY9230T	104	ZBYFP2186C0	99	ZBYP6101C0	98
ZBY2235	93	ZBY2364	93	ZBY9260	47	ZBYFP2303	99	ZBZ001	76
ZBY02235	97	ZBY02364	96		101	ZBYFP2303C0	99		80
ZBY2265	93		97	ZBY9260M	105	ZBYFP2304	99	ZBZ003	107
ZBY02265	97	ZBY2366	93	ZBY9260T	104	ZBYFP2304C0	99	ZBZ006	79
ZBY2266	93	ZBY02366	96	ZBY9320	46	ZBYFP2367	99	ZBZ007	107
ZBY02266	97	ZBY2367	93		101	ZBYFP2367C0	99	ZBZ8	108
ZBY2267	93	ZBY02367	96	ZBY9330M	105	ZBYFP6101	99	ZBZ010	79
ZBY02267	97	ZBY2367C0	93	ZBY9330T	104	ZBYFP6101C0	99	ZBZ011	79
ZBY2284	93	ZBY2385	93	ZBY9360	47	ZBYLEG101000	102	ZBZ012	79
ZBY02284	97	ZBY02385	96		101	ZBYLEG101001	102	ZBZ28	47
ZBY2295	93	ZBY2387	93	ZBY9360M	105	ZBYLEG201000	102		106
ZBY02295	97	ZBY02387	96	ZBY9360T	104	ZBYLEG201001	102	ZBZ32	92
ZBY2297	93	ZBY2387	93	ZBY9420	46	ZBYLEG301000	102	ZBZ32C0	92
ZBY02297	97	ZBY02387	96		101	ZBYLEG301001	102	ZBZ33	98
ZBY2298	93	ZBY2931	92	ZBY9430M	105	ZBYLEG301001	102	ZBZ33C0	98
ZBY02298	97	ZBY02931	95	ZBY9460	47	ZBYLEG302000	102	ZBZ34	92
ZBY2299	93	ZBY4100	97		101	ZBYLEG302001	102	ZBZ35	98
ZBY02299	97	ZBY4101	92	ZBY9460M	105	ZBYLEG303000	102	ZBZ48	43
ZBY2303	93	ZBY4101C0	92	ZBY9620	46	ZBYLEG303001	102		100
ZBY02303	96	ZBY4140	92		101	ZBYLEG304000	102	ZBZ58	47
ZBY2303C0	93	ZBY5100	98	ZBY9630M	105	ZBYLEG304001	102		106
ZBY2304	92	ZBY5101	98	ZBY9660	47	ZBYLEG401000	102	ZBZ60	49
ZBY02304	95	ZBY5102	98		101	ZBYLEG401001	102		106
ZBY2304C0	92	ZBY5140	98	ZBY9660M	105	ZBYLEG402000	102	ZBZ110	79
ZBY2305	93	ZBY6101	98	ZBY9730M	105	ZBYLEG402001	102	ZBZ1600	105
ZBY02305	96	ZBY6101C0	98	ZBY9830M	105	ZBYLEG501000	102	ZBZ1602	105
ZBY2306	93	ZBY6102	98	ZBY9830M	105	ZBYLEG501001	102	ZBZ1604	105
ZBY02306	96	ZBY6102C0	98	ZBY55130	98	ZBYLEG502000	102	ZBZ1605	105
ZBY2307	93	ZBY6140	98	ZBY55330	98	ZBYLEG502001	102	ZBZ1606	105
ZBY02307	96	ZBY8101	47	ZBY22420001	93	ZBYLEG503000	102	ZBZ1902	49
ZBY2308	93		101	ZBY022420001	97	ZBYLEG503001	102	ZBZ2102	106
ZBY02308	96	ZBY8130	101	ZBYF2101	99	ZBYLEG504000	102	ZBZ3605	104
ZBY2309	93	ZBY8140	101	ZBYF2101C0	99	ZBYLEG504001	102	ZBZF32	99
ZBY02309	96	ZBY8160	47	ZBYF2103	99	ZBYM2101	94	ZBZF33	99
ZBY2310	93		101	ZBYF2103C0	99	ZBYM2103	94	ZBZG156	77
ZBY02310	96	ZBY8230	101	ZBYF2166	99	ZBYM2104	94	ZBZM156	77
ZBY2311	93	ZBY8260	47	ZBYF2166C0	99	ZBYM2166	94	ZBZVG	77
ZBY02311	96		101	ZBYF2178	99	ZBYM2178	94	ZBZVM	77
ZBY2312	93	ZBY8330	101	ZBYF2178C0	99	ZBYM2186	94	ZD4PA12	74
ZBY02312	96	ZBY8360	47	ZBYF2186	99	ZBYM2303	94	ZD4PA14	74
ZBY2313	93		101	ZBYF2186C0	99	ZBYM2304	94	ZD4PA22	74
ZBY02313	96	ZBY8430	101	ZBYF2303	99	ZBYM2367	94	ZD4PA24	74
ZBY2314	93	ZBY8460	47	ZBYF2303C0	99	ZBYM6101	98	ZD4PA103	74
ZBY02314	96		101	ZBYF2304	99	ZBYP2101	94	ZD4PA203	74
ZBY2316	93	ZBY8630	101	ZBYF2304C0	99	ZBYP2101C0	94		
ZBY02316	96	ZBY8660	47	ZBYF2367	99	ZBYP2103	94		
	97		101	ZBYF2367C0	99	ZBYP2103C0	94		
ZBY2321	93	ZBY9101	47	ZBYF4101	99	ZBYP2104	94		
ZBY02321	96		101	ZBYF4101C0	99	ZBYP2104C0	94		
ZBY2322	93	ZBY9101M	105	ZBYF6101	99	ZBYP2166	94		
ZBY02322	96	ZBY9101T	104	ZBYF6101C0	99	ZBYP2166C0	94		
ZBY2323	93	ZBY9120	46	ZBYF6102	99	ZBYP2178	94		
ZBY02323	96		101	ZBYF6102C0	99	ZBYP2178C0	94		
ZBY2326	93	ZBY9121	46	ZBYFP2101	99	ZBYP2186	94		
	97		101	ZBYFP2101C0	99				
	93	ZBY9130M	105	ZBYFP2103	99				
	96	ZBY9130T	104						
	93	ZBY9140M	105						



www.schneider-electric.com/control

Schneider Electric Industries SAS

Head Office
35, rue Joseph Monier
F-92500 Rueil-Malmaison
France

The information provided in this documentation contains general descriptions and/or technical characteristics of the performance of the products contained herein. This documentation is not intended as a substitute for and is not to be used for determining suitability or reliability of these products for specific user applications. It is the duty of any such user or integrator to perform the appropriate and complete risk analysis, evaluation and testing of the products with respect to the relevant specific application or use thereof. Neither Schneider Electric nor any of its affiliates or subsidiaries shall be responsible or liable for misuse of the information contained herein.

Design: Schneider Electric
Photos: Schneider Electric