

# NF Circuit Breaker Panelboards

Catalog  
1670CT0701

2008  
Class 1670



## CONTENTS

Description .....	Page
Standards and Ratings .....	3
Main Circuit Breakers .....	4
Branch Circuit Breakers (Bolt-on) .....	5
Interiors .....	6
Neutrals .....	9
Ground Bar Kits .....	10
Surge Protection .....	11
Enclosures .....	13
Single Row (Column-Width) Panelboards .....	16
Terminal Data .....	18
Typical Wiring Diagrams .....	19



by Schneider Electric

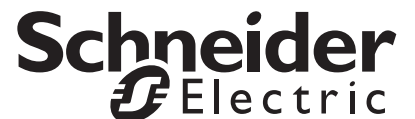



# NF Circuit Breaker Panelboards Standards and Ratings

## Standards and Ratings

NF circuit breaker panelboards are for use on ac systems. They are UL<sup>®</sup> Listed under File E33139 and marked cULus. NF circuit breaker panelboards accept EDB, EGB, and EJB branch circuit breakers.

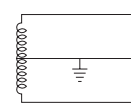
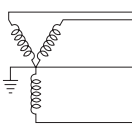
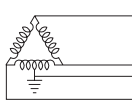
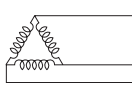
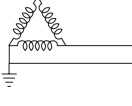
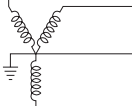
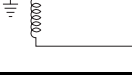
Voltage	System	System Diagram
120/240 Vac	1 $\phi$ 3W	
208Y/120 Vac	3 $\phi$ 4W	
240/120 Vac	3 $\phi$ 4W Delta	
240 Vac	3 $\phi$ 3W Delta	
240 Vac	3 $\phi$ 3W Grounded B $\phi$ Delta	
480Y/277 Vac	3 $\phi$ 4W	
600Y/347 Vac	3 $\phi$ 4W	

### Standards

NF circuit breaker panelboards are designed, manufactured, and tested to comply with the following standards:

- UL 67—Standard for Panelboards
- UL 50—Enclosures for Electrical Equipment
- UL Listed Class CTL panelboard
- CSA C22.2, No. 29-M1989—Panelboards and Enclosed Panelboards
- CSA C22.2, No. 94-M91—Special Purpose Enclosures
- NEMA PB 1—Panelboards
- NFPA 70—National Electrical Code<sup>®</sup> (NEC<sup>®</sup>)
- Federal Specification W-P-115C Type I Class 1—Circuit Breaker Panelboards
- 2003 IBC, NFPA 5000, ASCE/SE17—Seismic Qualification

### Ratings

- Main lugs: 125–800 A
- Main circuit breaker: 125–600 A

# NF Circuit Breaker Panelboards

## Main Circuit Breakers

### Main Circuit Breakers



HDL

- 125 A maximum field-installable EDB, EGB, or EJB (110 A max at 600Y/347 Vac)
- 100 A maximum field-installable FI
- 125 A maximum field-installable HDL, HGL, HJL, or HLL
- 250 A maximum field-installable JDL, JGL, JLL, or JLL
- 400 A maximum field-installable LAL or LHL
- 400 A or 600 A maximum factory-installed LCL or LIL (LCL is 480Y/277 Vac maximum)

### Factory-Installed Circuit Breaker Accessories

FIL, HDL, HGL, HJL, HLL, JDL, JGL, JLL, JLL, and KIL circuit breakers are available with shunt trip, ground fault shunt trip, undervoltage trip, time delay, auxiliary switches, and alarm switches.



JDL

**Table 1: Main Circuit Breaker Adapter Kits (Circuit Breaker Not Included)**

Adapter Kit Catalog Number	Ampere Rating	Main Circuit Breaker <sup>1</sup>
N100MFI	20–100 A	FIL
N150MH <sup>2</sup>	15–125 A <sup>3</sup>	HDL, HGL, HJL, HLL
N250MJ	150–250 A	JDL, JGL, JLL, JLL
N250MKC	110–250 A	KIL
N400M	125–400 A	LAL, LHL

<sup>1</sup> Main circuit breakers are not included in the adapter kits. Order them separately.

<sup>2</sup> For single phase applications of HDL and HGL, select a 3-pole main circuit breaker. For single-phase applications of HJL and HLL, select a 2-pole main circuit breaker.

<sup>3</sup> RTI kit accepts maximum 125 A H-frame circuit breaker.

**NOTE:** See “Main Circuit Breaker Terminal Data” on page 18.

### Field-Installable Circuit Breaker Accessories

Field-installable undervoltage release, alarm switch, shunt trip, and auxiliary contacts are available for LAL, LHL, LCL, and LIL 400 A main circuit breaker interiors.

**NOTE:** See Supplemental Digest for additional accessories.



LAL

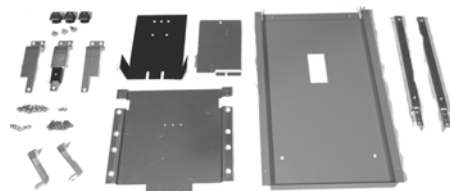

N250MJ Main Circuit Breaker Kit

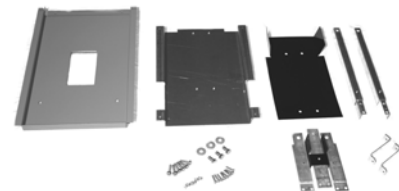

N400M Main Circuit Breaker Kit

Branch Circuit Breakers (Bolt-on)



Table 2: Standard Branches, 600Y/347 Vac Maximum

Branch Prefix	Availability			Short Circuit Current Rating <sup>1</sup>	
	1-Pole	2-Pole	3-Pole	at 480Y/277 Vac	at 600Y/347 Vac
EDB	15-70 A	15-125 A <sup>2</sup>	15-125 A <sup>2</sup>	18,000 A	14,000 A
EGB	15-70 A	15-125 A <sup>2</sup>	15-125 A <sup>2</sup>	35,000 A	18,000 A
EJB	15-70 A	15-125 A <sup>2</sup>	15-125 A <sup>2</sup>	65,000 A	25,000 A

<sup>1</sup> Series ratings are also available.  
In **Canada**: See Series Rating Guide (Data Bulletin #S1600PD0302EP).  
In **USA**: See Switchboard/Panelboard Short Circuit Current Ratings (Data Bulletin #2700DB9901) or the Digest.  
<sup>2</sup> 600Y/347 Vac is 110 A maximum.



Table 3: EPD Branches – 30 mA Ground Fault Equipment Protection Devices, 277 Vac Maximum

Branch Prefix	Availability 1-Pole <sup>1</sup>	Short Circuit Current Rating <sup>2</sup> at 277 Vac
EDB-EPD	15-70A	18,000 A
EGB-EPD	15-70A	35,000 A
EJB-EPD	15-70A	65,000 A

<sup>1</sup> EPD branches are single-pole only, and require two pole spaces in the panelboard.  
<sup>2</sup> Also available with series ratings.



Table 4: Standard and EPD Branches – Terminal Lug Data

Branch Circuit Breaker Prefix	Ampere Rating	Wire Size	
		Aluminum	Copper
EDB, EGB, EJB, EDB-EPD, EGB-EPD, EJB-EPD	15-30 A	#12 - #6	#14 - #6
	35-125 A	#12 - 2/0	#14 - 2/0

EDB Branch Circuit Breakers

# NF Circuit Breaker Panelboards Interiors

## Interiors

### Main Lug Interiors



**250 A Maximum  
Main Lugs Interior  
(Deadfronts Installed)**

- Will accept bolt-on branch circuit breakers
- Top or bottom feed
- 65,000 A Short Circuit Current Rating (SCCR) maximum branch circuit breakers at 480Y/277 Vac
- 25,000 A SCCR maximum branch circuit breakers at 600Y/347 Vac
- Series rated to 200,000 A SCCR maximum when supplied by remote I-Limiter<sup>®</sup> circuit breaker at 480Y/277 Vac
- Series rated to 65,000 A SCCR maximum when supplied by remote I-Limiter circuit breaker at 600Y/347 Vac
- 125 A and 250 A interiors are suitable for use as cULus service entrance with back-fed EDB, EGB, or EJB circuit breakers
- Factory-installed main lugs on all interiors
- 125–400 A main lug interiors are convertible to main circuit breaker interiors by adding a main circuit breaker adapter kit and a main circuit breaker
- Several bus options:
  - Silver-plated copper or tin-plated aluminum bus (aluminum is standard)
  - Tin-plated copper bus is available as an option
  - 600 A and 800 A only available with copper
- Branch connector fingers are tin-plated copper
  - Silver-plated branch connector fingers are optional
- Line lugs are suitable for 75° C copper or aluminum wire

### Factory-Installed Options for Main Lugs and Main Breaker Interiors

- Sub-Feed Lugs (on the Main)  
**NOTE:** Only available on 1 $\phi$  or 3 $\phi$ , 125–800 A main lug interiors
- Feed-Through Lugs  
**NOTE:** Available on 1 $\phi$  or 3 $\phi$ , 125–800 A main lug or 100–600 A main circuit breaker interiors
- Sub-Feed Circuit Breakers  
**NOTE:** Available on 1 $\phi$  or 3 $\phi$ , 125–800 A main lug or 100–600 A main circuit breaker interiors
  - One sub-feed HDL, HGL, HJL, HLL, JDL, JGL, JJL, or JLL circuit breaker per 250 A panelboard
  - Two sub-feed HDL, HGL, HJL, HLL, JDL, JGL, JJL, or JLL circuit breakers per 400 A panelboard
  - One sub-feed LA, LH, LC, or LI circuit breaker (400 A maximum) and one HDL, HGL, HJL, HLL, JDL, JGL, JJL, or JLL circuit breaker, or two sub-feed HDL, HGL, HJL, HLL, JDL, JGL, JJL, or JLL circuit breakers per 600 A or 800 A panelboard**NOTE:** LC/LI circuit breakers cannot be combined with JJL or JLL circuit breakers
- Split bus
- Lighting contactors
- Compression lugs

## Main Circuit Breaker Interiors



**400 A LAL  
Main Circuit  
Breaker Interior**

- Will accept bolt-on branch circuit breakers
- Suitable for use as UL service entrance (statement found on wiring label on back of deadfront); meets local electrical codes (CSA type service entrance available factory-assembled)
- Top or bottom feed
- 65 k AIR maximum branch circuit breakers at 480Y/277 Vac
- 25 K AIR maximum branch circuit breakers at 600Y/347 Vac
- Series rated to 200 k AIR maximum when supplied by remote I-Limiter circuit breaker at 480Y/277 Vac
- Series rated to 65 k AIR maximum when supplied by remote I-Limiter circuit breaker at 600Y/347 Vac
- Available with silver-plated copper or tin-plated aluminum bus (aluminum is standard). Tin-plated copper bus is available as an option; 600 A only available with copper
- Branch connector fingers are tin-plated copper; silver-plated branch connector fingers are optional
- 125 A at 480Y/277 Vac (110 A at 600Y/347 Vac) main circuit breaker interiors contain back-fed EDB, EGB, or EJB main circuit breakers
- 100–250 A main circuit breaker panelboards consist of:
  - Standard main lug interiors
  - Main circuit breaker adapter kit (N150MH, N100MFI, N250MKC, N250MJ)
  - Appropriate FIL, HDL, HGL, HJL, HLL, JDL, JGL, JLL, JLL, or KIL circuit breakers
  - Line lugs are suitable for 75° C copper or aluminum wire
- 400 A main circuit breaker panelboard consists of:
  - Standard main lug interior
  - Main circuit breaker adapter kit (N400M)
  - Appropriate LAL or LHL circuit breaker
  - Factory-installed LCL or LIL main circuit breaker with 8 in. (203 mm) deep enclosure (Type 1 only)
- 600 A main circuit breaker panelboard:
  - Factory-assembled only
  - Use LCL, LIL main circuit breakers
  - 8.75 in. (223 mm) deep enclosure (Type 1 only)

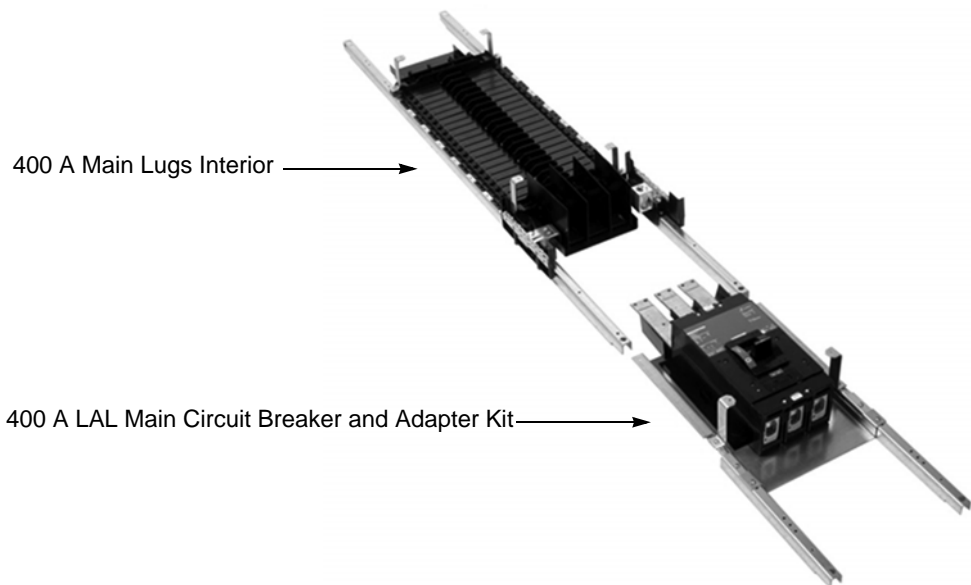

**400 A Main Lugs Interior with 400 A Main Circuit Breaker and Adapter Kit**

# NF Circuit Breaker Panelboards Interiors



**400 A Main Lug Interior with Sub-Feed Lugs**



**400 A Sub-Feed Main Lug Kits**



**Compression Lugs**

## Field-Installable Options

- Feed-Through Lug Kits
  - NF125FTL, NF250FTL, NF400FTL available for 125–400 A, 1 $\phi$  or 3 $\phi$  interiors
- Sub-Feed Circuit Breaker Kits
  - NF250SFBH allows a single sub-feed HDL, HGL, HJL, or HLL circuit breaker on 250 A interiors
  - NF250SFBJ allows a single sub-feed JDL, JGL, JJL, or JLL circuit breaker on 250 A interiors
  - NF600SFBH allows twin sub-feed HDL, HGL, HJL OR HLL circuit breaker on 400 A main lug or main circuit breaker interiors and 600A main lug interiors
  - N600SFBJ allows twin sub-feed JDL, JGL, JJL, or JLL circuit breakers on 400 A main lug or main circuit breaker interiors and 600 A main lug interiors

### Sub-Feed Lug Kits

Amperes	Catalog Number
125 A	NF125SFL
250 A	NF250SFL
400 A	NF400SFL

### 200% Neutral Kits

Amperes	Catalog Number
100 A	NFNL1
125 A	NFNL1
250 A	NFNL2
400 A	NFNL4 <sup>1</sup>

<sup>1</sup> 200% neutrals not available with FTL, SFL, or SFB.

### Copper 100% Kits

Copper 100% Amperes	Copper Neutral Kits Catalog Number
125 A	NFN1CU
250 A	NFN2CU
400 A	NFN6CU
600 A	NFN6CU <sup>1</sup>

<sup>1</sup> Not to be used with SFL, FTL, or SFB. These combinations are factory-assembled only.

## Compression Lugs

Compression lugs are available for 125–600 A main lug interiors and 100–400 A main circuit breaker interiors.



**Neutrals**

**Neutral Assembly**

- All lugs are suitable for copper or aluminum wire
- 125–250 A interiors have a split neutral located on the same end as the mains
- 400–800 A interior neutrals can be located on either end depending on the configuration
- Neutral may be bonded for use as a UL service entrance
- Branch terminals are suitable for #14-2/0 copper or aluminum and #14-#6 copper or aluminum
- Provisions for larger branch terminal lug kits are available as options
- Suitable lug provided on neutrals for termination of the grounding conductor
- All unused neutral terminals may be used to terminate equipment grounding conductors when the panelboard is used as UL service equipment
- 100% rated neutrals are standard; one neutral termination provided per circuit in the panelboard
- 200% rated neutrals are optional see, “200% Neutral Kits” below

**Neutral Bonding Provisions**

The bonding strap may be field installed for UL service equipment requirements on 125–800 A interiors. Not applicable for CSA service entrance panels in Canada.



**125–250 A Neutral Bonding Provisions**

**Table 5: Copper 100% Neutral Kits for Use with Single or Three Phase 125-600 A Interiors**

Amperage	125 A	250 A	400 A	600 A	800 A
Catalog Number	NFN1CU	NFN2CU	NFN6CU	NFN6CU <sup>1</sup>	Kit not available, Factory-assembled only

<sup>1</sup> Not to be used with SFL, FTL or SFB. These combinations are factory-assembled only.

**200% Neutral Kits**

**Table 6: 200% Neutral Kits for Use with Single or Three Phase 125-400 A Interiors**

Amperage	125 A	250 A	400 A	600 A	800 A
Catalog Number	NFNL1	NFNL2	NFNL4 <sup>1</sup>	Kit not available, Factory-assembled only	

<sup>1</sup> Not to be used with SFL, FTL or SFB. These combinations are factory-assembled only.



**NFNL2**

# NF Circuit Breaker Panelboards Ground Bar Kits



**Ground Bar Kit**

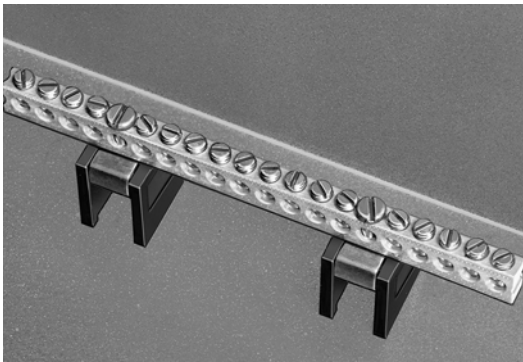

**Ground Bar with Insulator Kit**

## Ground Bar Kits

- Field installable in all panelboards
- Wire size of terminals (refer to the technical information below)

**Table 7: Ground Bar Kits**

Catalog Number	Terminals	Material
PK23GTAL	23	AL
PK27GTA	25 <sup>1</sup>	CU
PK27GTACU	27	AL

<sup>1</sup> 24 small terminals and 1 large terminal

- Order enough ground bar kits to accommodate all the ground conductors used in the panel

## Ground Bar Insulator Kits (Catalog No. PKGTAB)

- The insulator kit isolates the standard panelboard ground bar from the panelboard
- The insulator kit is field installable, and panelboard enclosures have ground bar mounting provisions in all four corners

## Technical Information

All PK equipment grounding kits are supplied with mounting screws, installation instructions, and an "Equipment Grounding Terminal" self-adhesive label.

**Table 8: Technical Information**

Catalog Number	Terminals			Approximate Overall Length Inches (mm)	Distance Between Mounting Holes Inches (mm)
	Number of Terminals	Quantity Available for Each Size			
		Material	I / II <sup>1</sup>		
PK23GTAL	24	AL	23 / 1	9.125 (232)	3.125 (79)
PK27GTA	27	AL	24 / 1	9.125 (232)	3.125 (79)
PK27GTACU	27	CU	27 / 0	9.125 (232)	3.125 (79)

<sup>1</sup> See wire range table below.

**Table 9: Wire Range**

Size	Cu	Al
I	(1) #14 to #4 or (2) #14 or #12	(1) #12 to #4 or (2) #12 or #10
II	(1) #1 to 4/0	(1) #1 to 4/0

## Surge Protection

The Surgelogic® IMA series surge protective device is a modular parallel transient voltage surge suppressor (TVSS). The IMA device is a multi-stage suppression circuit consisting of field-proven, fast-acting, 34 mm metal oxide varistors (MOVs).

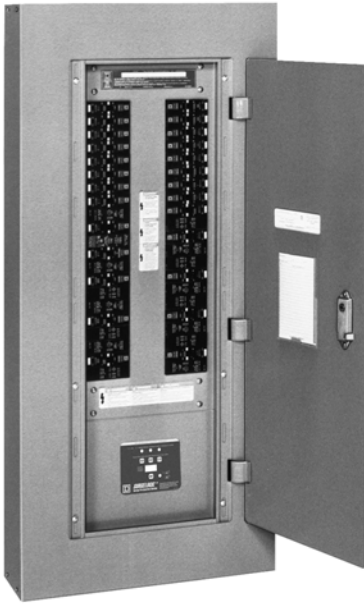

A surge suppression path is provided for each mode, line-to-neutral (L-N), line-to-line (L-L), line-to-ground (L-G), and neutral-to-ground (N-G). Each surge suppression mode is individually fused and uses circuitry with thermal cutouts to isolate the TVSS and ensure shutdown in the event of MOV damage during severe overvoltages, even when operated on high fault current power systems.

The suppression elements are encapsulated in a UL recognized potting material—another performance element that provides additional protection. A filter provides a high level of EMI/RFI noise attenuation. On-line diagnostics continuously monitor the device status, and LEDs signal loss of a suppression circuit. An audible alarm with an enable/disable feature and dry contacts are included in the standard diagnostic package.

**NF Main Lugs Panelboard with Integral TVSS**

**Table 10: NF Interiors with TVSS<sup>1</sup>**

Mains Rating	Max Circuit Breaker Spaces	TVSS Rating		Interior Catalog Number <sup>2</sup>	Components for Adding a Vertical Main Circuit Breaker	
		Voltage	Surge Rating		Main Circuit Breaker Kit	Main Circuit Breaker Frames
250 A	42	480Y/277 Vac	120	NF442L2TVS412	N150MH <sup>3</sup> N250MJ N250MKC	HD, HG, HJ or HL JD, JG, JJ or, JL KI
			160	NF442L2TVS416		
		600Y/347 Vac	120	NF442L2TVS812		
400 A	42	480Y/277 Vac	120	NF442L4TVS412	N400M	LAL/LHL (LC and LI F/A only)
			160	NF442L4TVS416		
		600Y/347 Vac	120	NF442L4TVS812		

<sup>1</sup> These interiors are available as catalog numbered devices. TVSS is not available as a field-installable kit.

<sup>2</sup> To order an interior with copper bus, add a "C" to the end of the catalog number (example: NR442L2TVS412C).

<sup>3</sup> RTI kit accepts maximum 125 A H-frame circuit breaker.

**Table 11: IMA Series Voltage Specifications**

Service Voltage	UL Suppression Voltage Rating (SVR)				
	L-N	L-G	N-G	L-L	MCOV <sup>1</sup>
120/240 Vac, 1-phase	400	400	400	800	150
208Y/120 Vac, 3-phase, 4-wire	400	400	400	800	150
240/120 Vac, 3-phase, high-leg delta	800/400	800/400	400	1500/800	275/150
480Y/277 Vac, 3-phase, 4-wire	800	800	800	1600	320
600Y/347 Vac, 3-phase, 4-wire	1200	1200	1200	2000	420

<sup>1</sup> MCOV: maximum continuous operating voltage.

# NF Circuit Breaker Panelboards

## Surge Protection

**Table 12: Performance Features**

Surge Capacity	L–N	L–G	N–G (3-Phase Rating)
100 kA / phase	50 kA	50 kA	100 kA
120 kA / phase	60 kA	60 kA	120 kA
200 kA / phase	100 kA	100 kA	200 kA
160 kA / phase	80 kA	80 kA	120 kA
240 kA / phase	120 kA	120 kA	120 kA

**Table 13: Specifications**

Relative Humidity	0 to 95% non-condensing
Operating Frequency	47–63 Hz
Storage Temperature	-40 to +65 °C (-40 to +149 °F)
Operating Temperature	-40 to +65 °C (-40 to +149 °F)
Display Operating Temperature	-10 to +50 °C (+14 to +122 °F)
Standards	C-UL, UL 1449 Second Edition UL Category Section 37.3 (200 kA short-circuit current module rating)
Fusing	Individually fused suppression modules
Audible Alarm	Provides audible indication that there is a loss of protection
Dry Contacts	Provides remote indication of the TVSS device's operating status to a computer interface board or emergency management system

**Table 14: Other Options**

Option	Description
Surge Counter	Displays the combined total number of transient voltage surges detected from L–G, L–L, L–N, and N–G since the counter was last reset.
Remote Monitor	Displays the alarm status of the surge protective device up to 1,000 ft. (305 m) away from the unit. This option uses the dry contacts.

### Design Features

- Individually fused suppression modules
- Thermal cutout
- Inline, copper bus bar connection
- Solid state bi-directional
- Push-to-Test on-line diagnostic display
- Audible alarm with enable/disable switch
- LED indicators indicate loss of protection, or fully operational circuit
- High-energy parallel design for IEEE C62.41 category A, B, and C3 applications
- Available in main circuit breaker and main lug only panelboards with sub-feed circuit breakers, feed-through lugs, or sub-feed lugs
- AC tracking filter with EMI/RFI filtering up to -50 dB from 100 kHz to 100 MHz

Enclosures

Enclosure Types



**Mono-Flat Type 1  
Enclosure for  
100–250 A Interiors**

Type	Environment	Protects Against
Type 1	Indoor	Contact with the enclosed equipment, falling dirt
Type 2	Indoor	Type 1, plus • Dripping and light splashing of non-corrosive liquids
Type 3R	Outdoor	Type 2, plus • Rain, snow, and sleet
Type 4	Indoor/outdoor	Type 3R, plus • Circulating dust, lint, fibers and flyings • Settling airborne dust, lint, fibers and flyings • Windblown dust • Hosedown and splashing water
Type 4X	Indoor/outdoor	Type 4, plus • Corrosive agents
Type 5	Indoor	Type 2, plus • Settling airborne dust, lint, fibers, and flyings
Type 12	Indoor	Type 2, plus • Circulating dust, lint, fibers, and flyings • Settling airborne dust, lint, fibers, and flyings • Oil and coolant seepage

Indoor Enclosures (Types 1 and 2)



**Type 1 Enclosure for  
400–800 A Interiors**

MH type Box

- Standard boxes are 20 in. (508 mm) wide by 5.75 in. (223 mm) deep
  - NF interiors with an LC or LI main circuit breaker or with an 800 A MLO interior require an 8.75 in. (223 mm) deep box — therefore, they are available factory-assembled and fully-assembled only
  - Boxes are galvanized steel with removable endwalls. On standard 5 3/4 inch depth boxes, one endwall is provided with knockouts, and the other endwall is blank. On deeper boxes, both are blank. Endwalls are removable and interchangeable
  - Box and interior mounting instructions are included in the documentation shipped with the interior
  - Keyhole slots are located in the box backwall to ease installation
- NOTE:** Interiors mount directly to studs in MH boxes. No interior mounting brackets are required.
- NOTE:** 800 A interiors and interiors that have LC/LI main circuit breakers require elevating brackets, due to the requirement of an 8.75 in. (223 mm) deep box.
- Type 2 boxes include a drip hood (available with surface mounted trim only)

## NF Circuit Breaker Panelboards Enclosures

### Type 1 and 2 Trim Fronts

- Finished with gray-baked enamel electrodeposited over cleaned, phosphatized steel (ANSI 49)
- Order flush or surface mounted
- Door with flush lock; uses NSR-251 key
- Directory card located on the inside of the door
- Mono-Flat® fronts on 100–250 A interiors mount to the interior trim with trim screws. Both trim mounting screws and door hinges are concealed; fronts are not removable with the door closed and locked
- Fronts for 400–800 A interiors are ventilated and mount to the enclosure with trim screws; door hinges are concealed
- Fronts 56 in. (1422 mm) high or more on 250 A interiors or 74 in. (1880 mm) high or more on 600 A and 800 A interiors have two flush locks
- Fronts 68 in. (1727 mm) high or more on interiors with LC/LI main circuit breakers or LC sub-feed circuit breakers use a sliding vault lock with 3-point latching



**Key NSR-251**  
(Catalog No. LP9618)



**Concealed Hinge for 100–800 A Trim Fronts**



**Interiors Mount Directly to Enclosure Studs**



**Standard Flush Lock**  
(Catalog No. PK4FL)



**Optional Sliding Vault Lock (Catalog No. PK5FL)**



**MH Box**

## NF Circuit Breaker Panelboards Enclosures

### Rainproof (Type 3R) Dust tight (Type 5 and 12)



- Finished with gray-baked enamel electrodeposited over cleaned, phosphatized galvanized steel (ANSI 49)
- Gasketed door with lockable vault handle (PK4NVL); uses NSR-251 key
- Directory card located on the inside of the door
- No knockouts in endwalls
- Trim kit included for end and side gutters
- Provisions for two ground bars
- 125 A, 250 A, 400 A main lug and main circuit breaker interiors
- 600 A and 800 A main lug only



Type 3R, 5, and 12 Enclosures



Vault Handle with Lock  
(Catalog No. PK4NLV)



Type 4X Enclosure

### Corrosion-Resistant Fiberglass-Reinforced Polyester (Type 4X)

- Watertight and dust-tight
- Gasketed door with trunk latches
- Directory card located on the inside of the door

### Stainless Steel (Type 4 and 4x)

- Water and dust tight
- Gasketed door
- Directory card located on inside of door

# NF Circuit Breaker Panelboards

## Single Row (Column-Width) Panelboards

### Single Row (Column-Width) Panelboards

#### Application Data



Column-Width Panelboard

#### Ratings

- Main lugs: 125 A, 225 A
- Main circuit breaker: 100 A, 225 A

#### Interiors

- 60 A maximum branch circuit breaker
- Bolt-on EDB/EGB/EJB circuit breakers
- Solid neutral opposite mains

#### Enclosures

- 8-5/8 in. (219 mm) wide by 5-5/8 in. (143 mm) deep for 10 in. (254 mm) H- or I-beam
- Galvanized steel
- Removable endwalls

#### Trim Fronts

- Screw mounted
- Door with two flush latches
- Finish: gray-baked enamel electrodeposited over cleaned, phosphatized steel

#### Line Lugs

- All lugs are suitable for 75° C copper or aluminum wire

**Table 15: Branch Circuit Breaker Short-Circuit Current Ratings**

Branch Breaker Prefix 1, 2 and 3 pole 15 to 60A	Short Circuit Current Rating <sup>1</sup>	
	@ 480Y/277 Vac	@ 600Y/347 Vac
EDB	18,000 A	14,000 A
EGB	35,000 A	18,000 A
EJB	65,000 A	25,000 A

<sup>1</sup> Series ratings are also available.

**Canada:** See the Series Rating Guide (data bulletin S1600PD0302EP R\_\_).

**USA:** See Switchboard/Panelboard Short-Circuit Ratings (data bulletin 2700DB9901), or the Digest (<http://ecatalog.squared.com/category.cfm>).



# NF Circuit Breaker Panelboards Single Row (Column-Width) Panelboards

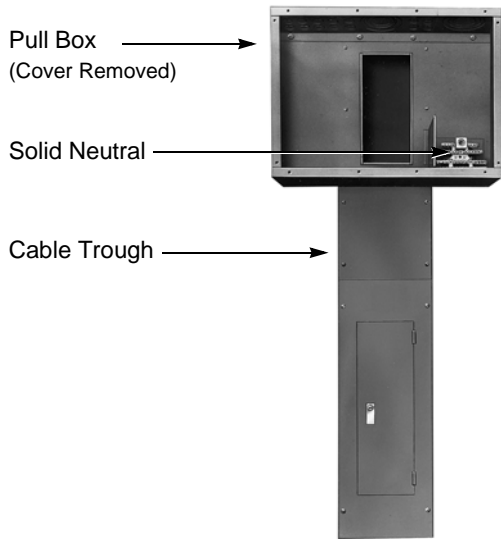

**Single Row (Column-Width) Panelboard**

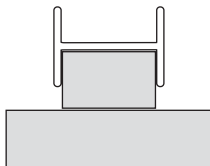

**Cable Trough Top View with I-Beam**

## Cable Trough

- Cable trough is stackable
- 8-5/8 in. (219 mm) wide by 5-5/8 in. (143 mm) deep for 10 in. (254 mm) I-beam or H-beam
- Galvanized steel trough uses enclosure endwall
- Screw-mounted two-piece front
  - 15 in. (381 mm) long top piece of front removable for pull box mounting
  - Finish: gray-baked enamel electrodeposited over cleaned, phosphatized steel

**Table 16: Column-Width Cable Trough**

Length of Cable Trough	Catalog No.
36 in. (914 mm)	NTX836
48 in. (1219 mm)	NTX848
56 in. (1422 mm)	NTX856
66 in. (1676 mm)	NTX866
84 in. (2134 mm)	NTX884
96 in. (2438 mm)	NTX896
104 in. (2642 mm)	NTX8104
112 in. (2845 mm)	NTX8112

## Pull Box

(catalog number MPX81542)

- Mounts on cable trough
- 20 in. (508 mm) wide by 5-3/4 in. (146 mm) deep by 15 in. (381 mm) high
- Screw-mounted front
- Finish: gray-baked enamel electrodeposited over cleaned, phosphatized steel
- Removable top endwall with knockouts
- Solid neutral included

# NF Circuit Breaker Panelboards Terminal Data

## Terminal Data

### Main Lugs Terminal Data

**Table 17: Standard Aluminum and Copper Lugs**

Amperes	Aluminum				Copper			
	Aluminum Mechanical		Aluminum Compression		Copper Mechanical		Copper Compression	
	Cat. #	Lug Wire Range	Cat. #	Lug Wire Range	Cat. #	Lug Wire Range	Cat. #	Lug Wire Range
125	NFALM1	(1) #6 - 2/0 <sup>1</sup>	NFALV1	(1) #4-300 kcmil	NFCUM1	(1) #6 - 350 kcmil	NFCUV1	(1) #6 - 1/0
250	NFAML2	(1) #6 - 350 kcmil	NFALV2	(1) 250-350 kcmil	NFCUM2	(1) #6 - 350 kcmil	NFCUV2	(1) 2/0 - 300 kcmil
400	NFALM4	(1) 1/0-750 kcmil or (2) 1/0-350 kcmil	NFALV4	(2) 2/0-500 kcmil	NFCUM4	(1) 1/0-750 kcmil or (2) 1/0-350 kcmil	NFCUV4	(1) 400-750 kcmil
600	NFALM6	(2) 1/0-600 kcmil	NFALV6	(2) 2/0-500 kcmil	NFCUM6	(2) 1/0-750 kcmil	NFCUV6	(2) 250-750 kcmil
800	Contact the Technical Applications Group (TAG)							

<sup>1</sup> Neutral accepts #6-2/0 Al/Cu.

### Main Circuit Breaker Terminal Data

See Digest section 7 for copper lugs.

**Table 18: Standard Aluminum Mechanical Lugs**

Panelboard Type	Ampere Rating	Circuit Breaker Type	Lug Wire Range
NF	100 A	FIL	(1) #14-1/0 Cu or (1) #12-1/0 Al
	125 A <sup>1</sup>	EDB, EGB, EJB	(1) #14-2/0 Al/Cu
	150 A	HDL, HGL, HJL, HLL	(1) #14-3/0 Al/Cu
	250 A	JDL, JGL, JJL, JLL, KI	(1) 3/0-350 kcmil Al/Cu
	400 A	LAL, LHL	(1) #1-600 kcmil Al/Cu or (2) #1-250 kcmil Al/Cu
	600 A	LCL, LIL, LEL, LXL LXIL	(2) 4/0-500 kcmil Al/Cu
	800 A	800 A main breaker panelboard not available.	

<sup>1</sup> 110 A maximum at 600Y/347 Vac.

**Table 19: Aluminum Compression Lugs**

Panelboard Type	Ampere Rating	Circuit Breaker Type	Catalog No.	Lug Wire Range
NF	100 A	FC, FI	VC100FA	(1) #8-1/0 Al/Cu
	125 A <sup>1</sup>	ED, EG, EJ	VC100FD	(1) #8-1/0 Al/Cu
	150 A	HDL, HGL, HJL, HLL	YA150HD	(1) #1-4/0 Al/Cu
	250 A	JDL, JGL, JJL, JLL	YA250J35	(1) 3/0-350 kcmil Al/Cu
	250 A	KI	VC250KA3	(1) #4-300 kcmil Al/Cu
	400 A	LA, LH	VC400LA5 <sup>2</sup>	(1) 2/0-500 kcmil Al/Cu
	600 A	LC, LI, LE, LX, LXI	—	—
	800 A	800 A main breaker panelboard not available.		

<sup>1</sup> 110 A maximum at 600Y/347 Vac.

<sup>2</sup> Other lug sizes available.

Typical Wiring Diagrams

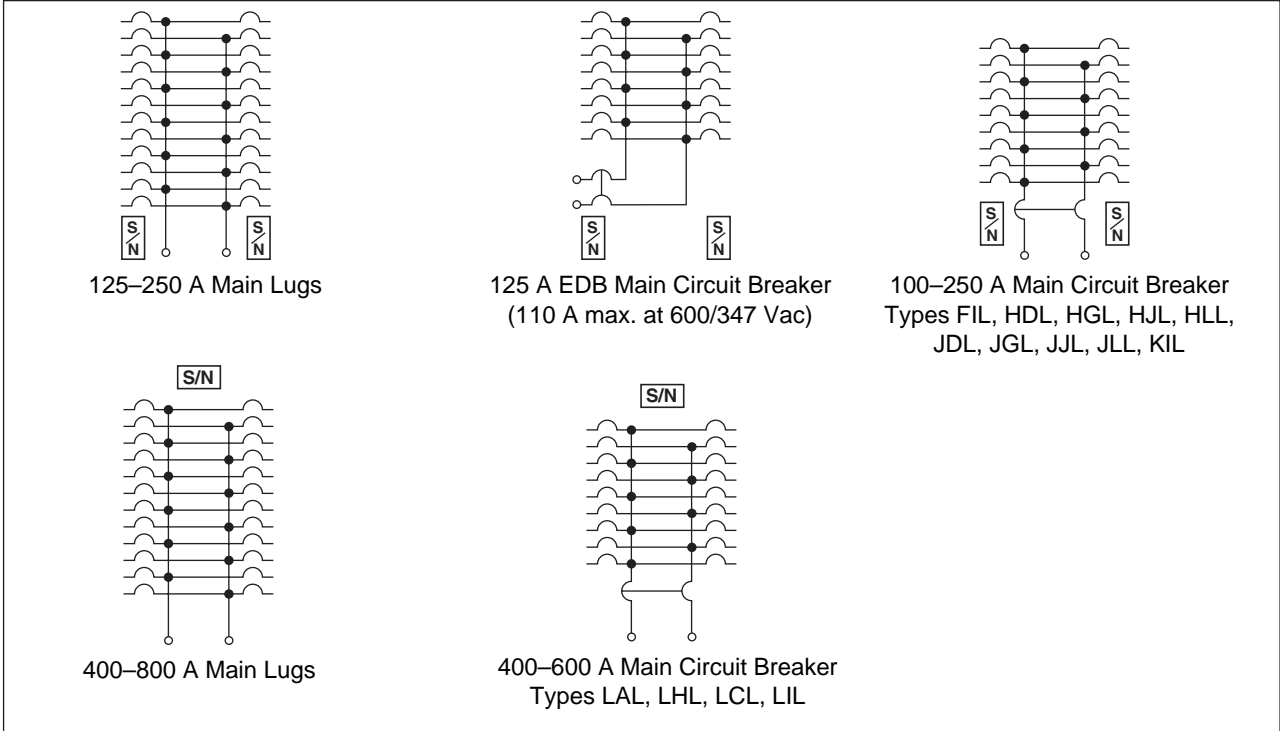

1-Phase, 3-Wire

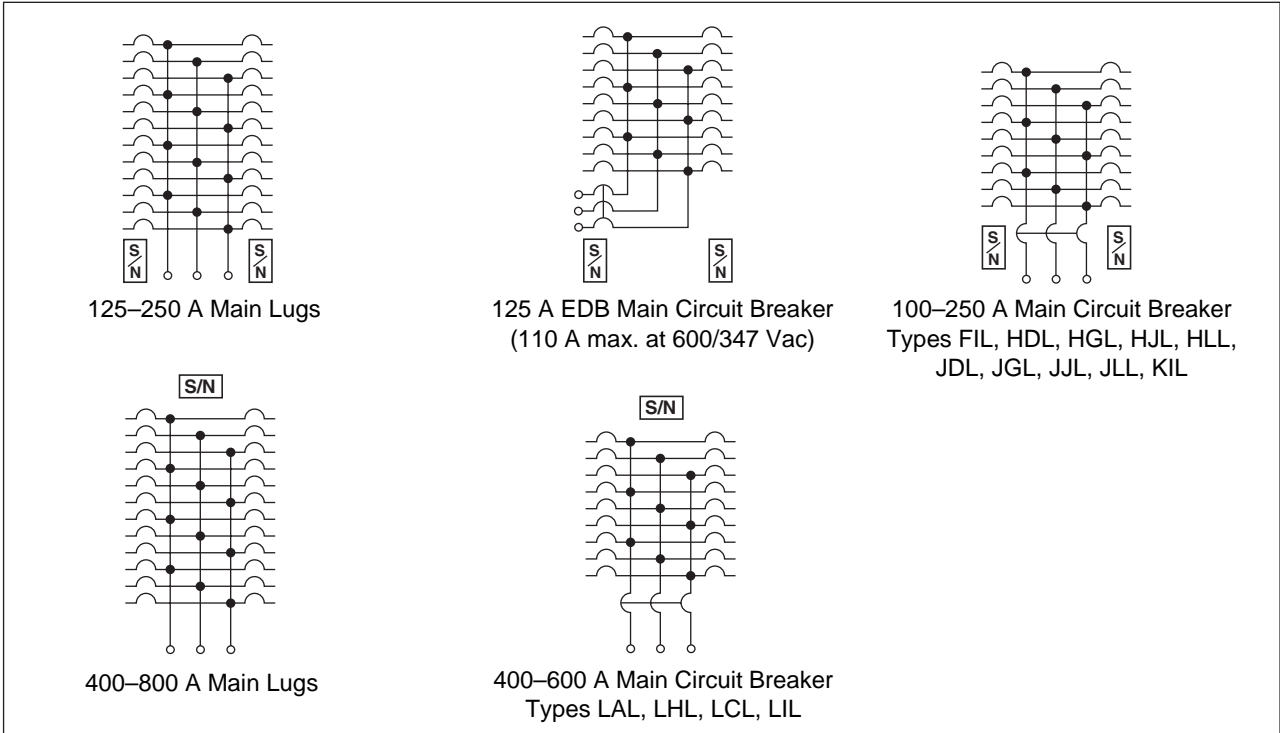

3-Phase, 4-Wire





**Schneider Electric USA**

252 North Tippecanoe  
Peru, IN 46970 USA  
1-888-SquareD  
(1-888-778-2733)  
[www.us.SquareD.com](http://www.us.SquareD.com)

**Schneider Electric Canada**

19 Waterman Avenue,  
M4B 1 Y2  
Toronto, Ontario  
1-800-565-6699  
[www.schneider-electric.ca](http://www.schneider-electric.ca)

"Surgelocic", "Mono-Flat", and "I-Limiter" are trademarks or registered trademarks of Schneider Electric and/or its affiliates in the United States and/or other countries. Other marks used herein may be the property of their respective owners.

1670CT0701 © 2008 Schneider Electric All Rights Reserved  
Replaces 1670CT0701 dated 03/2008