

Zelio[®] Logic 2

Programmable Smart Relays

Catalog
January

07



Modbus[®], Telemecanique[®], Zelio[®], Twido[®], and Phaseo[®] are registered trademarks of Schneider Electric. Other trademarks used herein are the property of their respective owners.

Zelio[®] Logic 2 Programmable Smart Relays

Selection guide *pages 4 to 7*

Compact and modular smart relays

- Presentation *pages 8 and 9*
- Description *page 10*
- Functions *pages 11 to 13*
- Characteristics *pages 14 to 17*
- Curves *pages 18 and 19*
- References *pages 20 to 22*
- Dimensions, mounting *page 23*
- Schemes *pages 24 to 27*

Modbus[®] network slave communication module

- Presentation *page 28*
- Description, characteristics *page 29*
- Functions *page 30*
- References, dimensions, mounting *page 31*

Modem communication interface

- Presentation, description *pages 32 and 33*
- Functions *pages 34 and 35*
- Setting-up *page 36*
- Characteristics *page 37*
- References *page 38*
- Dimensions *page 39*
- Connections *pages 40 and 41*

Power supplies

- Presentation *page 42*
- Characteristics, selection *pages 43 and 44*
- References, dimensions, mounting *page 45*

Zelio[®] Logic 2

Programmable Smart Relays

Compact and modular smart relays

Smart relay type	Compact smart relays			
				
Supply voltage	⎓ 12 V	⎓ 24 V	~ 24 V	~ 100...240 V
Number of I/O (maximum number of I/Os with extension modules)	12 and 20	10, 12 and 20	12 and 20	10, 12 and 20
Number of discrete inputs (including analog inputs)	8 (4) and 12 (6)	6 (0), 8 (4), 12 (2) and 12 (6)	8 (0) and 12 (0)	6 (0), 8 (0) and 12 (0)
Number of “relay”/“transistor” outputs	4/0 and 8/0	4/0, 0/4, 8/0 and 0/8	4/0 and 8/0	
With display, with clock Programming language	SR2 B●●●●● FBD or LADDER			
With display, without clock Programming language	SR2 A●●●●● LADDER only		SR2 A●●●●● LADDER only	
Without display, with clock Programming language	SR2 E●●●●● FBD or LADDER			
Without display, without clock Programming language	SR2 D●●●●● LADDER only		SR2 D●●●●● LADDER only	
Analog I/O extension modules (see page 21)				
Modbus [®] network slave communication module (see page 31)				
Modem communication interface (see page 38)	SR2 COM01	SR2 COM01 (for SR2 B and SR2 E)	SR2 COM01	SR2 COM01 (for SR2 B and SR2 E)
EEPROM memory cartridge (see page 22)	SR2 MEM02 ⚠ incompatible with SR2 COM01			
“Zelio Soft 2” software (see page 22)	SR2 SFT01			
“Discovery” packs	SR2 PACK●BD (see page 20)		SR2 PACK●FU (see page 20)	
Power supplies for d.c. control circuit (see page 45)	ABL 7RM1202	ABL 7RM240●●		
References	SR2 B●●●JD	SR2 ●●●●BD	SR2 ●●●●B	SR2 ●●●●FU
Page	20	20	20	20

(1) FBD: Function Block Diagram.

Modular smart relays



☰ 12 V

☰ 24 V

~ 24 V

~ 100...240 V

26 (30, 32, 36 and 40)

10 (14, 16, 20 and 24) and 26 (30, 32, 36 and 40)

16 (6)

6 (4) and 16 (6)

6 (0) and 16 (0)

10/0

4/0, 0/4, 10/0 and 0/10

4/0 and 10/0

SR3 B●●●●●
FBD or LADDER

SR3 XT43BD

SR3 MBU01BD

SR2 COM01

SR3 PACK●BD
(see page 21)

SR3 PACK●FU
(see page 21)

ABL 7RM1202

ABL 7RM240●●

SR3 B261JD

SR3 B●●●BD

SR3 B●●1B

SR3 B●●1FU

21

21

21

21

(1) FBD: Function Block Diagram.

Zelio® Logic 2

Programmable Smart Relays

Extensions and interfaces

Product types

Discrete I/O extension modules



Supply voltage

via SR3 B261JD (— 12 V) via SR3 B●●●BD (— 24 V) via SR3 B●●1B (~ 24 V) via SR3 B●●1FU (~ 100...240 V)

Number and type of I/O

Discrete inputs/outputs: 6, 10 and 14

Number and type of inputs

Discrete inputs: 4, 6 and 8

Number and type of outputs

Relay outputs: 2, 4 and 6

Programming software

"Zelio Soft 2" SR2 SFT01 (see page 22)

Alarms management software

References

SR3 XT●●●JD SR3 XT●●●BD SR3 XT●●●B SR3 XT●●●FU

Page

21 21 21 21

Analog I/O extension modules



via SR3 B●●●BD
(= 24 V)

Analog inputs/outputs: 2/2

Analog inputs: 2

0-10 V	0-20 V	Pt100
2	0	0
1	1	0
0	2	0
1	0	1
0	1	1

Analog outputs 0-10 V: 2

Modbus® network slave communication module



via SR3 B●●●BD
(= 24 V)

- Number of words:
 - 4 (inputs)
 - 4 (outputs)
 - 1 (status)
- Maximum number of slaves: 32
- Maximum number of slaves with repeaters: 247

Modbus® communication interface



= 12 to 24 V

- Functions
- alarm sending
 - receipt of instruction
 - remote dialogue with Zelio Soft 2 software:
 - Transfer
 - Monitoring
 - Diagnostics
- 2 types of modem:
- analog (PSTN) modem
 - GSM modem

Power supplies for d.c. control circuit



~ 100...240 V single-phase

- Nominal output voltage.:
- = 12 V
 - = 24 V
- Nominal output current:
- 1.9 A (= 12 V)
 - 1.3 A (= 24 V)
 - 2.5 A (= 24 V)

"Zelio Logic Alarm" SR2 SFT02
(see page 38)

SR3 XT43BD

21

SR3 MBU01BD

31

SR2 COM01

38

ABL 7RM●●●●●

45

Zelio[®] Logic 2

Programmable Smart Relays

Compact and modular smart relays

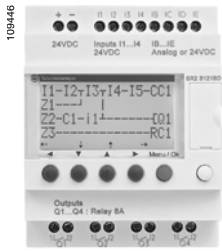

SR2 B121BD

Modular smart relay and extension module combination



- 1 Modular smart relay (10 or 26 I/O)
- 2 Discrete I/O (6, 10 or 14 I/O) or analog I/O (4 I/O) extension module

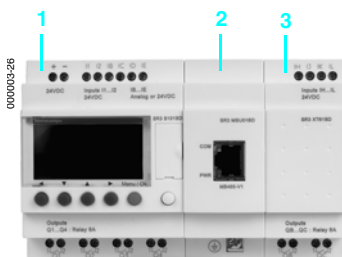

- 1 Modular smart relay (10 or 26 I/O)
- 2 Network communication module
- 3 Discrete I/O (6, 10 or 14 I/O) or analog I/O (4 I/O) extension module

⚠ The order shown above must be observed when using a Modbus network slave communication module and a discrete or analog I/O extension module. An I/O extension module cannot be fitted before the Modbus network slave communication module.

Presentation

Zelio Logic 2 programmable smart relays are designed for use in small automation systems. They are used in both the industrial and commercial sectors.

■ For industry:

- automation of small finishing, production, assembly or packaging machines.
- decentralized automation of ancillary equipment of large and medium-sized machines (textile, plastics, materials processing sectors, etc.)
- automation systems for agricultural machinery (irrigation, pumping, greenhouses, etc.).

■ For the commercial/building sectors:

- automation of barriers, roller shutters, access control,
- automation of lighting systems,
- automation of compressors and air conditioning systems.

Their compact size and ease of setting-up make them a competitive alternative to solutions based on cabled logic or specific cards.

■ Programming

Simple programming, ensured by the universal nature of the languages, meets all the requirements of automation specialists and also the needs of the electrician.

Programming can be performed:

- independently, using the buttons on the smart relay (ladder language),
- on a PC using “Zelio Soft 2” software.

When using a PC, programming can be performed either in LADDER language or in function block diagram (FBD) language, see pages 12 and 13.

Backlighting of the LCD display (1) is set by either using the 6 programming buttons on the smart relay or by using “Zelio Soft 2” software (example: flashing in the event of a malfunction).

The autonomous operating time of the clock, assured by a lithium battery, is 10 years.

Data backup (preset values and current values) is provided by an EEPROM Flash memory (10 years).

Compact smart relays

Compact smart relays meet requirements for simple automation systems.

The number of inputs/outputs can be:

- 12 or 20 I/O, supplied with $\approx 12\text{ V}$ or $\sim 24\text{ V}$,
- 10, 12 or 20 I/O, supplied with $\approx 24\text{ V}$ or $\sim 100\dots 240\text{ V}$.

Modular smart relays and extensions

The number of inputs/outputs for modular smart relays can be:

- 26 I/O, supplied with $\approx 12\text{ V}$,
- 10 or 26 I/O, supplied with $\approx 24\text{ V}$, $\sim 24\text{ V}$ or ~ 100 to 240 V .

To improve performance and flexibility, Zelio Logic 2 modular smart relays can be fitted with I/O extension modules with from 10 to 40 I/O:

- discrete I/O extension modules with 6, 10 or 14 I/O, supplied via the smart relay at the same voltage,
- analog I/O extension modules with 4 I/O, supplied with $\approx 24\text{ V}$ via the smart relay at the same voltage,
- network communication module, supplied with $\approx 24\text{ V}$ via the smart relay at the same voltage.

(1) LCD: Liquid Crystal Display.

Zelio® Logic 2

Programmable Smart Relays

Compact and modular smart relays



SR2 MEM01
SR2 MEM02

Memory cartridges

The Zelio Logic 2 programmable smart relays can be fitted with a backup memory cartridge which enables copying of the program into another smart relay for: loading and updating of on-board software and firmware (1), building of identical equipment, remote transmission of updates.

These memory cartridges also enable a backup copy of the program to be saved prior to replacing the product.

When they are used with a smart relay without display or buttons, the copy of the program contained in the cartridge is automatically transferred into the smart relay on power-up.



SR2 COM01
Communication interface

Modem communication interface

The "communication" products in the Zelio Logic 2 range include:

- a Modem communication interface connected between a smart relay and a Modem, see pages 32 to 41,
- analog (PSTN) (2) or GSM (3) Modems,
- "Zelio Logic Alarm" software.

They are designed for monitoring or remote control of machines or installations which operate without personnel.

The Modem communication interface supplied with \approx 12 to 24 V, enables messages, telephone numbers and calling conditions to be stored.

(1) Use memory cartridge SR2 MEM02 only for software and firmware versions V3.0 or higher.
Use SR2 MEM01 for any software versions earlier than V3.0 of the Zelio Logic 2 software.

The SR2 MEM01 cannot update firmware of any version.

(2) Public Subscriber Telephone Network.

(3) Global System Mobile.

Zelio® Logic 2

Programmable Smart Relays

Compact and modular smart relays

Compact smart relays

With display - 10, 12 and 20 I/O

Without display - 10, 12 and 20 I/O

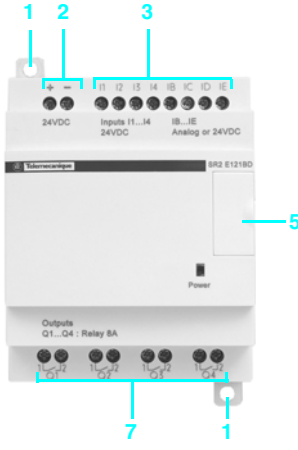
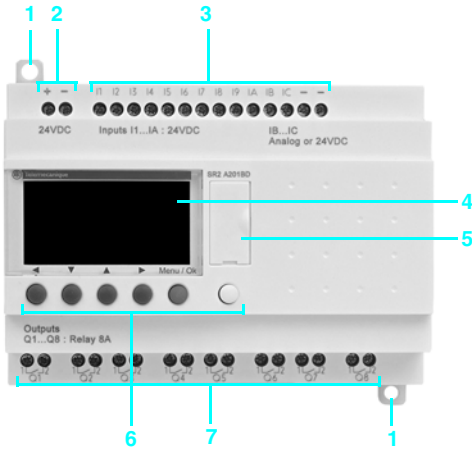

Compact smart relays have the following on the front face:

- 1 Two retractable mounting feet.
- 2 Two power supply terminals.
- 3 Terminals for connection of the inputs.
- 4 Backlit LCD display with 4 lines of 18 characters.
- 5 Slot for memory cartridge or connection to a PC or communication interface.
- 6 6 buttons for programming and parameter entry.
- 7 Terminals for connection of the outputs.

Modular smart relays

With display - 10 and 26 I/O

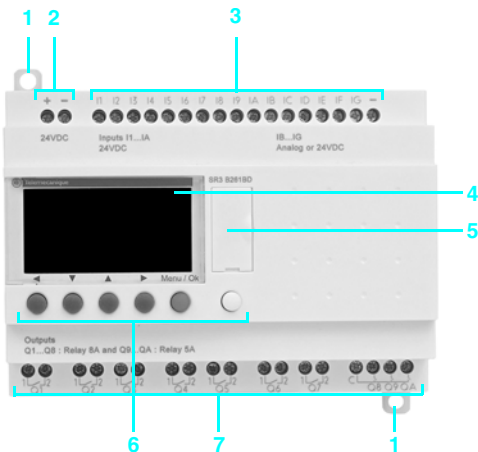

Modular smart relays have the following on the front panel:

- 1 Two retractable mounting feet.
- 2 Two power supply terminals.
- 3 Terminals for connection of the inputs.
- 4 Backlit LCD display with 4 lines of 18 characters.
- 5 Slot for memory cartridge or connection to a PC or communication interface.
- 6 6 buttons for programming and parameter entry.
- 7 Terminals for connection of the outputs.

Discrete and analog I/O extension modules

6 discrete I/O

10 and 14 discrete I/O

4 analog I/O

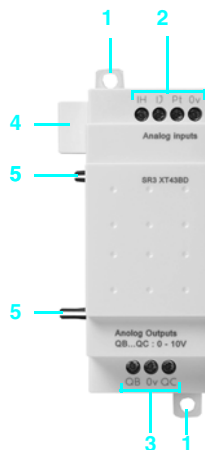
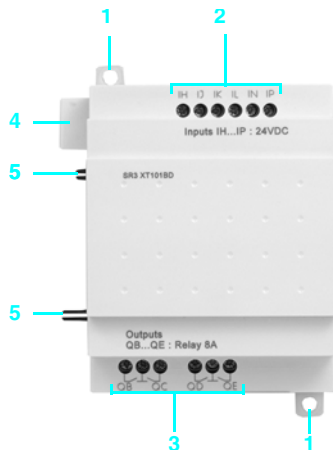
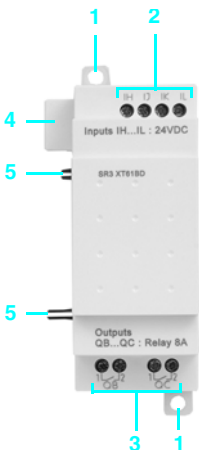

I/O extension modules have the following on the front face:

- 1 Two retractable mounting feet.
- 2 Terminals for connection of the inputs.
- 3 Terminals for connection of the outputs.
- 4 A connector for connection to the smart relay (powered by the smart relay).
- 5 Locating pegs.

Zelio® Logic 2 Programmable Smart Relays

Compact and modular smart relays
“Zelio Soft 2” programming software

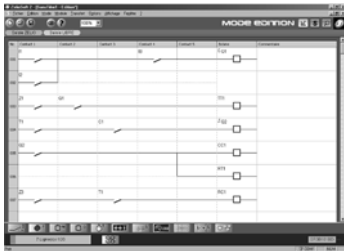

Programming in LADDER language

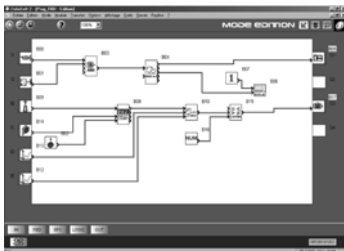

Programming in FBD language

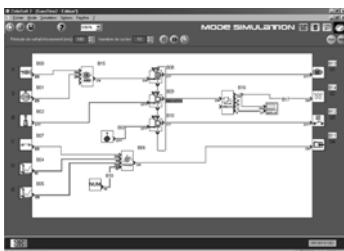

“Simulation” mode in FBD language

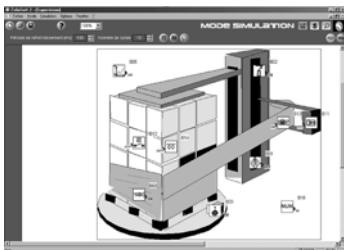

“Monitoring” window

“Zelio Soft 2” for PC (versions 3.1 and above)

“Zelio Soft 2” software enables:

- programming in LADDER language or in function block diagram (FBD) language, see pages 12 and 13.
- simulation, monitoring and supervision,
- uploading and downloading of programs,
- output of personalized files,
- automatic compiling of programs,
- on-line help.

Coherence tests and application languages

“Zelio Soft 2” software monitors applications by means of its coherence test function. An indicator turns red at the slightest input error. The problem can be located by simply clicking the mouse.

“Zelio Soft 2” software allows switching, at any time, to any of the 6 languages (English, French, German, Spanish, Italian, Portuguese) and editing of the application file in the selected language.

Inputting messages for display on Zelio Logic 2 programmable smart relays

“Zelio Soft 2” software allows Text function blocks to be configured, which can then be displayed on all smart relays which have a display.

Program testing

2 test modes are provided:

- “Zelio Soft 2” **simulation** mode allows a program to be tested without a Zelio Logic 2 programmable smart relay, i.e.:
 - enable discrete inputs,
 - display the status of outputs,
 - vary the voltage of the analog inputs,
 - enable the programming buttons,
 - simulate the application program in real time or in accelerated time,
 - dynamically display (in red) the various active elements of the program.
- “Zelio Soft 2” **monitoring** mode makes it possible to test the program executed by the smart relay, i.e.:
 - display the program “on-line”,
 - force inputs, outputs, control relays and current values of the function blocks,
 - adjust the time,
 - change from STOP mode to RUN mode and vice versa.

In simulation or monitoring mode, the monitoring window allows the status of the smart relay I/Os to be displayed within your application environment (diagram or image).

Zelio[®] Logic 2 Programmable Smart Relays

Compact and modular smart relays
“Zelio Soft 2” programming software

LADDER language

Definition



Text function block



Timer

LADDER language enables a LADDER program to be written with elementary functions, elementary function blocks and derived function blocks, as well as with contacts, coils and variables.

The contacts, coils and variables can be annotated. Text can be placed freely within the graphic.



Up/down counter



Fast counter

■ Control scheme input modes

“Zelio input” mode enables users who have directly programmed the Zelio Logic 2 programmable smart relay to find the same user interface, even when using the software for the first time.

“Free input” mode, which is more intuitive, is very user-friendly and incorporates many additional features.

With LADDER programming language, two alternative types of symbol can be used :

- LADDER symbols,
- electrical symbols.

“Free input” mode also allows the creation of mnemonics and notes associated with each line of the program.

Instant switching from one input mode to the other is possible at any time, by simply clicking the mouse.

Up to 120 control scheme lines can be programmed, with 5 contacts and 1 coil per program line



Analog comparator



Clock



Control relay



Counter comparator

■ Functions:

- 16 time delay function blocks; parameters of 11 different types can be set for each of these (1/10th second to 9999 hours),
- 16 up/down counter function blocks from 0 to 32767,
- 1 fast counter (1 kHz),
- 16 Text function blocks,
- 16 analog comparator function blocks,
- 8 clock function blocks, each with 4 channels,
- 28 control relays,
- 8 counter comparators,
- automatic Summer/Winter time switching,
- variety of functions: coil, latching (Set/Reset), impulse relay, contactor,
- LCD screen with programmable backlighting,
- 28 message blocks (with communication interface, see page 32).



LCD backlighting



Summer/Winter time switching



Output coil



Message

Functions

Function	Electrical scheme	LADDER language	Notes
Contact			I corresponds to the real state of the contact connected to the input of the smart relay. i corresponds to the inverse state of the contact connected to the input of the smart relay.
Standard coil			The coil is energized when the contacts to which it is connected are closed.
Latch coil (Set)			The coil is energized when the contacts to which it is connected are closed. It remains tripped when the contacts re-open.
Unlatch coil (Reset)			The coil is de-energized when the contacts to which it is connected are closed. It remains inactive when the contacts re-open.

Zelio® Logic 2

Programmable Smart Relays

Compact and modular smart relays
“Zelio Soft 2” programming software

Function block diagram language (FBD) (1)





































Definition

FBD language allows graphical programming based on the use of predefined function blocks.

This language provides the use of 24 pre-programmed functions for counting, time delay, timing, definition of switching threshold (example: temperature regulation), generation of impulses, time programming, multiplexing, display, etc.

Pre-programmed functions

Zelio Logic 2 programmable smart relays provide a high processing capacity, up to 200 function blocks, including 24 pre-programmed functions:

 <p>TIMER AC TIMER A/C Timer. Function A/C (ON-delay and OFF-delay)</p>	 <p>TIMER BH TIMER B/H Timer. Function BH. (adjustable pulsed signal)</p>	 <p>TIMER BW TIMER B/W Timer. Function BW (pulse on rising/falling edge)</p>
 <p>TIMER Li TIMER L/i Pulse generator (ON-delay, OFF-delay)</p>	 <p>BISTABLE BISTABLE Impulse relay function</p>	 <p>SET- RESET Bistable latching - Priority assigned either to SET or RESET function</p>
 <p>BOOLEAN BOOLEAN Allows logic equations to be created between connected inputs</p>	 <p>CAM CAM Cam programmer</p>	 <p>PRESET COUNT PRESET COUNT Up/down counter</p>
 <p>UP DOWN COUNT UP DOWN COUNT Up/down counter with external preset</p>	 <p>PRESET H-METER PRESET H-METER Hour counter (hour, minute preset)</p>	 <p>TIME PROG TIME PROG Time programmer, weekly and annual.</p>
 <p>GAIN GAIN Allows conversion of an analog value by change of scale and offset.</p>	 <p>TRIGGER TRIGGER Defines an activation zone with hysteresis</p>	 <p>MUX MUX Multiplexing functions on 2 analog values</p>
 <p>MAX COMP IN ZONE MAX VAL MIN Zone comparison (Min. ≤ Value ≤ Max.)</p>	 <p>ADD/SUB Add and/or subtract function</p>	 <p>MUL/DIV Multiply and/or divide function</p>
 <p>DISPLAY DISPLAY Display of digital and analog data, date, time, messages for Human-Machine interface.</p>	 <p>COMPARE COMPARE Comparison of 2 analog values using the operands =, >, <, ≤, ≥.</p>	 <p>STATUS STATUS Access to smart relay status</p>
 <p>ARCHIVE ARCHIVE Storage of 2 values simultaneously</p>	 <p>SPEED COUNT SPEED COUNT Fast counting up to 1 kHz</p>	 <p>COM Sending of messages with communication interface (see page 32).</p>
<h3>SFC functions (2) (GRAFSET)</h3>		
 <p>RESET-INIT RESET-INIT Reinitializable step</p>	 <p>INIT STEP INIT STEP Initial step</p>	 <p>STEP STEP SFC step</p>
 <p>DIV-OR 2 DIV-OR 2 Divergence to OR</p>	 <p>CONV-OR 2 CONV-OR 2 Convergence to OR</p>	 <p>DIV-AND 2 DIV-AND 2 Divergence to AND</p>
 <p>CONV-AND 2 CONV-AND 2 Convergence to AND</p>		
<h3>Logic functions</h3>		
 <p>AND AND AND function</p>	 <p>OR OR OR function</p>	 <p>NAND NAND NOT AND function</p>
 <p>NOR NOR NOT OR function</p>	 <p>XOR XOR Exclusive OR function</p>	 <p>NOT NOT NOT function</p>

(1) Function Block Diagram.

(2) Sequential Function Chart.

Zelio[®] Logic 2

Programmable Smart Relays

Compact and modular smart relays

General environment characteristics (except for communication Modem interface SR2 COM01, see page 37)

Product certifications			UL, CSA, GL (pending), C-Tick
Conformity with the low voltage directive	Conforming to 73/23/EEC		EN (IEC) 61131-2 (open equipment)
Conformity with the EMC directive	Conforming to 89/336/EEC		EN (IEC) 61131-2 (Zone B) EN (IEC) 61000-6-2, EN (IEC) 61000-6-3 (1) and EN (IEC) 61000-6-4
Degree of protection	Conforming to IEC/EN 60529		IP 20
Overvoltage category	Conforming to IEC/EN 60664-1		3
Degree of pollution	Conforming to IEC/EN 61131-2		2
Ambient air temperature around the device	Operation	°C (°F)	- 20 to + 55 (- 4 to + 131) + 40 (+ 104) in an enclosure, conforming to IEC 60068-2-1 and IEC 60068-2-2
	Storage	°C (°F)	- 40 to + 70 (- 40 to + 158)
Maximum relative humidity			95% without condensation or dripping water
Maximum operating altitude	Operation	m (ft.)	2000 (6562)
	Transport	m (ft.)	3048 (10 000)
Mechanical resistance	Immunity to vibration		IEC/EN 60068-2-6, test Fc
	Immunity to mechanical shock		IEC/EN 60068-2-27, test Ea
Resistance to electrostatic discharge	Immunity to electrostatic discharge		IEC/EN 61000-4-2, level 3
Resistance to HF interference (immunity)	Immunity to electromagnetic radiated fields		IEC/EN 61000-4-3, level 3
	Immunity to fast transients in bursts		IEC/EN 61000-4-4, level 3
	Immunity to shock waves		IEC/EN 61000-4-5
	Radio frequency in common mode		IEC/EN 61000-4-6, level 3
	Voltage dips and breaks (~)		IEC/EN 61000-4-11
	Immunity to damped oscillation waves		IEC/EN 61000-4-12
	Conducted and radiated emissions	Conforming to EN 55022/11 (Group 1)	
Screw terminals connection capacity (Tightening using Ø 3.5 screwdriver)	Flexible cable with cable end	mm ²	1 conductor: 0.25 to 2.5, cable: AWG 24 to AWG 14 2 conductors: 0.25 to 0.75, cable: AWG 24 to AWG 18
	Semi-solid cable	mm ²	1 conductor: 0.2 to 2.5 cable: AWG 25 to AWG 14
	Solid cable	mm ²	1 conductor: 0.2 to 2.5, cable: AWG 25 to AWG 14 2 conductors: 0.2 to 1.5, cable: AWG 24 to AWG 16
	Tightening torque	N.m (lbf-in)	0.5 (4.4)

Processing characteristics

Number of control scheme lines	With LADDER programming		120
Number of function blocks	With FBD programming		Up to 200
Cycle time		ms	10 to 50
Response time		ms	20 minimum
Back-up time (in the event of power failure)	Day/time		10 years (lithium battery) at 25 °C (77 °F)
	Program and settings		10 years (EEPROM memory cartridge)
Program memory checking			On each power-up
Clock drift			12 min/year 0 to 55 °C (32 to 131 °F) 6 sec/month at 25 °C (77 °F) and calibration
Timer block accuracy			1% ± 2 cycle time

--- 12 V supply characteristics

Smart relay type			SR2 B121JD	SR2 B201JD	SR3 B261JD
Primary	Nominal voltage	V	12		
Voltage limits	Including ripple	V	--- 10.4 to 14.4		
Nominal input current	Without extensions	mA	120	200	250
	With extensions	mA	-		
Power dissipated	Without extensions	W	1.5	2.5	3
	With extensions	W	-		
Micro-breaks	Permissible duration	ms	≤ 1 (repeated 20 times)		
Protection			Against reverse polarity		

(1) Except for the configuration SR3 B●●●BD + SR3 MBU01BD + SR3 XT43BD class A (class B: work in progress).

Zelio[®] Logic 2

Programmable Smart Relays

Compact and modular smart relays

— 24 V supply characteristics

Smart relay type			SR2 ●1●1BD	SR2 B122BD	SR2 ●201BD	SR2 B202BD	SR3 B101BD	SR3 B102BD	SR3 B261BD	SR3 B262BD	
Primary	Nominal voltage	V	24								
Voltage limits	Including ripple	V	19.2 to 30								
Nominal input current	Without extensions	mA	100				50		190		70
	With extensions	mA	–				100		160		300
Power dissipated	Without extensions	W	3		6		3		4		6
	With extensions	W	–		–		8		–		10
Micro-breaks	Permissible duration	ms	≤ 1 (repeated 20 times)								
Protection			Against reverse polarity								

~ 24 V supply characteristics

Smart relay type			SR2 ●121B	SR2 ●201B	SR3 B101B	SR3 B261B		
Primary	Nominal voltage	V	24					
Voltage limits		V	20.4 to 28.8					
Nominal frequency		Hz	50-60					
Nominal input current	Without extensions	mA	145		233		160	280
	With extensions	mA	–		–		280	415
Power dissipated	Without extensions	VA	4		6		4	7.5
	With extensions	VA	–		–		7.5	10
Micro-breaks	Permissible duration	ms	≤ 10 (repeated 20 times)					
rms insulation voltage		V	1780 (50-60 Hz)					

~ 100 to 240 V supply characteristics

Smart relay type			SR2 ●101FU	SR2 ●121FU	SR2 ●201FU	SR3 B101FU	SR3 B261FU	
Primary	Nominal voltage	V	100 to 240					
Voltage limits		V	85 to 264					
Nominal input current	Without extensions	mA	80/30		100/50		80/30	100/50
	With extensions	mA	–		–		80/40	80/60
Power dissipated	Without extensions	VA	7		11		7	12
	With extensions	VA	–		–		12	17
Micro-breaks	Permissible duration	ms	10					
rms insulation voltage		V	1780					

Discrete — input characteristics (inputs I1 to IA and IH to IR)

Smart relay type			SR● ●●●●JD	SR● ●●●●BD
Nominal value of inputs	Voltage	V	12	
	Current	mA	4	
Input switching limit values	At state 1	Voltage	≥ 5.6	
		Current	≥ 2	
	At state 0	Voltage	≤ 2.4	
		Current	< 0.9	
Input impedance at state 1		kΩ	2.7	
Conforming to IEC/EN 61131-2			Type 1	
Sensor compatibility	3-wire		Yes PNP	
	2-wire		No	
Input type			Resistive	
Isolation	Between supply and inputs		None	
	Between inputs		None	
Maximum counting frequency		kHz	1	
Protection	Reverse polarity protection		Control instructions not executed	

Zelio[®] Logic 2

Programmable Smart Relays

Compact and modular smart relays

Discrete or analog \square input characteristics (inputs IB to IG)

\square discrete inputs

Smart relay type		SR \bullet \bullet \bullet \bullet \bullet JD		SR \bullet \bullet \bullet \bullet \bullet BD
Nominal value of inputs	Voltage	V	12	24
	Current	mA	4	
Input switching limit values	At state 1	Voltage	V	≥ 7
		Current	mA	≥ 0.5
	At state 0	Voltage	V	≤ 3
		Current	mA	≤ 0.2
Input impedance at state 1		k Ω	14	12
Conforming to IEC/EN 61131-2		Type 1		
Sensor compatibility	3-wire	Yes PNP		
	2-wire	No		
Input type		Resistive		
Isolation	Between supply and inputs	None		
	Between inputs	None		
Maximum counting frequency		kHz	1	
Protection	Reverse polarity protection	Control instructions not executed		

\square analog inputs

Smart relay type		SR \bullet \bullet \bullet \bullet JD		SR \bullet \bullet \bullet \bullet BD
Input range		V	0 to 10 or 0 to 12	0 to 10 or 0 to 24
Input impedance		k Ω	14	12
Maximum non destructive voltage		V	14.4	30
Value of LSB		39 mV, 4 mA		
Input type		Common mode		
Conversion	Resolution	8 bits		
	Conversion time	Smart relay cycle time		
	Precision	at 25 °C (77 °F)	$\pm 5\%$	
		at 55 °C (131 °F)	$\pm 6.2\%$	
Repeat accuracy at 55 °C (131 °F)	$\pm 2\%$			
Isolation		Between analog channel & supply None		
Cabling distance		m	10 maximum, with shielded cable (sensor not isolated)	
Protection	Reverse polarity protection	Control instructions not executed		

Analog \square input characteristics (inputs IH, IJ and Pt.)

Smart relay type		SR \bullet \bullet \bullet \bullet JD		SR \bullet \bullet \bullet \bullet BD
Analog inputs	Application	0 - 10 V	0-20 mA	Pt100
	Assignable inputs	IH and IJ	IH and IJ	IJ
	Input range	0 to 10 Vdc	0 to 20 mA	- 25 to + 125 °C (- 13 to + 257 °F)
	Input impedance	Ω	18 k	246
	Maximum non destructive value	30 V	30 mA	-
	Value of LSB	9.8 mV	20 μ A	0.15 °C (32 °F)
	Input type	Common mode		Pt100 probe - IEC 751 3-wire
Conversion	Resolution	10 bits		
	Conversion time	Smart relay cycle time		
	Precision	at 25 °C (77 °F)	$\pm 1\%$	
		at 55 °C (131 °F)	$\pm 1\%$	
Repeat accuracy at 25 °C (77 °F)	$< \pm 1\%$		$< \pm 0.3\text{ °C (32 °F)}$	
Isolation		Between analog chan. & supply None		
Cabling distance		m (ft.)	10 (32.81) maximum, with shielded cable (sensor not isolated)	
Protection	Reverse polarity protection	Control instructions not executed		-

Discrete \sim input characteristics

Smart relay type		SR \bullet \bullet \bullet \bullet B		SR \bullet \bullet \bullet \bullet FU
Nominal value of inputs	Voltage	V	24	100 to 240
	Current	mA	4.4	0.6
	Frequency	Hz	47 to 63	
Input switching limit values	At state 1	Voltage	V	≥ 14
		Current	mA	> 2
	At state 0	Voltage	V	≤ 5
		Current	mA	< 0.5
Input impedance at state 1		k Ω	4.6	350
Configurable response time	State 0 to 1 (50/60 Hz)	ms	50	
	State 1 to 0 (50/60 Hz)	ms	50	
Isolation	Between supply and inputs	None		
	Between inputs	None		
Protection	Reverse polarity protection	Control instructions not executed		

Zelio[®] Logic 2

Programmable Smart Relays

Compact and modular smart relays

Relay output characteristics						
Smart relay type			SR2 ●●●/ SR3 B101●●/ SR3 XT61●●/ SR3 XT101●●	SR3 B261●●	SR3 XT141●●	
Operating limit values			V	~ 5 to 150 ~ 24 to 250		
Contact type				N/O		
Thermal current			A	8	8 outputs: 8 A 2 outputs: 5 A	
Electrical durability for 500 000 operating cycles	Utilization category	DC-12	V	24		
			A	1.5		
	DC-13	V	24 (L/R = 10 ms)			
		A	0.6			
	AC-12	V	230			
		A	1.5			
	AC-15	V	230			
		A	0.9			
Minimum switching capacity At minimum voltage of 12 V			mA	10		
Low power switching reliability of contact				12 V - 10 mA		
Maximum operating rate	No-load		Hz	10		
	At I _e (operational current)		Hz	0.1		
Mechanical life In millions of operating cycles				10		
Rated impulse withstand voltage (U _{imp}) Conforming to IEC/EN 60947-1 and IEC/EN 60664-1			kV	4		
Response time	Trip		ms	10		
	Reset		ms	5		
Built-in protection	Against short-circuits			None		
	Against overvoltage and overload			None		
Transistor output characteristics						
Smart relay type			SR● B●●2BD			
Operating limit values			V	19.2 to 30		
Load	Nominal voltage		V	~ 24		
	Nominal current		A	0.5		
	Maximum current		A	0.625 at 30 V		
Drop-out voltage At state 1			V	≤ 2 for I = 0.5 A		
Response time	Trip		ms	≤ 1		
	Reset		ms	≤ 1		
Built-in protection	Against overload and short-circuits			Yes		
	Against overvoltage (1)			Yes		
	Against inversions of power supply			Yes		
(1) If there is no volt-free contact between the smart relay output and the load.						
Analog output characteristics (QB, QC)						
Analog outputs	Output range		V	~ 0 to 10		
	Type of load			Resistive		
	Maximum load		mA	10		
	Value of LSB		mV	10		
Conversion	Resolution			10 bits		
	Conversion time			Smart relay cycle time		
	Precision	at 25 °C (77 °F)			± 1% of the full scale value	
		at 55 °C (131 °F)			± 1% of the full scale value	
Repeat accuracy at 55 °C (131 °F)			< ± 1%			
Isolation Between analog channel and supply				None		
Cabling distance			m (ft.)	10 (32.81) maximum, with shielded cable		
Built-in protection Reverse polarity protection				Yes		

Zelio[®] Logic 2

Programmable Smart Relays

Compact and modular smart relays

Electrical durability of relay outputs

(in millions of operating cycles, conforming to IEC 60947-5-1)

d.c. loads

DC-12 (1)

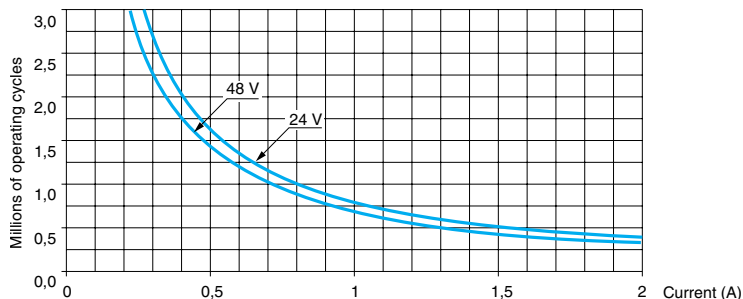

DC-13 (2)

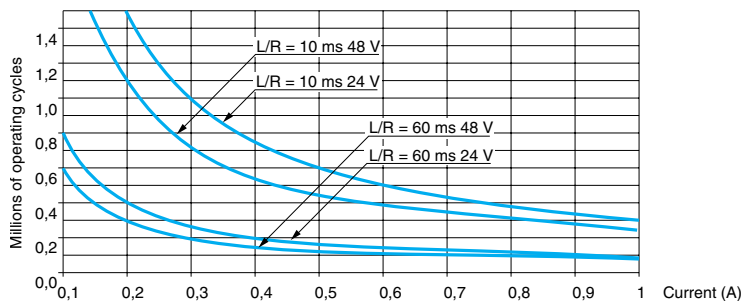

- (1) DC-12: switching resistive loads and photo-coupler isolated solid-state loads, $L/R \leq 1$ ms.
 (2) DC-13: switching electromagnets, $L/R \leq 2 \times (U_e \times I_e)$ in ms, U_e : rated operational voltage, I_e : rated operational current (with a protection diode on the load, DC-12 curves must be used with a coefficient of 0.9 applied to the number in millions of operating cycles).

Zelio[®] Logic 2

Programmable Smart Relays

Compact and modular smart relays

Electrical durability of relay outputs (continued)

(in millions of operating cycles, conforming to IEC 60947-5-1)

a.c. loads

AC-12 (1)

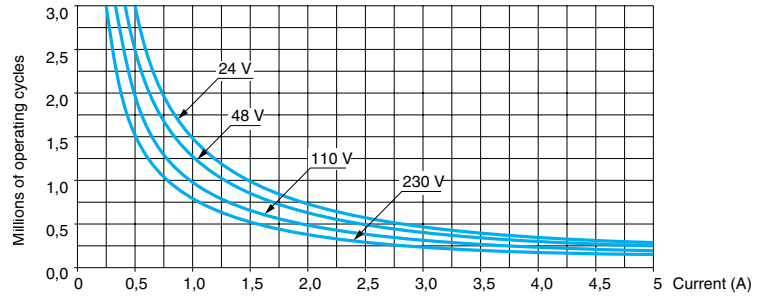

AC-14 (2)

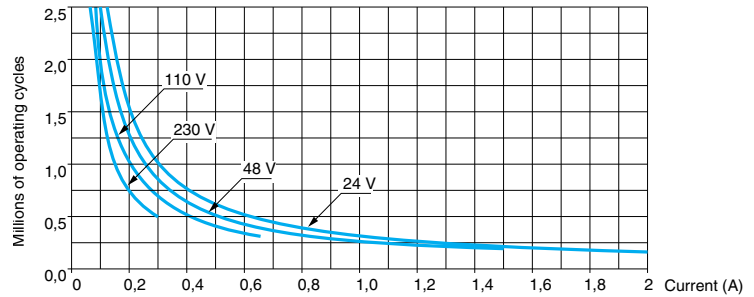

AC-15 (3)

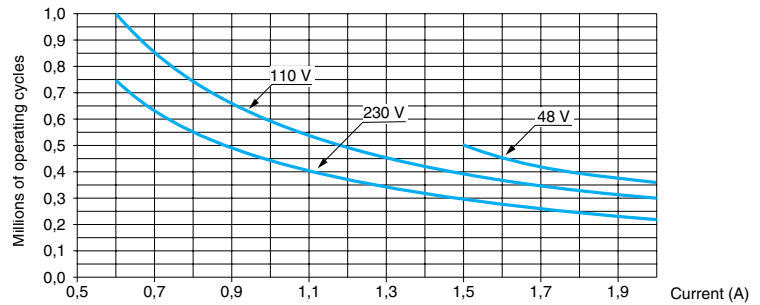

- (1) AC-12: switching resistive loads and photo-coupler isolated solid-state loads, $\cos \geq 0.9$.
 (2) AC-14: switching small electromagnetic loads ≤ 72 VA, make: $\cos = 0.3$, break: $\cos = 0.3$.
 (3) AC-15: switching electromagnetic loads > 72 VA, make: $\cos = 0.7$, break: $\cos = 0.4$.

Zelio[®] Logic 2

Programmable Smart Relays

Compact smart relays



SR2 A201BD



SR2 E121BD



SR2 PACK●●●

Compact smart relays with display

Number of I/O	Discrete inputs	Including 0-10 V analog inputs	Relay outputs	Transistor outputs	Clock	Reference	Weight kg
---------------	-----------------	--------------------------------	---------------	--------------------	-------	-----------	-----------

Supply $\overline{\text{---}}$ 12 V

12	8	4	4	0	Yes	SR2 B121JD	0.250
20	12	6	8	0	Yes	SR2 B201JD	0.380

Supply $\overline{\text{---}}$ 24 V

10	6	0	4	0	No	SR2 A101BD (1)	0.250
12	8	4	4	0	Yes	SR2 B121BD	0.250
	8	4	0	4	Yes	SR2 B122BD	0.220
20	12	2	8	0	No	SR2 A201BD (1)	0.380
	12	6	8	0	Yes	SR2 B201BD	0.380
	12	6	0	8	Yes	SR2 B202BD	0.280

Supply \sim 24 V

12	8	0	4	0	Yes	SR2 B121B	0.250
20	12	0	8	0	Yes	SR2 B201B	0.380

Supply \sim 100 to 240 V

10	6	0	4	0	No	SR2 A101FU (1)	0.250
12	8	0	4	0	Yes	SR2 B121FU	0.250
20	12	0	8	0	No	SR2 A201FU (1)	0.380
	12	0	8	0	Yes	SR2 B201FU	0.380

Compact smart relays without display

Number of I/O	Discrete inputs	Including 0-10 V analog inputs	Relay outputs	Transistor outputs	Clock	Reference	Weight kg
---------------	-----------------	--------------------------------	---------------	--------------------	-------	-----------	-----------

Supply $\overline{\text{---}}$ 24 V

10	6	0	4	0	No	SR2 D101BD (1)	0.220
12	8	4	4	0	Yes	SR2 E121BD	0.220
20	12	2	8	0	No	SR2 D201BD (1)	0.350
	12	6	8	0	Yes	SR2 E201BD	0.350

Supply \sim 24 V

12	8	0	4	0	Yes	SR2 E121B	0.220
20	12	0	8	0	Yes	SR2 E201B	0.350

Supply \sim 100 to 240 V

10	6	0	4	0	No	SR2 D101FU (1)	0.220
12	8	0	4	0	Yes	SR2 E121FU	0.220
20	12	0	8	0	No	SR2 D201FU (1)	0.350
	12	0	8	0	Yes	SR2 E201FU	0.350

Compact "discovery" packs

Number of I/O	Pack contents	Reference	Weight kg
---------------	---------------	-----------	-----------

Supply $\overline{\text{---}}$ 24 V

12	An SR2 B121BD compact smart relay with display, a connecting cable and "Zelio Soft 2" programming software supplied on CD-ROM.	SR2 PACKBD	0.700
20	An SR2 B201BD compact smart relay with display, a connecting cable and "Zelio Soft 2" programming software supplied on CD-ROM.	SR2 PACK2BD	0.850

Supply \sim 100 to 240 V

12	An SR2 B121FU compact smart relay with display, a connecting cable and "Zelio Soft 2" programming software supplied on CD-Rom.	SR2 PACKFU	0.700
20	An SR2 B201FU compact smart relay with display, a connecting cable and "Zelio Soft 2" programming software supplied on CD-Rom.	SR2 PACK2FU	0.850

(1) Programming on smart relay in LADDER language only.

Zelio® Logic 2

Programmable Smart Relays

Modular smart relays



SR3 B101BD



SR3 XT61BD



SR3 XT141BD



SR3 XT43BD

Modular smart relays with display

Number of I/O	Discrete inputs	Including 0-10 V analog inputs	Relay outputs	Transistor outputs	Clock	Reference	Weight kg
Supply \equiv 12 V							
26	16	6	10	0	Yes	SR3 B261JD (1)	0.400
Supply \equiv 24 V							
10	6	4	4	0	Yes	SR3 B101BD	0.250
	6	4	0	4	Yes	SR3 B102BD	0.220
26	16	6	10 (2)	0	Yes	SR3 B261BD	0.400
	16	6	0	10	Yes	SR3 B262BD	0.300
Supply \sim 24 V							
10	6	0	4	0	Yes	SR3 B101B	0.250
26	16	0	10 (2)	0	Yes	SR3 B261B	0.400
Supply \sim 100-240 V							
10	6	0	4	0	Yes	SR3 B101FU	0.250
26	16	0	10 (2)	0	Yes	SR3 B261FU	0.400

Discrete I/O extension modules (3)

Number of I/O	Discrete inputs	Relay outputs	Reference	Weight kg
Supply \equiv 12 V (for smart relay SR3 B261JD)				
6	4	2	SR3 XT61JD	0.125
10	6	4	SR3 XT101JD	0.200
14	8	6	SR3 XT141JD	0.220
Supply \equiv 24 V (for smart relays SR3 B●●●BD)				
6	4	2	SR3 XT61BD	0.125
10	6	4	SR3 XT101BD	0.200
14	8	6	SR3 XT141BD	0.220
Supply \sim 24 V (for smart relays SR3 B●●●B)				
6	4	2	SR3 XT61B	0.125
10	6	4	SR3 XT101B	0.200
14	8	6	SR3 XT141B	0.220
Supply \sim 100-240 V (for smart relays SR3 B●●●FU)				
6	4	2	SR3 XT61FU	0.125
10	6	4	SR3 XT101FU	0.200
14	8	6	SR3 XT141FU	0.220

Analog I/O extension modules

Number of I/O	Number of inputs	Including 0 - 10 V	Including 0 - 20 mA	Including Pt100	Output 0 - 10 V	Reference	Weight kg
4	2 (4)	2 max	2 max	1 max	2	SR3 XT43BD (1) (5)	0.110

Network communication module (3) (6)

For use on	Supply voltage	Reference	Weight kg
Modbus® network (slave)	\equiv 24 V	See page 31	0.300

Modular "discovery" packs

Number of I/O	Pack contents	Reference	Weight kg
Supply \equiv 24 V			
10	An SR3 B101BD modular smart relay, a connecting cable and "Zelio Soft 2" programming software supplied on CD-ROM.	SR3 PACKBD	0.700
26	An SR3 B261BD modular smart relay, a connecting cable and "Zelio Soft 2" programming software supplied on CD-ROM.	SR3 PACK2BD	0.850
Supply \sim 100 to 240 V			
10	An SR3 B101FU modular smart relay, a connecting cable and "Zelio Soft 2" programming software supplied on CD-Rom.	SR3 PACKFU	0.700
26	An SR3 B261FU modular smart relay, a connecting cable and "Zelio Soft 2" programming software supplied on CD-Rom.	SR3 PACK2FU	0.850

(1) Can only be used with "Zelio Soft 2" software version \geq V3.1.

(2) Including 8 outputs at maximum current of 8 A and 2 outputs at maximum current of 5 A.

(3) Power supply to the I/O extension and communication modules is via the modular smart relay.

(4) See page 26.

(5) Can only be used in FBD language.

(6) See pages 28 to 31.

Note : The smart relay and its associated extensions must have an identical voltage.

Zelio® Logic 2

Programmable Smart Relays

Compact and modular smart relays
Separate components



SR2 SFT01

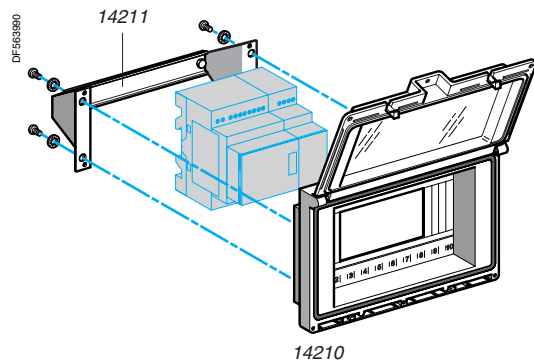

SR2 USB01

SR2 MEM01
SR2 MEM02

14210

“Zelio Soft 2” software for PC

Description	Application	Reference	Weight kg
Programming software “Zelio Soft 2”, multilingual	For PC, supplied on CD-ROM (1), compatible with Microsoft® Windows 98, NT, 2000, XP and ME.	SR2 SFT01	0.200
Connecting cable	Between the PC (SUB-D, 9-pin connector) and the smart relay, length: 3 m (9.8 ft.)	SR2 CBL01	0.150
	Between the PC (USB connector) & the smart relay, length: 3 m (9.8 ft.)	SR2 USB01	0.100
Interface	For USB port (to be used with cable SR2 CBL01), length: 1.8 m (5.9 ft.)	SR2 CBL06	0.350

Memory cartridges (2)

Description	Application	Reference	Weight kg
EEPROM memory cartridge	For software incorporated in the smart relay version ≤ 2.4 (no firmware of any version)	SR2 MEM01	0.010
	For firmware (software incorporated in the smart relay) version ≥ 3.0	SR2 MEM02	0.010

Modem communication interface (3)

Description	Supply	Reference	Weight kg
Modem communication interface	≐ 12 to 24 V	See page 38	

Power supplies

Input voltage	Nominal output voltage	Reference	Weight kg
~ 100 to 240 V (47 to 63 Hz)	≐ 12 V or ≐ 24 V	See page 45	–

Mounting accessories (4)

Description	Mounting capacity	Application	Reference	Weight kg
Dust and damp-proof enclosure with split blanking plate arrangement, fitted with IP 55 dust and damp-proof window with hinged flap.	- 1 or 2 SR2 modules with 10 or 12 I/O, or - 1 SR2 module with 20 I/O, or - 1 SR3 module with 10 I/O + 1 I/O extension module (6, 10 or 14 I/O), or - 1 SR3 module with 26 I/O + 1 I/O extension module (6 I/O).	For mounting through a door	14210	0.350
Mounting bracket and symmetrical mounting rail	–	For mounting enclosure 14210 through a door panel	14211	0.210

Documentation

Description	Application	Language	Reference	Weight kg
User's manual	For direct programming on the smart relay	English	SR2 MAN01EN	0.100
		French	SR2 MAN01FR	0.100
		German	SR2 MAN01DE	0.100
		Spanish	SR2 MAN01ES	0.100
		Italian	SR2 MAN01IT	0.100
		Portuguese	SR2 MAN01PO	0.100

(1) CD-ROM comprising “Zelio Soft 2” software, an application library, a self-training manual, installation instructions and a user's manual.

(2) Program loading using memory cartridge SR2 MEM02 is incompatible with Modem communication interface SR2 COM01.

(3) See pages 32 to 41.

(4) Products marketed under the Merlin Gerin™ brand.

Compact and modular smart relays

SR●●10●●● (10 I/O), SR2●12●●● (12 I/O)

Mounting on 35 mm  rail

Screw mounting (retractable lugs)

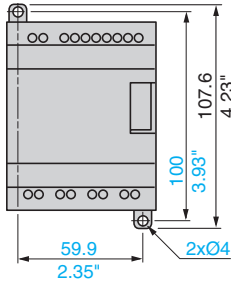
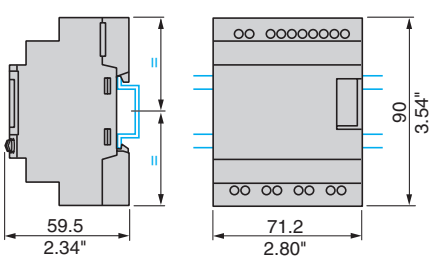

Dual Dimensions $\frac{\text{mm}}{\text{inches}}$

SR2●20●●● (20 I/O), SR3 B26●●● (26 I/O)

Mounting on 35 mm  rail

Screw mounting (retractable lugs)

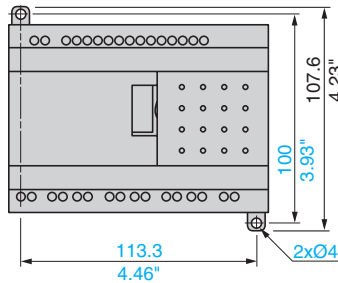
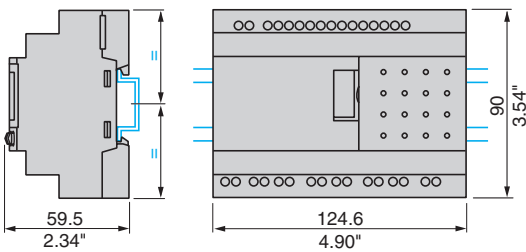

I/O extension modules

SR3 XT43BD (4 I/O), SR3 XT61●● (6 I/O), SR3 XT101●● and SR3 XT141●● (10 and 14 I/O)

Mounting on 35 mm  rail

Screw mounting (retractable lugs)

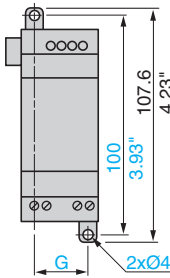
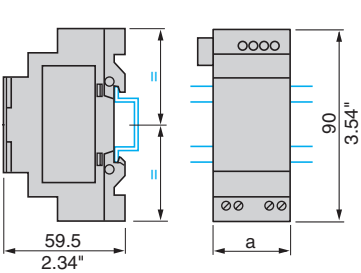

SR3	a	G
XT43BD	35.5 (1.39")	25 (0.98")
XT61●●	35.5 (1.39")	25 (0.98")
XT101●●	72 (2.83")	60 (2.36")
XT141●●	72 (2.83")	60 (2.36")

Enclosure + mounting bracket

14210 + 14211

Cut-out

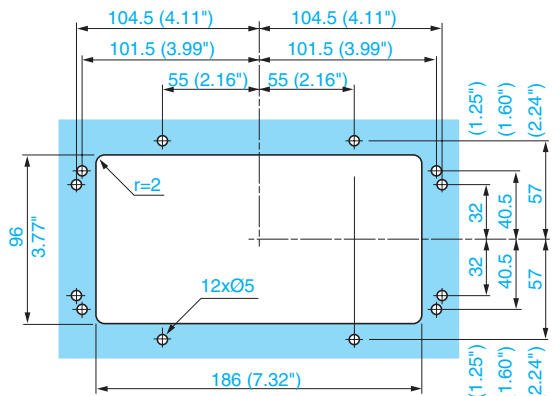
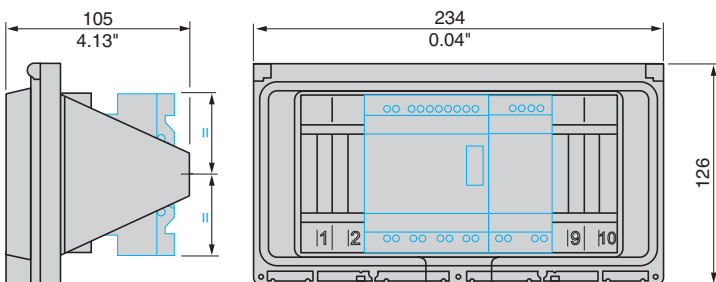

Connection of smart relays on \approx supply

SR● ●●●1BD, SR● ●●●1JD

SR2 B●●2BD and SR3 B●●2BD

SR3 B261●D

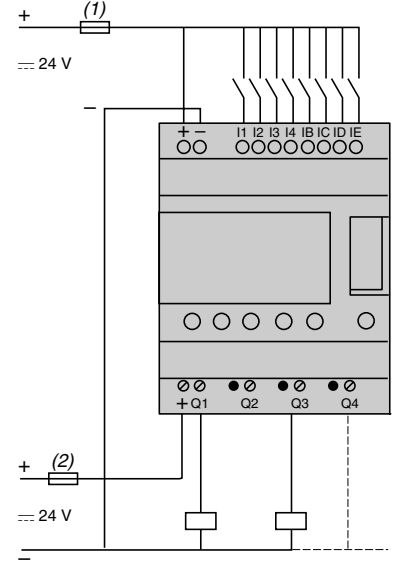
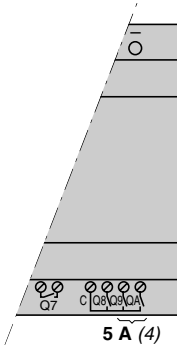
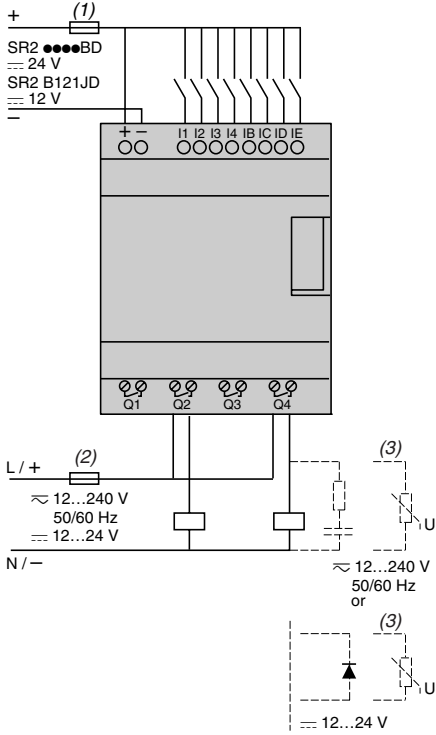

- (1) 1 A quick-blow fuse or circuit-breaker.
- (2) Fuse or circuit-breaker.
- (3) Inductive load.
- (4) Q9 and QA: 5 A.

Discrete input used for 3-wire sensors

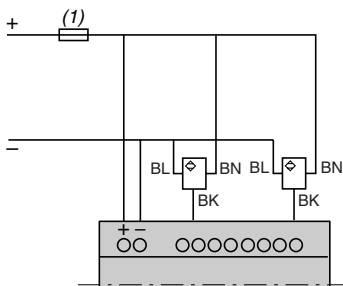

- (1) 1 A quick-blow fuse or circuit-breaker.

Connection of smart relays on $\bar{\text{---}}$ supply (continued)

Analog inputs

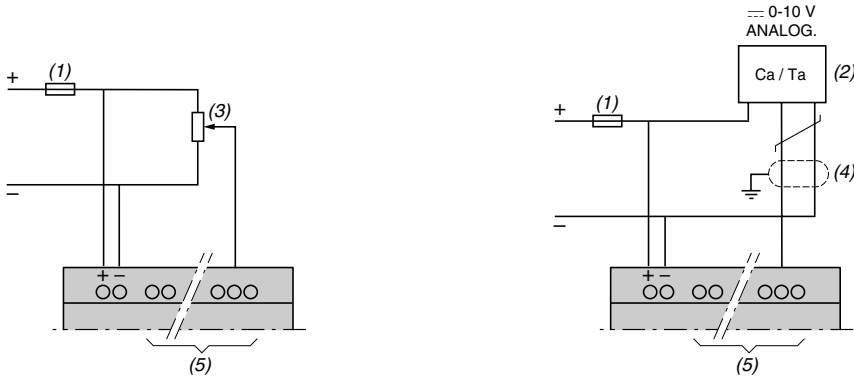

- (1) 1 A quick-blow fuse or circuit-breaker.
- (2) Ca: Analog sensor / Ta: Analog transmitter.
- (3) Recommended values: 2.2 k Ω / 0.5 W (10 k Ω max.).
- (4) Shielded cables, maximum length 10 m (32.81 ft.).
- (5) Analog inputs according to smart relay, see table below:

Smart relays	Analog inputs
SR2 ●12●●D	IB to IE
SR2 A201BD	IB and IC
SR2 D201BD	IB and IC
SR2 B20●●D	IB to IG
SR2 E201BD	IB to IG
SR3 B10●●D	IB to IE
SR3 B26●●D	IB to IG

Connection of smart relays on $\bar{\text{---}}$ supply, with discrete I/O extension modules

SR3 B●●●JD + SR3 XT●●●JD, SR3 B●●●BD + SR3 XT●●●BD

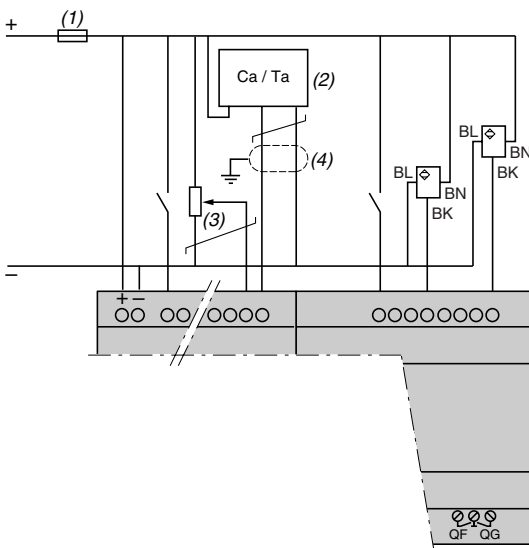

Note: QF and QG: 5 A for SR3 XT141●●

- (1) 1 A quick-blow fuse or circuit-breaker.
- (2) Ca: Analog sensor / Ta: Analog transmitter.
- (3) Recommended values: 2.2 k Ω / 0.5 W (10 k Ω max.).
- (4) Shielded cables, maximum length 10 m (32.81 ft.).

Connection of smart relays on \bar{a} supply, with analog I/O extension module

SR3 B●●●BD + SR3 XT43BD

Connection alternatives

0 - 10 V	0 - 20 mA	Pt100
2	0	0
1	1	0
0	2	0
1	0	1
0	1	1

Application example with 1 x 0 - 10 V input and 1 x Pt100 input

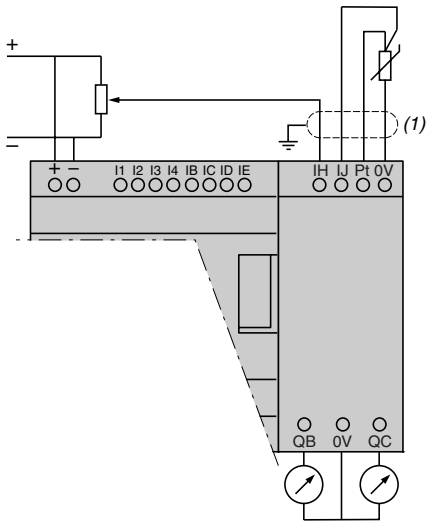

(1) Shielded cables, maximum length 10 m (32.81 ft.).

Application example with 1 x 0 - 20 mA input and 1 x 0 - 10 V input

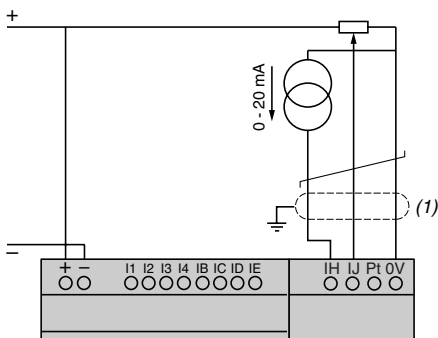

(1) Shielded cables, maximum length 10 m (32.81 ft.).

Connection of smart relays on ~ supply

SR● ●●●1B, SR● ●●●1FU

SR3 B261B and SR3 B261FU

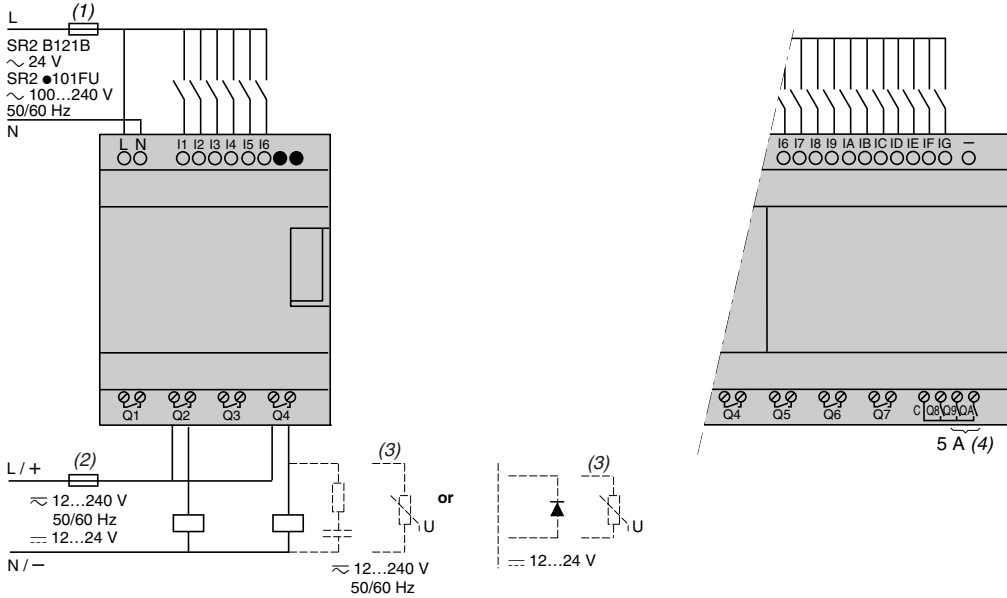

- (1) 1 A quick-blow fuse or circuit-breaker.
- (2) Fuse or circuit-breaker.
- (3) Inductive load.
- (4) Q9 and QA: 5 A.

With discrete I/O extension module

SR3 B●●●B + SR3 XT●●●B, SR3 B●●●FU + SR3 XT●●●FU

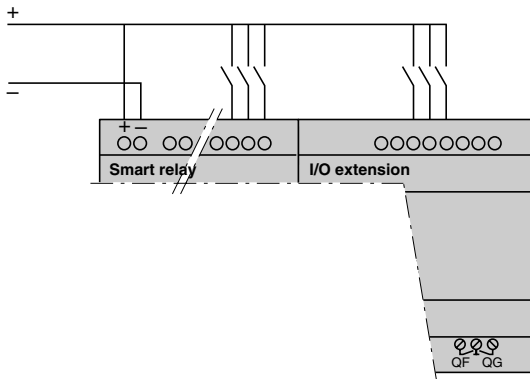

Note: QF and QG: 5 A for SR3 XT141●●

Zelio® Logic 2 Programmable Smart Relays

Modbus® network slave communication module



SR3 MBU01BD

Combination of smart relays with communication and I/O extension modules

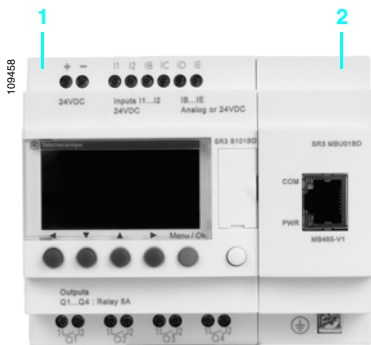

- 1 Modular smart relay (10 or 26 I/O)
- 2 Modbus network slave communication module

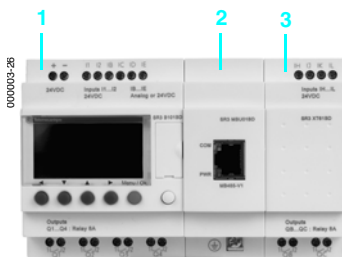

- 1 Modular smart relay (10 or 26 I/O)
- 2 Network communication module
- 3 I/O extension module: discrete (6, 10 or 14 I/O) or analog (4 I/O)

⚠ The order shown above must be observed when using a Modbus network slave communication module and a discrete or analog I/O extension module. An I/O extension module cannot be fitted before the Modbus network slave communication module.

Presentation

The Modbus protocol is of the master/slave type.

Two exchange methods are possible:

- request/reply: the request from the master is addressed to a specific slave. The master waits for the reply to be returned by the slave polled,
- distribution: the master distributes a request to all the slave stations on the bus. These stations execute the instruction without sending a reply.

Zelio Logic modular smart relays are connected to the Modbus network via the Modbus network slave communication module. This module is a slave that is not electrically isolated.

The Modbus network slave communication module must be connected to an SR3 B●●●BD modular smart relay, with a 24 V supply only (no other voltages are available).

Configuration

The Modbus network slave communication module can be configured:

- independently, using the buttons on the smart relay,
- on a PC, using "Zelio Soft 2" software, see page 14102/16.

When using a PC, programming can be performed either in LADDER language or in function block diagram (FBD) language, see pages 12 and 13.

Connection example

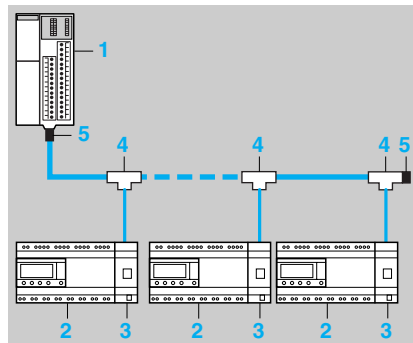

- 1 Modbus Master programmable controller (for example Twido® PLC).
- 2 Zelio Logic 2 programmable smart relay.
- 3 Modbus network slave communication module.
- 4 T-junction.
- 5 Line end adaptors.

Function description

- The Modbus network slave communication module is connected to a 2-wire or 4-wire Modbus network.
- The maximum length of the network is 1000 m (3281 ft.) 9600 bauds max., AWG 26.
- A maximum of 32 slaves can be connected to the Modbus network, or a maximum of 247 slaves with repeaters.
- Line end adaptors must be fitted to both ends of the line (1 nF/10 V, 120 Ω /0.25 W in series).
- The line must be polarized (470 Ω /0.25 W resistors) (1).
- The connection cable and its RJ45 male connectors must be shielded.
- The "COMMON" signal must be connected directly to the protective ground at one point on the bus.

(1) The polarization resistors must be managed by the master.

Description

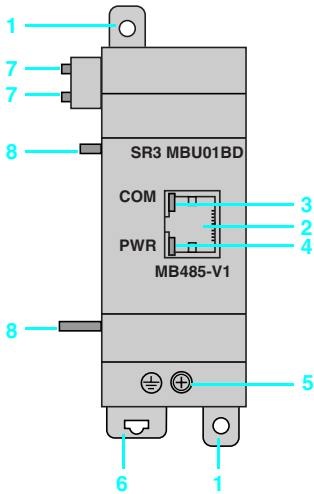

The Modbus network slave communication module **SR3 MBU01BD** comprises:

- 1 Two retractable mounting feet.
- 2 A Modbus network connection (RJ45 shielded female connector).
- 3 A communication LED (COM).
- 4 A "Power on" LED (PWR).
- 5 A screw terminal block for the protective ground connection.
- 6 A spring clip for mounting on a 35 mm (1.38") mounting rail.
- 7 Two locating pegs.
- 8 Two locating pegs for clip-on mounting.

Environment characteristics

Product certifications		UL, CSA, GL (pending), C-TICK
Conformity with the low voltage directive	Conforming to 73/23/EEC	EN (IEC) 61131-2 (open equipment)
Conformity with the EMC directive	Conforming to 89/336/EEC	EN (IEC) 61131-2 (Zone B) EN (IEC) 61000-6-2, EN (IEC) 61000-6-3 and EN (IEC) 61000-6-4
Degree of protection	Conforming to IEC/EN 60529	IP 20
Overvoltage category	Conforming to IEC/EN 60664-1	3
Degree of pollution	Conforming to IEC/EN 61131-2	2
Ambient air temperature around the device	Operation	°C (°F) - 20 to + 55 (-4 to +131) + 40 (+104) in an enclosure, conforming to IEC 60068-2-1 and IEC 60068-2-2
	Storage	°C (°F) - 40 to + 70 (-40 to 158)
Maximum relative humidity		95% without condensation or dripping water
Maximum operating altitude	Operation	m (ft.) 2000 (6562)
	Transport	m (ft.) 3048 (10 000)
Mechanical resistance	Immunity to vibration	IEC/EN 60068-2-6, test Fc
	Immunity to mechanical shock	IEC/EN 60068-2-27, test Ea
Resistance to electrostatic discharge	Immunity to electrostatic discharge	IEC/EN 61000-4-2, level 3
Resistance to HF interference (immunity)	Immunity to electromagnetic radiated fields	IEC/EN 61000-4-3, level 3
	Immunity to fast transients in bursts	IEC/EN 61000-4-4, level 3
	Immunity to shock waves	IEC/EN 61000-4-5
	Radio frequency in common mode	IEC/EN 61000-4-6, level 3
	Voltage dips and breaks (~)	IEC/EN 61000-4-11
	Immunity to damped oscillation waves	IEC/EN 61000-4-12
Conducted and radiated emissions	Conforming to EN 55022/11 (Group 1)	Class B

Parameter entry

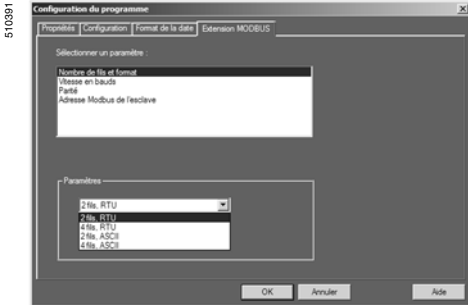

Software workshop parameter entry window

Parameters can be entered either using “Zelio Soft 2” software or directly using the buttons on the Zelio Logic 2 programmable smart relay.

When the “RUN” instruction is given, the Zelio Logic 2 programmable smart relay initializes the Modbus network slave communication module in a configuration previously defined in the basic program.

The Modbus network slave communication module has 4 parameters:

- number of UART wires and format of the frames on the Modbus network,
- transmission speed,
- parity,
- network address of the Modbus module.





The default parameter settings are as follows: 2-wire, RTU, 19 200 bauds, even parity, address #1.

Parameter entry	Options
Number of wires	2 or 4
Frame format	RTU or ASCII
Transmission speed in bauds	1200, 2400, 4800, 9600, 19 200, 28 800, 38 400, 57 600
Parity	None, even, odd
Network address	1 to 247

Addressing of Modbus exchanges

LADDER programming (1)

In LADDER mode, the 4 data words (16 bits) to be exchanged cannot be accessed by the application. Transfers with the master are implicit and are effected in a way that is totally transparent.





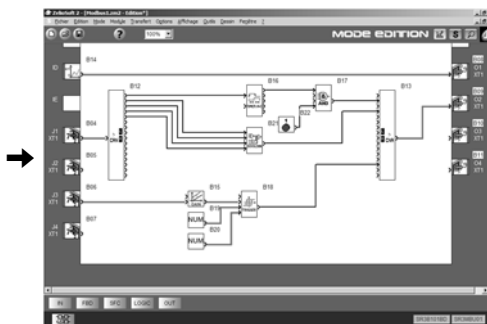

Modbus exchanges	Code	Number of words
Image of smart relay I/O	Read 03	4
  	Read/Write 16, 06 or 03	4
Status 	Read 03	1

Function block diagram (FBD) programming (2)

In FBD mode, the 4 input data words (16 bits) (J1XT1 to J4XT1) and the 4 output data words (O1XT1 to O4XT1) can be accessed by the application. Dedicated function blocks make it possible to:

- break down a ‘complete’ type input (16 bits) into 16 separate “bit” type outputs.
 - example: break down a Modbus type input (J1XT1 to J4XT1) and copy these status values to discrete outputs.
- make up a ‘complete’ type output (16 bits) from 16 separate “bit” type outputs.
 - example: transfer the status value of the discrete inputs or the status of a function to a Modbus type output (O1XT1 to O4XT1).



Modbus exchanges	Code	Number of words
	Read/Write 16, 06 or 03	4
	Read 03	4
  	Read/Write 16, 06 or 03	4
Status 	Read 03	1

(1) See page 12.
(2) See page 13.

References



SR3 MBU01BD

Modbus network slave communication module

For use with	Reference	Weight kg
Modular smart relays SR3 B●●1BD and SR3 B●●2BD (1)	SR3 MBU01BD	0.110

Connection accessories

Description	Reference	Weight kg
T-junctions	Complete with 0.3 m (0.98 ft.) cable	VW3 A8 306TF03
	Complete with 1 m cable	VW3 A8 306TF10
	Without cable	170 XTS 04100
Cables with 2 x RJ45 connectors	Length 0.3 m (0.98 ft.)	VW3 A8306R03
	Length 1 m (3.28 ft.)	VW3 A8306R10
	Length 3 m (9.8 ft.)	VW3 A8306R30

(1) Compatible with SR3 B●●2BD featuring hardware version "H1.0.01", available since June 2005

Dimensions and mounting

Side view

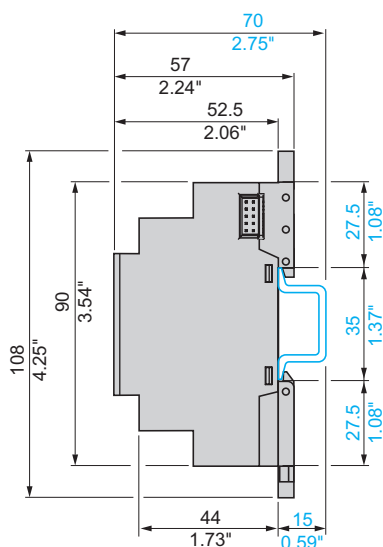

Rail mounting

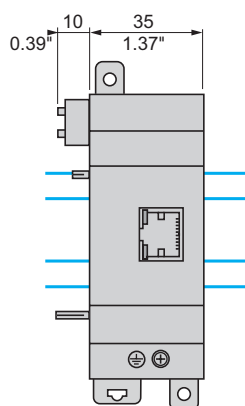

Screw mounting

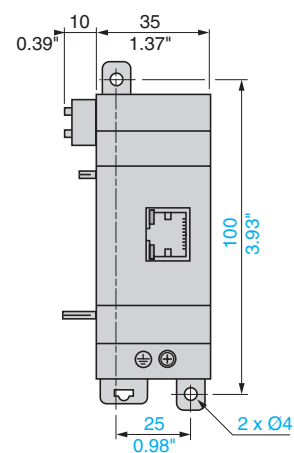

Dual Dimensions $\frac{\text{mm}}{\text{inches}}$

Zelio® Logic 2

Programmable Smart Relays

Modem communication interface

523083



SR2 COM01

Presentation

The communication products in the Zelio Logic 2 range are primarily designed for monitoring or remote control of machines or installations which operate without personnel.

Examples:

- monitoring of lift pumps, livestock premises (ventilation, food level, etc.), refrigeration units, car-washes,
- alert in the event of failure of industrial or domestic heating boilers,
- remote control of lighting: car parks, warehouses,
- remote control and monitoring of escalators in large stores, in the transport sector,
- refuse compact or full alert.

The communication range comprises:

- a communication interface connected between a smart relay and a Modem,
- GSM (1) or analog (PSTN) (2) Modems,
- "Zelio Logic Alarm" software.

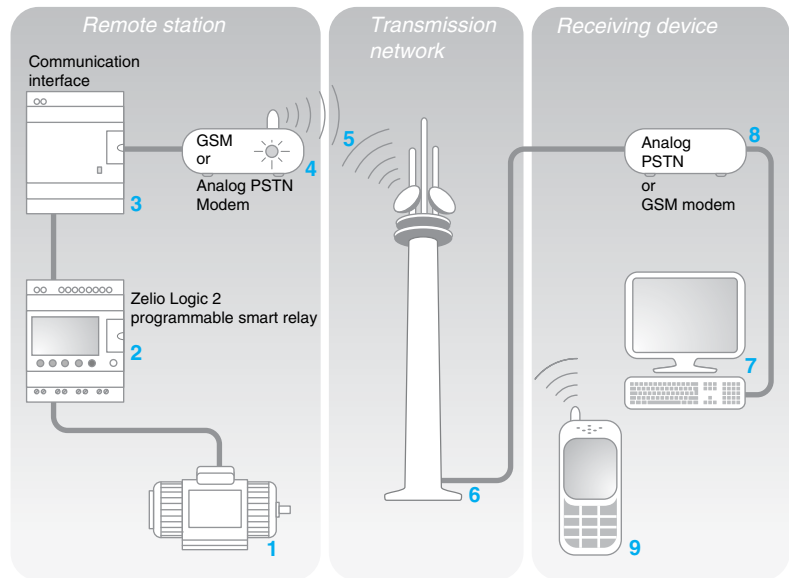

The system comprises:

- a *Remote station*, machine or installation to be monitored **1**: control is achieved using a smart relay with clock from the "Zelio Logic" SR● B●●●●● or SR2 E●●●●● **2** range, via its inputs and outputs. The smart relay is connected via a communication interface **3** to a GSM (1) type Modem **4**, or, when a telephone line is available nearby, to an analog PSTN modem (2),
- the GSM **5** or analog **6** TRANSMISSION NETWORK provided by different telecommunication operators,
- a monitoring or control *Receiving device*, which may be one of the following:
 - a PC **7** fitted with an analog PSTN or GSM Modem **8**,
 - or a GSM telephone **9**.

Note: the majority of Modems built into PCs can be used.

Various combinations are possible between the types of Modem used on the *Remote station* and the type of *Receiving device* (PC + Modems or GSM telephone).

The type of architecture selected will therefore depend mainly on:

- whether or not an analog PSTN telephone line is available,
- whether or not it is necessary to send SMS messages, see page 35.

(1) Global System Mobile.

(2) Public Switched Telephone Network.

Zelio® Logic 2

Programmable Smart Relays

Modem communication interface

Presentation (continued)

Smart relay (*Remote station*)

The smart relay, as on an independent machine or installation, is used for control (1). It contains the application program created using "Zelio Soft 2" software.

The smart relay may be selected from the various models in the Zelio Logic 2 range:

- for all supply voltages,
- with 10, 12, 20 or 26 I/O (up to 40 I/O with discrete extension module),
- with or without display,
- with clock.

The firmware version of the smart relay must be V3.1. or above.

Modem communication interface (*Remote station*)

The Modem communication interface allows messages, telephone numbers and calling conditions to be stored.

When the calling conditions are met, the messages, as well as any values to be sent, are date-stamped and stored in the interface.

The Modem communication interface scales analog values to the physical values (degree, bar, Pascal, etc.) required by the user.

Modems

Either GSM or analog PSTN type Modems can be used on both the *Remote station* and PC type *Receiving devices* (when the PC is not fitted with an internal Modem).

GSM modem

In order to exploit all the capabilities associated with Modem communication, the Modem(s) must be fitted with DATA type SIM cards. VOICE type SIM cards may be used but some functions will not be available. See table on page 35.

"Zelio Logic Alarm" alarm management software (PC type *Receiving device*)

This software makes it possible to:

- receive, classify and export alarm messages,
- read or remotely force the status of program elements (inputs, outputs, control relays, timing or counting values, etc.),
- send control instructions (RUN, STOP, setting the time of the smart relay, etc.),
- send specific instructions (modifying access rights, recipients, etc.).

(1) *Zelio Logic smart relays, see pages 8 to 28.*

Description

The communication interface Zelio Logic SR2 COM01 comprises:

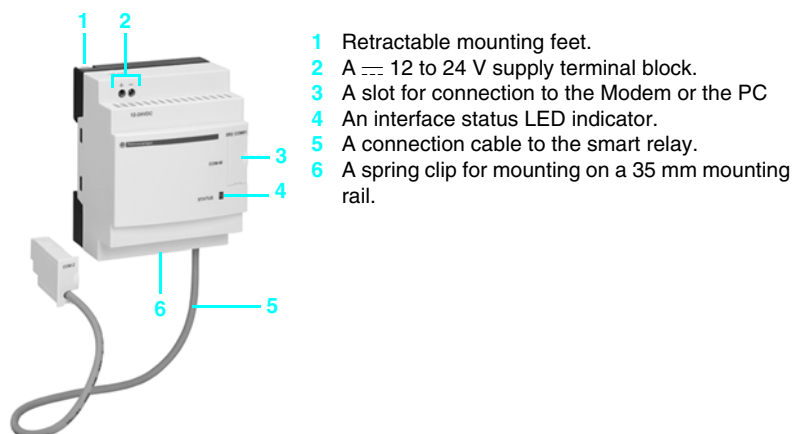

- 1 Retractable mounting feet.
- 2 A $\bar{\text{—}}$ 12 to 24 V supply terminal block.
- 3 A slot for connection to the Modem or the PC
- 4 An interface status LED indicator.
- 5 A connection cable to the smart relay.
- 6 A spring clip for mounting on a 35 mm mounting rail.

Zelio® Logic 2

Programmable Smart Relays

Modem communication interface

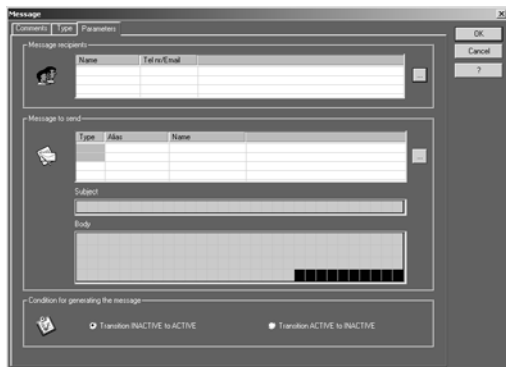

Functions

Sending of alerts

This function makes it possible to send an alert to a *Receiving device*. When the calling condition is met, a message is sent to one or several telephone numbers or e-mail addresses.

Types of message:

- alert message to a PC with Modem and “Zelio Logic Alarm” software,
- SMS message (1) to a GSM telephone,
- e-mail via SMS (1) (2).

One or all of the solutions can be selected simultaneously.

The *Remote station* to be monitored initiates the call.

The telephone line is only used while the alert message is being transmitted.

Up to 28 messages can be used.

These messages consist of:

- a 160 character text, which may contain a discrete and/or analog value (counting values, analog input voltages that can be scaled, etc.).
- 1 to 10 recipient telephone numbers/e-mail addresses.

Receipt of instruction

This function allows the status or the value of a program element to be modified from the *Receiving device*.

The operator initiates the call using the *Receiving device* (PC or GSM telephone). It is then possible to force the status of the discrete and/or analog value of each of the 28 messages.

Remote dialogue using “Zelio Soft 2”

This function enables use of the Transfer, Monitoring and Diagnostics modes available in “Zelio Soft 2”, via the *Transmission network* instead of the physical link (cable SR2 USB01 or SR2 CBL01) between the product (*Remote station*) and the PC (*Receiving device*).

It is then possible to:

- transfer a program created on a PC station to the *Remote station*,
- transfer a program installed on the *Remote station* to the PC station,
- modify, from the PC, the receiving device telephone numbers/e-mail addresses, and the alert sending conditions,
- update the firmware in the smart relay and the Modem communication interface,
- display and modify discrete and analog values,
- perform diagnostics on the smart relay and on the Modem communication interface.

(1) Requires the use of a GSM Modem on the *Remote station* side.

(2) Verify with the *Transmission network* operator that the e-mail by SMS service is available.



Zelio® Logic 2

Programmable Smart Relays

Modem communication interface

Functions available depending on the hardware architecture and/or type of SIM card

Function	Remote station device				
	Analog PSTN Modem	GSM Modem			
		Type of SIM card			
		DATA	DATA N°	VOICE N°	VOICE
Send alert/receive instruction with GSM telephone					
Send alert/receive instruction with PC running "Zelio Logic Alarm" software (1)					
Transfer program Update firmware Monitoring					
Send alert to e-mail address					

 Functions available
 Functions not available

Note: Instructions cannot be transmitted by e-mail.

(1) When using a GSM Modem on the PC side, the SIM card must have a DATA number.

Zelio[®] Logic 2

Programmable Smart Relays

Modem communication interface

Installation set-up

Setting-up of the installation or the machine to be monitored involves 2 steps:

Connection for programming the smart relay and the interface

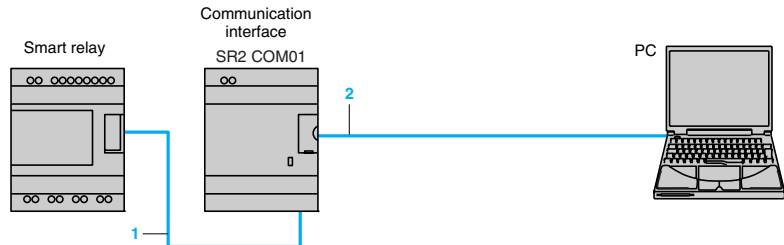

- 1 Interface cable marked COM-Z
- 2 Cable SR2 USB01 or SR2 CBL01.

After having powered-up the smart relay and the interface, the application program can be transferred in order to simultaneously:

- load the automation system program into the smart relay,
- load the alert conditions, messages and telephone numbers/e-mail addresses into the interface.

This operation can also be carried out remotely using "Transfer" mode, after having made the operating connections described below.

△ Program loading using memory cartridges SR2 MEM01 or SR2 MEM02 is incompatible with Modem communication interface SR2 COM01.

Operating connections

Analog PSTN modem

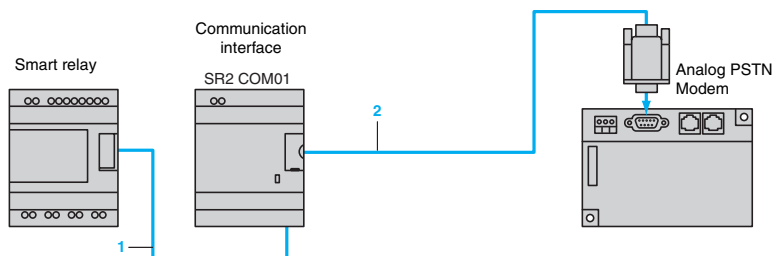

- 1 Interface cable marked COM-Z.
- 2 Cable SR2 CBL07 included with the interface.

GSM Modem

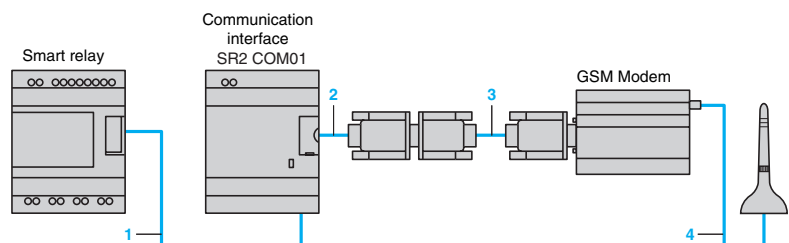

- 1 Interface cable marked COM-Z.
- 2 Cable SR2 CBL07 included with the interface.
- 3 SUB-D 9/SUB-D 15 cable included with the Modem
- 4 Antenna and cable included with the Modem.

Environment characteristics of communication interface SR2 COM01

Product certifications	Environment category C		UL, CSA, C-Tick
Degree of protection			IP 20
Ambient air temperature	Operation	°C (°F)	- 20 to + 55 (- 4 to 131) conforming to IEC/EN 60068-2-1 and 60068-2-2
	Storage	°C (°F)	- 25 to + 70 (- 13 to 158) conforming to IEC/EN 61131-2
Maximum relative humidity			95% without condensation or dripping water
Maximum operating altitude		m (ft.)	2000 (6562)
Mechanical resistance	Vibration resistance		Conforming to IEC/EN 60068-2-6 test Fc ± 1 mm (0.04") 2 to 13.2 Hz, ± 0.15 mm ((0.01") 13.2 to 57.6 Hz 2 gn (57.6 to 150 Hz
	Shock resistance		Conforming to IEC/EN 60068-2-27 test Ea
Resistance to electrostatic discharge			Conforming to IEC/EN 61000-4-2 level 3, 8 kV air, 6 kV at the contacts
Resistance to HF interference	Immunity to radiated electromagnetic fields		Conforming to IEC/EN 61000-4-3 level 3, 10 V per metre
	Immunity to fast transients in bursts		Conforming to IEC/EN 61000-4-4 level 3
	Immunity to shock waves		Conforming to IEC/EN 61000-4-5, on common mode supply 1 kV, serial mode supply 0.5 kV
	Immunity to damped oscillation waves		Conforming to IEC/EN 61000-4-12, on 1 kV supply, 30 seconds, 4 periods
	Conducted interference induced by radiated fields		IEC/EN 61000-4-6, 10 kHz to 80 MHz level 3: 10 V
Connection to screw terminals (tightened using Ø 3.5 screwdriver)	Flexible cable with cable end	mm ²	1 conductor: 0.14 to 1.5, AWG26 to AWG16 cable 2 conductors: 0.14 to 0.75, AWG26 to AWG18 cable
	Semi-solid cable	mm ²	1 conductor: 0.14 to 2.5, AWG26 to AWG14 cable
	Solid cable	mm ²	1 conductor: 0.14 to 2.5, AWG26 to AWG14 cable 2 conductors: 0.14 to 1.5, AWG26 to AWG16 cable
	Tightening torque	Nm	0.6

Supply characteristics

Interface type			SR2 COM01	SR2 MOD01	SR2 MOD02
Nominal voltage		V	--- 12 to 24		
Voltage limits		V	--- 10 to 28.8	--- 10 to 30	--- 5.5 to 32
Maximum ripple			5 %	–	–
Nominal current	--- 12 V	mA	30	140	125
	--- 24 V	mA	30	70	60
	Current peak on power-up	mA	550	9600	2100 on 5.5 V
Power dissipated		W	1.1	1.7	1.5
Micro-breaks	Permissible duration		1 ms, repeated 20 times	–	–
Protection	Integrated		Against reversed polarity	–	–
	To be provided externally	A	1 A fuse	–	Supplied with 2.5 A fuse

Characteristics of “Com-Z” link with the smart relay

Type of connector		Specific to Zelio
Type of link		Specific Zelio communication protocol
Compatibility		Only with Zelio Logic smart relays SR● B●●●●● and SR2 E●●●●● version V3.1 and above
Isolation of “Com-Z” connector	From the “Com-M” connector	By ~ 1780 V opto-coupler
	From the +/- supply terminals	By ~ 1780 V opto-coupler

Characteristics of “Com-M” link with the Modem

Type of connector		Specific to Zelio
Type of link with SR2 CBL07		RS 232 serial (included with the communication interface)
Compatibility	Analog PSTN modem	AT commands
	GSM Modem	AT commands
Isolation of “Com-M” connector	From the Modem	By the cable SR2 CBL07
	From the +/- supply terminals	By the cable SR2 CBL07

Processing characteristics

Data saved by the interface	Messages		Up to 28 messages
	Telephone/e-mail details and recipient profiles		1 to 10 recipients (telephone numbers and/or e-mail addresses) per message
	Date and time		Dating of messages to be sent
	Discrete and digital values		Backup of values when the message activation condition is triggered.
Backup of data to be sent			Flash memory

Zelio® Logic 2

Programmable Smart Relays

Modem communication interface

523083



SR2 COM01

523086



SR2 CBL07

Modem communication interface

Description	Supply voltage	Reference	Weight kg
Communication interface (including cable SR2 CBL07)	~ 12 to 24 V	SR2 COM01 (1)	0.200

Software

Description	Application Compatibility	Medium	Reference	Weight kg
Zelio Logic Alarm	PC Microsoft® Windows 98, NT4, 2000 and XP	CD-ROM	SR2 SFT02	0.200

Connection accessories

Description	Application	Length	Reference	Weight kg
		m		
Connection cables	SUB-D9/SUB-D9 connectors Between modem and PC	1.8	SR1 CBL03	0.110
	Specific Zelio/SUB-D9 connector Between communication interface and modem	0.5	SR2 CBL07 (2)	0.050

(1) Can only be used with "Zelio Soft 2" software version V3.1 or above.

(2) Spare part (cable included with communication interface SR2 COM01).

Zelio[®] Logic 2

Programmable Smart Relays

Modem communication interface

Communication interface

SR2 COM01

Dual Dimensions $\frac{\text{mm}}{\text{inches}}$

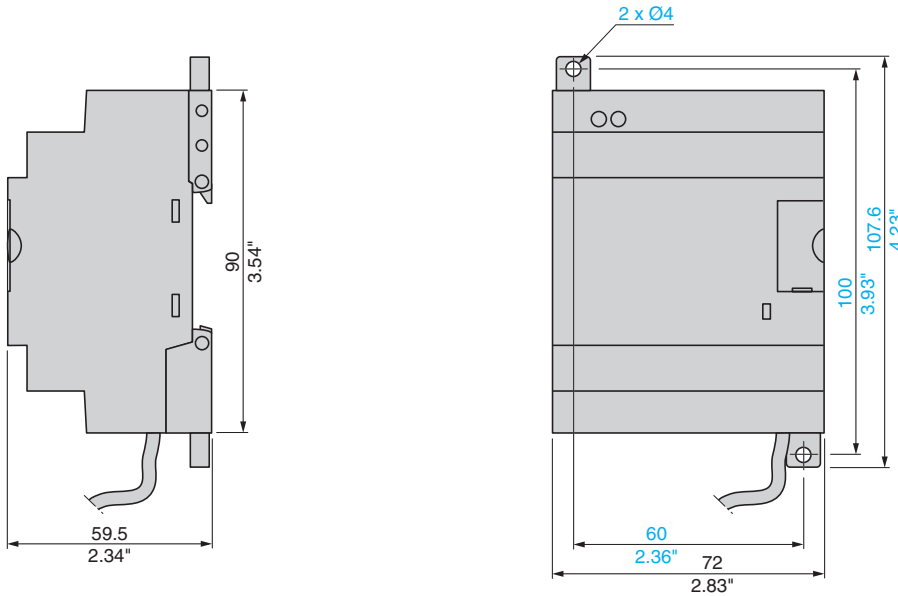

Zelio® Logic 2

Programmable Smart Relays

Modem communication interface

Connection schemes for connecting communication interface SR2 COM01 to the smart relay and the Modem

SR● B●●1JD, SR● B●●●BD et SR2 E●●●BD

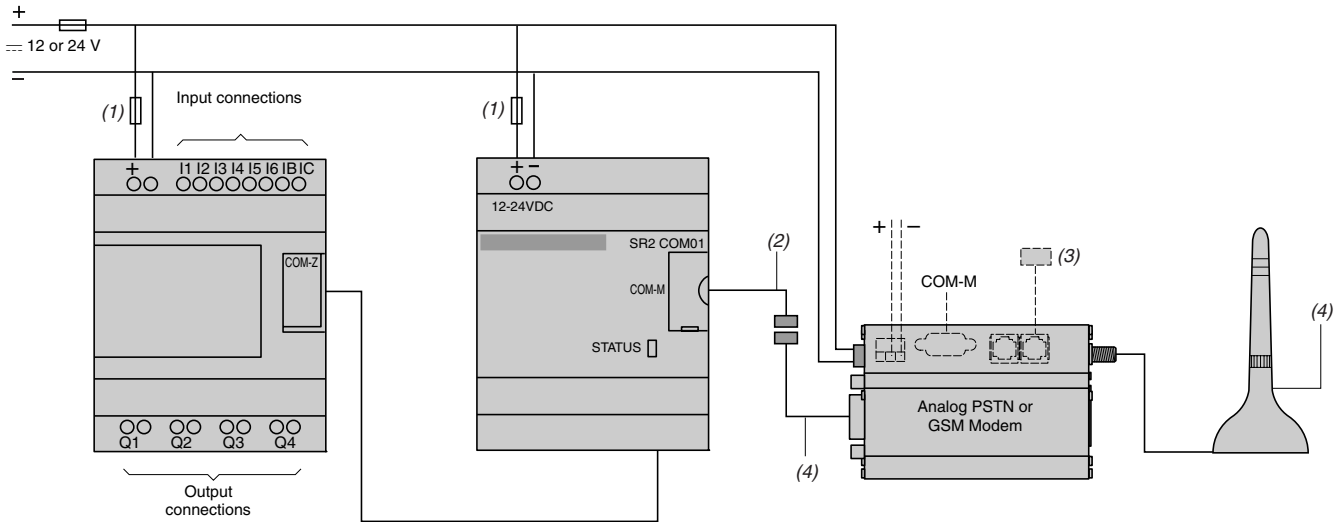

- (1) 1 A quick-blow fuse.
- (2) Cable included with Modem communication interface SR2 COM01.
- (3) Cable for connection to the Transmission network (included with analog PSTN modem).
- (4) Antenna and cable included with GSM Modem.

SR● B●●1B, SR● B●●●FU, SR2 E●●●B et SR2 E●●●FU

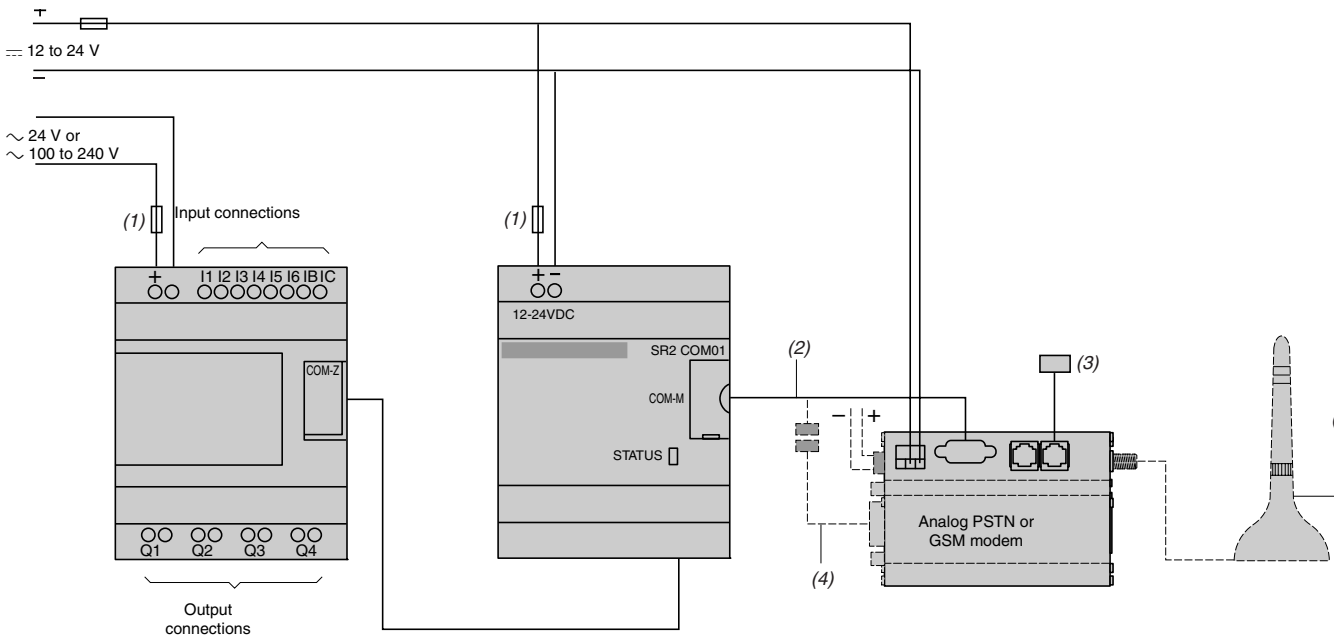

- (1) 1 A quick-blow fuse.
- (2) Cable included with Modem communication interface SR2 COM01.
- (3) Cable for connection to the Transmission network (included with analog PSTN modem).
- (4) Antenna and cable included with GSM Modem.

Connection schemes for connecting the PC to the Modem

For PCs without an internal Modem.

Analog PSTN Modem

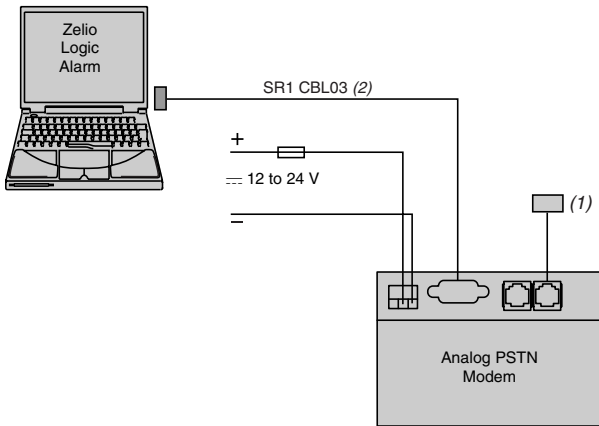

(1) Cable for connection to the Transmission network (included with analog PSTN modem).
 (2) To be ordered separately.

GSM Modem

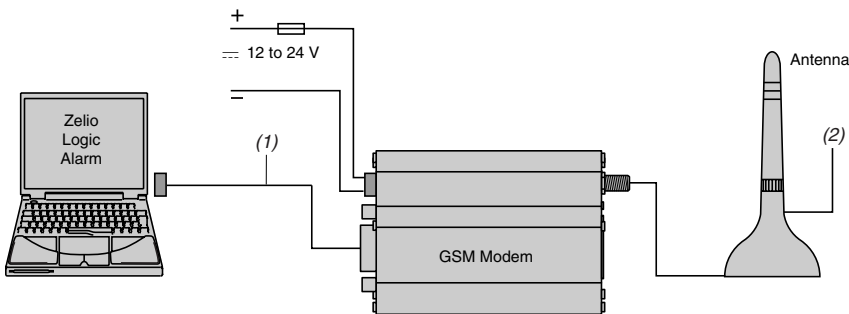

(1) Cable included with the Modem, length 50 cm (19.7"). The cable length can be increased using SR1 CBL03, 1,8 m (5.9 ft.).
 (2) Antenna and cable included with GSM Modem.

Power supplies

Power supplies for d.c. control circuits Phaseo® modular regulated power supplies

Modular switch mode power supplies ABL 7RM

The ABL 7RM range of power supplies is designed to provide the d.c. voltage necessary for the control circuits of automation system equipment. Comprising 3 products, this range meets the needs encountered in industrial, commercial and residential applications. These single-phase, modular, electronic switch mode power supplies provide a quality of output current which is suitable for the loads supplied and compatible with the Zelio Logic 2 programmable smart relays range, making them ideal partners. Clear guidelines are given on selecting the upstream protection devices which are often used with them, and thus a comprehensive solution is provided that can be used in total safety.

These switch mode power supplies are totally electronic and regulated. The use of electronics makes it possible to significantly improve the performance of these power supplies, which offer:

- very compact size,
- integrated overload, short-circuit, overvoltage and undervoltage protection,
- a very wide range of permissible input voltages, without any adjustment,
- a high degree of output voltage stability,
- good performance,
- considerably reduced weight,
- a modular format allowing integration into panels.

Phaseo power supplies deliver a voltage which is precise to 3%, whatever the load and whatever the type of mains supply, within a range of 85 to 264 V for single-phase. Conforming to IEC standards and UL and CSA certified, they are suitable for universal use. The inclusion of overload and short-circuit protection makes downstream protection unnecessary if discrimination is not required.

All the products are fitted with an output voltage adjustment potentiometer in order to be able to compensate for any line voltage drops in installations with long cable runs. These power supplies are designed for direct mounting on 35 mm (1.38") and 75 mm (2.95") rails, or on a mounting plate using the retractable mounting feet.

These power supplies are single-phase and three references are available:

- ABL 7RM2401 (24 V \Rightarrow 1.3 A),
- ABL 7RM24025 (24 V \Rightarrow 2.5 A),
- ABL 7RM1202 (12 V \Rightarrow 1.9 A).

Description

ABL 7RM2401
ABL 7RM1202

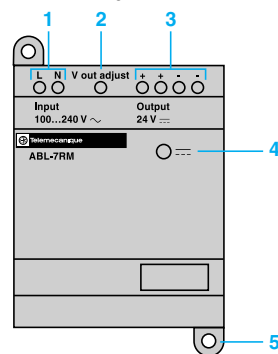

ABL 7RM24025

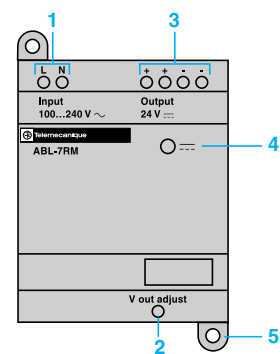

- 1 2.5 mm² (# 14 AWG) screw terminals for connection of the incoming a.c. supply voltage.
- 2 Output voltage adjustment potentiometer.
- 3 2.5 mm² (# 14 AWG) screw terminals for connection of the output voltage.
- 4 LED indicating presence of the d.c. output voltage.
- 5 Retractable mounting feet.

Technical characteristics			
Power supply type			ABL 7RM1202 ABL 7RM2401 ABL 7RM24025
Certifications		UL - CSA - TÜV	
Conforming to standards	Safety	IEC/EN 60950-1 - IEC/EN 61131-2/A11	
	EMC	IEC/EN 61000-6-2 (IEC/EN 61000-6-1), IEC/EN 61000-6-3	
Input circuit			
LED indication		No	
Input voltage	Nominal values	V	~ 100 to 240
	Permissible values	V	~ 85 to 264
	Permissible frequencies	Hz	47 to 63
	Efficiency at nominal load		> 80%
	Current consumption	A	0.5 (100 V)/0.3 (240 V) 0.6 (100 V)/0.4 (240 V) 1.2 (120 V)/0.7 (240 V)
	Current at switch-on	A	< 20
	Power factor		0.6
Output circuit			
LED indication		Green LED	
Nominal output voltage		V	--- 12 --- 24
Nominal output current		A	1.9 1.3 2.5
Precision	Output voltage		Adjustable from 100 to 120%
	Line and load regulation		± 4 % ± 3 %
	Residual ripple - interference	mV	200 250 200
Micro-breaks	Holding time for I max and Ue min	ms	> 10
Protection	Against short-circuits		Permanent/Thermal protection
	Against overcurrent, cold state		< 1.7 In < 1.6 In < 1.4 In
	Against overvoltage	V	< 10.5 < 19
Operating characteristics			
Connections	Input	mm ² (AWG)	1 x 2.5 (#14 AWG) or 2 x 1.5 (#16 AWG) screw terminals
	Output	mm ² (AWG)	1 x 2.5 (#14 AWG) or 2 x 1.5 (#16 AWG) screw terminals
Environment	Storage temperature	°C (°F)	- 25 to + 70 (-13 to + 158) - 40 to + 70 (-40 to +158)
	Operating temperature	°C (°F)	- 20 to + 55 (-4 to + 131)
	Maximum relative humidity		95 %
	Degree of protection		IP 20
	Vibration		IEC/EN 61131-2, IEC/EN 60068-2-6 test Fc
Operating position			Vertical
Connections	Series		No
	Parallel		Yes (same references)
Dielectric strength	Input/output		3000 Vac/50 Hz/1 min
Protection class conforming to VDE 0106 1			Class II without PE
Input fuse incorporated			Yes (not interchangeable)
Emissions	Conducted/radiated		IEC/EN 61000-6-3, EN 55011, EN 55022 Cl:B
Immunity	Electrostatic discharge		IEC/EN 61000-6-2 (generic standard), IEC/EN 61000-4-2 (4 kV contact/8 kV air)
	Electromagnetic		IEC/EN 61000-4-3 level 3 (10 V/m)
	Conducted interference		IEC/EN 61000-4-4 level 3 (2 kV), IEC/EN 61000-4-6 (10 V)
	Mains interference		IEC/EN 61000-4-11

Output characteristics

Exceeding the nominal power (only applicable to ABL 7RM1202 and ABL 7RM2401)

The ambient temperature is a determining factor which limits the power that an electronic power supply can deliver continuously. If the temperature around the electronic components is too high, their life will be significantly reduced. Conversely, a power supply can deliver more than its nominal power if the ambient temperature remains well below the nominal operating temperature.

The maximum ambient temperature for Phaseo power supplies is 55 °C (131 °F). Below this temperature, uprating is possible up to 110% of the nominal power. The graph below shows the power (in relation to the nominal power) that the power supply can deliver continuously, according to the ambient temperature. Power supply ABL 7RM24025 cannot exceed the nominal power of 60 W.

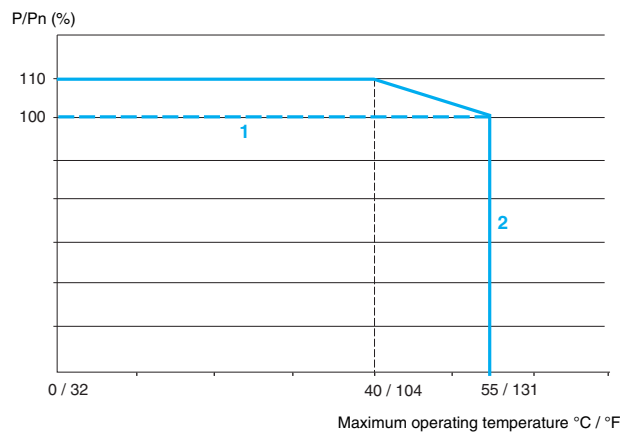

- 1 ABL 7RM24025
- 2 ABL 7RM1202 and ABL 7RM2401

Selection

Upstream protection of power supplies

Type of mains supply Type of protection	~ 100 V single-phase			~ 240 V single-phase		
	Thermal-magnetic circuit-breaker		Fuse gG	Thermal-magnetic circuit-breaker		Fuse, gG
	GB2 (UL/IEC)	C60N (IEC) C60N (UL)		GB2 (UL/IEC)	C60N (IEC) C60N (UL)	
ABL 7RM1202	GB2 ●●06	24580 24516	1 A	GB2 ●●05	24494 24516	1 A
ABL 7RM2401	GB2 ●●06	24580 24516	1 A	GB2 ●●06	24580 24516	1 A
ABL 7RM24025	GB2 ●●08	24582 24518	3 A	GB2 ●●08	24582 24518	3 A

Schemes

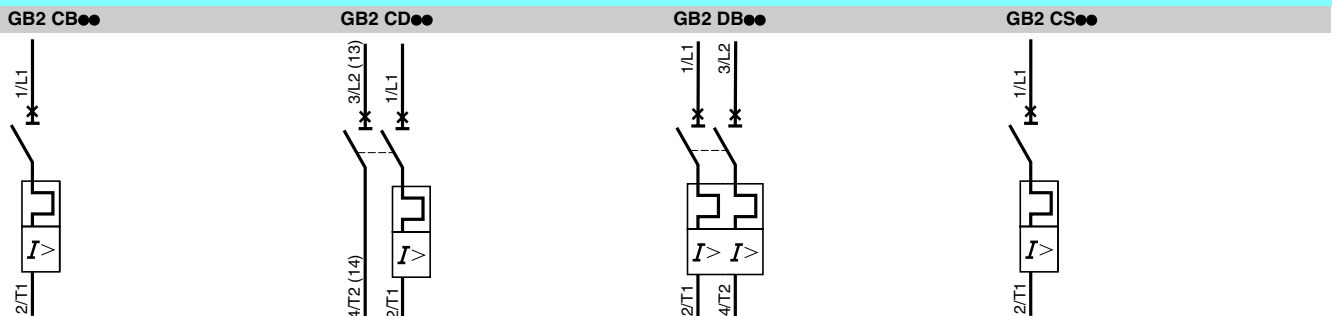

Power supplies

Power supplies for d.c. control circuits
Phaseo® modular regulated power supplies

Modular regulated switch mode power supplies ABL 7RM (1)



ABL 7RM

Mains input voltage 47 to 63 Hz	Output voltage	Nominal power	Nominal current	Auto-protect reset	Reference	Weight
V	V	W	A			kg
100 to 240 Single-phase wide range	12	22	1.9	Auto	ABL 7RM1202	0.180
	24	30	1.3	Auto	ABL 7RM2401	0.182
		60	2.5	Auto	ABL 7RM24025	0.255

(1) For additional products, please contact your local Schneider Electric representative.

Dimensions

Power supply ABL 7RM●●●●

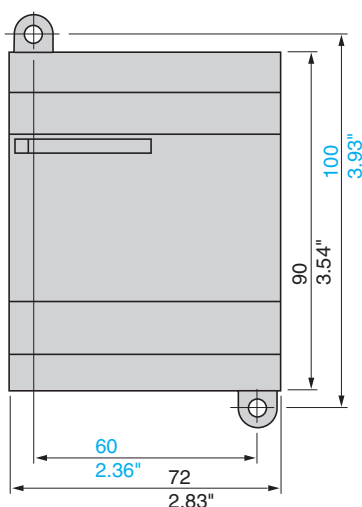
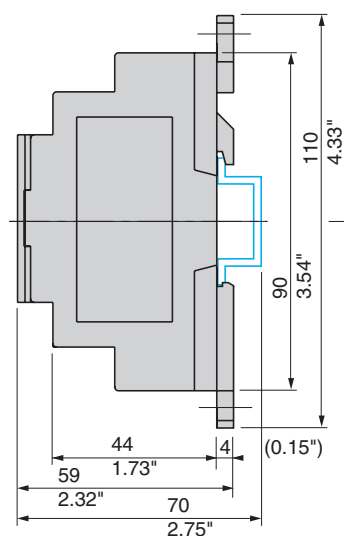

Dual Dimensions $\frac{\text{mm}}{\text{inches}}$

Scheme

ABL 7RM●●●●

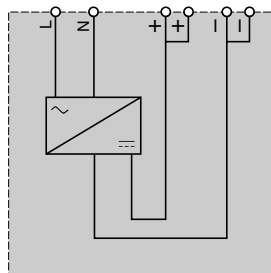

14210.....	22	SR3 XT101JD	21
14211.....	22	SR3 XT141B	21
170 XTS 04100	31	SR3 XT141BD	21
ABL 7RM1202	45	SR3 XT141FU	21
ABL 7RM2401	45	SR3 XT141JD	21
ABL 7RM24025	45	SR3 XT43BD (1) (5)	21
See page 45	22	SR3 XT61B	21
SR1 CBL03	38	SR3 XT61BD	21
SR2 MEM01	22	SR3 XT61FU	21
SR2 MEM02	22	SR3 XT61JD	21
SR2 A101BD (1)	20	VW3 A8 306TF03	31
SR2 A101FU (1)	20	VW3 A8 306TF10	31
SR2 A201BD (1)	20	VW3 A8306R03	31
SR2 A201FU (1)	20	VW3 A8306R10	31
SR2 B121B	20	VW3 A8306R30	31
SR2 B121BD	20		
SR2 B121FU	20		
SR2 B121JD	20		
SR2 B122BD	20		
SR2 B201B	20		
SR2 B201BD	20		
SR2 B201FU	20		
SR2 B201JD	20		
SR2 B202BD	20		
SR2 CBL01	22		
SR2 CBL06	22		
SR2 CBL07	38		
SR2 COM01	38		
SR2 D101BD (1)	20		
SR2 D101FU (1)	20		
SR2 D201BD (1)	20		
SR2 D201FU (1)	20		
SR2 E121B	20		
SR2 E121BD	20		
SR2 E121FU	20		
SR2 E201B	20		
SR2 E201BD	20		
SR2 E201FU	20		
SR2 MAN01DE	22		
SR2 MAN01EN	22		
SR2 MAN01ES	22		
SR2 MAN01FR	22		
SR2 MAN01IT	22		
SR2 MAN01P0	22		
SR2 PACK2BD	20		
SR2 PACK2FU	20		
SR2 PACKBD	20		
SR2 PACKFU	20		
SR2 SFT01	22		
SR2 SFT02	38		
SR2 USB01	22		
SR3 MBU01BD	31		
SR3 B101B	21		
SR3 B101BD	21		
SR3 B101FU	21		
SR3 B102BD	21		
SR3 B261B	21		
SR3 B261BD	21		
SR3 B261FU	21		
SR3 B261JD (1)	21		
SR3 B262BD	21		
SR3 PACK2BD	21		
SR3 PACK2FU	21		
SR3 PACKBD	21		
SR3 PACKFU	21		
SR3 XT101B	21		
SR3 XT101BD	21		
SR3 XT101FU	21		

The efficiency of Telemecanique® branded *solutions*

Used in combination, Telemecanique products provide quality solutions, meeting all your **Automation & Control** applications requirements.



A worldwide presence

Constantly available

- More than 5 000 points of sale in 130 countries.
- You can be sure to find the range of products that are right for you and which complies fully with the standards in the country where they are used.

Technical assistance wherever you are

- Our technicians are at your disposal to assist you in finding the optimum solution for your particular needs.
- Schneider Electric provides you with all necessary technical assistance, throughout the world.



Find out more about Zelio Logic
for your applications with the “discovery” packs:

- pack contains:
1 product, 1 connecting cable and 1 software CD
- available in 24 Vdc or 100...240Vac



Schneider Electric

Head office
Schneider Electric
North American Operation Division
1415 South Roselle Road
Palatine, IL 60064
TEL 847-397-2600

<http://www.us.telemecanique.com>
<http://www.us.schneider-electric.com>

ART. 808501

DIA3ED2051002EN-US © 2007 Schneider Electric. All Rights Reserved.

Simply Smart !

Owing to changes in standards and equipment, the characteristics given in the text and images in this document are not binding us until they have been confirmed with us.

Production : Schneider Electric Industries
Photos : Schneider Electric Industries
Printed by :



January 2007