



FIBER OPTIC CABLING SYSTEM SOLUTIONS
BEYOND THE GLASS™



PANDUIT is a Technology Developer Partner for Storage Networking Hardware.

Bandwidth Requirements Push Fiber Optic Solutions

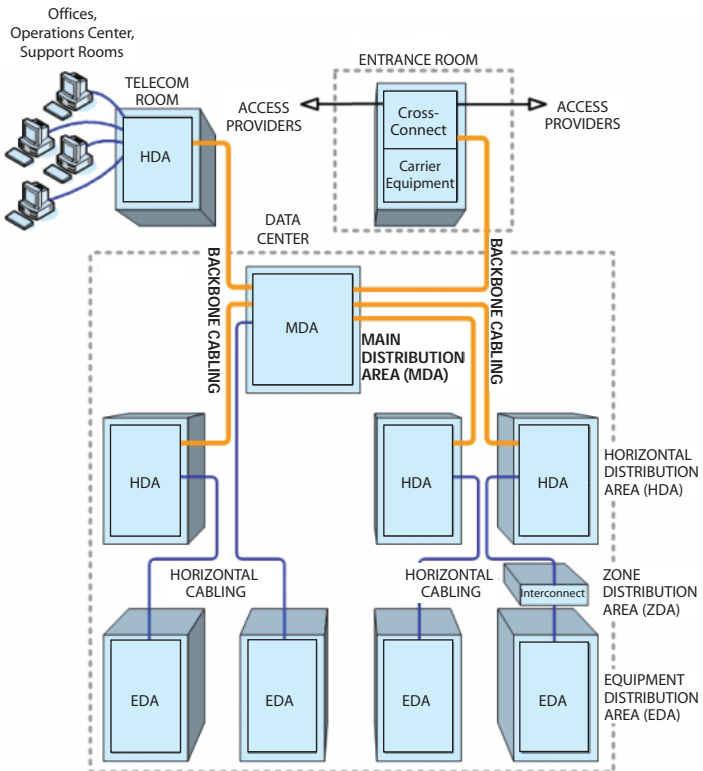

Data Center Architectures Require High Bandwidth Fiber

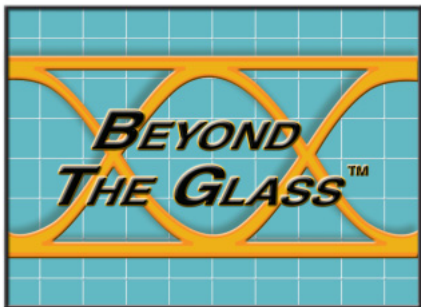

Advanced applications, including voice and data convergence and storage area networking, are taxing today's structured cabling infrastructure. High-bandwidth networking was historically limited to long haul telecom networks and premise backbone systems. Today, convergence is extending the optical network into the domain of the user, demanding higher bandwidth solutions enterprise wide.

For information transfer between workstations, telecommunications rooms, data centers and inter-building networks that require high-bandwidth, security and immunity to noise, a fiber optic infrastructure offers the perfect choice. Emerging applications require technologies that provide high data rate capabilities and reliability, as well as ease of deployment and flexibility. High density, rapid deployment, and certified systems are key priorities in mission critical network applications. In concert, network designers expect fiber optic systems installed today to be scalable to support the user needs of tomorrow. Carefully planned optical fiber network solutions deliver lower cost of ownership, consistent high performance, and maximum up-time.

PANDUIT, the world leader in structured cabling solutions, is the one-source supplier for end-to-end fiber optic cabling systems. In response to market needs, *PANDUIT* focuses on delivering leading-edge *BEYOND THE GLASS™* Fiber Optic Solutions that meet the bandwidth requirements for today's deployments and provide a migration path for the applications of tomorrow.

BEYOND THE GLASS™ Solutions deliver unmatched reliability, highest performance, and greatest flexibility by combining:

- **Design Excellence**
- **Application and Technology Leadership**
- **End-to-End Fiber Optic Solutions**
- **Fiber Optic Product Innovations**

Design Excellence

System designers, installers and end users count on *PANDUIT* to lead the way in delivering next generation optical fiber cabling systems to market. Leading with *BEYOND THE GLASS™* Design Excellence, a revolutionary concept that pushes fiber technology beyond design and manufacturing of the “glass” itself, *PANDUIT* fiber research, product development, and manufacturing expertise assures consistent high performance and reliability throughout the structured cabling system.

BEYOND THE GLASS™ initiatives encompass in-depth research and analysis to determine actual, real-world performance requirements of the optical network and all factors that may degrade system performance. From this analysis, *PANDUIT* Laboratories’ engineers map out recommended product design and manufacturing process enhancements and integrate them into each product solution.

The result of this comprehensive research and development program is a reliable end-to-end system configuration built on the sum of interoperable fiber optic components. *PANDUIT* focuses on system level functional Bit Error Rate (BER) testing as the true determination of channel performance, and considers BER testing as the evaluation method most relevant to the reliable operation of 10 Gigabit Networks.

BEYOND THE GLASS™ Design Excellence doesn’t just mean that *PANDUIT* structured cabling systems exceed industry standards; it assures the highest optical performance and reliability for each specified application and environment.



Advanced Design Tools
Speed Product Introduction

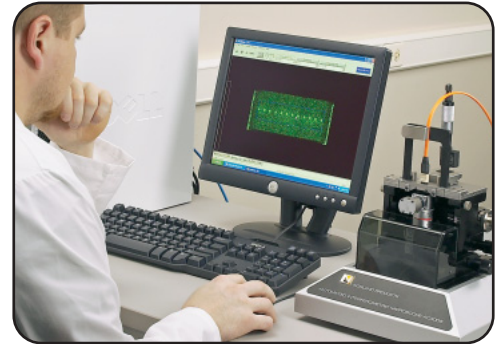

Enhanced End Face Geometry Testing
Verifies Performance Compliance

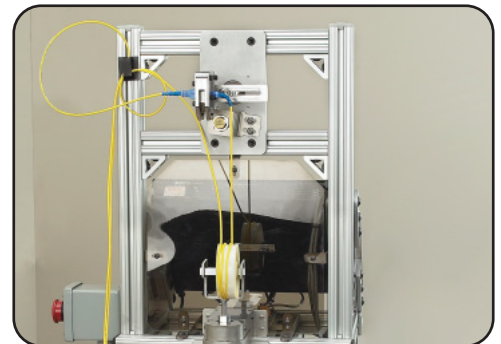

Mechanical Stress Testing
Ensures Product Reliability

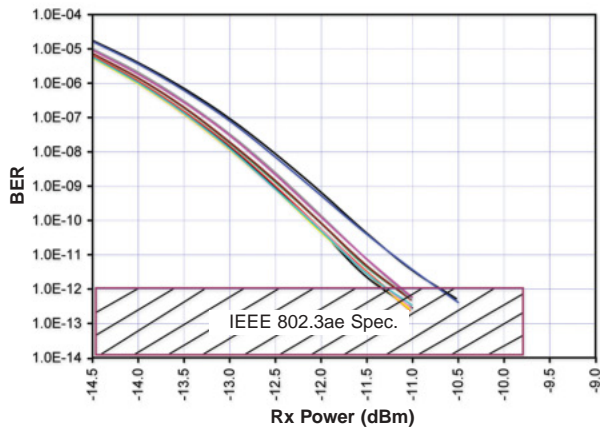

300M 10Gig™ Channel Verification

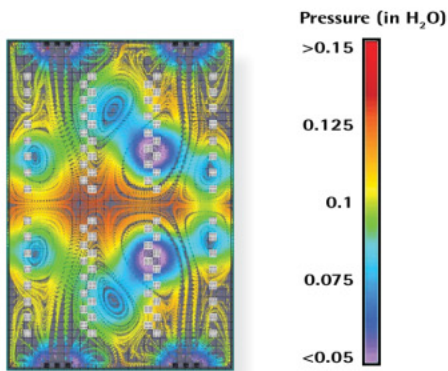

CFD Analysis Map



Data Center Solutions

Application and Technology Leadership

Fiber optic applications in enterprise markets are widespread, starting from the entrance and extending to the workstation. *PANDUIT* offers a comprehensive suite of solutions designed and built to perform in the most challenging environments for maximum system reliability.

PANDUIT Laboratories' advancing fiber optic technologies:

- **10Gb/s Channel Test Development** – Fiber BER functional channel testing and research aimed at certifying fiber components
- **Material Research and Analysis** – Dedicated research engineers, subject matter experts, and advanced Analytical Services Lab
- **Finite Element Analysis, Mold Flow, Computational Fluid Dynamics (CFD)** – Advanced analytical tools to speed product development and deployment
- **Standards Committee Participation** – Participation and leadership in North American and International standards forming bodies

PANDUIT solutions for evolving application needs:

- **Data Center and Storage Networks** require standards-based 10 Gigabit Systems that are both reliable and cost-effective; this becomes essential in support of today's critical applications, including Web Hosting, Business Management, Data Storage and E-Commerce
- **Backbone Cabling** carries over 80% of the network traffic; this infrastructure asset must be designed to meet current and future demands of this mission critical portion of the network
- **Fiber-to-the-Zone** deployments necessitate flexible configurations delivering high bandwidth and long reach that are easily integrated into premise or data center environments; fiber-to-the-zone applications are designed to give the user more access to network capability
- **Fiber-to-the-Desk** is a highly effective means of providing high-bandwidth all the way to the workstation; high-end workstations rely on fiber systems to support streaming video, computer animation, scientific modeling and medical imaging

End-to-End Fiber Optic Solutions

An end-to-end fiber optic solution is more than just a bill of materials. *PANDUIT* is a global leader delivering complete solutions with distinct advantages over traditional fiber component manufacturers. These advantages include *BEYOND THE GLASS™* design excellence, application and technology leadership, a comprehensive portfolio of innovative fiber optic cabling products and unmatched customer support.

The full breadth of *PANDUIT* fiber optic solutions complements and completes our line of integrated structured cabling systems that include fiber and copper connectivity, rack and cable management, outlets and surface raceway, and labeling and administration solutions. These systems are designed specifically to support leading edge markets, including finance, education, government and healthcare. From the entrance facility to the workstation, *PANDUIT* provides a full portfolio of solutions for campus and premise environments.

PANDUIT solutions support the multi-gigabit data rates of today by maximizing performance, modularity, flexibility and scalability for architectures and applications of tomorrow.

- **Fiber optic solutions** include cable, connectors, termination tooling, adapters, adapter modules, adapter panels, rack mount and wall mount enclosures, splice trays, pre-terminated cassettes, patch cords, cable assemblies and fiber routing
- **Global sales force** of highly qualified industry experts provide professional consultation and guidance to local, regional, and multi-national organizations
- **Global network of *PANDUIT* warehouses and distributors** provide world wide product availability for consistent, rapid solution deployment
- ***PANDUIT CERTIFICATION PLUS*SM System Warranty** ensures installed structured cabling system performance*
- ***PANDUIT* Certified Designer (PCD) Program** provides designers with the tools and training needed to deliver optimum solutions
- ***PANDUIT* Certified Installer (PCI) Program** ensures installers deploy your network infrastructure properly and efficiently
- **Industry leading customer service** provides world-class support during system installation and maintenance, plus seamless consultation with *PANDUIT* subject matter experts

* To be eligible for the *CERTIFICATION PLUS*SM System Warranty, the system must be installed by a *PANDUIT* Certified Installer and be registered by *PANDUIT*. The *CERTIFICATION PLUS*SM System Warranty is subject to various terms, conditions, and limitations. Go to www.panduit.com/warranty to review the *CERTIFICATION PLUS*SM System Warranty.



End-to-End Fiber Optic Solutions

1 OPTI-CORE® Fiber Optic Cable Solutions



Distribution, Interconnect and Indoor/Outdoor Fiber Optic Cable in OM1, OM2, OM3 and OS1 fiber; 10Gig™ Fiber Optic Cable features the highest quality laser optimized OM3 fiber

2 PANDUIT Fiber Optic Connector Solutions



LC, SC, ST and FJ® connector types; singlemode or multimode, and simplex or duplex, connectors are available in field polish, and OPTICAM™ and OPTI-CRIMP® pre-polished termination designs

3 OPTI-CORE® Fiber Optic Patch Cords and Cable Assembly Solutions



OM1, OM2, OM3 and OS1 simplex and duplex patch cords and cable assemblies in LC, SC, ST, MTP* and FJ® connectivity types in a variety of lengths; 10Gig™ Solutions feature laser optimized OM3 fiber

4 OPTICOM® Rack and Wall Mount Enclosure, Fiber Adapter Panel and Pre-Terminated Cassette Solutions



OPTICOM® Rack and Wall Mount Enclosures for regular to high-density applications; OPTICOM® Fiber Adapter Panels (FAPs) and QUICKNET™ Pre-Terminated MTP* Cassettes are pre-loaded with LC, SC, ST and MT-RJ adapters

5 MINI-COM® Fiber Optic Adapter Module and Fiber Adapter Solutions



MINI-COM® Adapter Modules in LC, SC, ST, MT-RJ, FC and MPO variations; LC and SC simplex and duplex adapters



*MTP is a registered trademark of US Conec Ltd.



6 PANDUIT Cable Management Rack System Solutions



PATCHRUNNER™, *NETRUNNER™*, and *NETFRAME®* Cable Management Rack Systems provide a complete system solution to manage, protect, and showcase equipment and structured cabling investments

7 FIBERRUNNER® Routing Solutions



The *FIBERRUNNER®* Routing System is comprised of channel, couplers, fittings and brackets designed to segregate, route, and protect fiber optic cabling

8 PANZONE® Zone Cabling Solutions



PANZONE® Zone Cabling products provide a high capacity main cable distribution point in the floor, ceiling or on the wall for a particular zone to feed workstation outlets with short cable runs for voice, data, and video connections

9 MINI-COM® Outlet and PAN-WAY® Surface Raceway Solutions



Broad range of *MINI-COM®* Faceplates and Surface Mount Boxes, and *PAN-WAY®* Surface Raceway products in many styles and port configurations accept *MINI-COM®* Modules for modularity and flexibility

10 PANDUIT Labeling and Administration Solutions



Full line of labeling products, software, and printers to properly identify network elements; identification solutions are available to comply with applicable global standards requirements

For full PANDUIT product offering request *PAN-NET® Network Solutions Catalog, SA-NCCB14*.

For service and technical support, call 800-777-3300 (outside the U.S. and Canada, see back cover).

1 OPTI-CORE® Fiber Optic Cable Solutions

Extend life cycle and reduce cost of ownership – All OPTI-CORE® Fiber Optic Cable meets or exceeds applicable global standards for optical performance and cable construction, such as Riser (OFNR), Plenum, (OFNP) and Low Smoke Zero Halogen (LSZH).

Support and extend infrastructure life cycle – OPTI-CORE® Distribution, Interconnect, and Indoor/Outdoor Fiber Optic Cable is available in multimode (OM1, OM2, OM3) and singlemode (OS1) fiber in multiple fiber counts.

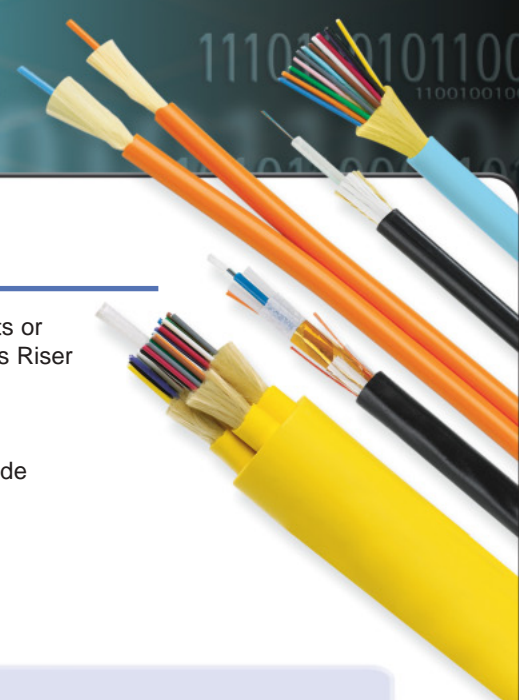

OPTI-CORE® 10GIG™ Technology

Highest Quality Laser Optimized OM3 Fiber Further Extends Life Cycle and Reduces Cost of Ownership

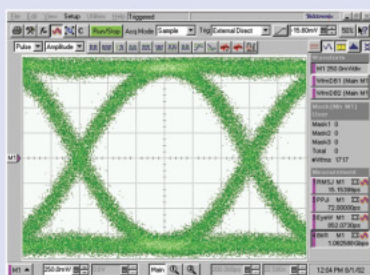

- All OPTI-CORE® 10GIG™ Fiber Optic Cable features the highest quality laser optimized OM3 fiber to support network transmission speeds up to 10Gb/s for link lengths up to 300M with an 850nm source per IEEE 802.3ae 10GbE Standard
- Maintains compatibility with existing 50µm multimode systems to provide a simple upgrade path for future bandwidth requirements without media retrofit
- Application specific 10Gb/s fiber solutions (based on reach capability) reduce media cost up to 20%

2 PANDUIT Fiber Optic Connector Solutions

Connector selection meets network requirements – PANDUIT Fiber Optic Connectors are available in LC, SC, ST and FJ® connector types, singlemode or multimode, and simplex or duplex to fit specific network density and transmission speed requirements.

Termination selection meets installation preferences – PANDUIT Fiber Optic Connectors are available in field polish and OPTICAM™ pre-polished cam termination designs to provide installation flexibility.

Longer life cycle, improved network reliability – Zirconia ceramic ferrules provide the highest durability for repeated matings; SC and LC Connectors provide non-optical disconnect to maintain data transmission under tensile loads for jacketed cable.

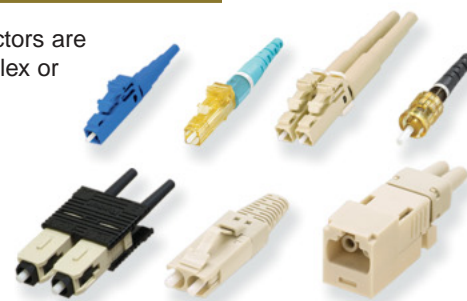

Innovative OPTICAM™ Technology

LC, SC, and ST OPTICAM™ Pre-Polished Cam Connectors Provide Faster Field Terminations and Yield Rates Approaching 100%

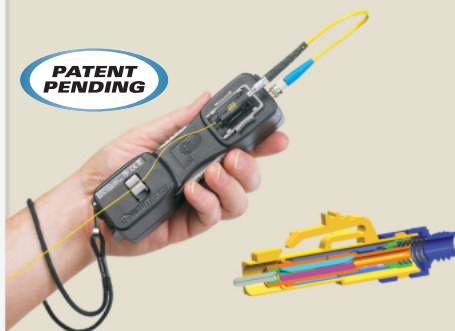

- Factory pre-polished fiber stub endface eliminates inconsistent, time consuming field polishing to reduce installation costs, labor, and the number of tools required; less than half the termination time of conventional field polish connectors
- Patent pending dual cam design secures both the fiber and the buffer in one action and allows up to two re-terminations to ensure consistent termination result
- Universal termination tool with integrated visual fault locator offers visual indication of proper termination for OPTICAM™ Connectors to virtually eliminate operator error
- SC and ST OPTICAM™ Connectors are available with zirconia ceramic or polymer ferrules to meet a variety of application requirements

3 **OPTI-CORE® Fiber Optic Patch Cord and Cable Assembly Solutions**

System solution flexibility – OPTI-CORE® Patch Cords and Cable Assemblies are available in LC, SC, ST, MTP* and FJ® connector combinations, singlemode or multimode, simplex or duplex, in a variety of lengths, to support your solution preference.

Assured performance and lifetime traceability of test data – All OPTI-CORE® Patch Cords and Cable Assemblies are factory terminated and 100% tested for insertion loss; singlemode patch cords are also 100% tested for return loss and endface geometry is 100% inspected.

Support and extend infrastructure life cycle – All OPTI-CORE® 10GIG™ Patch Cords and Cable Assemblies feature laser optimized OM3 fiber and are tested per IEEE 802.3ae 10GbE for link lengths up to 300M at 850nm to support 10Gb/s network application requirements.



Innovative MTP* Proprietary Polishing Technology

Provides Certified 10 Gigabit Ethernet Performance

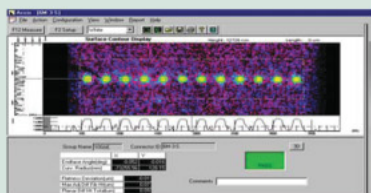

- Extensive research towards obtaining a consistent endface geometry in support of the return loss requirements for IEEE 802.3.ae
- MTP* ends are polished and 100% tested by PANDUIT to minimize insertion loss and maximize return loss performance

4 **OPTICOM® Rack and Wall Mount Enclosure, Fiber Adapter Panel, and Pre-Terminated Cassette Solutions**

Maximize valuable space and ensure fiber integrity – OPTICOM® Rack and Wall Mount Enclosures organize, manage, and protect fiber connections and splices in compact high-density applications.

Lowest installed cost – OPTICOM® Enclosures enable fast and easy field installation of system components.

System modularity and scalability – OPTICOM® Fiber Adapter Panels (FAPs) are pre-loaded with simplex or duplex LC, SC, ST or MT-RJ adapters for singlemode or multimode fiber, and snap quickly into the front of OPTICOM® Enclosures for upgrades and future network growth.

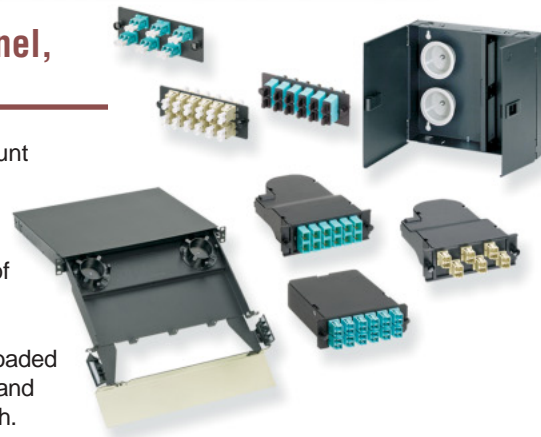

Innovative QUICKNET™ Technology

Delivers Optimum High-Density 10 Gigabit Performance

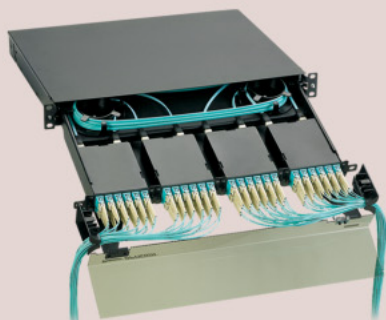

- Modular QUICKNET™ Pre-Terminated Cassettes provide a scalable solution for the lowest total cost of ownership
- 100% tested to deliver verified optical performance and reliability for improved network integrity; optimized cassettes are available to deliver maximum insertion loss of 0.5dB per channel, allowing more connectivity and longer reach network segments to be deployed
- Enables quick, plug-in network deployment of up to 96 fiber connections in a single rack space with superior cable access and cable management capabilities; installation in less than 20% of the time of conventional field polish connectors with distribution cables

*MTP is a registered trademark of US Conec Ltd.

5 **MINI-COM®** Fiber Optic Adapter Module and Fiber Optic Adapter Solutions

Installation flexibility – *MINI-COM®* Adapter Modules are available in LC, SC, ST, MT-RJ, FC and MPO connectivity types, singlemode or multimode, simplex or duplex, and split sleeve materials to fit specific network requirements.

System modularity – *MINI-COM®* Adapter Modules are interchangeable and allow fast, easy system upgrades or modifications within *MINI-COM®* Modular Patch Panels, Faceplates and Surface Mount Boxes to extend system life cycle.

Color-coding for identification and network segregation – LC and SC Adapters are molded in Electric Ivory for multimode, Blue for singlemode, Aqua for 10Gig™ and Green for APC; *MINI-COM®* Modules are also available in multiple colors.

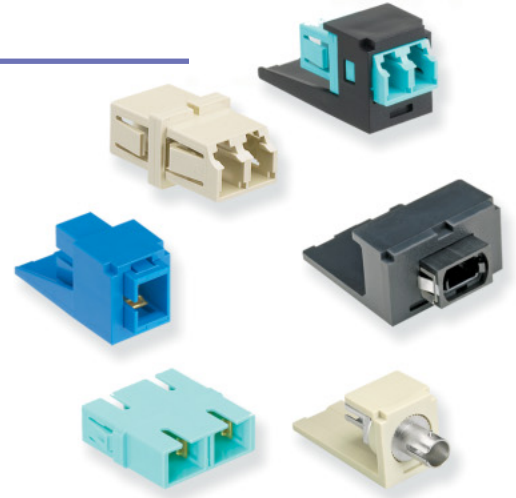

6 **PANDUIT** Cable Management Rack System Solutions

Optimum management of network cabling – The *PATCHRUNNER™* Cable Management System features cable management fingers aligned at each rack unit to organize and support fiber cables as they transition to the vertical pathway.

Advanced protection for reliable system performance – The *PATCHRUNNER™* Cable Management System features bend radius-optimized surfaces to protect fiber cabling to ensure network performance and reliability.

A showcase for network technology – The *PATCHRUNNER™* Cable Management System promotes organized cable management and features full-length dual-hinging doors to provide a clean aesthetic finish and easy access to the vertical pathways.



7

FIBERRUNNER® Routing Solutions

Fast, easy MACs – *FIBERRUNNER®* Routing Solutions install quickly and allow easy access for future cabling revisions and network additions.

Versatility – *FIBERRUNNER®* Routing Solutions can be configured to meet virtually any network design.

Maximize long-term performance – *FIBERRUNNER®* Routing Solutions maintain integrity of fiber optic cabling routed to and between the MDA and equipment cabinets in the data center.



8 PANZONE® Zone Cabling Solutions

High capacity, cost effective main cable zone distribution point – PANZONE® Zone Cabling products serve as high capacity distribution points, feeding workstation outlets with short cable runs for voice data and video connections.

Reduce downtime – PANZONE® Zone Cabling products provide the ability to make quick and easy MACs.

System modularity and scalability – PANZONE® Zone Cabling products accept MINI-COM® Fiber Optic Adapter Modules for workspace environments.



9 MINI-COM® Outlet and PAN-WAY® Surface Raceway Solutions

Maintain fiber integrity – MINI-COM® Outlet and PAN-WAY® Surface Raceway products properly manage, spool, and maintain bend radius control in FTTD solutions.

Flexible environments – MINI-COM® Outlet and PAN-WAY® Surface Raceway products provide a broad range of work area solutions that provide modularity and scalability.

Cost effective configurations – MINI-COM® Outlet and PAN-WAY® Raceway products accept MINI-COM® Fiber Optic Adapter Modules for easy installation and upgrades.



10 PANDUIT Labeling and Administration Solutions

Lower cost of ownership – PANDUIT Labeling and Administration products identify network properly to allow faster, more efficient moves, adds and changes, troubleshooting and repairs.

Complete labeling solution – PANDUIT Labeling and Administration products provide the complete labeling solution to properly identify fiber cable, patch cords, connectors, modules, enclosures, work area outlets, surface raceway, patch panels and much more.

Flexibility and scalability – PANDUIT Labeling and Administration products create custom labels quickly and economically using PANDUIT labeling software, computer printable labels and wide range of printers (hand-held/portable and desktop).





PANDUIT Corp.
Tinley Park, Illinois 60477-3091

For more information
Visit us at www.panduit.com
Contact Customer Service by email: cs@panduit.com
or by phone: 800-777-3300



PANDUIT Europe Ltd.
London, UK
cs-emea@panduit.com
Phone: 44.20.8601.7200



PANDUIT Japan
Tokyo, Japan
cs-japan@panduit.com
Phone: 81.3.3767.7011



PANDUIT Singapore Pte. Ltd.
Republic of Singapore
cs-ap@panduit.com
Phone: 65.6379.6700



PANDUIT Latin America
Jalisco, Mexico
cs-la@panduit.com
Phone: 52.333.666.2501



PANDUIT Australia Pty. Ltd.
Victoria, Australia
cs-aus@panduit.com
Phone: 61.3.9794.9020



PANDUIT Canada
Markham, Ontario
cs-cdn@panduit.com
Phone: 800.777.3300

WORLDWIDE HEADQUARTERS

For a copy of *PANDUIT* product warranties, log on to www.panduit.com/warranty

© 2006 *PANDUIT* Corp.
ALL RIGHTS RESERVED
Printed in the U.S.A.
Brochure Number **SA-FBCB12**
4/2006