

# WIREMOLD



## UNIDUCT® 2700/2800/2900

### Surface Nonmetallic Latching Raceway System

#### INSTALLATION INSTRUCTIONS

Installation Instruction No.: 40307R2 – Updated July 2005

Wiremold Electrical Systems conform to and should be installed and properly grounded in compliance with requirements of the current National Electrical Code, Canadian Electrical Code, or codes administered by local authorities.

All electrical products may represent possible shock or fire hazard if improperly installed or used. Wiremold electrical products are UL listed, made for interior use only, and should be installed in conformance with current local and/or the National Electrical Code.

**CAUTION: For Low Voltage (50V or Less).**

#### DATA COMMUNICATION WIRING

The following procedure is recommended.

1. Chalk a path that raceway will follow.
2. Mark points where boxes will be installed.
3. Determine length of run from each box or corner. (*Measure runs from side to side of boxes.*)
4. Start from the feed point.
5. Peel release paper from adhesive strip and mount Uniduct raceway immediately to surface. (*Adhesive-backed Uniduct raceway should be mounted to clean, dry, grease-free, smooth surface.*) Apply pressure along entire raceway to ensure proper adhesion. For irregular or uneven surfaces, mechanical mounting may be necessary for best results.
6. Commence wiring. As you go along the length, push the wire into the open end of the Uniduct raceway and snap it closed. Use appropriate fittings wherever needed. (*See illustrations.*)
7. Uniduct raceway can be painted with acrylic latex paints to match the surrounding surface. Follow the application recommendations of each individual paint manufacturer.

##### External Elbow: 2718/2818/2918

**To go around external corner:** Install the Uniduct (2700/2800/-2900) butted as shown. Snap external elbow (2718/2818/2918) onto the Uniduct leaving no gap.

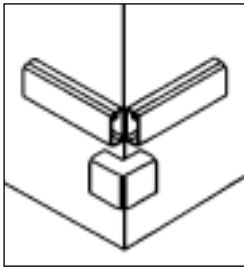

##### Internal Elbow: 2717/2817/2917

**To go around internal corner:** Install the Uniduct (2700/2800/2900) butted as shown. Snap internal elbow (2717/2817/2917) onto the Uniduct leaving no gap.

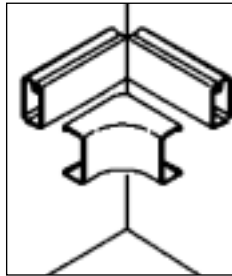

##### 90° Flat Elbow: 2711/2811/2911

**To make right angle turn on same surface:** Install the Uniduct (2700/2800/2900) butted as shown. Snap 90° flat elbow (2711/2811/2911) onto the Uniduct leaving no gap.

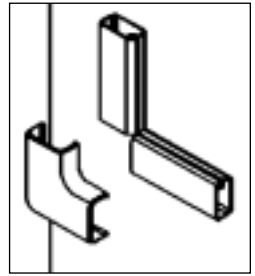

##### Fiber Optic External Elbow: 2818FO/2918FO

**To go around external corner and maintain 1 1/4" bend radius:** Mount the fitting base to the wall by using screws or the adhesive strip supplied. Butt the Uniduct as shown and snap the fitting cover over the base after the cabling is completed.

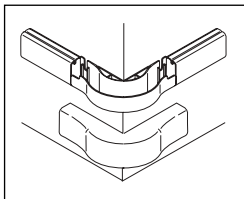

##### Fiber Optic Internal Elbow: 2817FO/2917FO

**To go around internal corner and maintain 1 1/4" bend radius:** Mount the fitting base to the wall by using screws or the adhesive strip supplied. Butt the Uniduct as shown and snap the fitting cover over the base after the cabling is completed.

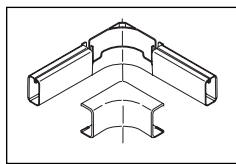

##### Fiber Optic 90° Flat Elbow: 2811FO/2911FO

**To make right angle turn on same surface and maintain 1 1/4" bend radius:** Mount the fitting base to the wall by using screws or the adhesive strip supplied. Butt the Uniduct as shown and snap the fitting cover over the base after the cabling is completed.

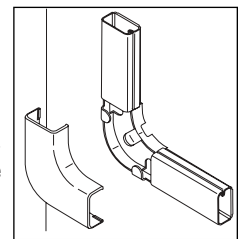

##### Tee: 2715/2815/2915

**For branching at right angles:** Install the Uniduct (2700/2800/-2900) butted as shown. Snap tee (2715/2815/-2915) onto the Uniduct leaving no gap.

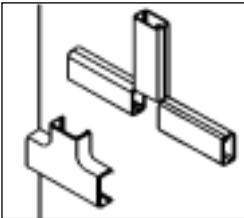

##### Fiber Optic Tee: 2815FO/2915FO

**For branching right angles and maintaining 1 1/4" bend radius:** Mount the fitting base to the wall by using screws or the adhesive strip supplied. Butt the Uniduct as shown and snap the fitting cover over the base after the cabling is completed.

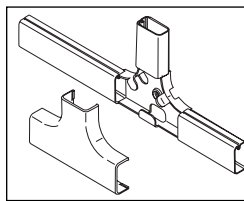

##### Cover Clip: 2706/2806/2906

**To join two pieces of Uniduct in line:** Install the Uniduct (2700/2800/-2900) butted as shown. Snap cover clip (2706/-2806/2906) onto the Uniduct leaving no gap.

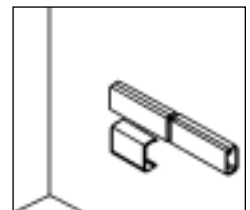

#### **WARNING! For best results install by date indicated on carton label.**

No warranty, expressed or implied, is made by The Wiremold Company with respect to adhesive bond performance. The conditions under which the raceway may be mounted and/or the surface upon which it may be applied are beyond the control of The Wiremold Company.

**Blank End Fitting:  
2710B/2810B/2910B**

**To cover the open end of the Uniduct:**  
Snap the blank end fitting (2710B/2810B/2910B) onto the open end of (2700/2800/2900) Uniduct.

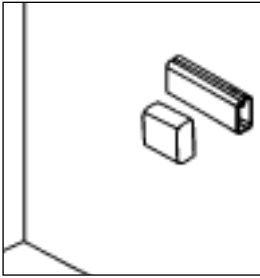

**Reducing Connector:  
2889/2989/2989A**

**To go from larger to smaller Uniduct:**  
Install the Uniduct (2700/2800/2900) butted as shown. Snap the reducing connector (2889/2989/2989A) onto the Uniduct leaving no gap. Snap cover clip (2706/2806/2906) over connection. When reducing from a fitting to raceway, cover clip is not required.

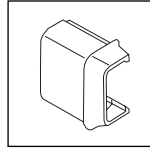

**Drop Ceiling Connector:  
2786/2886/2986**

**For bringing cables from ceiling to raceway:**  
Cut a hole in the ceiling tile right next to the metal grid. Drop the cables from the ceiling into the Uniduct. Push the drop ceiling connector (2786/2886/2986) through the hole so that the notch in the large end of the connector butts with the metal grid. Snap the drop ceiling connector (2786/2886/2986) onto the Uniduct (2700/2800/2900).

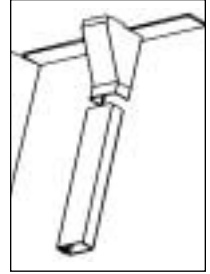

**TYPICAL PROCEDURE FOR INSTALLING  
DEVICE BOXES**

1. Remove proper tongue on the device box (NM2048) base. (See Figure 1.)
2. Notch proper knockout in cover using knife. (See Figure 2.) Use pliers to remove knockout inward for cleaner edge. (Trimming may be necessary.)
3. Fasten device box base to wall using screws (not provided).
4. Snap device box cover onto the base.
5. Mount device box and faceplate.

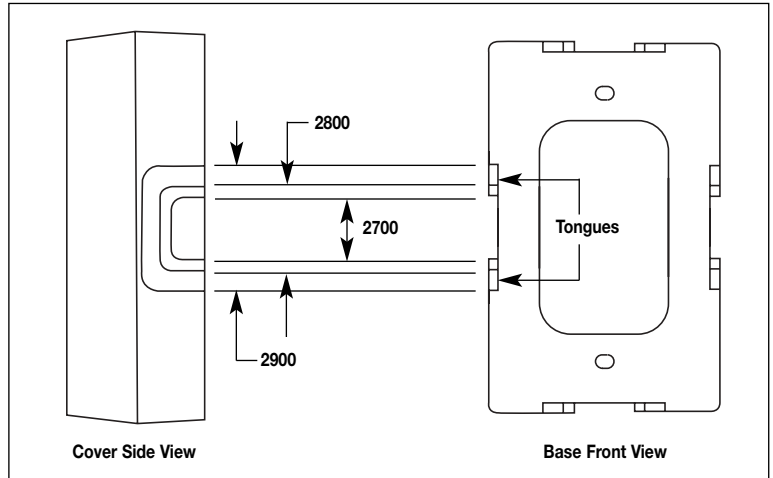

Figure 1

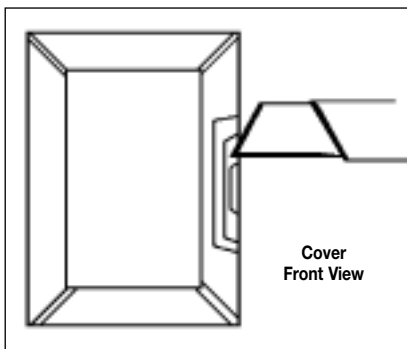

Figure 2

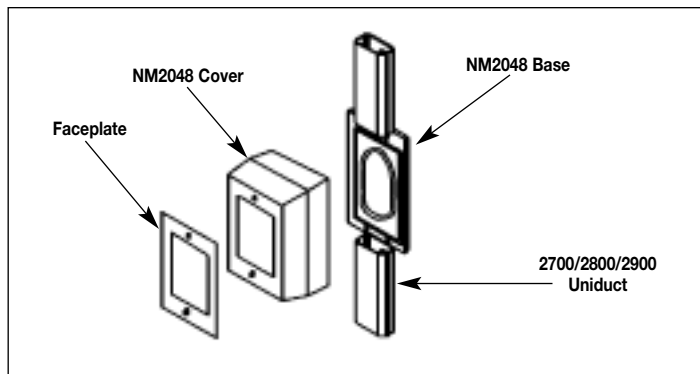

Figure 3

**WIREMOLD**



**Wiremold / Legrand**

U.S. and International:

60 Woodlawn Street • West Hartford, CT 06110

1-800-621-0049 • FAX 860-232-2062 • Outside U.S. 860-233-6251

Canada:

570 Applewood Crescent • Vaughan, Ontario L4K 4B4

1-800-723-5175 • FAX 905-738-9721

