

RIGID PVC CONDUIT & FITTINGS



Scepter[®]
Rigid PVC Conduit & Fittings



ELECTRICAL SYSTEMS

RIGID PVC CONDUIT & FITTINGS

- 12mm – 200mm
- 1/2" – 8"

IPEX
by aliaxis

We build tough products for tough environments[®]

TABLE OF CONTENTS

SCEPTER ELECTRICAL PRODUCTS.....	4
Applications.....	5
Advantages.....	6
Installation.....	8
Expansion & Contraction.....	11
Standards & Sample Specifications.....	15
SCEPTER PRODUCT CATALOGUE	
Conduit.....	16
Elbows.....	17
Pipe straps.....	18
Clamps & wall spacers.....	19
Couplings.....	19
Adapters.....	20
Bushings.....	21
End caps.....	21
End bells.....	22
O-ring expansion joints.....	22
Expansion & deflection fitting assemblies.....	22
One piece expansion joints.....	23
Strain relief connectors.....	23
Conduit cements & primer.....	24
Interlocking spacers.....	25
Access fittings.....	26
Pull elbows.....	28
Service entrance fittings.....	28
Meter offsets.....	28
Meter hubs.....	28
Expansion joints.....	29
Slip meter risers.....	29
F-Series gang boxes.....	30
Octagonal boxes.....	30
F-Series gang plates.....	31
F-Series gang weatherproof covers.....	32
Boxes.....	33
Junction box adapters.....	35
SCEPTER JBOXES.....	36
EPR KITS FOR CONDUIT REPAIR.....	44

SCEPTER CONDUIT & FITTINGS

SCEPTER Conduit & Fittings preferred for the LONG RUN

This manual provides the most comprehensive information about Scepter® PVC systems – from basic raw material to installation characteristics of the finished product. Written with the engineer, contractor and distributor in mind, it is based on laboratory test results and IPEX Electrical Inc.'s many years of field experience.

At IPEX, we have been extruding Scepter PVC conduit and molding Scepter PVC fittings since 1951. We formulate our own compounds, maintain strict quality control during production, and offer the most comprehensive line of electrical products throughout North America.

More important, our commitment to our customer extends beyond the sale. Quality control and thorough jobsite field reports have earned Scepter a reputation for product quality and service excellence.

Engineers, electricians, contractors, specifiers and utilities have realized for many years the advantages of PVC. Whether exposed, concealed in walls, encased in concrete, or directly buried, IPEX electrical products are preferred For The Long Run.



APPLICATIONS

- UTILITIES
- COMMUNICATIONS
- AIRPORTS
- CABLE
- SUBWAYS
- CAR WASHES
- PARKING GARAGES
- FISH PLANTS
- STEEL MILLS
- MARINAS
- BRIDGES AND TUNNELS
- MINES
- STREET AND HIGHWAY LIGHTING
- RESIDENTIAL APPLICATIONS
- WATER TREATMENT PLANTS
- SEWAGE TREATMENT PLANTS
- PULP AND PAPER INDUSTRIES
- AGRICULTURAL, DAIRY, HOGS, CATTLE, CHICKEN, ETC.
- FOOD PROCESSING PLANTS



SCEPTER CONDUIT & FITTINGS

ADVANTAGES

LABOUR SAVINGS

Compared to metal, PVC products reduce labor on a typical installation by up to two-thirds. The reason? PVC is easy to work with. It can also be cut and joined without the usual pipe vices, cutters, threading equipment, and reamers associated with metal conduit.

SUNLIGHT RESISTANT

The 2006 Canadian electrical code rule 2-130 is intended to ensure that totally enclosed nonmetallic raceways are properly protected against adverse effects from direct exposure to UV rays. electrical nonmetallic raceways marked for such application are suitable for installation and use for direct exposure to rays of the sun. Scepter Rigid PVC conduit meets the criteria for sunlight resistance, is approved for the purpose, and is appropriately marked.

LIGHTWEIGHT CONDUIT

Scepter Rigid PVC Conduit is one-half the weight of aluminum and one-sixth the weight of steel. As a result, handling and installation are easier and faster, reducing labor costs.

EASY JOINING

Solvent cementing is all that is required, eliminating the need for power-threading machines, pipe vices and cutting equipment. A hacksaw or carpenter's saw is the only equipment required.

STRENGTH

Scepter Rigid PVC Conduit offers both high impact and high tensile strength, even in cold temperatures. Scepter Rigid PVC Conduit and fittings meet and exceed all CSA and UL standards.

SCEPTER RIGID PVC CONDUIT SCHEDULE 40

Size		CSA Impact Test		UL Impact Test	
in	mm	@ -29°F	@ -34°C	@ 72°F	@ 23°C
1/2	12	8.9 ft.lbs	12 joules	50 ft.lbs	68 joules
3/4	20	8.9 ft.lbs	12 joules	80 ft.lbs	109 joules
1	25	8.9 ft.lbs	12 joules	100 ft.lbs	136 joules
1-1/4	32	8.9 ft.lbs	12 joules	120 ft.lbs	163 joules
1-1/2	40	8.9 ft.lbs	12 joules	150 ft.lbs	204 joules
2	50	8.9 ft.lbs	12 joules	190 ft.lbs	258 joules
2-1/2	65	8.9 ft.lbs	12 joules	210 ft.lbs	285 joules
3 - 6	75-150	8.9 ft.lbs	12 joules	220 ft.lbs	298 joules
8	75-150	8.9 ft.lbs	12 joules	n/a	n/a

Note:
CSA impacts are carried out at temperatures that are well below freezing, while UL impacts are tested at room temperature.

EASY WIRE PULLS

PVC's exceptionally smooth interior surface greatly reduces the amount of friction while pulling conductors/wires through long runs, even with 90° bends. A large pull-rope and wire-pulling lubricant should be used when pulling all conductors and wires.

NONCORRODING

PVC is immune to damage from naturally corrosive soil conditions, as well as electro-chemical and galvanic corrosion. This ensures lower maintenance costs and superior performance For The Long Run.

NONCONDUCTING

Scepter Rigid PVC Conduit pipe and fittings are nonsparking and nonconducting, thereby eliminating the most dangerous 'second point of contact' and 'phase to ground' faults. The use of a separate grounding conductor in a Scepter PVC conduit system gives a complete and positive ground for the whole system.

CHEMICAL RESISTANCE

One of the greatest benefits of PVC is its excellent chemical resistance. It resists attack by acids, alkalis, salt solutions, and many other types of chemicals. For more information on PVC and chemical resistance, refer to the IPEX Chemical Resistance Guide.

LONG LIFE

Scepter Rigid PVC Conduit pipe and fittings retain their original properties after years of exposure to heat and weather. In addition, resistance to fungi, bacterial action, rodents, termites and corrosive agents ensures a long, trouble-free life for PVC conduit installed indoors or outdoors.

FIRE RESISTANT

IPEX's proprietary PVC compound used to manufacture Scepter products is a self-extinguishing material and will not support combustion. Samples taken from an actual fire show the outer surface of the conduit was blistered and charred. The interior of the conduit, however, was unaffected. Additionally, the undamaged conductors were then removed and reinstalled in new conduit. Fire-resistant characteristics when tested to CAN ULC S102.2.

IPEX Compound	Flame Spread	Smoke Developed	Fuel Contribution
1/8" thickness	10 - 20	225 - 270	0
3/4" thickness	10 - 20	300 - 390	0

SCEPTER CONDUIT & FITTINGS

ADVANTAGES

FT-4 RATING

Scepter Rigid PVC conduit is certified to meet the requirements of FT-4 allowing its use in noncombustible construction per Section 3.1.5.20 of the National Building Code, which reads:

1.) Subject to the limits on the size of elements that penetrate fire separations as stated in Sentence 3.1.9.3.(2), within a fire compartment of a building required to be of noncombustible construction, totally enclosed nonmetallic raceways not more than 175mm in outside diameter, or of an equivalent rectangular area, are permitted to be used to enclose optical fibre cables and electrical wires and cables, provided the raceways exhibit a vertical char not more than 1.5m when tested in conformance with the Vertical Flame Test (FT - 4) Conduit or Tubing on Cable Tray in Clause 6.16 of CSA C22.2 No. 211.0, "General Requirements and Methods of Testing for Nonmetallic conduit."

CONCRETE TIGHT

Scepter Rigid PVC Conduit pipe and fittings are designed and engineered to be concrete tight in all weather conditions.

SUITABLE FOR DIRECT BURIAL

PVC is suitable for direct burial and requires no extra protection when installed in accordance with the Canadian Electrical Code, the National Electrical Code, and the local inspection authority guidelines. The usual care regarding trenches and backfilling should be respected.

ONE-SOURCE SPECIFICATION

IPEX offers a full range of PVC fittings and accessories. As a result, it is easy to specify a single source PVC system.

QUALITY CONTROL

In addition to IPEX's rigorous quality control testing, Scepter electrical products carry third-party certification by CSA, UL, and NRTL.

INSTALLATION

SUPPORT

Due to PVC's lightweight, support spacing is different than that used with metal conduits. Supporting straps should NOT be firmly tightened, so that linear movement of the pipe is possible. The maximum allowable support spacing, per the Canadian Electrical Code (CEC) is as follows:

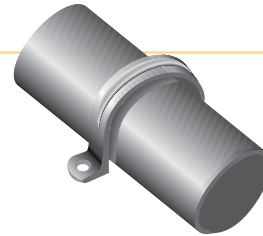

SUPPORT SPACING

Scepter Rigid PVC Conduit pipe and fittings are designed and engineered to be concrete tight in all weather conditions.

Nominal Conduit Diameter		Canadian Electrical Code Max. Support Spacing	
inches	mm	feet	metres
1/2	12	2-1/2	0.75
3/4	20	2-1/2	0.75
1	25	2-1/2	0.75
1-1/4	32	4	1.20
1-1/2	40	4	1.20
2	50	5	1.50
2-1/2	65	6	1.80
3	75	6	1.80
3-1/2	90	7	2.10
4	100	7	2.10
5	125	7	2.10
6	150	8	2.50
8	200	8	2.50



MAX OPERATING TEMPERATURE

The Canadian Electrical Code (CEC) allows the use of Scepter Rigid PVC Conduit up to a maximum ambient temperature of 167°F (75°C).

CUTTING

Scepter Rigid PVC Conduit can be easily cut on the jobsite by using a hacksaw, carpenter's saw or PVC conduit cutters. For larger sizes of conduit, the use of a mitre box is also recommended to ensure a square cut.

SCEPTER CONDUIT & FITTINGS

INSTALLATION

SOLVENT CEMENTING

After cutting Scepter Rigid PVC Conduit, remove all sharp edges or burrs from the inside of the conduit with a knife. Thoroughly clean the end of the pipe and inside the fitting with a rag or pipe cleaner. Check the pipe and fitting for a dry fit before cementing. Apply a generous amount of IPEX solvent cement to both surfaces; slide together and give a quarter turn to ensure the solvent is spread evenly on the material. Hold together for a few seconds until the joint is made.

Usually the solvent-cemented joint will be strong enough to install immediately. However, in climates with low temperatures or areas with high humidity, extra time may be required before moving the pipe for permanent installation. Solvent-cemented joints appear to "set up" instantly, but will take up to 24 hours to cure properly. After this time, the solvent-cemented joint has completely cured and is waterproof. For extreme cold weather installations, the use of IPEX PVC Primer is recommended. Normal installation temperatures are between 40°F (4°C) and 110°F (43°C), however, high strength joints have been made at temperatures as low as -15°F (-26°C) with quality cements. In these extreme conditions the cement must be kept warm to prevent excessive thickening and gelation in cold weather.

IPEX cements and primers are available in half-pint (250ml), pint (500ml), quart (1-litre) and gallon (4-litre) containers. The shelf life of conduit cement and primer is 2 years from the date of manufacture. The date code stamped on the bottom of the can is the date of manufacture, not the expiry date. Always verify that the cement is within this 2 year time frame before using.

BENDING

PVC is a thermoplastic material that, when heated, becomes soft and pliable. As a result, its shape can be altered.

A flameless heat source is recommended to heat the pipe. AN OPEN FLAME SHOULD NOT BE USED. An electric unit or an infra-red propane unit is recommended for heating the pipe.

The necessary temperature for bending Scepter Rigid PVC pipe is 260°F (127°C). The pipe must be heated evenly over an area approximately ten times the diameter of the pipe before any attempt at bending is made. Bending the pipe when it has not been thoroughly heated will cause the pipe to "kink." With proper care and a little practice, the bend will form easily.

Cooling the pipe with cold air or water will cause "spring back." Allow a few extra degrees of overbending to compensate for this phenomenon. The maximum bending radius shall be six times the internal diameter according to the Canadian Electrical Code and the National Electrical Code.

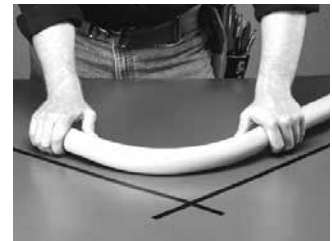

EXPANSION AND CONTRACTION

USING EXPANSION JOINTS

It is equally important to know when to install an expansion joint as it is to know how to correctly install the expansion joint. Expansion joints are required when the temperature change is greater than 25°F (14°C). Scepter Rigid PVC Conduit has a coefficient of linear expansion of 3.6×10^{-4} in./ft./°F (.054mm/m/°C). Generally, a 100 ft. (30.48m) run of PVC conduit will undergo a change in length of 3.6 inches (91.44mm) for every 100°F (56°C) temperature change.

For conduit installed indoors, the range of expansion and contraction can be calculated using the maximum air temperature plus the heat contributed by the conductors inside the conduit and the minimum air temperature expected. Expansion joints are not required indoors unless there are widely varying temperatures such as the attic of a building.

Conduit installed outdoors, exposed to direct sunlight, will be considerably hotter than the air temperature. As a guideline in this case, add 27°F (15°C) to the temperature change. Expansion joints should be installed to allow for all anticipated temperature changes.

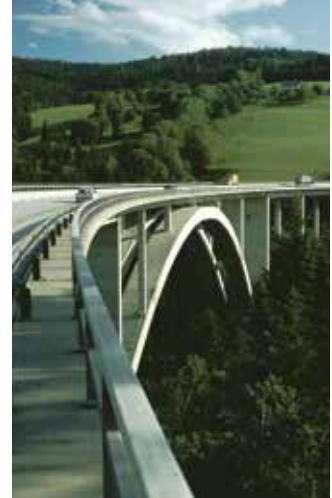

EXPANSION FORMULA

By using the following formulas and the charts below, the total expected expansion in a run can be easily determined:or

$$^{\circ}\text{F Total Expansion (in.)} = \text{length of run (ft.)} \times \text{temperature change (}^{\circ}\text{F)} \times 0.00036$$

$$^{\circ}\text{C Total Expansion (mm)} = \text{length of run (m)} \times \text{temperature change (}^{\circ}\text{C)} \times 0.054$$

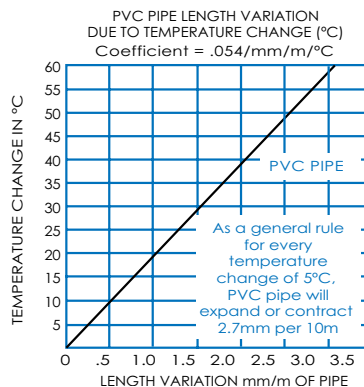
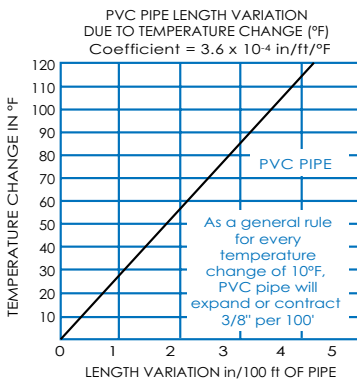

SCEPTER CONDUIT & FITTINGS

EXPANSION AND CONTRACTION

NUMBER OF EXPANSION JOINTS REQUIRED

Use the following equation to determine the number of expansion joints needed for a Scepter Rigid PVC Conduit installation:

$$\text{Number of joints} = \frac{\text{total expansion (mm or in)}}{E}$$

E = Expansion joint travel length 101.6mm (4") or 203.2mm (8") depending on diameter.

Always round up to the next whole number.

SETTING THE PISTON OPENING

The expansion joint must be installed to allow for expansion and contraction of the conduit run. On a cold day, if an expansion joint is installed completely closed with the piston bottomed, there is no room for expansion when the conduit is warmed. If it is installed open to the maximum on a hot day, the expansion joint will pull apart when cooled.

The correct piston opening for any installation condition can be easily determined using the formula below.

$$\text{Piston setting} = \text{compressed length} + \frac{\text{max. temperature} - \text{installation temperature}}{\text{max. temperature} - \text{min. temperature}} \times E$$

Formula can be used for both metric and imperial measurements.

Size (mm)	Size (in)	Compressed Length (mm)	Compressed Length (in)	Travel (mm)	Travel (in)
13	1/2	203.2	8.00	101.6	4
20	3/4	203.2	8.00	101.6	4
25	1	215.9	8.50	101.6	4
32	1-1/4	228.6	9.00	101.6	4
38	1-1/2	228.6	9.00	101.6	4
51	2	235.0	9.25	101.6	4
64	2-1/2	235.0	9.25	101.6	4
76	3	362.0	14.25	203.2	8
89	3-1/2	362.0	14.25	203.2	8
102	4	362.0	14.25	203.2	8
127	5	362.0	14.25	203.2	8
152	6	362.0	14.25	203.2	8

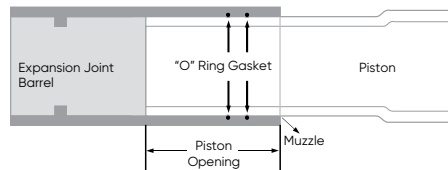

INSTALLATION OF EXPANSION JOINTS

USING EXPANSION JOINTS



Proper functioning of an expansion joint depends on three procedures:

1. The correct placement of the expansion joint.
2. The proper installation of Scepter Rigid PVC Conduit and the expansion joint.
3. The proper placement and fastening of support straps.

Legend

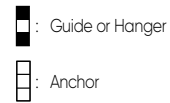

ONE EXPANSION JOINT - FIGURE 1

If only one expansion joint is needed between two boxes, the barrel of the joint should be rigidly fastened close to the first box. Scepter Rigid PVC Conduit should then be loosely supported with straps, allowing the conduit to move freely as it expands and contracts.

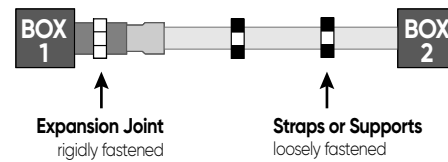

TWO EXPANSION JOINTS - FIGURE 2

If two expansion joints are needed, the joints should be firmly fastened back to back at the centre of the run. Scepter Rigid PVC Conduit should be loosely supported with straps, allowing the conduit to move freely as it expands and contracts.

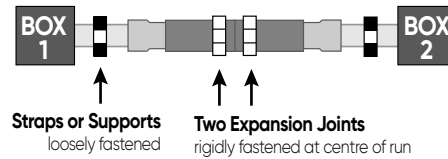

TWO EXPANSION JOINTS (ALTERNATIVE) - FIGURE 3

Alternatively, the centre of the run and the two expansion joints (located at the boxes) should be rigidly fastened. All other support straps should be loosely fastened.

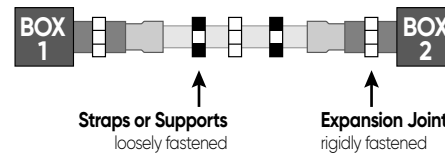

THREE OR MORE EXPANSION JOINTS - FIGURE 4

If more than two joints are needed in a very long run, they should be put in a series, one after the other. Each barrel must be rigidly fastened while conduit is loosely supported with straps allowing the conduit to move freely as it expands and contracts.

When installed in a series, each section acts independently of the other. Spacing of conduit supports must be in accordance with Section 12-1114 of the Canadian Electrical Code or NEC Article 347-8. (See Table on Support Spacing)

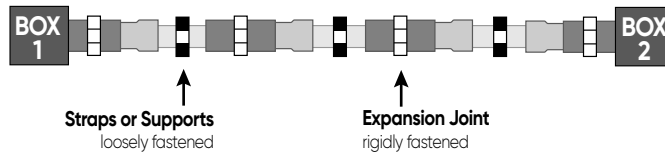

SCEPTER CONDUIT & FITTINGS

INSTALLATION OF EXPANSION JOINTS

INSTALLATION RECOMMENDATIONS

- Expansion joints should be mounted so the piston can travel in a straight line in the barrel. If the alignment is not straight, the piston will bind, preventing the joint from functioning correctly.
- The expansion joint barrel should be clamped tight, but the conduit mounted loose enough in its hangers to allow for movement as it expands and contracts.
- Scepter nonmetallic straps are correctly sized and designed for proper support, and must be used to secure the conduit.
- When expansion joints are used in a vertical position, the piston should be mounted in a downward position so dirt cannot deposit between the barrel and piston at the muzzle of the expansion joints.

COMMON MISTAKES

Three common mistakes are:

1. Forgetting to use expansion joints.
2. Not using enough expansion joints.
3. Overtightening of support straps.

It is more cost effective to use more expansion joints than needed, rather than too few. It is difficult to correct the problem after conductors are installed and in service. Failure to accommodate expansion/contraction may result in pipe fracture.



STANDARDS AND SAMPLE SPECIFICATIONS

LISTINGS

Scepter Rigid PVC Conduit is certified to the following:

CSA C22.2 No. 211.2

CSA C22.2 No. 211.0

UL Listed-UL651

Sunlight Resistant

Rated for use with 90°C conductors

NEMA TC2

Corps. of Engineers Spec. CE 303:01

Military Spec, Federal Spec. WC 1094A

Scepter Rigid PVC boxes and fittings are certified to the following:

C-22.2 No. 85

UL Listed

UL514B - UL514C



APPROVALS

Canadian Electrical Code, Part 1. Rules 12-1100 – 12-1122

SAMPLE SPECIFICATIONS

All wiring shall be installed in Rigid PVC conduit and secured to PVC boxes and cabinets by means of proper fittings. All boxes, access fittings and covers shall be furnished with threaded brass inserts, brass screws and PVC gaskets.

Rigid PVC fittings and junction boxes shall be used for all outlets, pull boxes and junction points. All PVC junction boxes shall be NEMA 1, 2, 3, 4, 4X, 6P, 12 and 13 rated and UL Listed for wet locations.

Exposed conduit shall be securely held in place by suitable hangers or straps with the maximum spacing of points for supports not exceeding those specified in the CEC or NEC. Except when embedded in concrete, rigid conduit pipe shall not be clamped tightly. It shall be supported in such a manner as to permit adequate linear movement, allowing for expansion and contraction of conduit due to temperature change. Where a temperature change exceeding 25°F (14°C) is anticipated, rigid PVC expansion joints shall be installed in accordance with the manufacturer's recommendations.

Proper care shall be taken when field bending, to maintain the internal diameter and wall thickness of the conduit.

The contractor shall furnish and install Scepter Rigid PVC conduit pipe and fittings made by IPEX. Where the engineer's specifications indicate Scepter products or equivalent, the equivalent shall be CSA certified and accepted by the Canadian Electrical Code. Due to broad manufacturing tolerances, all pipe and fitting products shall be of the same manufacturer.

SCEPTER PRODUCTS

RIGID CONDUIT



Nominal Size		Product Code	O.D.		I.D.		Min. Wall		Weight		Standard	
inches	mm		inches	mm	inches	mm	inches	mm	lbs./100	kg/100m		
1/2	12	(10')	032105	0.840	21.3	0.622	15.8	0.109	2.8	15	22.6	6,000
		(20')	032106									12,000
3/4	20	(10')	032107	1.050	26.7	0.824	20.9	0.113	2.9	21	31.2	4,400
		(20')	032108									8,800
1	25	(10')	032110	1.315	33.4	1.049	26.6	0.133	3.4	31	46.2	3,600
		(20')	032111									7,200
1-1/4	32	(10')	032112	1.660	42.2	1.380	35.1	0.140	3.6	42	63.0	3,300
		(20')	032114									6,600
1-1/2	40	(10')	032115	1.900	48.3	1.610	40.9	0.145	3.7	53	78.4	2,250
		(20')	032116									4,500
2	50	(10')	032120	2.375	60.3	2.067	52.5	0.154	3.9	71	105.5	1,400
		(20')	032121									2,800
2-1/2	65	(10')	032125	2.875	73.0	2.469	62.7	0.203	5.2	112	167.2	780
		(20')	032126									1,560
3	75	(10')	032130	3.500	88.9	3.068	77.9	0.216	5.5	166	247.8	780
		(20')	032131									1,560
3-1/2	90	(10')	032135	4.000	101.6	3.548	90.1	0.226	5.7	200	297.7	630
		(20')	032136									1,260
4	100	(10')	032140	4.500	114.3	4.026	102.3	0.237	6.0	236	352.4	600
		(20')	032141									1,200
5	125	(10')	032150	5.563	141.3	5.047	128.2	0.258	6.6	321	478.5	230
		(20')	032151									460
6	150	(10')	032160	6.625	168.3	6.065	154.1	0.280	7.1	417	621.0	260
		(20')	032161									520
8	200	(10')	032180	8.620	219.0	7.980	202.6	0.322	8.18	559	833.1	140
		(20')	032181									280

WEIGHT COMPARISON OF RIGID PVC CONDUIT

Nominal Size		Rigid PVC		Aluminum		Rigid Steel	
inches	mm	inches	mm	inches	mm	inches	mm
1/2	12	15	23	28	41	79	118
3/4	20	21	31	27	54	105	157
1	25	31	46	53	79	153	228
1-1/4	32	42	63	70	104	201	300
1-1/2	40	53	78	86	129	249	371
2	50	71	106	116	173	334	498
2-1/2	65	112	167	183	272	527	786
3	75	166	248	239	356	690	1029
3-1/2	90	200	298	288	429	831	1239
4	100	236	352	340	507	982	1464
5	125	321	479	465	694	1334	1989
6	150	417	621	613	914	1771	2641

90° ELBOWS c/w Solvent Bell End

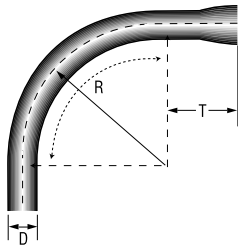

* plain end x plain end only

Size (inches)	Part Number	Product Code	D (in)	T (in)	R (in)
1/2	EE1090	069081	0.840	1.500	4.00
3/4	EE1590	069082	1.050	1.500	4.50
1	EE2090	069083	1.315	1.875	5.75
1-1/4	EE2590	069084	1.660	2.000	7.25
1-1/2	EE3090	069085	1.900	2.000	8.25
2	EE3590	069086	2.375	2.000	9.50
2-1/2	EE4090	069087	2.875	3.000	10.50
3	EE4590	069088	3.500	3.125	13.00
3-1/2*	EE5090	069089	4.000	3.250	15.00
4	EE5590	069090	4.500	3.375	16.00
5	EE6090	069091	5.563	3.625	24.00
6	EE6590	069092	6.625	3.750	30.00
8*	EE7090	069099	8.622	8.300	48.00

45° ELBOWS c/w Solvent Bell End

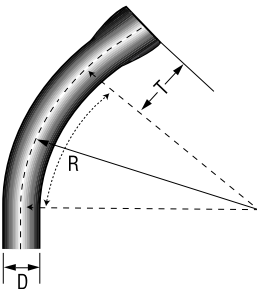

* plain end x plain end only

Size (inches)	Part Number	Product Code	D (in)	T (in)	R (in)
1/2	EE1045	069201	0.840	1.500	4.00
3/4	EE1545	069202	1.050	1.500	4.50
1	EE2045	069203	1.315	1.875	5.75
1-1/4	EE2545	069204	1.660	2.000	7.25
1-1/2	EE3045	069205	1.900	2.000	8.25
2	EE3545	069206	2.375	2.000	9.50
2-1/2	EE4045	069207	2.875	3.000	10.50
3	EE4545	069208	3.500	3.125	13.00
3-1/2*	EE5045	069209	4.000	3.250	15.00
4	EE5545	069210	4.500	3.375	16.00
5	EE6045	069211	5.563	3.625	24.00
6	EE6545	069212	6.625	3.750	30.00
8*	EE7045	069213	8.622	8.300	48.00

30° ELBOWS Plain End x Plain End

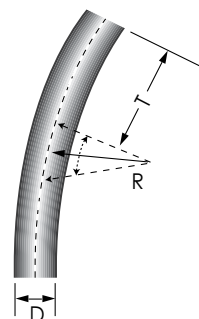

Size (inches)	Part Number	Product Code	D (in)	T (in)	R (in)
1/2	EE1030	069241	0.840	1.500	4.00
3/4	EE1530	069242	1.050	1.500	4.50
1	EE2030	069243	1.315	1.875	5.75
1-1/4	EE2530	069244	1.660	2.000	7.25
1-1/2	EE3030	069245	1.900	2.000	8.25
2	EE3530	069246	2.375	2.000	9.50
2-1/2	EE4030	069247	2.750	3.000	10.50
3	EE4530	069248	3.500	3.125	13.00
3-1/2	EE5030	069249	4.000	3.250	15.00
4	EE5530	069250	4.500	3.375	16.00
5	EE6030	069251	5.563	3.625	24.00
6	EE6530	069252	6.625	3.750	30.00
8	EE7030	069254	8.622	8.300	48.00

SCEPTER PRODUCTS

UTILITY 90° ELBOWS c/w Solvent Bell End

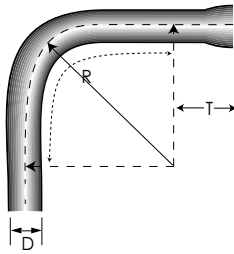

Size (inches)	Part Number	Product Code	D (in)	T (in)	R (in)
2	NSL 2-24	069257	2.375	41.200	24.00
2	NSL 2-36	069260	2.375	31.700	36.00
3	NSL 3-24	069265	3.500	41.200	24.00
3	NSL 3-36	069261	3.500	31.700	36.00
4	NSL 4-36	069267	4.500	31.700	36.00
4	NSL 4-48	069266	4.500	31.700	48.00
5	NSL 5-36	069263	5.563	31.700	36.00
6	NSL 6-36	069264	6.625	31.700	36.00

CSA Utility 90° Elbows are made from 10 ft. pipe.

PIPE STRAPS PVC 2 Hole



Size inches	Part Number	Product Code
1/2	PS10	077811
3/4	PS15	077812
1	PS20	077813
1-1/4	PS25	077814
1-1/2	PS30	077815
2	PS35	077816

PIPE STRAPS POLYETHYLENE (PE) 2 Hole



Size inches	Part Number	Product Code
2-1/2	PS40	077262
3	PS45	077263
4	PS55	077264

PIPE STRAPS COATED STEEL 2 Hole



Size inches	Part Number	Product Code
2	CS35	077818
2-1/2	CS40	077819
3	CS45	077820
3-1/2	CS50	077821
4	CS55	077822
5	CS60	077824
6	CS65	077823

PIPE STRAPS COATED STEEL 1 Hole



Size inches	Part Number	Product Code
1/2	CS10-1	077831
3/4	CS15-1	077832
1	CS20-1	077833
1-1/4	CS25-1	077834
1-1/2	CS30-1	077835
2	CS35-1	077836
2-1/2	CS40-1	077837
3	CS45-1	077838
3-1/2	CS50-1	077839
4	CS55-1	077840



NONMETALLIC CONDUIT CLAMPS & WALL SPACERS

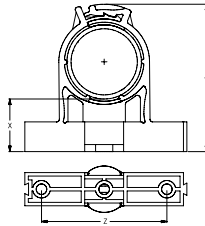

Size (inches)	Part Number	Product Code	X (in)	Y (in)	A (in)
1/2	CCS10	077794	1.191	2.414	1.824
3/4	CCS15	077796	1.195	2.660	2.106
1	CCS20	077797	1.215	2.962	2.443
1-1/4	CCS25	077798	1.182	3.300	2.855
1-1/2	CCS30	077799	1.193	3.600	3.170
2	CCS35	077800	1.195	4.135	3.785
Base	CCS-B	077343	-	-	-

Note: CCS-B are sold individually, two pieces are required to create one base unit.

COUPLINGS

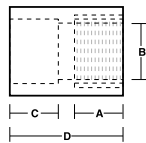

Size (inches)	Part Number	Product Code	A (in)	B (in)	C (in)
1/2	EC10	077001	1.080	0.840	1.437
3/4	EC15	077002	1.300	1.050	1.703
1	EC20	077003	1.590	1.315	2.031
1-1/4	EC25	077004	2.000	1.660	2.156
1-1/2	EC30	077005	2.230	1.900	2.281
2	EC35	077006	2.720	2.375	2.406
2-1/2	EC40	077007	3.320	2.875	3.187
3	EC45	077008	4.000	3.500	3.437
3-1/2	EC50	077009	4.500	4.000	3.625
4	EC55	077010	5.000	4.500	3.750
5	EC60	077011	6.120	5.563	4.187
6	EC65	077012	7.370	6.625	4.562

SCEPTER PRODUCTS

REPAIR COUPLING SLEEVES

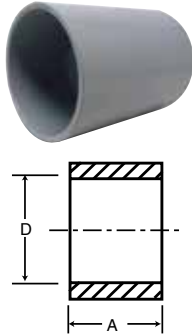

Size inches	Part Number	Product Code	A (in)	D Min (in)	D Max (in)
2	REC35	277293	2.405	2.367	2.399
3	REC45	277295	3.600	3.507	3.523
4	REC55	277296	3.920	4.506	4.524
5	REC60	277297	4.275	5.583	5.603
6	REC65	277298	4.620	6.647	6.669

5° COUPLINGS

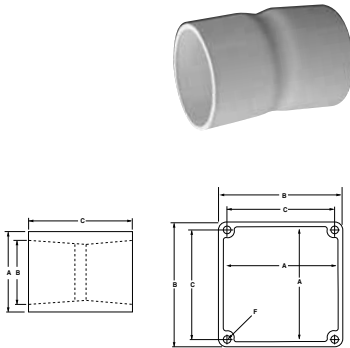

Size inches	Part Number	Product Code	L inches
2	5EC35	077100	4.0
2-1/2	5EC40	077101	5.5
3	5EC45	077103	6.0
3-1/2	5EC50	077102	7.0
4	5EC55	277092	7.0
5	5EC60	277093	7.5
6	5EC65	077106	11.0

TERMINAL ADAPTERS

1/2" - 1-1/4" Tapered Thread; 1-1/2" - 6" Non-Tapered Thread

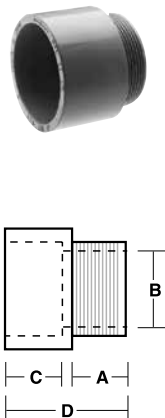

Size (inches)	Part Number	Product Code	A (in)	B (in)	C (in)	D (in)
1/2	TA10	077021	0.700	0.591	0.750	1.550
3/4	TA15	077022	0.675	0.790	1.000	1.750
1	TA20	077023	0.625	1.000	1.115	1.860
1-1/4	TA25	077024	0.640	1.311	1.300	2.125
1-1/2	TA30	077025	0.725	1.530	1.425	2.250
2	TA35	077026	0.800	1.970	1.150	2.100
2-1/2	TA40	077027	0.800	2.346	1.900	2.930
3	TA45	077028	0.815	2.915	2.000	3.055
3-1/2	TA50	077029	1.000	3.385	1.715	3.055
4	TA55	077030	0.815	3.850	1.990	3.215
5	TA60	077031	1.105	4.810	2.000	5.985
6	TA65	077032	1.105	5.825	2.130	6.500

FEMALE ADAPTERS

NPT Tapered Thread

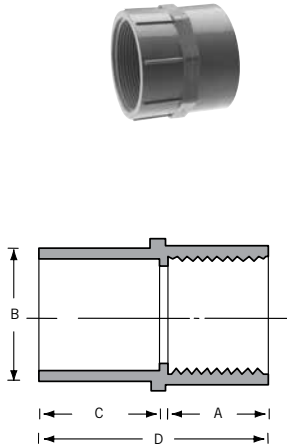

Size (inches)	Part Number	Product Code	A (in)	B (in)	C (in)	D (in)
1/2	FA10	077041	0.800	0.620	0.825	1.725
3/4	FA15	077042	0.800	0.820	1.000	1.900
1	FA20	077043	1.000	1.065	1.200	2.300
1-1/4	FA25	077044	1.015	1.395	1.300	2.425
1-1/2	FA30	077045	1.050	1.575	1.290	2.440
2	FA35	077046	1.075	2.050	1.375	2.550
2-1/2	FA40	077047	1.675	2.470	1.985	3.760
3	FA45	077048	1.630	3.090	2.150	4.100
3-1/2	FA50	077049	1.800	3.540	2.000	3.985
4	FA55	077050	1.755	4.025	2.185	4.210
5	FA60	077051	2.065	5.035	3.000	5.240
6	FA65	077052	2.065	6.045	3.000	5.235

REDUCER BUSHINGS



Size inches	Part Number	Product Code
3/4 x 1/2	1805	077300
1 x 1/2	1805-1	077301
1 x 3/4	1806	077302
1-1/4 x 3/4	1807-1	077303
1-1/4 x 1	1807	077304
1-1/2 x 1	1808-1	077305
1-1/2 x 1-1/4	1808	077306
2 x 1	1809-1	077313
2 x 1-1/4	1809	077307
2 x 1-1/2	1810	077308
2-1/2 x 2	1811	077309
3 x 2	1812-1	077310
3 x 2-1/2	1812	077311
4 x 2	1813-1	077319
4 x 3	1813	077312
4 x 3-1/2	1814	077317



THREADED REDUCER BUSHINGS

Size inches	Part Number	Product Code
3/4 x 1/2	1825	077314
1 x 1/2	1826	077315
1 x 3/4	1827	077316

SCEPTER PRODUCTS

END CAPS



Size inches	Part Number	Product Code
1/2	CAP10	077421
3/4	CAP15	077422
1	CAP20	077423
1-1/4	CAP25	077424
1-1/2	CAP30	077425
2	CAP35	077426
2-1/2	CAP40	077427
3	CAP45	077428
3-1/2	CAP50	277085
4	CAP55	077430
5	CAP60	077431
6	CAP65	077432
8	CAP80	077657

END BELLS



Size inches	Part Number	Product Code
1/2	EB10	077406
3/4	EB15	077085
1	EB20	077323
1-1/4	EB25	077324
1-1/2	EB30	077325
2	EB35	077326
2-1/2	EB40	077327
3	EB45	077328
3-1/2	EB50	077329
4	EB55	077330
5	EB60	077331
6	EB65	077332
8	EB80	277094

"O" RING EXPANSION JOINTS

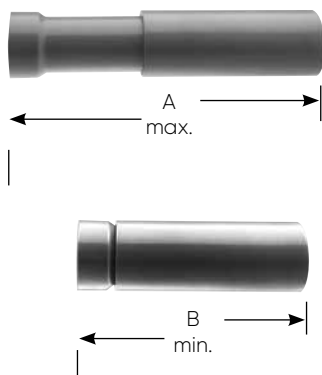

Size (inches)	Part Number	Product Code	A max. (in.)	B min. (in.)	Travel (in)
1/2	EJ10	277156	12.00	8.00	4
3/4	EJ15	077382	12.00	8.00	4
1	EJ20	077383	12.50	8.50	4
1-1/4	EJ25	077384	13.00	9.00	4
1-1/2	EJ30	077385	13.00	9.00	4
2	EJ35	077386	13.25	9.25	4
2-1/2	EJ40	077387	13.25	9.25	4
3	EJ45	077388	22.25	14.25	8
3-1/2	EJ50	077389	22.25	14.25	8
4	EJ55	077390	22.25	14.25	8
5	EJ60	077391	22.25	14.25	8
6	EJ65	077392	22.25	14.25	8

EXPANSION & DEFLECTION FITTING ASSEMBLIES



Size inches	Part Number	Description	Product Code
2	SE-J-35	Complete Assembly	077889
3	SE-J-45	Complete Assembly	077890
4	SE-J-55	Complete Assembly	077891

ONE PIECE EXPANSION JOINTS (OPEJ)



Size (inches)	Part Number	Product Code	A Dia.(in)	2 Length	3 Length	Overall Length
1/2	OPEJ10	077018	1.102	0.60	2.465	3.25
3/4	OPEJ15	077019	1.314	0.729	2.646	3.50
1	OPEJ20	077053	1.610	0.885	2.725	3.75
1-1/4	OPEJ25	077054	1.987	0.950	2.895	4.00
1-1/2	OPEJ30	077061	2.208	1.075	3.030	4.25
2	OPEJ35	077063	2.701	1.140	3.206	4.50

NONMETALLIC THREADED STRAIN RELIEF CONNECTORS

The Strain Relief Connectors come with everything needed to make a cable connection. The package includes a connector body, cap, and grommets that cover a wide range of cable types and sizes to provide added flexibility on the jobsite.

These specially designed grommets have collapsing teeth and an inverting membrane which secures cables and provides exceptional strain relief at termination points. The grommets are made from a specially formulated TPE material that provides exceptional grip and durability.

Size inches	Configuration	Part Number	Product Code	
			NEW	OLD

Nonmetallic Threaded Strain Relief Connectors c/w "O"Ring, Locknut & 6 Grommets

1/2	Threaded	TSRC10A	277081	077754
3/4	Threaded	TSRC15A	277079	077756
3/4	Solvent Cement	SRC15A	277080	077985



Strain Relief Connectors Grommet Dimensions



Round Small Grommet
0.335" to 0.395"



Round Medium Grommet
0.395" to 0.495"



Round Large Grommet
0.495" to 0.575"



Oval Large Grommet
0.451" to 0.225" to 0.585" x 0.282"

SCEPTER PRODUCTS

CONDUIT CEMENTS & PRIMERS

IPEX Electrical 100 Conduit Cements are low VOC. Our reduced emission cements have been tested to meet the requirements of SCAQMD Rule 1168, Test Method 316A (South Coast Air Quality Management District).

- Low VOC Solvent Cement is LEED (Leadership in Energy and Environmental Design) compliant
- PVC is recyclable and can be reground into new product
- VOC emissions are less than 510 grams per litre for PVC Solvent Cement



IPEX 100 PVC CONDUIT SOLVENT CEMENT c/w Applicator Cap

Size inches	Part Number	Product Code
125ml	S100PT25	074717
250ml	S100PT5	074713
500ml	S100PT	074714
1L	S100QT	074715
4L	S100GAL	074716



IPEX 100T PRIMER

Size inches	Part Number	Product Code
250ml	C100PT5	074306
500ml	C100PT	074307
1L	C100QT	074308

EMPTY APPLICAN

Size inches	Part Number	Product Code
500ml (Pint)	APPLICAN	074728

AVERAGE # OF JOINTS PER PINT OR QUART OF CEMENT

Nominal Pipe Size		# of Joints per Pint	# of Joints per Quart	Nominal Pipe Size		# of Joints per Pint	# of Joints per Quart
inches	mm			inches	mm		
1/2	12	350	700	2-1/2	12	40	80
3/4	19	200	400	3	19	35	70
1	25	150	300	3-1/2	25	30	60
1-1/4	32	110	220	4	32	24	48
1-1/2	38	80	160	5	38	10	20
2	50	45	90	6	50	8	16

INTERLOCKING SPACERS

IPEX's interlocking spacers provide uniform separation between the rows and columns of conduits and when assembled with conduit create a stable structure for the concrete. Spacers connect quickly and easily by sliding together horizontally and snapping together vertically and provide true customization for any configuration of duct bank. Superior features like the molded rebar slots for efficient drop-in installation of full length rebar and integral holes in base spacers for securing in place save time and effort.

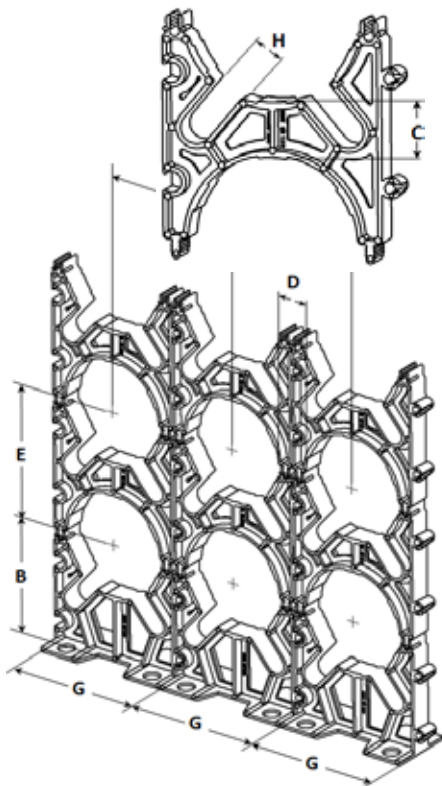

INTERMEDIATE VERTICAL-LOK SPACERS

Size (inches)	Part Number	Product Code	Dimensions (inches)					
			C	D	E	F	G	H
2 x 1-1/2	IS3530	029550	1.52	1.50	3.95	3.95	3.94	0.63
2 x 2	IS3535	029551	2.03	2.06	4.48	4.48	4.47	0.63
2 x 3	IS3545	029552	3.00	3.03	5.45	5.45	5.44	0.63
3 x 1-1/2	IS4530	029582	1.50	1.45	5.15	5.12	5.12	0.88
3 x 2	IS4535	029554	2.00	1.88	5.64	5.63	5.63	0.88
3 x 3	IS4545	029555	3.00	2.88	6.66	6.63	6.63	0.88
4 x 1	IS5520	029583	1.00	1.03	5.66	5.63	5.63	0.88
4 x 1-1/2	IS5530	029557	1.50	1.39	6.13	6.14	6.13	0.88
4 x 2	IS5535	029558	2.00	1.88	6.64	6.63	6.63	0.88
4 x 3	IS5545	029559	3.00	2.90	7.64	7.64	7.63	0.88
5 x 1-1/2	IS6030	029584	1.68	1.69	7.37	7.37	7.37	0.88
5 x 2	IS6035	029561	2.25	2.15	7.89	7.89	7.88	0.88
5 x 3	IS6045	029562	3.06	2.96	8.70	8.70	8.69	0.88
6 x 1-1/2	IS6530	029563	1.50	1.38	8.24	8.22	8.21	0.88
6 x 2	IS6535	029564	2.00	1.89	8.74	8.73	8.72	0.88
6 x 3	IS6545	029565	3.00	2.90	9.77	9.77	9.75	0.88
8 x 2	IS8035	029294	2.06	2.00	10.58	10.80	10.80	*

* Do not have rebar slots or base holes

BASE VERTICAL-LOK SPACERS

Size (inches)	Part Number	Product Code	Dimensions (inches)		
			A	B	H
2 x 1-1/2	BS3530	029566	3.04	4.25	0.63
2 x 2	BS3535	029567	3.04	4.25	0.63
2 x 3	BS3545	029568	3.04	4.25	0.63
3 x 1-1/2	BS4530	029585	3.00	5.84	0.88
3 x 2	BS4535	029570	2.97	4.78	0.88
3 x 3	BS4545	029571	3.00	4.81	0.88
4 x 1	BS5520	029586	3.00	5.32	0.88
4 x 1-1/2	BS5530	029573	3.00	5.31	0.88
4 x 2	BS5535	029574	3.06	5.38	0.88
4 x 3	BS5545	029575	3.06	5.38	0.88
5 x 1-1/2	BS6030	029587	3.00	5.84	0.88
5 x 2	BS6035	029577	3.13	5.94	0.88
5 x 3	BS6045	029578	3.19	6.00	0.88
6 x 1-1/2	BS6530	029579	3.02	6.38	0.88
6 x 2	BS6535	029580	3.02	6.38	0.88
6 x 3	BS6545	029581	3.00	6.38	0.88
8 x 2	BS8035	029293	3.00	7.25	*

* Do not have rebar slots or base holes

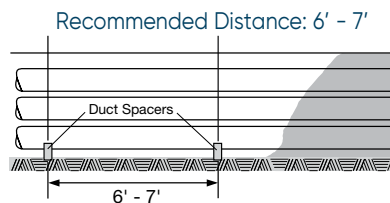
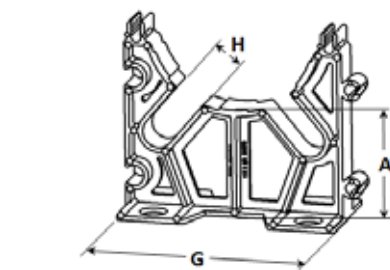

SCEPTER PRODUCTS

ACCESS FITTINGS

No other manufacturer offers such an extensive range of access fitting sizes (1/2" to 4") or hub configurations (LL, T, TB, LB, E, C, LR). CSA certified and UL listed, Scepter access fittings come fully factory assembled so parts cannot be misplaced during shipping and handling.

Manufactured with threaded brass screws and inserts, and flexible PVC gaskets, Scepter access covers can be removed as often as needed without wear or cracking. Stainless steel screws are available on request.



ACCESS FITTINGS DIMENSIONS

Size inches	A	B	C	D	E	F	G	H	I	J	K	L
	inches											
1/2	5.6	0.6	1.3	1.1	0.8	4.3	4.1	1.3	2.5	2.3	1.0	0.8
3/4	5.6	0.8	1.5	1.3	1.1	5.4	4.1	1.3	2.5	2.8	1.0	0.8
1	6.5	0.9	1.7	1.6	1.3	6.3	4.8	1.5	2.1	3.3	1.1	1.1
1-1/4	7.9	1.1	2.3	2.0	1.7	7.6	5.8	1.8	3.6	4.0	1.6	1.0
1-1/2	8.5	1.1	2.7	2.3	1.9	8.3	6.5	1.8	3.9	4.3	1.7	1.1
2	10.9	1.2	3.2	2.8	2.4	10.5	8.2	2.3	4.5	5.4	2.0	1.2
2-1/2	14.6	1.8	4.5	4.0	2.9	13.6	9.8	3.8	6.2	7.3	2.6	-
3	14.6	1.9	4.5	4.0	3.5	13.6	10.9	2.7	6.2	7.3	2.6	-
3-1/2	17.0	2.1	5.5	5.0	4.0	16.0	11.5	4.5	7.5	8.5	3.0	-
4	17.0	2.1	5.5	5.0	4.5	16.0	11.5	4.5	7.5	8.5	3.0	-

Hub Size (in)	Part Number	Product Code
---------------	-------------	--------------

ACCESS FITTINGS TYPE LL

1/2	SLL10S	077521
3/4	SLL20S	077522
1	SLL30S	077523
1-1/4	SLL40S	077524
1-1/2	SLL50S	077525
2	SLL60S	077526
2-1/2	SLL70S	077527
3	SLL80S	077528
3-1/2	SLL90S	077530
4	SLL100S	077529

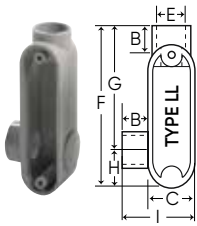

ACCESS FITTINGS TYPE T

1/2	ST10S	077461
3/4	ST20S	077462
1	ST30S	077463
1-1/4	ST40S	077464
1-1/2	ST50S	077465
2	ST60S	077466
2-1/2	ST70S	077467
3	ST80S	077468
3-1/2	ST90S	077571
4	ST100S	077572

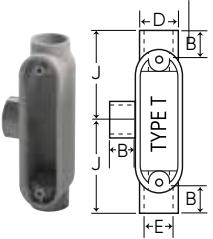

ACCESS FITTINGS TYPE TB

1/2	STB10S	077451
3/4	STB20S	077452
1	STB30S	077453
1-1/4	STB40S	077454
1-1/2	STB50S	077455
2	STB60S	077456

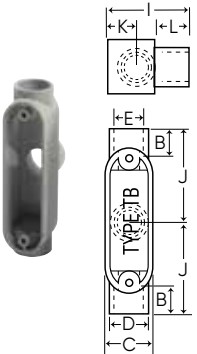

ACCESS FITTINGS TYPE LB

1/2	SLB10S	077541
3/4	SLB20S	077542
1	SLB30S	077543
1-1/4	SLB40S	077544
1-1/2	SLB50S	077545
2	SLB60S	077546
2-1/2	SLB70S	077547
3	SLB80S	077548
3-1/2	SLB90S	077549
4	SLB100S	077550



Hub Size (in)	Part Number	Product Code
---------------	-------------	--------------

ACCESS FITTINGS TYPE E

1/2	SE10S	077561
3/4	SE20S	077562
1	SE30S	077563
1-1/4	SE40S	077564
1-1/2	SE50S	077565
2	SE60S	077566
2-1/2	SE70S	077567

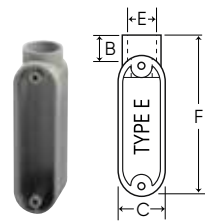

ACCESS FITTINGS TYPE C

1/2	SC10S	077501
3/4	SC20S	077502
1	SC30S	077503
1-1/4	SC40S	077504
1-1/2	SC50S	077505
2	SC60S	077506
2-1/2	SC70S	077507
3	SC80S	077508
3-1/2	SC90S	077510
4	SC100S	077509

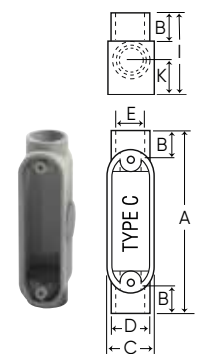

ACCESS FITTINGS TYPE LR

1/2	SLR10S	077481
3/4	SLR20S	077482
1	SLR30S	077483
1-1/4	SLR40S	077484
1-1/2	SLR50S	077485
2	SLR60S	077486
2-1/2	SLR70S	077480
3	SLR80S	077488
3-1/2	SLR90S	077487
4	SLR100S	077489

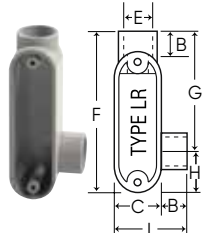

All access fittings are CSA certified and UL listed for wet locations.

Access Fittings are supplied with threaded brass inserts, combination brass head screws, PVC gasket and cover.

Stainless steel screws are available upon request.

SCEPTER PRODUCTS



"TWO IN ONE" PULL ELBOW

The "two in one" access pull elbow reduces inventory costs (3/4" hub fitting supplied with 3/4" x 1/2" reducers). This pull elbow is approved for wet locations and provides for easy wire pulling.

Size inches	Part Number	Product Code
1/2 or 3/4	PE15/10	077491

SERVICE ENTRANCE FITTINGS



Size inches	Part Number	Product Code
1/2	EF10	077281
3/4	EF15	077282
1	EF20	077283
1-1/4	EF25	077284
1-1/2	EF30	077285
2	EF35	077286
2-1/2	EF40	077287
3	EF45	077288
3-1/2	EF50	077289
4	EF55	077290

LONG METER OFFSETS Fabricated

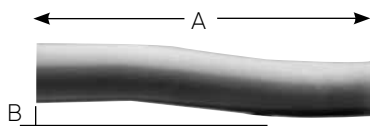

Size inches	Part Number	Product Code	A inches	B inches
1-1/4	LMO25	069641	12	0.92
1-1/2	LMO30	069645	12	1.69
2	LMO35	069646	14	1.52

METER OFFSETS



Size inches	Part Number	Product Code
1-1/4	MO25	077941
2	MO35	077942
2-1/2	MO40	277084

METER HUBS



Size inches	Part Number	Product Code
1-1/4	MHU25	077961
1-1/2	MHU30	077963
2	MHU35	077965
2-1/2	MHU40	077967
3	MHU45	077968

These special Scepter PVC expansion joints are supplied with the appropriately sized TA fitting. Assembled at the factory, the fittings are ready for installation directly to the meter socket. The installer needs only to 'set' the piston opening when connecting the underground raceway.



SCEPTER PVC EXPANSION JOINTS (c/w TA fitting)

Size inches	Part Number	Product Code
2	EJ35TA	077680
2-1/2	EJ40TA	077398
3	EJ45TA	077681
4	EJ55TA	077682

SCEPTER SLIP METER RISERS (c/w TA fitting)

Size inches	Part Number	Product Code
2	SMR20TA	068063
2-1/2	SMR25TA	068064
3	SMR30TA	068373
4	SMR40TA	068065

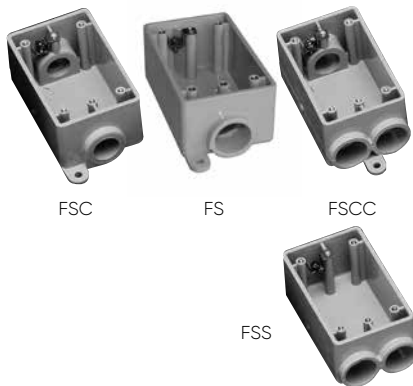

Outside Dimensions:
Length, 4-9/16" - Width, 2-13/16" - Depth, 2"

Hub Size (inches)	Part Number	Product Code	Volume (in ³)
1/2	FSC10	077607	17.0
3/4	FSC15	077608	17.0
1/2	FS10	077601	17.5
3/4	FS15	077602	17.5
1/2	FSCC10	077622	16.3
3/4	FSCC15	077623	16.3
1/2	FSS10	077604	17.0
3/4	FSS15	077605	17.0

Note: 10 = 1/2" Hub, 15 = 3/4" Hub

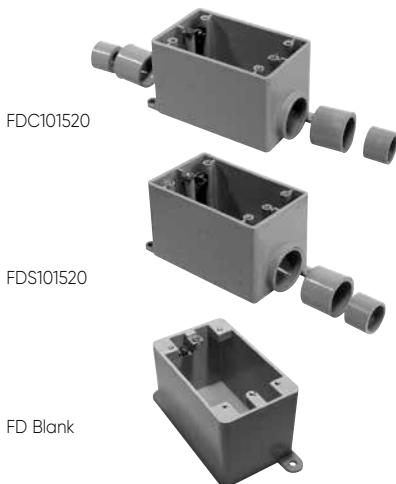

F SERIES SINGLE GANG DEEP BOXES

Outside Dimensions:
Height, 4 9/16" - Width, 2 13/16" - Depth 2 3/4", Cubic Inches = 35.30
With the exception of the FD Blank Box, Scepter FD Series Single Gang Deep Boxes are molded with 1" conduit hubs and supplied with reducer bushings. The conduit hub(s) are field modified as 1/2", 3/4" or 1" to accommodate job-site requirements. The appropriate quantity of 1" x 3/4" and 3/4" x 1/2" reducers to create the desired hub size are packaged with each FD Series Single Gang Deep Box.

Hub Size (inches)	Part Number	Product Code	Volume (in ³)
1/2, 3/4, 1	FDC101520	077291	26.0
1/2, 3/4, 1	FDS101520	077299	26.8
BLANK	FD BLANK	077603	29.2
347 VOLT	FD347	077610	29.2

Note: 10 = 1/2" Hub, 15 = 3/4" Hub, 20 = 1" Hub

SCEPTER PRODUCTS

F SERIES UNIVERSAL DOUBLE GANG BOXES – NEW Style

FS-2 cu.in = 39.5, FSC-2 & FSS-2 cu.in. = 37.0, FSCC-2 cu.in. = 36.0 With the exception of the FD-2 Blank Box, Scepter F Series Double Gang Boxes are molded with 1" conduit hubs and supplied with reducer bushings. The conduit hub(s) are field modified as 1/2", 3/4" or 1" to accommodate job-site requirements. The appropriate quantity of 1" x 3/4" and 3/4" x 1/2" reducers to create the desired hub size are packaged with each F Series Double Gang Box.



Hub Size (inches)	Part Number	Product Code
1/2, 3/4, 1	FSU-2-101520	077364
1/2, 3/4, 1	FSCU-2-101520	077368
1/2, 3/4, 1	FSSU-2-101520	077372
1/2, 3/4, 1	FSCCU-2-101520	077369
Blank	FDU-2	077649

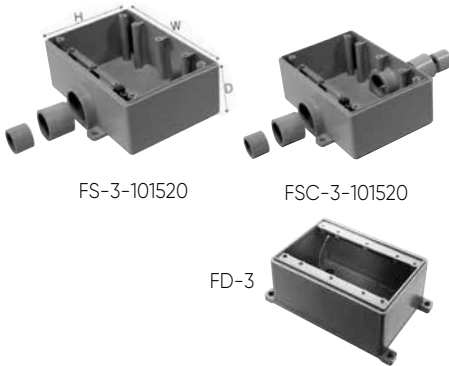
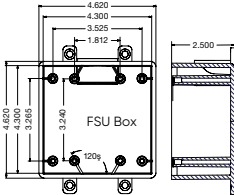

F SERIES TRIPLE GANG BOXES

With the exception of the FD-3 Blank Box, Scepter F Series Triple Gang Boxes are molded with 1" conduit hubs and supplied with reducer bushings. The conduit hub(s) are field modified as 1/2", 3/4" or 1" to accommodate job-site requirements.

The appropriate quantity of 1" x 3/4" and 3/4" x 1/2" reducers to create the desired hub size are packaged with each F Series Triple Gang Box.

Hub Size (inches)	Part Number	Product Code
1/2, 3/4, 1	FS-3-101520	077337
1/2, 3/4, 1	FSC-3-101520	077438
Blank	FD-3	077737

OCTAGONAL BOXES*

Octagonal Boxes are shipped complete with cover, gasket, 4 reducing bushings (3/4" x 1/2"), and 4 sealing caps to be installed from inside box to seal off unused entry hubs.

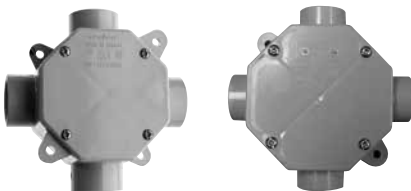

Size (inches)	Part Number	Hub Size (inches)	Product Code
4 x 1-1/2	OB15/10	1/2 - 3/4	077983*
4 x 2-1/8	OB20	1	077984*

Note: Octagonal Boxes are not designed for supporting light fixtures.

OCTAGONAL BOX EXTENSION RINGS



Size (inches)	Part Number	Product Code
4 x 1 deep	XR20	077989
4 x 2 deep	XR35	077990

F SERIES - SINGLE GANG PLATES



Description	Part Number	Product Code
Duplex Receptacle	DRC15/10	077617
Toggle Switch	TSC15/10	077616
Single Receptacle	20RC15/10	077618
Single Receptacle	20-3RC15/10	077619
Single Receptacle	30-3RC15/10	077620
Blank c/w Gasket	BRC15/10	077611
PVC Gasket	GASK15/10	077621

F SERIES - DOUBLE GANG PLATES - Old Style

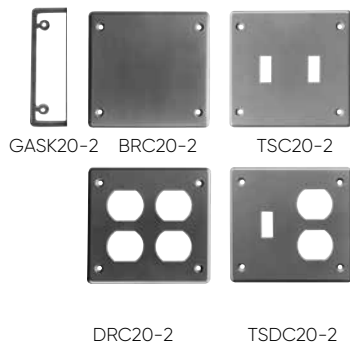

Description	Part Number	Product Code
Blank Cover c/w Gasket	BRC20-2	077614
Double Switch	TSC20-2	077738
Double Duplex Receptacle	DRC20-2	077740
Combo Switch Duplex Receptacle	TSDC20-2	077739
PVC Gasket	GASK20-2	077743

F SERIES - UNIVERSAL DOUBLE GANG PLATES - NEW Style (only fits new style double gang boxes)

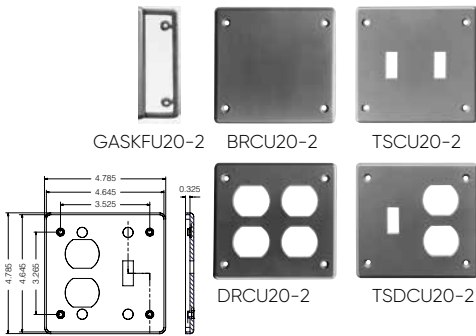

Description	Part Number	Product Code
Blank Cover c/w Gasket	BRCU20-2	077359
Double Switch	TSCU20-2	077373
Double Duplex Receptacle	DRCU20-2	077362
Combo Switch Duplex Receptacle	TSDCU20-2	077374
PVC Gasket	GASKFU20-2	172650

F SERIES - TRIPLE GANG PLATES

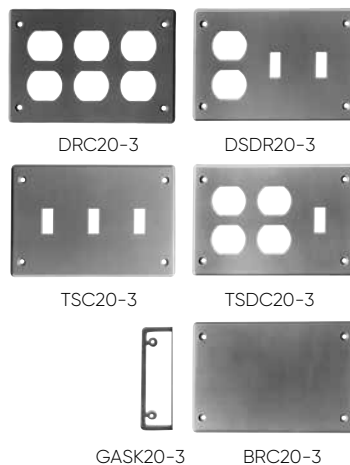

Description	Part Number	Product Code
Triple Receptacle	DRC20-3	077747
Combo Switch Receptacle	DSDR20-3	077745
Triple Switch	TSC20-3	077744
Combo Switch Receptacle	TSDC20-3	077746
Blank Cover c/w Gasket	BRC20-3	077748
PVC Gasket	GASK20-3	077749

SCEPTER PRODUCTS

SINGLE GANG WEATHERPROOF COVERS



Description	Device Opening	Part Number	Product Code
Plunger-style Switch Cover		VPT15/10	077630
Toggle Switch Cover		VSC15/10	077612
Grey Toggle Switch Cover		WTG15/10	077606
Grey Duplex Receptacle		WDR15/10	077993
White Duplex Receptacle		RWDR15/10	077786
Grey Ground Fault Receptacle		WGF15/10	077785
White Ground Fault Receptacle		RWGF15/10	077787
Single Receptacle Device 15 AMP	1.375	WTL15	077992
Single Receptacle Device 20 AMP	1.625	WTL20	077994
Single Receptacle Device 30 AMP	1.722	WTL30	077991
Single Receptacle Device 50 AMP	2.187	WTL50	077951
Grey Double Door Duplex Receptacle		WDRE15/10	077087
White Double Door Duplex Receptacle		RWDRE15/10	077408
Gasket for W Series Cover (except WDRE & RWDR)		GASKW	077755
Gasket for WDRE & RWDRE Covers		GASKDD	072225

* Gaskets are included with all weatherproof covers.

DOUBLE GANG WEATHERPROOF COVERS



Description	Part Number	Product Code
Toggle Switch Cover	VSC20-2	077741
Combination Switch Cover & GFI Receptacle	VSRC20-2	077742
Combination Switch Cover & Duplex Receptacle	VSDR20-2	077752
Combination Switch Cover & Single Receptacle	VSRR20-2	077753
Double Door GFCI Cover	VSGG20-2	077096
Double Door Duplex Cover	VSDD20-2	077097
Gasket for Double Gang (except VSGG20-2 & VSDD20-2)	GASK20-2	077743
Gasket for VSGG20-2 and VSDD20-2 Double Gangs	GASKV20-2	072227

* Gaskets are included with all weatherproof covers.

* VSGG20-2 and VSDD20-2 are universal and will fit on most PVC and metal boxes.

F SERIES - DOUBLE GANG WEATHERPROOF COVERS - NEW Style (only fits new style double gang boxes)

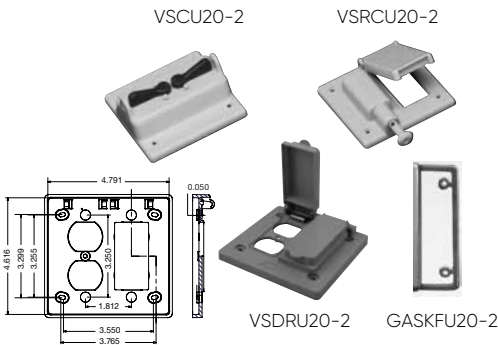

Description	Part Number	Product Code
Toggle Switch Cover	VSCU20-2	077376
Combination Switch Cover & GFI Receptacle	VSRCU20-2	077357
Combination Switch Cover & Duplex Receptacle	VSDRU20-2	077356
Gasket	GASKFU20-2	172650

SCEPTER PVC ROUND FLOOR BOX

Suitable for slab-on-grade, below grade and wood floor construction, Scepter PVC round floor boxes and accessories enable contractors to collectively run in-floor power, data and communications wiring to a single box for significant savings in time and materials.

Installation is quick and simple, with our nonmetallic floor box and covers, saving both time and money over similar metallic assemblies.

Scepter's floor box and duplex receptacle covers are constructed from high impact, noncorroding and nonconducting PVC. The flush-mount covers are available in custom colors and are shipped with a levelling ring complete with a grounding clip. Metal cover adapter kits are also available, allowing you to adapt to metal floor plates. Our 6" deep floor box allows flexibility for various concrete floor pours, while our 4-3/4" width offers easy access and ample wire room. The box comes complete with 2 - 1" and 2 - 3/4" hub openings. All boxes are shipped complete with reducer plugs for added versatility.

Complete technical information available at www.ipxelectrical.com – Nonmetallic Floor Box & Accessories Technical Manual.



FB

Description

Floor Box Base

(includes disposable protective cap and reducer plugs)

Part Number Product Code

FB 076954



FBS-KIT

Floor Box Base c/w Leveling Ring Adapter

(includes disposable protective cap, reducer plugs and leveling ring adapter)

FBKIT 077068



AFMC

Floor Box Stand Kit (includes FB Box)

(is equipped with several height brackets which accommodate the different rebar and post-tension cable heights and slab depths found from job-site to job-site.)

FBS-KIT 077700

Metal Cover Adapter Kit

(includes levelling ring, metal cover adapter and 2 gaskets)

AFMC 076953



LRA-U

Universal Leveling Ring Adapter

LRA-U 076606



FBDRCB

Floor Box Duplex Receptacle Cover (Nonmetallic)

(includes flush mount cover, blank cover & gasket)

Brown FBDRCB 076943

Gold FBDRCG 076942

Grey FBDRCGr 076941

Light Almond FBDRCA 076940



FBUDK

Tri-Service Universal Divider Kit

(includes upper and lower dividers, riser tube and 2 grommets)

FBUDK 077948



FBYC

Y Connector (3/4")

FBYC 077499

SCEPTER PRODUCTS

BRASS AND NICKEL COVER PLATES

These cover plates help to protect enclosed power data and communications wiring from daily environmental floor conditions such as mopping (UL scrub water tested) and foot traffic (UL approved for cover loading).

The covers feature a light lacquer finish for extra strength and durability in high traffic areas and include a rubber gasket and aluminum backing plate to create a water-tight seal. The flush mount cover plates should be installed to the floor box using the LRA-U.



DFL-2-N



SSC-N



DSC-N

NICKEL COVER PLATES

Description	Part Number	Product Code
Duplex Receptacle Cover with Dual Flip Lid	DFL-2-N	178279
Duplex Receptacle Cover with Individual Screw Plug Openings	SSC-N	178278
Combination 2" x 1/2" Single Screw Plug Opening	DSC-N	178280



DFL-2



SSC



DSC-N

BRASS COVER PLATES

Description	Part Number	Product Code
Duplex Receptacle Cover with Dual Flip Lid	DFL-2	178096
Duplex Receptacle Cover with Individual Screw Plug Openings	SSC	178093
Combination 2" x 1/2" Single Screw Plug Opening	DSC	178091
Combination 2" x 1/2" Single Screw Plug and 1/2" Datacomm Opening	DSC-P/C	178092

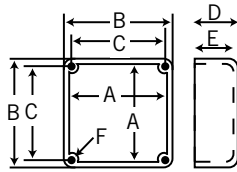

FABRICATED BOXES

Unflanged PVC fabricated boxes of any size may be made to customers' specifications and come complete with lids, gaskets and screws. These boxes are not CSA certified and are not returnable.

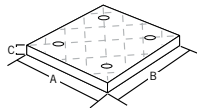

FLANGED BOX W FIBRE-REINFORCED SAFETY TREAD COVER

Scepter's JB Flanged 'H' Series Junction Boxes feature a fiber-reinforced safety tread cover which uses a recessed Hex Key fastening hardware for a simple installation while reducing the opportunity for tampering.



Part Number	Product Code	Box ID (inches)			Lid Dimensions (inches)			Volume (in ³)
		L	W	D	A	B	C	
H664	077685	6	6	4-1/4	9.0	9.0	0.60	138.0
H666	077686	6	6	6-1/4	9.0	9.0	0.60	211.0
H884	077687	8	8	4-1/4	11.5	11.5	0.75	248.0
H886	077688	8	8	6-1/4	11.5	11.5	0.75	434.0
H887	077689	8	8	7-1/4	11.5	11.5	0.75	434.0
H887-A	077692	8	8	7-1/4	11.5	11.5	0.75	434.0

These boxes are not CSA Certified and are not returnable.

JUNCTION BOX ADAPTERS

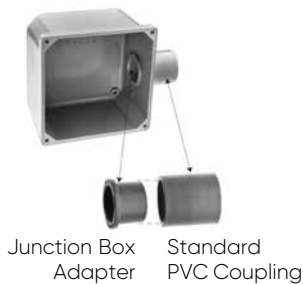

Size (inches)	Part Number	Product Code	ID	OD (inches)	L	OL
1/2	JBA10	077721	0.62	1.20	0.81	0.95
3/4	JBA15	077722	0.79	1.40	0.87	1.01
1	JBA20	077723	1.00	1.58	0.89	1.06
1-1/4	JBA25	077724	1.35	1.98	1.12	1.30
1-1/2	JBA30	077725	1.59	2.37	1.10	1.33
2	JBA35	077726	2.05	2.85	1.25	1.54
2-1/2	JBA40	077727	2.45	3.34	1.68	1.99
3	JBA45	077728	3.05	3.10	1.77	2.11
3-1/2	JBA50	077729	3.54	4.50	2.09	2.41
4	JBA55	077730	4.02	5.03	1.99	2.30

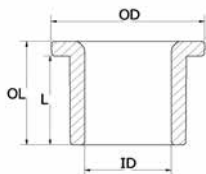

SCEPTER JBOX

The EASIEST Junction Box you'll EVER use

The frustrations are gone – no more worries about positioning a gasket or over-tightening a cover screw, and no more loose parts to misplace before installation. We've added features to make the installation of a junction box faster and easier; whether locating and aligning conduit entry holes, easily mounting the box to a wall or pole or installing a cover with only one hand, you will appreciate the design features.

The original junction box is completely redesigned and features have been added to make the Scepter® JBox™, the Next Generation Junction Box the easiest box to use. The patent pending integral gasket, non-metallic fasteners, molded mounting feet, embossed grid-lines and flat cover features have been engineered to provide a contractor-friendly junction box.

The Scepter JBox is ideally suited for indoor and outdoor use and made to perform in the most demanding environments. Made of PVC it is extremely durable and resistant to impact in a wide range of temperatures and not adversely affected by water and chemicals. Built for corrosive environments, the Scepter JBox is entirely non-metallic, eliminating corrosion concerns with screws and other metal parts.



APPLICATIONS

- CORROSIVE ENVIRONMENTS
- MARINE & CAR WASHES
- WASH DOWN
- AGRICULTURAL
- WASTE-WATER TREATMENT FACILITIES



ADVANTAGES

ZERO FOOTPRINT

Design allows for installation in corners and immediately adjacent to other products. There is easy access to all mounting feet and fasteners.

INSTALLING OVERHEAD

Integral fasteners allow for easy overhead positioning and securing.

MOUNTING IN A COVER

Pilot lights, control switches and other devices are easily mounted. The Cover is free and clear of supporting ribs, and has a uniform thickness.

ADDED SECURITY

Sizes 6" and larger feature a lock-out option. Tie-wrap, tamper resistant bolt or padlock will restrict access to the box.

MORE INTERIOR VOLUME

Increased space from wire pulling and for ease of bend radius. The increased cubic inch volume allows for more flexibility



SCEPTER JBOX

FEATURES & BENEFITS

FASTENERS

- Close by hand – tool assist to open
- 100% non-metallic – corrosion resistant material
- No loose hardware for easy installation



LOCK-OUT OPTION

- Available on sizes 6" to 16"
- Use a tie-wrap, bolt or padlock for added security



INTEGRATED GASKET

- Injection molded gasket permanently fixed to the cover –no installation required
- Proprietary gasket material creates a 6P rated enclosure FLAT COVER
- No ribs – offers a flat, smooth surface for mounting of devices or labels
- No engravings



BACK PANEL

- Designed to fit sizes 6" and 16"
- Made of 14 gauge carbon steel
- White epoxy powder-coated finish
- Easy to cut and drill to mount devices



GRIDLINES

- Easy reference for drilling knockouts
- Makes conduit alignment a snap
- Indicates a "drill zone"



MOUNTING FEET

- Molded –no loose parts to assemble
- Located on corners out of the way of conduit connections
- Flush with the back of the box for close surface mounting
- Integrated design of mounting feet offers improved strength

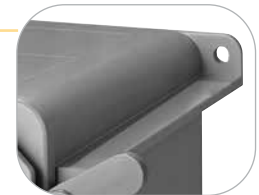

POLE MOUNTING KIT

- One kit fits 4" to 16"
- Supplied as a complete kit
- Works with wood, concrete, steel and composite poles
- Installs on round, square & octagonal poles up to 15" diameter



PERFORMANCE RATINGS

MAXIMUM TEMPERATURE RANGE: Maximum ambient temperatures to 122°F (50°C) as per the NEC

RECOMMENDED OPERATING TEMPERATURE: -40°F to 122°F (-40°C to 50°C)

UV AND WATER EXPOSURE RATING: UL 746C approved for exposure to UV and water

FLAME & SMOKE RATING: UL 94V-0 (UL94 Vertical Flame Test)

NEMA ENCLOSURE RATINGS: The Scepter JBox is NEMA Rated 1, 2, 3R, 4, 4X, 6*, 6P*, 12, 13
(*Applies only to sizes 4" to 12" non-hinged covers)

INDUSTRIAL CONTROL PANELS UL 508A: Suitable to be used as an enclosure per section 18 of UL 508A

CONDUCTORS: Suitable for use with 90°C Rated Conductors

NEMA RATING

Type	Description
1	Enclosures for indoor use providing protection from contact with the enclosed equipment and ingress of solid objects (falling dirt).
2	Enclosures for indoor use providing protection from contact with the enclosed equipment, ingress of solid objects (falling dirt) and from harmful effects on equipment due to ingress of water (dripping and light splashing)
3R	Enclosures for indoor or outdoor use providing protection from contact with the enclosed equipment, ingress of solid objects (falling dirt) and from harmful effects on equipment due to ingress of water (rain, sleet, snow) and is undamaged by the external formation of ice.
4	Enclosures for indoor or outdoor use providing protection from contact with the enclosed equipment, ingress of solid objects (falling dirt and windblown dust) and from harmful effects on equipment due to ingress of water (rain, sleet, snow, splashing water and hose directed water) and is undamaged by the external formation of ice.
4X	Enclosures for indoor or outdoor use providing protection from contact with the enclosed equipment, ingress of solid objects (windblown dust) and from harmful effects on equipment due to ingress of water (rain, sleet, snow, splashing water and hose directed water), protection against corrosion and is undamaged by the external formation of ice.
6	Enclosures for indoor or outdoor use providing protection from contact with the enclosed equipment, ingress of solid objects (falling dirt) and from harmful effects on equipment due to ingress of water (hose directed water and entry of water on occasional temporary submersion at a limited depth) and is undamaged by the external formation of ice.
6P	Enclosures for indoor or outdoor use providing protection from contact with the enclosed equipment, ingress of solid objects (falling dirt) and from harmful effects on equipment due to ingress of water (hose directed water and entry of water during prolonged submersion at a limited depth) and is undamaged by the external formation of ice.
12	Enclosures for indoor use providing protection from contact with the enclosed equipment, ingress of solid objects (falling dirt circulating dust, lint, fibers and flyings) and from harmful effects on equipment due to ingress of water (dripping and light splashing).
13	Enclosures for indoor use providing protection from contact with the enclosed equipment, ingress of solid objects (falling dirt circulating dust, lint, fibers and flyings) and from harmful effects on equipment due to ingress of water (dripping and light splashing) and against the spraying, splashing and seepage of oil and non-corrosive coolants.

SCEPTER JBOX PRODUCTS

PRODUCT DIMENSIONS

Size inches	Part Number	Product Code	L1	W1	L2	W2	H1	H2	M1	M2	G1	G2	J1	J2	D	K	Vol.
			inches														
4x4x2	JBX442	277000	4.97	3.93	3.48	3.48	2.90	2.52	4.48	3.44	2.41	1.09	1.72	1.09	0.51	0.24	25.55
4x4x4	JBX444	277001	4.90	3.86	3.48	3.48	4.89	4.52	4.41	3.37	2.22	2.97	1.59	2.97	0.59	0.24	50.11
5x5x2	JBX552	277002	5.97	4.93	4.93	4.55	2.90	2.52	5.48	4.44	3.41	1.09	2.69	1.09	0.51	0.24	41.89
6x3x4	JBX634	277003	3.90	5.86	5.86	5.48	4.89	4.52	3.41	5.37	1.22	2.72	3.42	2.72	0.59	0.28	56.03
6x6x4	JBX664	277004	7.58	7.58	7.58	7.20	4.90	4.52	6.90	6.90	4.47	2.47	4.47	2.47	0.59	0.28	172.05
6x6x6	JBX666	277005	7.51	7.51	7.51	7.13	6.90	6.52	6.83	6.83	4.22	4.47	4.22	4.47	0.72	0.28	255.00

NEMA Rated for JBox with Standard Cover 4" - 6"
1,2,3R,4,4X,6,6P,12,13

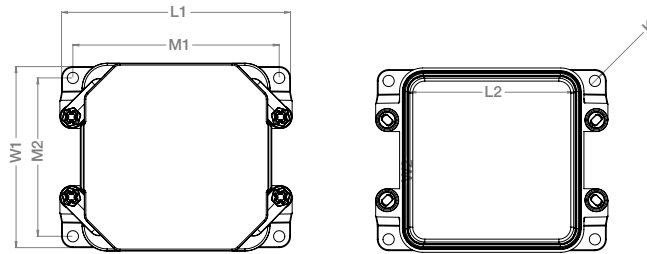

JBX442 - JBX666

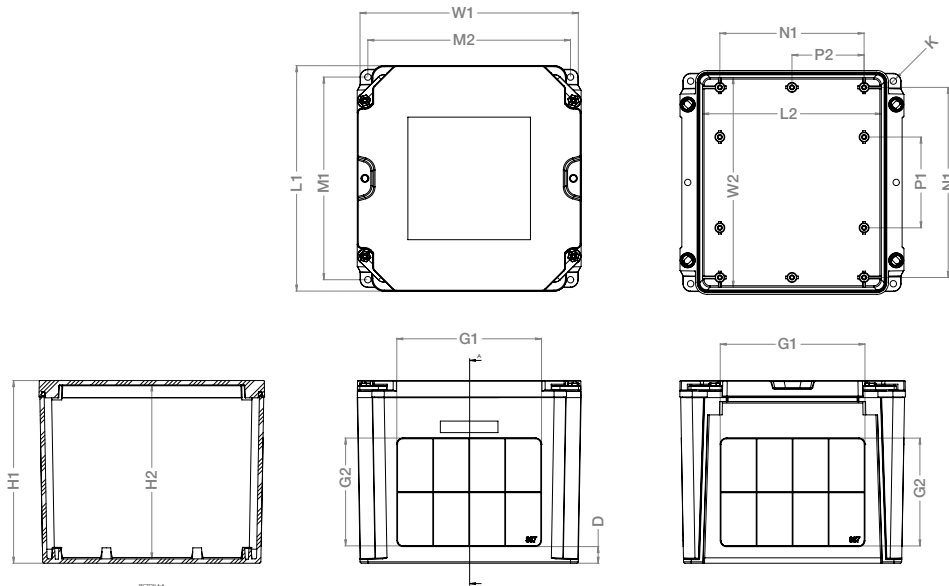

JBX884 - JBX887

Size inches	Part Number	Product Code	L1	W1	L2	W2	H1	H2	M1	M2	G1	G2	N1	N2	P1	P2	D	K	Vol.
			inches																
8x8x4	JBX884	277006	9.58	9.58	7.86	9.20	4.90	4.52	8.90	8.90	6.47	1.97	8.25	6.26	3.94	3.13	0.59	0.28	293.19
8x8x7	JBX887	277007	9.47	9.47	7.76	9.10	7.90	7.52	8.90	8.90	6.22	4.65	8.25	6.26	3.94	3.13	0.75	0.28	506.97
12x12x4	JBX12124	277008	13.58	12.24	11.74	11.74	4.90	4.46	12.90	11.56	9.28	2.03	10.26	10.25	3.94	3.13	0.56	0.28	548.26
12x12x6	JBX12126	277009	13.58	12.24	11.74	11.74	6.90	6.46	12.90	11.56	9.03	3.78	10.26	10.25	3.94	3.13	0.67	0.28	822.21
12x12x8	JBX12128	277010	13.58	12.24	11.74	11.74	8.90	8.46	12.90	11.56	8.81	5.64	10.26	10.25	3.94	3.13	0.76	0.28	1092.90
14x14x8	JBX14148	277011	15.72	14.39	13.80	13.80	9.10	8.61	15.10	13.70	11.05	5.69	12.25	10.26	3.94	3.16	0.83	0.33	1535.00
14x14x10	JBX141410	277012	15.72	14.39	13.80	13.80	11.10	10.52	15.10	13.70	11.05	7.55	12.25	10.26	3.94	3.16	0.83	0.33	1916.00
16x16x10	JBX161610	277013	17.64	16.30	15.71	15.71	11.10	10.52	17.00	15.60	12.55	7.55	14.25	12.26	4.71	4.09	0.83	0.33	2520.00

NEMA Rated for JBox with Standard Cover 8" - 12"
1,2,3R,4,4X,6,6P,12,13

NEMA Rated for JBox with Standard Cover 14" & 16"
1,2,3R,4,4X,12,13

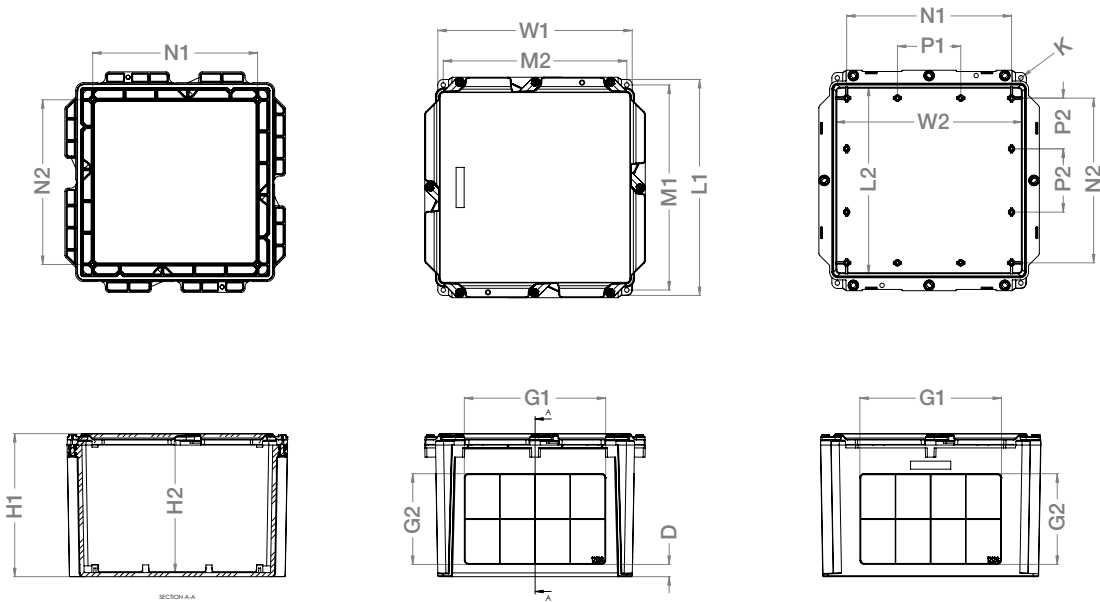

JBX12124 - JBX12128

Size inches	Part Number	Product Code	W	H	A	B	C
			inches				
6x6	BP66CSW	077864	4.88	6.75	4.26	6.25	0.25
8x8	BP88CSW	077861	6.88	8.75	6.26	8.25	0.25
12x10	BP1210CSW	077862	8.88	10.75	8.26	10.25	0.25
12x12	BP1212CSW	077865	10.88	10.75	10.26	10.25	0.25
14x14	BP1414CSW	077867	10.88	12.75	10.26	12.25	0.25
16x16	BP1616CSW	077868	12.88	14.75	12.26	14.25	0.25

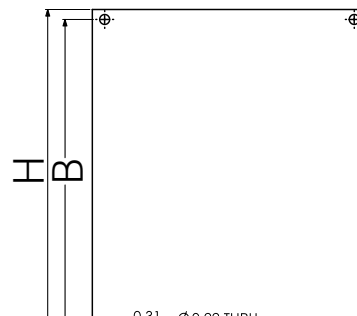

BACK PANELS
BP88CSW - BP1212CSW

SCEPTER JBOX HINGED COVER

Tested to perform in industrial environments, the Scepter JBox Hinged Cover junction box has added features to make this the easiest box to use – no matter the situation.

The Hinged Cover opens more than 200° for complete and easy access to control devices and instruments and is designed to work with your existing PVC conduit runs. The Scepter JBox Hinged Cover is NEMA 3R and 4X rated, ideally suited for indoor and outdoor use and in wash-down environments. It is 100% non-metallic and includes all the features that users have come to appreciate in the Scepter JBox.



PRODUCT DIMENSIONS

Size inches	Part Number	Product Code	L1	W1	L2	W2	H1	H2	M1	M2	G1	G2	N1	N2	P1	P2	D	K	Vol.
			inches																
8x8x4	JBXH884	277100	9.58	9.58	7.86	9.20	4.90	4.52	8.90	8.90	6.47	1.97	8.25	6.26	3.94	3.13	0.59	0.28	293.19
8x8x7	JBXH887	277101	9.47	9.47	7.86	9.20	7.90	7.52	8.90	8.90	6.22	4.65	8.25	6.26	3.94	3.13	0.75	0.28	506.97
12x10x6	JBXH12106	277102	11.51	12.17	9.67	11.67	6.90	6.46	10.80	10.80	8.03	3.78	10.25	8.26	3.94	2.16	0.67	0.28	682.15
12x12x4	JBXH12124	277103	13.58	12.24	11.74	11.74	4.90	4.46	12.90	12.90	9.28	2.03	10.26	10.25	3.94	3.13	0.56	0.28	548.26
12x12x6	JBXH12126	277104	13.58	12.24	11.74	11.74	6.90	6.46	12.90	12.90	9.03	3.78	10.26	10.25	3.94	3.13	0.67	0.28	822.21
12x12x8	JBXH12128	277105	13.58	12.24	11.74	11.74	8.90	8.46	12.90	12.90	8.81	5.64	10.26	10.25	3.94	3.13	0.76	0.28	1092.9
14x14x8	JBXH14148	277106	15.72	14.39	13.80	13.80	9.10	8.46	15.10	15.10	11.05	5.69	12.25	10.26	3.94	3.16	0.83	0.33	1535.0
14x14x10	JBXH141410	277107	15.72	14.39	13.80	13.80	11.10	10.52	15.10	15.10	11.05	7.55	12.25	10.26	3.94	3.16	0.83	0.33	1916.0
16x16x10	JBXH161610	277108	17.64	16.3	15.71	15.71	11.1	10.52	17	17	12.55	7.55	14.25	12.26	4.71	4.09	0.83	0.33	2520.0

NEMA Rated for JBox with Hinged Cover
1,2,3R,4,4X,12,13

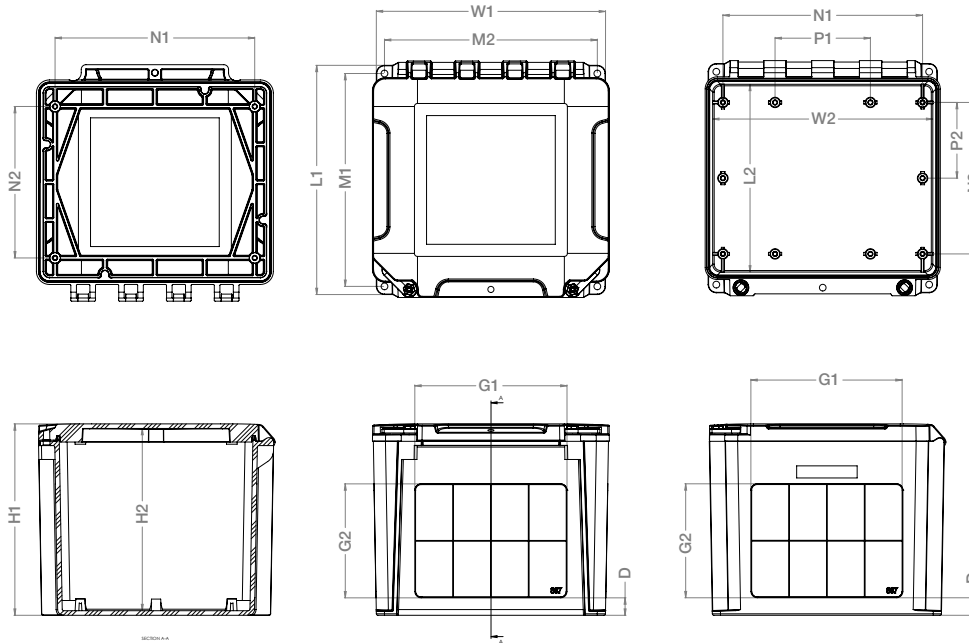

JBXH884 - JBXH887

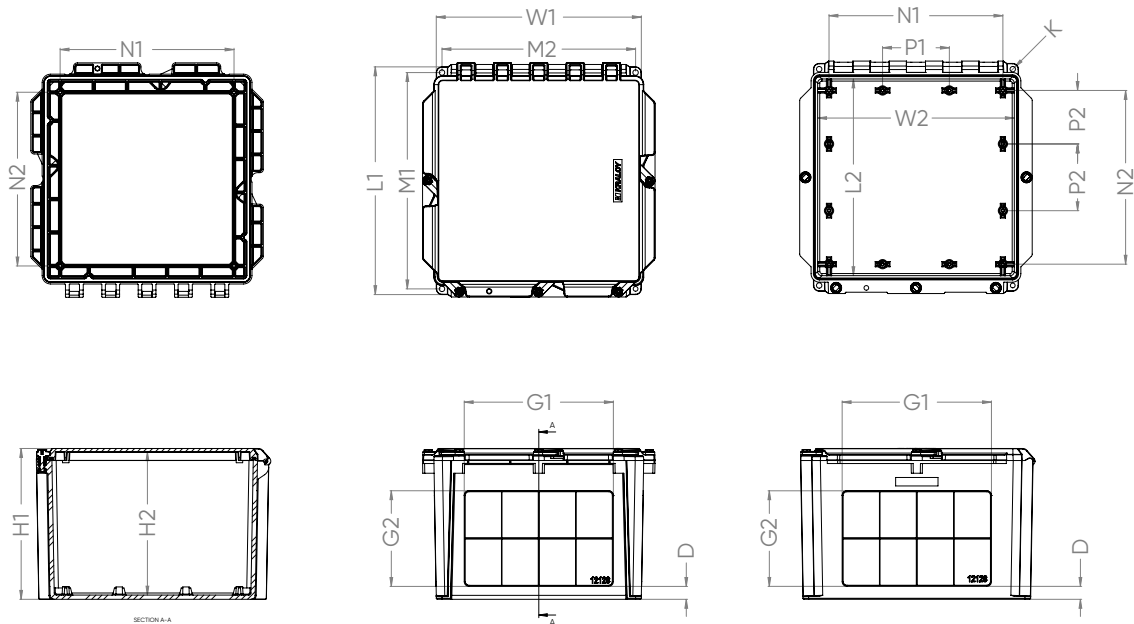

JBXH12106 - JBXh12128

EPR KITS FOR CONDUIT REPAIR

REPAIRS CONDUIT as easy as 1-2-3

These clever and innovative conduit repair kits from IPEX are the first total repair systems for broken and damaged PVC conduit. They offer fast and easy repairs for damaged conduit caused by actions such as earth excavation, horizontal and core drilling.

EPR Kits are manufactured of high-impact and non-conductive PVC, ensuring a life long quality repair for your system. All sizes are 24 inches in length.

With unique interlocking joints, the EPR Kits' two half shell bell by bell pieces simply close around the installed wire and cable. Using standard PVC solvent cement, EPR Kits are quickly and easily assembled and connected, restoring the conduit to its original form. And, unlike other conduit repair systems, EPR Kits are capable of repairing various lengths and types of pipe quickly and accurately, saving you time and money.

STEPS 1-2-3

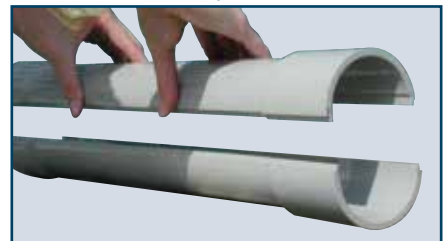
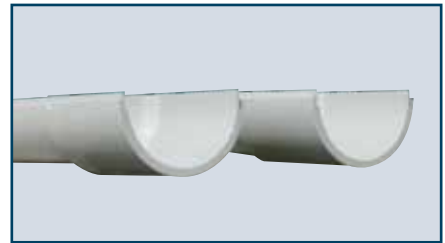

ADVANTAGES

RESTORES structural integrity of conduit system

COST SAVINGS with fast and easy installation

COMPATIBILITY – inside diameter of bell equals outside diameter of pipe to create a bell and spigot connection

SPECIAL INTERLOCKING JOINTS provide water-tight seal

PACKAGING includes easy to follow instruction sheet

IDEAL FOR THE REPAIR OF RIGID PVC CONDUIT in electrical, telecommunication, utility and CATV applications

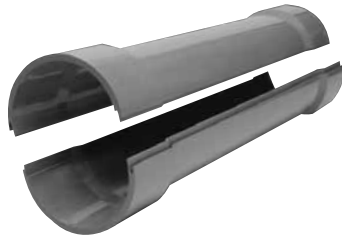

EPR KITS FOR CONDUIT REPAIR

Size (in)	Part Number	Product Code	Length (in)
1-1/4	EPR25	077982	24
1-1/2	EPR30	077981	24
2	EPR35	077980	24
2-1/2	EPR40	077960	24
3	EPR45	077958	24
4	EPR55	077957	24
5	EPR60	077956	24
6	EPR65	077955	24

SALES AND CUSTOMER SERVICE

Customers call IPEX Electrical Inc.

Toll free: (866) 473-9462

www.ipexna.com

About the IPEX Group of Companies

As leading suppliers of thermoplastic piping systems, the IPEX Group of Companies provides our customers with some of the largest and most comprehensive product lines. All IPEX products are backed by more than 50 years of experience. With state-of-the-art manufacturing facilities and distribution centers across North America, we have earned a reputation for product innovation, quality, end-user focus and performance.

Markets served by IPEX group products are:

- Electrical systems
- Telecommunications and utility piping systems
- PVC, CPVC, PP, PVDF, PE, ABS, and PEX pipe and fittings
- Industrial process piping systems
- Municipal pressure and gravity piping systems
- Plumbing and mechanical piping systems
- Electrofusion systems for gas and water
- Industrial, plumbing and electrical cements
- Irrigation systems

Product is manufactured by IPEX Electrical Inc.

JBox™ is a trademark of IPEX Branding Inc.

This literature is published in good faith and is believed to be reliable. However it does not represent and/or warrant in any manner the information and suggestions contained in this brochure. Data presented is the result of laboratory tests and field experience.

A policy of ongoing product improvement is maintained. This may result in modifications of features and/or specifications without notice.



BRELSCIP190401CR7
© 2023 IPEX EL0021



DISTRIBUTED BY