

Fire-Rated Poke-Throughs SystemOne Recessed Cover

HUBBELL

Features

- 180 degree cover opening to lay flat and reduce tripping hazards
- Two large cable egress doors
- Die cast aluminum cover construction for enhanced durability
- ADA Compliant
- Plated Finish

Ordering Information

- Compatible with S1R6PTFIT

Catalog Number S1R6CVRBRS	UPC Number 783585443492	Style Surface
Finish Brass Plated	Flange Diameter 7.5 Inches	Finished Floor Insert No

Listings

cULus Listed
UL scrub water compliant
UL 514A Listed

Specifications

Cover Material	Die Cast Aluminum
Flange height	0.13 in.
Load Rating	1000 lbs. static load through 3" diameter mandrel (w/ 2x safety factor)

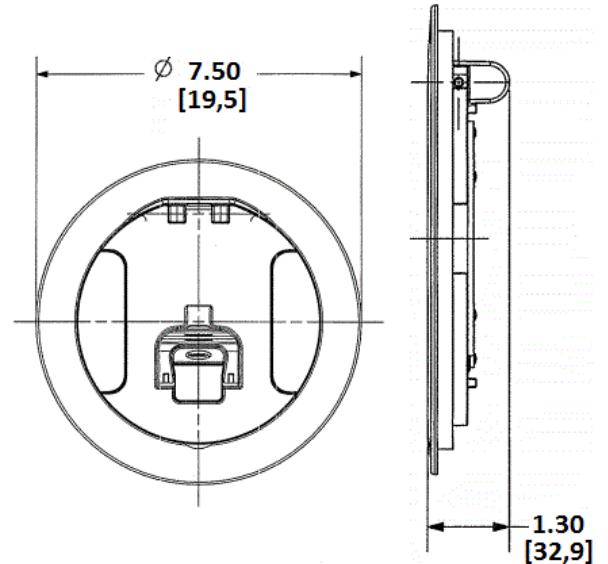

Online Resources

Customer Use Drawing
eCatalog
Installation Instructions

Dimensions in Inches (mm)

Hubbell Wiring Device-Kellems • Hubbell Incorporated (Delaware) • 40 Waterview Drive • Shelton, CT 06484

Phone (800) 288-6000 • Fax (800) 255-1031 • Specifications subject to change without notice.

