

Installation Instructions for GD/GWF Molded Case Circuit Breakers and Switches

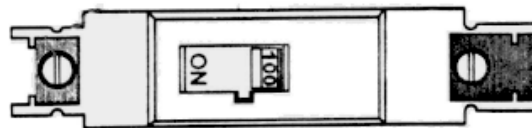

Contents

Description	Page
Introduction	2
Installation	2
Manual Operation	5
Inspection and Field Testing	5

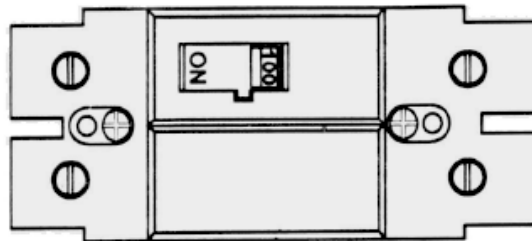
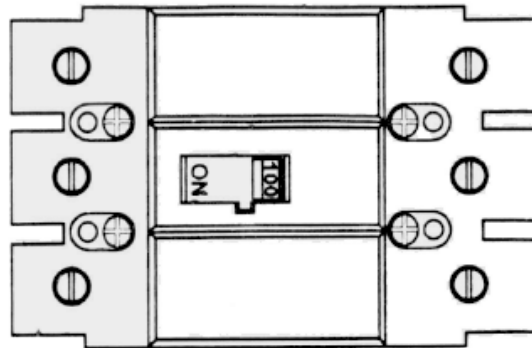

WARNING

DO NOT ATTEMPT TO INSTALL OR PERFORM MAINTENANCE ON EQUIPMENT WHILE IT IS ENERGIZED. SEVERE PERSONAL INJURY, DEATH, OR SUBSTANTIAL PROPERTY DAMAGE CAN RESULT FROM CONTACT WITH ENERGIZED EQUIPMENT. ALWAYS VERIFY THAT NO VOLTAGE IS PRESENT BEFORE PROCEEDING WITH THE TASK, AND ALWAYS FOLLOW GENERALLY ACCEPTED SAFETY PROCEDURES.

EATON IS NOT LIABLE FOR THE MISAPPLICATION OR MISINSTALLATION OF ITS PRODUCTS.

The user is cautioned to observe all recommendations, warnings, and cautions relating to the safety of personnel and equipment as well as all general and local health and safety laws, codes, and procedures.

The recommendations and information contained herein are based on Eaton experience and judgement, but should not be considered to be all-inclusive or covering every application or circumstance which may arise. If any questions arise, contact Eaton for further information or instructions.

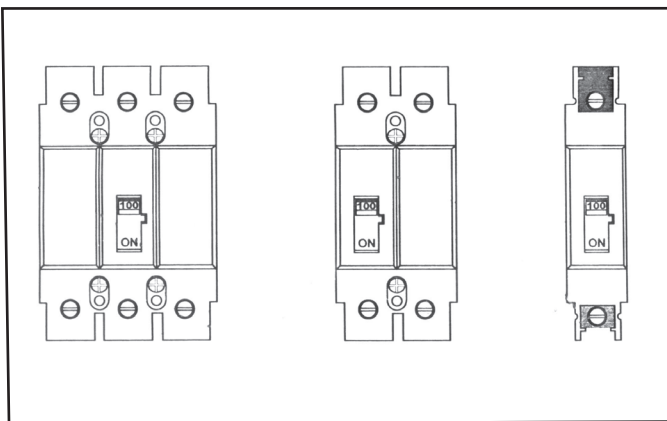

Figure 1-1 GWF 480V, 1, 2, 3 Pole Circuit Breakers; 2 and 3 Pole Molded Case Switches and GD 480V 2 and 3 Pole Circuit Breakers; GD 3 Pole Molded Case Switch

1. INTRODUCTION

GD & GWF circuit breakers (Figure 1-1) are thermal-magnetic devices.

Some styles of circuit breakers have steel terminals as opposed to aluminum terminals. Three methods of mounting these circuit breakers are available: hardware, DIN rail, or base mounting plate.

The following accessories are available for use with GD/GWF circuit breakers:

- * Auxiliary Switch
- * Alarm (Signal)/Lockout switch
- * Shunt Trip
- * Undervoltage Release Mechanism
- * Lock Dog (S# 1294C01H01)
- * Padlockable Handle (S# 1223C77G03, for 1 pole only)

2. INSTALLATION

The installation procedure consists of inspecting and mounting the circuit breaker, connecting and torquing terminations. To install the circuit breaker, perform the following steps.

Note: GD/GWF circuit breakers are factory sealed. Underwriters Laboratories, Inc. Standard requires that internal accessories be installed at the factory.

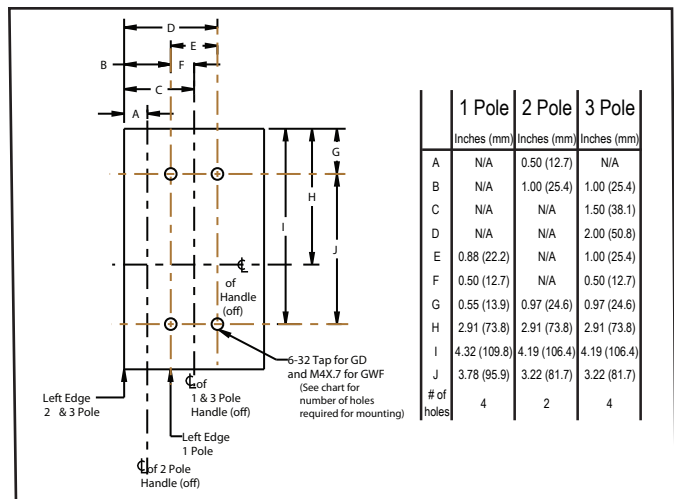

Figure 2-1 Circuit Breaker Mounting Bolt Drilling Plan

Where local codes and standards permit and UL listing is not required, internal accessories can be field installed. Accessory installation should be done before the circuit breaker is mounted and connected.

Mounting hardware is supplied with breaker.

2-1. Make sure that the circuit breaker is suitable for the intended installation by comparing nameplate data with system requirements. Inspect the circuit breaker for completeness, and check for damage before mounting.



WARNING

BEFORE MOUNTING THE CIRCUIT BREAKER IN AN ELECTRICAL SYSTEM, MAKE SURE THE CIRCUIT BREAKER IS SWITCHED TO THE OFF POSITION AND THAT THERE IS NO VOLTAGE PRESENT WHERE WORK IS TO BE PERFORMED. SPECIAL ATTENTION SHOULD BE PAID TO REVERSE FEED APPLICATIONS TO ENSURE NO VOLTAGE IS PRESENT. THE VOLTAGE IN ENERGIZED EQUIPMENT CAN CAUSE SEVERE PERSONAL INJURY OR DEATH.

2-2. To mount the circuit breaker, perform the following steps:

Note: If circuit breaker includes factory installed internal accessories, make sure accessory wiring can be reached when the circuit breaker is mounted.

a. Individual Mounting Panels

Pre-drill panel and tap holes using bolt drilling plan (Figure 2-1). Install circuit breaker using mounting screws and washers. Tighten screws firmly, but do not exceed 15 inch pounds (1.69 N.m.).

b. DIN Rail Mounting

Adapter kit (S# 1225C79G01 for 1 and 2 pole breakers and S# 1225C79G02 for 3 pole breakers) suitable for use with standard 35 millimeter DIN rail (such as 35mm x 7.5 or 35mm x 15 per DIN EN50022), should be pre-assembled to the rear of the circuit breaker as required by snapping adapter onto DIN rail.

c. Base Mounting Plate

Install base mounting plate (S# 207B513G01 - suitable for mounting six 1-pole, three 2-pole, and two 3-pole breakers) with hardware provided. A recess is provided

in the line and load-end of the circuit breaker for mounting to base mounting plate. Clip circuit breaker into retaining clips load-end first.

d. Deadfront Cover

Cut out mounting panel cover to correct escutcheon dimensions (Figure 2-2).



CAUTION

WHEN ALUMINUM CONDUCTORS ARE USED, THE APPLICATION OF A SUITABLE JOINT COMPOUND IS RECOMMENDED TO REDUCE THE POSSIBILITY OF TERMINAL OVERHEATING. TERMINAL OVERHEATING CAN CAUSE NUISANCE TRIPPING AND DAMAGE TO THE CIRCUIT BREAKER.

2-3 After mounting the circuit breaker, line and load terminals and accessory leads should be connected. (See accessory lead identification on side of circuit breaker).

2-4 The line end terminal barriers of GD circuit breakers and molded case switches bend when a screwdriver is inserted to tighten line end terminals. (See Figure 2-3)

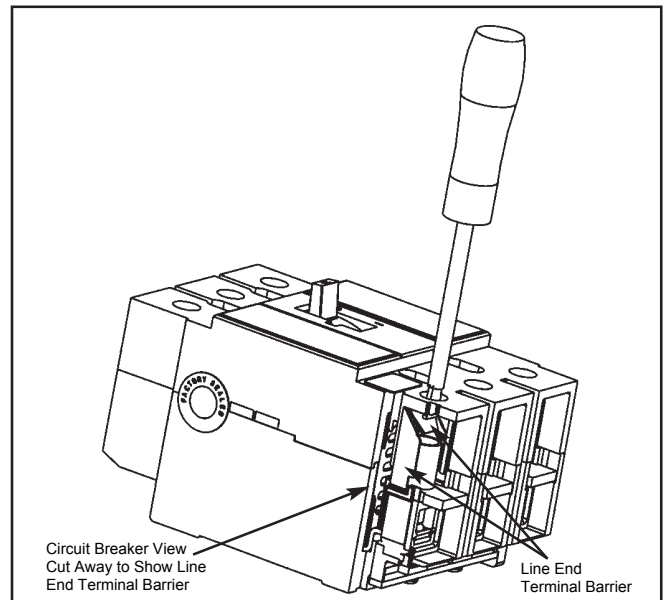

Figure 2-3 Line End Terminal Barrier

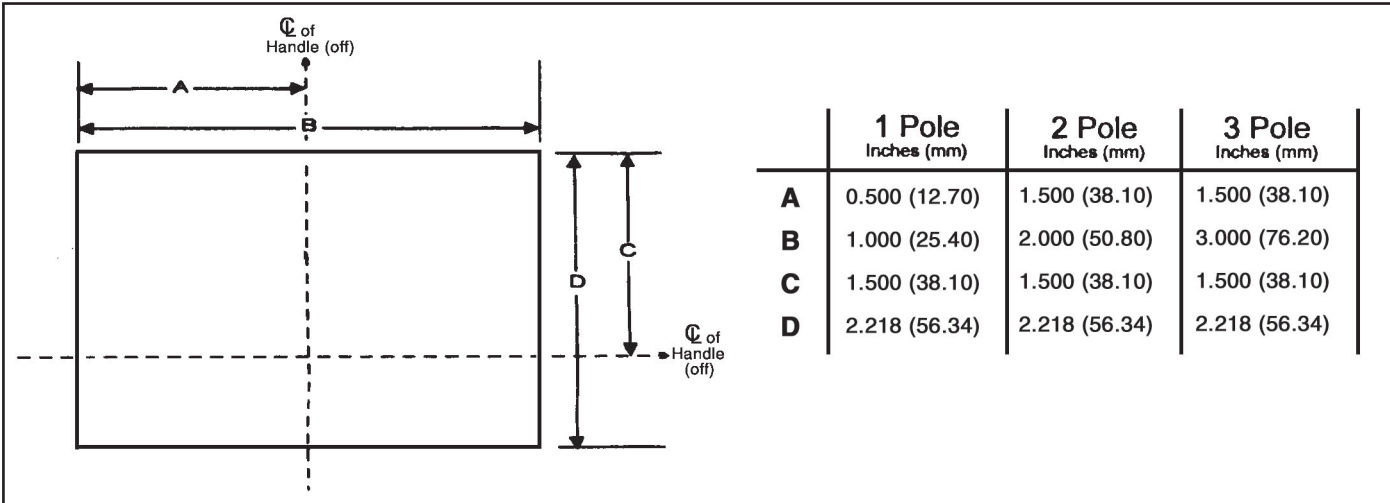

Figure 2-2 Circuit Breaker Escutcheon Dimension

Table 2-1 Terminal Types ②

Circuit Breaker Amps	Terminal Type Material	Screw Head Type	Wire Type	AWG Wire Range	Metric Wire ① Range (mm ²)	Torque Value Lb-in (N.m.)
Use on GD						
15-20	Clamp (Plated Steel) Pressure (Aluminum Body)	Slotted	Cu/Al	#14-10	2.5-4.0	See Table 2-2
25-100		5/32" Hex	Cu/Al	#10-1/0	4.0-50	See Table 2-2
Use on GD - Steel Terminals						
15-100	Pressure (Steel Body)	Slotted	75°C Cu Only	#14-3	2.5-26.7	See Table 2-3
Use on GWF ①						
15-100	Pressure (Steel Body)	Slotted	Cu Only	#14-1	2.5-50	See Table 2-4

① Not UL Listed Sizes

② For line and load-side. Terminals are suitable for the wire type and size given

Table 2-4 GWF Terminal Torque Values

AWG Wire Range	Torque Value Lb-in	Torque Value N.m.
#14-1	45	5.08

Table 2-2 GD Terminal Torque Values

AWG Wire Range	Torque Value Lb-in	Torque Value N.m.
#14-10	20	2.26
#8	40	4.52
#6-4	45	5.08
#3-1/0	45	5.08

Table 2-3 GD With Steel Terminals Torque Values (75°C CU Only)

AWG Wire Range	Torque Value Lb-in	Torque Value N.m.
#14-10	35	3.95
#8	40	4.52
#6-3	45	5.08

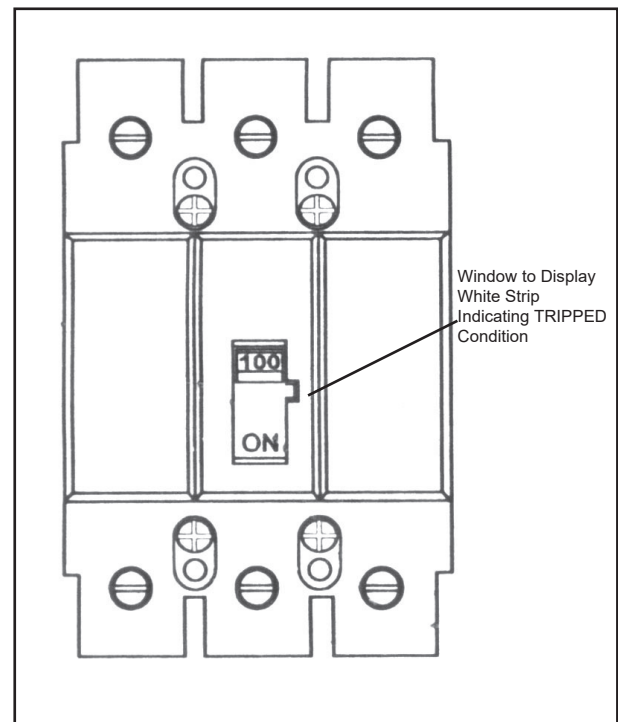

Figure 3-1 Circuit Breaker Manual Controls

2-5 After the circuit breaker is installed, check all mounting hardware and terminal connecting hardware for correct torque loading. Torque values for line/load terminals are given in Tables **2-1**, **2-2**, **2-3** and **2-4** and on the circuit breaker nameplate.

3. Manual Operation

Manual operation of the circuit breaker is controlled by the circuit breaker handle. There are two positions shown on the handle to indicate when the circuit breaker is ON or OFF, also the tripped position is shown by a white strip. (See Figure **3-1**).

Circuit Breaker Reset

After an automatic trip operation, the circuit breaker is reset by moving the circuit breaker handle to the OFF position.

Note: In the event of a thermal trip, the circuit breaker cannot be reset until the thermal element cools.

4. Inspection and Field Testing

Molded case circuit breakers are designed to provide years of almost maintenance-free operation. The following procedure describes how to inspect and test a circuit breaker in service.

Inspection

Circuit breakers in service should be inspected periodically. The inspection should include the following checks.



WARNING

BEFORE INSPECTING THE CIRCUIT BREAKER IN AN ELECTRICAL SYSTEM, MAKE SURE THE CIRCUIT BREAKER IS SWITCHED TO THE OFF POSITION AND THAT THERE IS NO VOLTAGE PRESENT WHERE WORK IS TO BE PERFORMED. SPECIAL ATTENTION SHOULD BE PAID TO REVERSE FEED APPLICATIONS TO ENSURE NO VOLTAGE IS PRESENT. THE VOLTAGES IN ENERGIZED EQUIPMENT CAN CAUSE SEVERE PERSONAL INJURY OR DEATH.



CAUTION

MAKE SURE THAT CLEANING AGENTS OR SOLVENTS USED TO CLEAN THE CIRCUIT BREAKER ARE SUITABLE FOR THE JOB. SOME COMMERCIAL CLEANING AGENTS WILL DAMAGE THE NAMEPLATES OR MOLDED PARTS.

4-1 Remove dust, dirt, soot, grease, or moisture from the surface of the circuit breaker using a lint-free dry cloth, brush, or vacuum cleaner. Do not blow debris into circuit breaker. If contamination is found, look for the source and eliminate the problem.

4-2 Switch circuit to ON and OFF several times to be sure that the mechanical linkages are free and do not bind. If mechanical linkages are not free and are binding, replace circuit breaker.

4-3 Check base, cover, and operating handle for cracks, chipping, and discoloration. Circuit breakers should be replaced if cracks or severe discoloration is found.

4-4 Check terminals and connectors for looseness or signs of overheating. Overheating will show as discoloration, melting, or blistering of conductor insulation, or as pitting or melting of conductor surfaces due to arcing. If there is no evidence of overheating or looseness, do not disturb or tighten the connections. If there is evidence of overheating, terminations should be cleaned or replaced. Before reenergizing the circuit breaker, all terminations and cable should be refurbished to the condition when originally installed.

4-5 Check circuit breaker mounting hardware, tighten if necessary.

4-6 Check area where circuit breaker is installed for any safety hazards, including personal safety and fire hazards. Exposure to certain types of chemicals can cause deterioration of electrical connections.

Field Testing

Any field testing should be done in accordance with NEMA Standards Publication AB4-Latest Version.

NOTES:

NOTES:

The instructions for installation, testing, maintenance, or repair herein are provided for the use of the product in general commercial applications and may not be appropriate for use in nuclear applications. Additional instructions may be available upon specific request to replace, amend, or supplement these instructions to qualify them for use with the product in safety-related applications in a nuclear facility.

The information, recommendations, descriptions, and safety notations in this document are based on Eaton's experience and judgment with respect to Retrofitting of Power Breakers. This instructional literature is published solely for information purposes and should not be considered all-inclusive. If further information is required, you should consult an authorized Eaton sales representative.

The sale of the product shown in this literature is subject to the terms and conditions outlined in appropriate Eaton selling policies or other contractual agreement between the parties. This literature is not intended to and does not enlarge or add to any such contract. The sole source governing the rights and remedies of any purchaser of this equipment is the contract between the purchaser and Eaton.

NO WARRANTIES, EXPRESSED OR IMPLIED, INCLUDING WARRANTIES OF FITNESS FOR A PARTICULAR PURPOSE OR MERCHANTABILITY, OR WARRANTIES ARISING FROM COURSE OF DEALING OR USAGE OF TRADE, ARE MADE REGARDING THE INFORMATION, RECOMMENDATIONS, AND DESCRIPTIONS CONTAINED HEREIN. In no event will Eaton be responsible to the purchaser or user in contract, in tort (including negligence), strict liability or otherwise for any special, indirect, incidental or consequential damage or loss whatsoever, including but not limited to damage or loss of use of equipment, plant or power system, cost of capital, loss of power, additional expenses in the use of existing power facilities, or claims against the purchaser or user by its customers resulting from the use of the information, recommendations and description contained herein.

Eaton
Electrical Sector
1000 Eaton Boulevard
Cleveland, OH 44122
United States
877-ETN-CARE (877-386-2273)
Eaton.com

© 2016 Eaton
All Rights Reserved
Printed in USA
Publication No. IL 29C102G / TBG000478
Part No. 8790C98H07
June 2016