

# KwikSplice™ cable tray system Tab and lock trapeze support

### Features & Benefits

- Designed for KwikSplice cable tray system
- Rated for maximum load of KwikSplice cable tray system
- Accepts up to 3/8" rod
- Tabs clamp cable tray to trapeze support
- Accepts traditional hold down clamps (9ZN-1204) if necessary
- Pre-galvanized steel

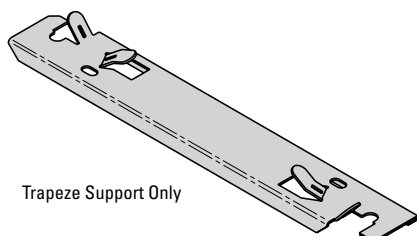

Trapeze Support Only

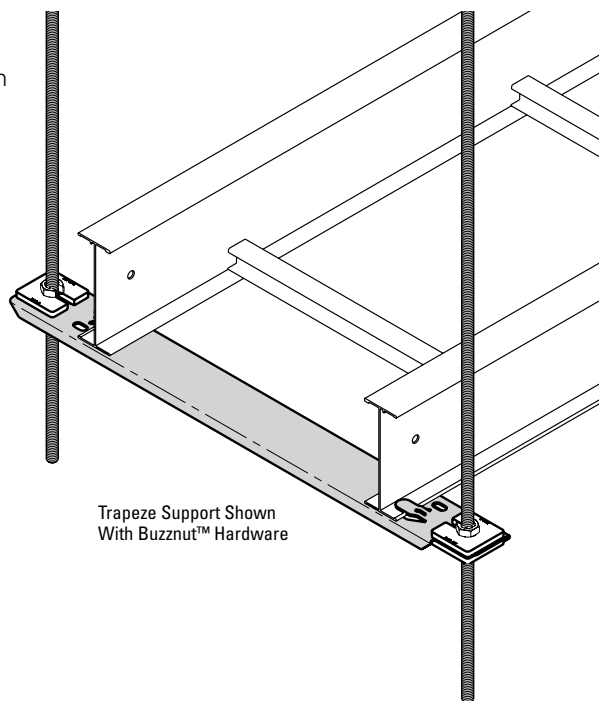

Trapeze Support Shown With Buzznut™ Hardware

Catalog #	Tray Width	
	in	mm
KSA-6CT	6"	152
KSA-9CT	9"	229
KSA-12CT	12"	305
KSA-18CT	18"	457
KSA-24CT	24"	610
KSA-30CT	30"	762
KSA-36CT	36"	914

Catalog #	Qty.	Hardware
B201	4	Standard
3/8" HN	4	Standard

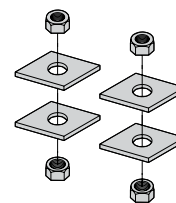

Standard Hardware

- OR -

Catalog #	Qty.	Hardware
SLWN3/8	4	Buzznut

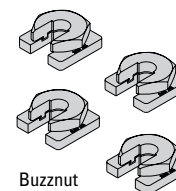

Buzznut Hardware

# Installation

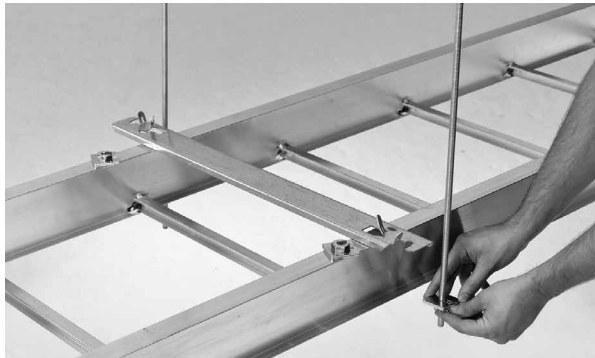

- 1** Install hardware on threaded rod to desired position.

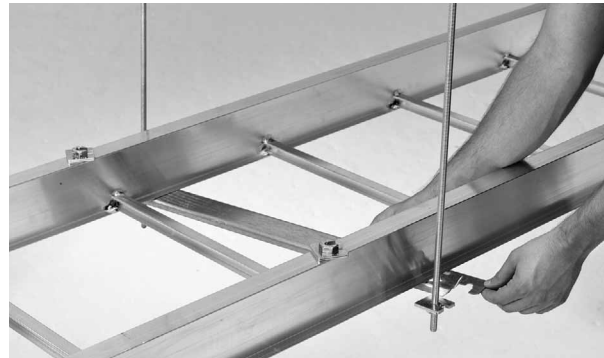

- 2** Insert flat head screwdriver into tab slots and open tabs to accept threaded rod and cable tray.

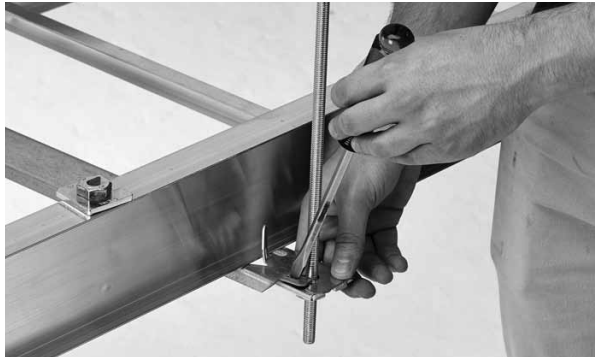

- 3** Position trapeze onto threaded rod and close tabs using the flat head screwdriver.



- 4** Once cable tray is positioned properly, close remaining tabs to clamp the cable tray to the trapeze support.



- 5** Install top threaded rod hardware locking the trapeze tabs into position.

**Eaton**  
1000 Eaton Boulevard  
Cleveland, OH 44122  
United States  
Eaton.com

© 2014 Eaton  
All Rights Reserved  
Printed in USA  
Publication No. CTIS-19  
September 2014

Eaton's B-Line Business  
509 West Monroe Street  
Highland, IL 62249  
United States  
Phone: 800-851-7415

[www.cooperbline.com/contactus](http://www.cooperbline.com/contactus)

Eaton is a registered trademark.

All other trademarks are property of their respective owners.