

PART NUMBER	SIZE	"A"	"B"	"C"	"D"	"E"	"F"
5133310	1/2	2 13/16"	4 9/16"	2 5/8"	2 15/16"	3 1/2"	7/8"
5133311	3/4	2 13/16"	4 9/16"	2 5/8"	2 15/16"	3 1/2"	1 1/16"
5133312	1	2 13/16"	4 9/16"	2 5/8"	2 15/16"	3 1/2"	1 5/16"

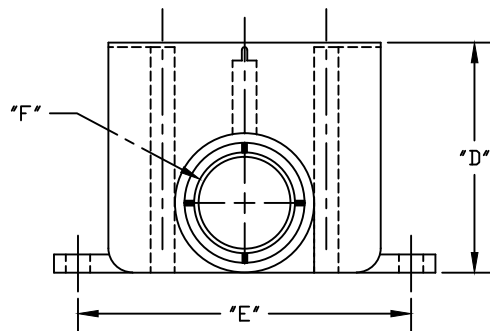

UL Listed
 UL File number E543001
 Material Is Rigid PVC
 CSA Listed

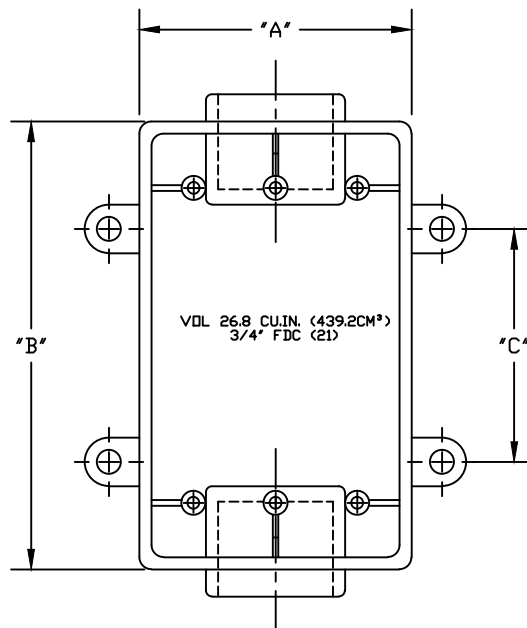
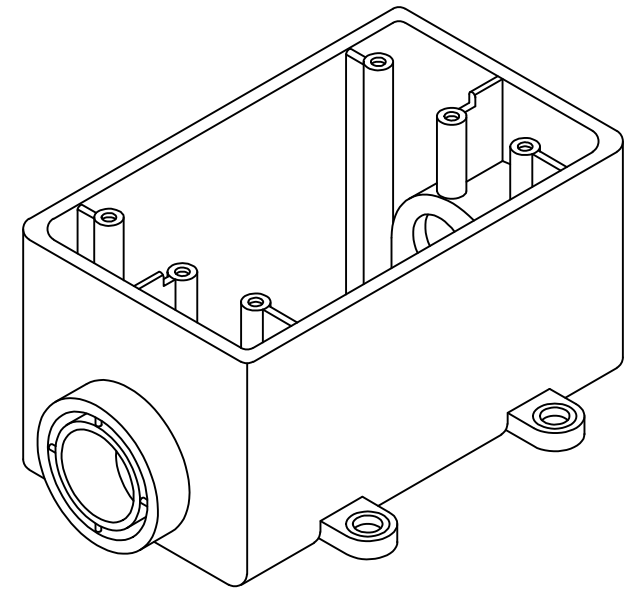

CANTEX INC. Fort Worth, TEXAS		
Type FDC Exposed Boxes		
Drawn By: O.M.	Date: 12/11/17	Ref. 5133310