

PART NUMBER	SIZE	"A"	"B"	"C"	"D"	"E"	Volume cu. in.	Maximum 3-wire Fill
5133101	1/2	1 5/16"	1 1/2"	4 5/8"	4"	7/8"	4.3	#6
5133102	3/4	1 1/2"	1 11/16"	5 3/8"	4 5/8"	1 1/16"	6.5	#6
5133103	1	1 3/4"	2"	6 9/16"	5 3/8"	1 5/16"	11.8	#6
5133104	1-1/4	2 1/2"	2 1/2"	8 3/16"	7 3/16"	1 1/16"	25	XHHW #1
5133105	1-1/2	2 5/8"	2 13/16"	9 1/4"	8"	1 15/16"	36.5	XHHW#2/0
5133106	2	3 1/8"	3 3/8"	10 3/8"	9 1/2"	2 3/8"	63.5	XHHW#4/0
5133108	2-1/2	N/A	N/A	N/A	N/A	N/A	198	XHHW 500MCM
5133107	3	4 5/8"	4 5/8"	1' 7"	1' 7/8"	3 1/2"	198	XHHW 500MCM
5133110	3-1/2	5 9/16"	5 9/16"	1' 8 3/8"	1' 1 3/4"	4"	305	XHHW 500MCM
5133109	4	5 9/16"	5 9/16"	1' 8 3/16"	1' 1 7/8"	4 1/2"	305	XHHW 500MCM

Dimensions are nominal

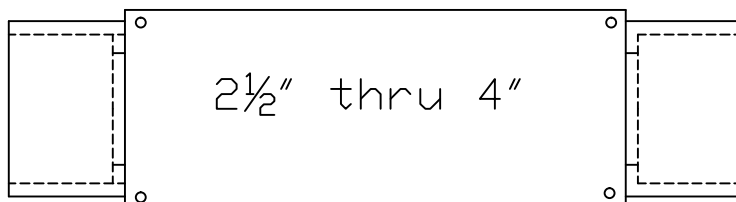

UL Listed
 UL File # E98429
 UL Category Code QCMZ
 UL Control Number 39N9
 Material is Rigid PVC
 Gasket is Neoprene
 Zinc plated steel screws
 See NEC Article 314 for use

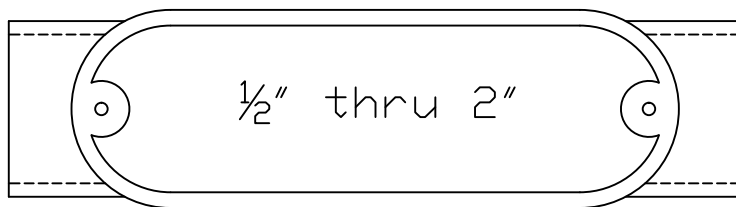
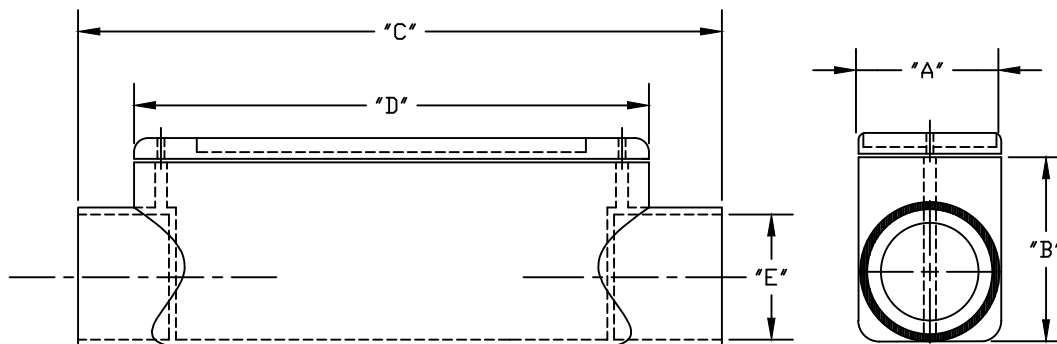

CANTEX INC. Fort Worth, TEXAS		
Type C Conduit Bodies		
Drawn By: O.M.	Date: 5/15/17	Ref. 5133101