

Solar Power Product Solutions

SOLUTIONS GUIDE

Comprehensive photovoltaic protection



MERSEN

SOLAR POWER MERSEN KEEPS IT SAFE & RELIABLE

A global leader with a century of experience, Mersen brings expertise and innovation to your company



Protect your solar power investment by using electrical components specifically designed for PV applications

Generating electricity from solar energy is an extremely reliable process – as long as it's properly protected! Mersen offers a trusted range of electrical protection solutions that help protect your solar power investment including fuses, fuseholders, heatsinks, wire management, disconnect switches, laminated bus bar, and surge protective devices.

With a dedicated range of products to disconnect, clip and isolate, Mersen is doing whatever it takes to shield the wiring between strings and protect system components. Thanks to our newly developed, innovative HelioProtection® product line, faulty circuits are safely isolated and system longevity and reliability are increased allowing for continuous generation of clean and efficient power.

Drawing on over a century of experience – and an ongoing commitment to critical research in electrical safety in both traditional and emerging markets – Mersen provides solar power designers, integrators, specifying engineering firms, solar power installers and solar power equipment manufacturers with innovative electrical protection products and unmatched technical support. For solar power circuit protection solutions you can rely on, contact Mersen at info.nby@mersen.com or 978.462.6662.



About Mersen's HelioProtection® Brand

The word helio, meaning sun, was derived from Greek mythology and the sun god, Helios. When combined with the safety and reliability of Mersen's electrical protection solutions, HelioProtection defines our commitment to the solar industry. Mersen's HelioProtection brand promises expertise in solar power applications and a premium offering designed for the PV industry.

Products marked with the HelioProtection brand name have been tested and certified to the latest industry standards for use in photovoltaic applications and guarantee the level of performance required by the PV industry. Not only is Mersen the industry benchmark when it comes to standards compliance, we voluntarily subject our products to strict quality monitoring backed by extensive electrical, mechanical and climatic tests.

Mersen is the PV Industry Benchmark

- 1st to market with UL 2579 Listed product
- Helped drive the new safety standard
- The only manufacturer serving the PV market with overcurrent, surge protection, laminated bus bar, and cooling solutions



HelioProtection® Brand Promise

- Expertise in solar power applications
- Premium offering for the PV industry
- Delivering safety & reliability

Photovoltaic Fuses



Photovoltaic Fuseholders



Surge Protective Devices



PV Safety Solutions



Power Electronics Solutions

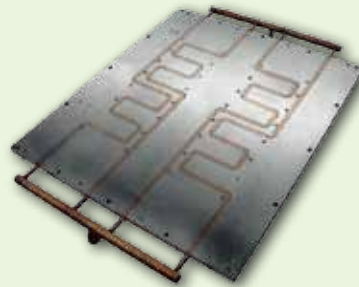

Wire Management



Table of Contents – Product Solutions

HelioProtection® Photovoltaic String Fuses

HP6M 600VDC ferrule 10x38mm for string protection.....	6
HP10M 1000VDC ferrule 10x38mm for string protection.....	6
NEW HP15M 1500VDC ferrule 10x85mm for string protection.....	6

HelioProtection Photovoltaic Array Fuses

HP6J 600VDC class J for array / inverter protection	7
NEW HP10J 1000VDC class J for array / inverter protection	8
NEW HP10NH 1000VDC size NH for array / inverter protection	9
NEW HP12NH 1250VDC size NH for array / inverter protection	10
NEW HP15NH 1500VDC size NH for array / inverter protection	11

Photovoltaic Fuseholders and Blocks

UltraSafe™ fuseholders for string combiner box applications.....	12
GPM panel mount fuseholder for small inverter applications.....	13
FEB In-line fuseholder for string cable harness applications	13
HPJ blocks for use with class J fuses in array / inverter applications.....	14
NEW HPBB blocks for use with size NH fuses in array / inverter applications	15

Surge-Trap® Surge Protective Devices

ST modular design suitable for all PV applications	16
NEW STP pluggable design suitable for all PV applications	16

Wire Management Solutions

FSPDB finger-safe power distribution blocks for string combiner box applications.....	17
NEW MPDB open-style power distribution blocks for string combiner box applications.....	17

Disconnect Switches

NEW Load break switch for combiner and re-combiner box applications	18
DC Contactors for inverter applications.....	19

Electronic Systems for Energy Management

NEW PV string monitoring cards for combiner box applications	20
NEW Safety system for PV installation	21

Power Electronics Solutions

Cooling devices for inverter applications.....	22
Laminated bus bar for inverter applications	23

Codes & Standards for PV Applications



National Electrical Code® (NEC)

- **1 to 3 strings of modules: no fuse needed:** In this kind of system, the fault current is barely higher than operating current. Properly sizing the wiring between the strings of panels to withstand the maximum fault current is enough to avoid any fire hazard.
- **Installation with at least 4 strings of modules:** In this configuration the fault current can reach a level capable of heating and damaging the insulators. For this type of installation, ungrounded systems must be fused for both polarities, positive and negative, grounded systems only require fusing of the positive conductors.
- **Sizing Fuses per the National Electrical Code (Article 690.8):** As defined in Article 690.8, two multiplication factors must be applied when sizing overcurrent devices for photovoltaic application, the maximum PV source circuit current and the overcurrent device loading factor. The maximum photovoltaic source circuit current is equal to the module rated short circuit current (I_{sc}) multiplied by 125 percent. When determining the sizing of overcurrent device ampacity, the device shall be sized to carry not less than 125 percent the maximum current. Module I_{sc} ratings are required by code to be listed on the PV module nameplate. Typical I_{sc} ratings are 110-125% of the maximum power point current (I_{mpp}) value of the PV module.

$$\text{Nominal Fuse Rating} = I_{sc} \text{ (Module Short Circuit Current)} \times 1.25 \text{ (Max Current Multiplier)} \times 1.25 \text{ (Overcurrent Device Sizing Multiplier)}$$

↓

$$\text{Nominal Fuse Rating} = I_{sc} \times 1.56$$

If the calculated nominal fuse rating value is not available it is allowed to go to the next highest available fuse current rating.

Canadian Electrical Code (CEC)

Section 50 of the Canadian Electrical Code outlines the requirements for solar photovoltaic systems. Within Section 50 there are references to Section 14; specifically, to Rules 14-414 Connection to different circuits; 14-700 Restriction of use; 14-200, Fuses; and 14-300, Circuit Breakers. Within Section 50, Rule 50-020 also refers to Section 84, Interconnection of electric power production sources, where the grounding and bonding requirements may be found. Ultimately, NEC Article 690 should be used when determining requirements for PV systems (while supplementing with information from CEC Section 50 for Canadian applications).

Underwriters Laboratories (UL)

UL 2579 – Fuses for Photovoltaic Systems is a product standard written specifically for fuses intended to be used for photovoltaic circuit protection. Unlike UL standard 248, “Low Voltage Fuses”, fuses listed to UL standard 2579 are subject to additional testing, simulating the service environment conditions of photovoltaic installations. Additional testing includes, (1) Verification of Freedom from Unacceptable Levels of Thermally Induced Drift, (2) Verification of Functionality at Temperature Extremes and (3) Current Cycling. For more information regarding UL standard 2579 visit Mersen at ep-us.mersen.com > Resources > Articles and White Papers.

UL 4248-18 – Photovoltaic Fuseholders applies to fuseholders rated up to 1500VDC, intended for use with Photovoltaic Fuses as described in the Outline of Investigation for Fuses for Photovoltaic Systems, Subject 2579.

UL 98B – Enclosed and Dead-Front Switches for use in Photovoltaic Systems covers enclosed and dead-front switches rated up to 1000VDC, intended for use in DC photovoltaic (PV) systems and installed in accordance with Article 690 of the National Electrical Code.

International Electrotechnical Commission (IEC)

IEC 60269-6 – Fuse-links for the Protection of Photovoltaic Energy Systems: IEC standard 60269-6, “Fuse-links for the Protection of Photovoltaic Energy Systems,” defines supplemental requirements applied to fuse-links for protecting PV strings and PV arrays in equipment for circuits of nominal voltages up to 1500VDC. Fuses complying with IEC standard 60269-6 shall be marked “gPV” indicating fuse-links with a full-range DC breaking capacity for photovoltaic energy systems.



Products By Application

Electrical protection components for solar power

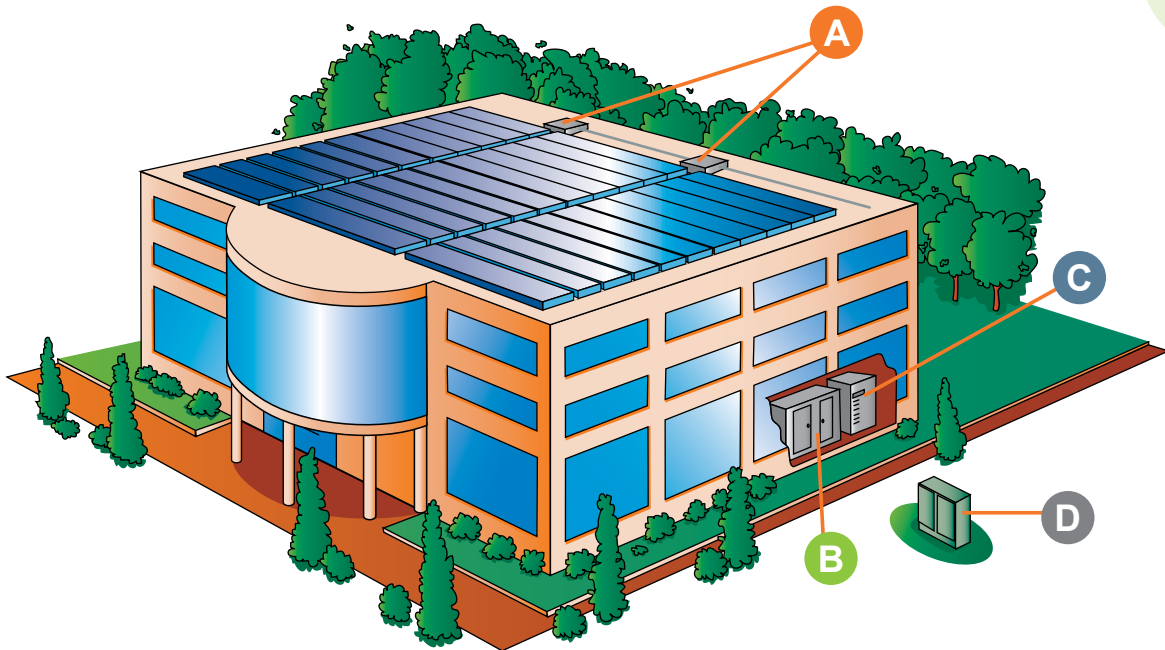

A

String Combiner Box / Array Combiner Box

Fuses & fuseholders • Surge protection devices
Disconnect switches • Power distribution blocks
Monitoring • PV Safety System

B

Inverter

Fuses & fuseholders • Surge protection devices
Disconnect switches • Power distribution blocks
Thermal management • Contactors • Laminated bus bar

C

AC Electrical Panelboard

Fuses & fuseholders • Surge protective devices
Disconnect switches

D

Utility Distribution Network

Fuses • Cable limiters

Residential 5 to 36kW

Mersen is a trusted partner of electrical equipment distributors and played a leadership role in solar power circuit protection long before the boom reached the residential market, i.e. for private homes, small apartment buildings and farm buildings.



Commercial and Industrial 36 to 250kW

The walls and roofs of buildings - office towers, factories, malls and warehouses - are among the preferred supports for solar power systems. Architects and developers have grasped the importance of this energy revolution, and more of them are recommending "green" solutions.

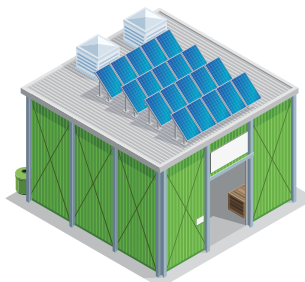

Utility and Solar Farm Over 250kW

In this type of application, the architecture is centered on an automatic monitoring and control system. Mersen caters to this critical market with electrical protection that safely & reliably protects the solar power investment.



Photovoltaic Fuses

HP6M (600VDC), HP10M (1000VDC), and HP15M (1500VDC) series for string protection

Enhanced Construction For Demanding PV Applications

Mersen's HeliProtection® HP6M and HP10M photovoltaic (PV) fuse series was engineered and designed specifically for the protection of photovoltaic strings. Its enhanced fuse construction is designed to withstand constant fluctuations in temperature and current cycling adding to system longevity. Low minimum breaking capacity of 1.35 times the fuse rated current value meets both IEC and UL standards, allowing for safe circuit interruption under typical low fault current conditions produced by PV strings. Typical applications include string combiner boxes and in-line fuse assemblies.



Catalog Numbers and Electrical Characteristics

Voltage (VDC)	Amperage (A)	Catalog Number	Reference Number	Watts Loss @ 70% x In (W)	Watts Loss @ 80% x In (W)	Watts Loss @ 100% x In (W)	Interrupting Rating (kA)	Size (mm)
600	1	HP6M1	L1018565	0.14	0.19	0.31	10	10x38
	2	HP6M2	M1018566	0.19	0.26	0.43		
	3	HP6M3	N1018567	0.64	0.85	1.4		
	4	HP6M4	Q1018569	0.58	0.77	1.3		
	5	HP6M5	R1018570	0.65	0.87	1.4		
	6	HP6M6	S1018571	0.69	0.92	1.5		
	7	HP6M7	T1018572	-	-	-		
	8	HP6M8	V1018573	0.92	1.23	2.0		
	10	HP6M10	X1018575	0.96	1.28	2.1		
	12	HP6M12	Y1018576	1.12	1.49	2.5		
	15	HP6M15	Z1018577	0.99	1.32	2.2		
	20	HP6M20	A1018578	1.25	1.67	2.8		
	25	HP6M25	K1018610	1.38	1.84	3.1		
30	HP6M30	L1018611	1.50	2.00	3.3			
1000	1	HP10M1	B1018579	0.125	0.175	0.25	10	10x38
	2	HP10M2	C1018580	0.16	0.25	0.32		
	3	HP10M3	D1018581	0.66	0.87	1.36		
	3.5	HP10M3-1/2	H1043977	-	-	-		
	4	HP10M4	E1018582	0.69	0.80	1.25		
	5	HP10M5	F1018583	0.59	0.73	1.12		
	6	HP10M6	G1018584	0.42	0.67	1.05		
	7	HP10M7	H1018585	0.40	0.64	1.00		
	8	HP10M8	J1018586	0.77	0.88	1.48		
	10	HP10M10	L1018588	0.67	0.9	1.5		
	12	HP10M12	M1018589	0.72	1.0	1.8		
	15	HP10M15	N1018590	0.9	1.3	2.2		
	20	HP10M20	P1018591	1.1	1.5	2.8		
	25	HP10M25	D1023825	1.3	1.8	3.0		
	30	HP10M30	E1023826	1.5	1.9	3.7		
1500	12	HP15MGPV12	-	1.5		3.7		10x85
	16	HP15MGPV16	-	2.3		5.7		

Catalog Numbers - Fuseholder

Voltage (VDC)	Amperage (A)	Terminal Type	Visual Blown Fuse Indicator	Catalog Number
1000	32	Screw	No	USM1HEL
			Yes	USM1IHEL
1000	32	Spring	No	USGM1HEL
			Yes	USGM1IHEL

Approvals

- UL Listed to 2579, photovoltaic fuse, File E333668 (10x38 only)
- CSA Component Acceptance, Class 1422-30
- IEC 60269-6 Certified, gPV
- RoHs Compliant



For additional information about fuseholders for HP6M and HP10M see page 12. Fuse clips for HP10M (MR10RESSORTCI) are also available. For additional information about HP6M, HP10M, and HP15M photovoltaic fuses visit ep.mersen.com

Photovoltaic Fuses

HP6J (600VDC) series for array protection



Protect Your Off-grid or Grid-tied PV Systems

The HelioProtection® HP6J photovoltaic (PV) fuse series was engineered and designed specifically for the protection of photovoltaic arrays. Its enhanced fuse construction is designed to withstand constant fluctuations in temperature and current cycling adding to system longevity. Low minimum breaking capacity of 1.35 times the fuse rated current value meets UL standards, allowing for safe circuit interruption under typical low fault current conditions produced by PV arrays. Typical applications include re-combiner box, master combiner box and inverter inputs.

Catalog Numbers and Electrical Characteristics

Voltage (VDC)	Amperage (A)	Catalog Number	Reference Number	Watts Loss @ 80% x In (W)	Watts Loss @ 100% x In (W)	Interrupting Rating (kA)	Size
600	70	HP6J70	K1023394	5.8	10	10	Class J
	80	HP6J80	L1023395	6.4	11		
	90	HP6J90	M1023396	7.5	13		
	100	HP6J100	N1023397	8.1	14		
	110	HP6J110	P1023398	10.4	18		
	125	HP6J125	Q1023399	11.0	19		
	150	HP6J150	R1023400	12.8	22		
	175	HP6J175	S1023401	13.9	24		
	200	HP6J200	T1023402	15.1	26		
	225	HP6J225	V1023403	17.4	30		
	250	HP6J250	W1023404	20.9	36		
	300	HP6J300	X1023405	22.0	38		
	350	HP6J350	V1023380	23.2	40		
	400	HP6J400	Y1023406	24.4	42		
	450	HP6J450	V1026278	33.6	58		
500	HP6J500	W1026279	34.2	59			
600	HP6J600	X1026280	39.4	68			

Dimensions

Ampere Rating	A		B		C		D		E		F		G		H	
	in	mm	in	mm	in	mm	in	mm	in	mm	in	mm	in	mm	in	mm
HP6J (61-100)	4-5/8	117	1-1/16	27	1/8	3.2	3/4	19	1	25	3-5/8	92	3/8	10	9/32	7
HP10J (61-200) HP6J (101-200)	5-3/4	146	1-5/8	41	3/16	4.8	1-1/8	29	1-3/8	35	4-3/8	111	3/8*	10*	9/32*	7*
HP6J, HP10J (201-400)	7-1/8	181	2-1/8	54	1/4	6.3	1-5/8	41	1-7/8	48	5-1/4	133	17/32	14	13/32	10
HP6J (401-600)	8	203	2-1/2	64	3/8	9.5	2	51	2-1/8	54	6	152	11/16	18	17/32	13

* For HP10J, G = 17/32" (14mm) and H = 13/32" (10mm)

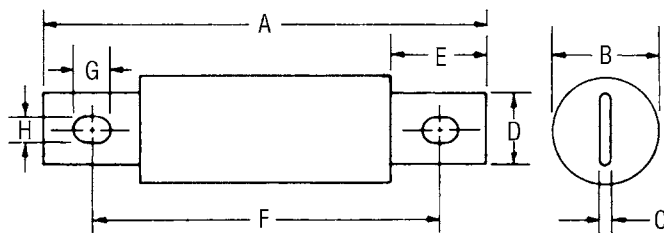

Catalog Numbers – Fuse Blocks

For recommended fuse blocks for HP6J and HP10J fuses see page 9.

Approvals

- UL Listed to 2579, photovoltaic fuse, File E333668
- CSA Component Acceptance, Class 1422-30
- RoHS Compliant

For additional information about HP6J photovoltaic fuses visit ep.mersen.com



Photovoltaic Fuses

HP10J (1000VDC) series for array protection

The industry's most efficient 1000VDC fuses

The HeliProtection® HP10J photovoltaic (PV) fuse series was engineered and designed specifically for the protection of photovoltaic arrays. Its enhanced fuse construction is designed to withstand constant fluctuations in temperature and current cycling adding to system longevity. Low minimum breaking capacity of 1.35 times the fuse rated current value meets UL standards, allowing for safe circuit interruption under typical low fault current conditions produced by PV arrays. Typical applications include re-combiner box, master combiner box and inverter inputs.



Catalog Numbers and Electrical Characteristics

Voltage (VDC)	Amperage (A)	Catalog Number	Reference Number	Watts Loss @ 80% x In (W)	Watts Loss @ 100% x In (W)	Interrupting Rating (kA)	Size	Frame Size
1000	70	HP10J70	Z1040749	5	10	10	Class J	1
	80	HP10J80	A1040750	5	10			
	100	HP10J100	B1040751	7	15			
	125	HP10J125	C1040752	7	14			
	160	HP10J160	D1040753	8	16			
	200	HP10J200	E1040754	15	27			
	250	HP10J250	F1040755	18	34			2
	300	HP10J300	G1040756	22	37			
	350	HP10J350	H1040757	24	45			
	400	HP10J400	J1040758	27	52			
	450	HP10J450	K1040759	27	56			
	500	HP10J500	K1047107	31	58			
600	HP10J600	L1047108	43	82				

Dimensions

For dimensions for HP10J fuses see page 8

Optional Indicator/Microswitch Mount Dimensions

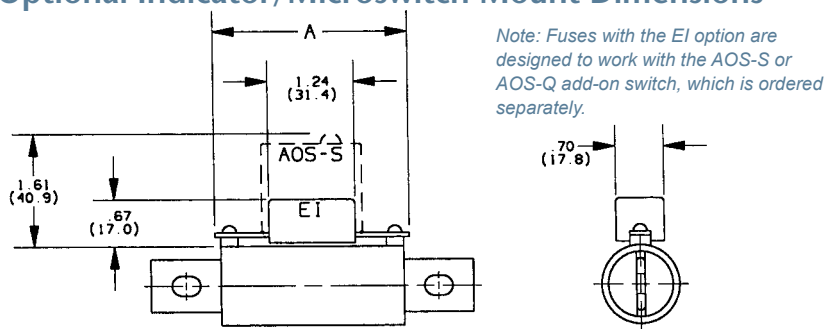

Catalog Number	A
HP10J(70-200)EI	3.22 (81.8)
HP10J(250-400)EI	3.24 (82.2)

Catalog Numbers – Fuse Blocks

Voltage (VDC)	Amperage (A)	Terminal Type	Wire Range	Catalog Number
1000	HP6J (61-100)	Box-Box	2/0 - #6	61036HPJ
	HP10J (61-200)	Box-Box	350kcmil - #6	62001HPJ
	HP6J (101-200)	Box-Box	(2) 350kcmil - #6	64031HPJ
	HP6J, HP10J (201-400)	Box-Box	(2) 500kcmil - #4	6631HPJ
	HP6J (401-600)	Box-Box	(2) 500kcmil - #4	6631HPJ

For additional information about fuse blocks for HP6J and HP10J see page 14

For additional information about HP10J photovoltaic fuses visit ep.mersen.com

Approvals

- UL Listed to 2579, photovoltaic fuse, File E333668
- CSA Component Acceptance, Class 1422-30
- RoHS Compliant



Photovoltaic Fuses

HP10NH (1000VDC) series for array protection

About the HP10NH Fuse

The HelioProtection® HP10NH photovoltaic (PV) fuse series was engineered and designed specifically for the protection of photovoltaic arrays. Its enhanced fuse construction is designed to withstand constant fluctuations in temperature and current cycling adding to system longevity. Low minimum breaking capacity of 1.35 times the fuse rated current value meets IEC and UL standards, allowing for safe circuit interruption under typical low fault current conditions produced by PV arrays. Typical applications include re-combiner box, master combiner box and inverter inputs.



Catalog Numbers and Electrical Characteristics

Voltage (VDC)	Amperage (A)	Catalog Number	Reference Number	Watts Loss @ 70% x In (W)	Watts Loss @ 100% x In (W)	Interrupting Rating (kA)	Size
1000	50	HP10NH1GPV50	Z1028283	4.6	11	50	NH1
	63	HP10NH1GPV63	A1028284	5.4	13		
	80	HP10NH1GPV80	B1028285	6.1	15		
	100	HP10NH1GPV100	C1028286	7.2	17		
	125	HP10NH1GPV125	D1028287	7.4	18		
	160	HP10NH1GPV160	E1028288	9.6	23		
1000	200	HP10NH2GPV200	X1037619	12.0	29	50	NH2
	250	HP10NH2GPV250	Y1037620	14.0	34		

Dimensions (mm)

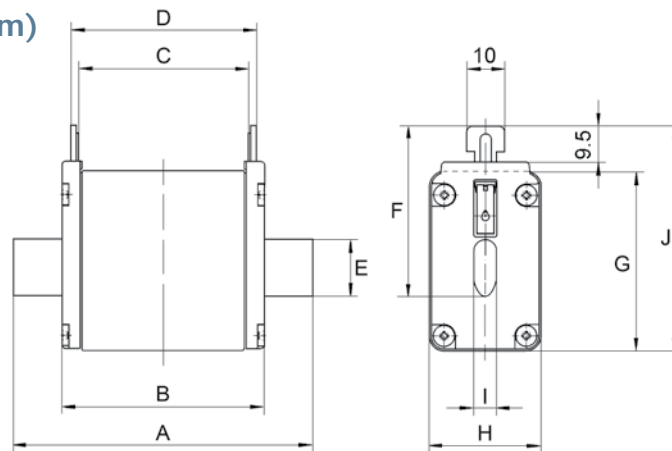

Size	A	B	C	D	E	F	G	H	I	J
NH1	135	70.8	63	68	20	40	52.5	39.5	6	64.5
NH2	150	68	63	68	26	48.5	60	51	6	72

Catalog Numbers – Fuse Blocks

For use with	Voltage (VDC)	Amperage (A)	Terminal Type	Protective Cover	Catalog Number
NH1	1000	250 max	Stud-Stud	No	HPBB11PPR
				Yes	HPBB11PPRFS
NH2	1000	315 max	Stud-Stud	No	HPBB21PPR
				Yes	HPBB21PPRFS

For additional information about fuse blocks for HP10NH see page 15

Approvals:

- UL Listed to 2579, photovoltaic fuse, File E358319
- IEC 60269-6 Certified, gPV
- RoHS Compliant



For additional information about HP10NH photovoltaic fuses visit ep.mersen.com

Photovoltaic Fuses

HP12NH (1250VDC) series for array protection

About the HP12NH Fuse

Mersen's HP12NH photovoltaic (PV) fuse series was engineered and designed specifically for the protection of photovoltaic systems. Helio-Protection® HP12NH fuse links are designed for the protection of cables in a PV group of chains when a short circuit occurs in a panel (main fuse category). This HelioProtection main fuse range enlarges our PV fuse links offering on a size having a worldwide acceptance. They are of the gPV type and comply with both IEC 60269-6 and UL 2579 PV standards.



Catalog Numbers and Electrical Characteristics

Voltage (VDC)	Amperage (A)	Catalog Number	Reference Number	Watts Loss @ 70% x In (W)	Watts Loss @ 100% x In (W)	Interrupting Rating (kA)	Size
1250	125	HP12NH1XLGPV125	G1039744	11.5	29		NH1
1250	160	HP12NH1XLGPV160	H1039745	14.5	36		NH1
1250	200	HP12NH2XLGPV200	J1039746	16	40		NH2
1250	250	HP12NH2XLGPV250	K1039747	18	44		NH2
1250	250	HP12NH3LGPV250	Z1033389	18	46		NH3
1250	315	HP12NH3LGPV315	A1033390	22	53		NH3
1250	350	HP12NH3LGPV350	B1033391	23	55		NH3
1250	400	HP12BH3LGPV400	C1033392	29	73		NH3

Dimensions (mm)

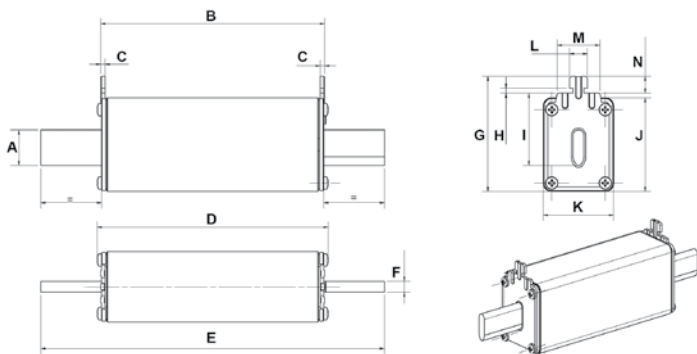

Approvals:

- UL Listed to 2579, photovoltaic fuse, File E358319
- IEC 60269-6 Certified, gPV
- RoHS Compliant



Size	A	B	C	D	E	F	G	H	I	J	K	L	M	N
NH1	20	125.5	2.5	129.6	192.5	6	64.5	2.75	40.5	52.5	39.5	10	24	9.5
NH2	26	123	2.5	127	205	6	72	2.75		60	51	10	24	9.5
NH3	33	123	2.5		127.8		84.5	2.75	60	74	70	10	25	9.5

Catalog Numbers – Open Fuse Bases and Fuse-Bases with Touch Protection

For use with	Voltage (VDC)	Amperage (A)	Design	Catalog Number
NH fuse-links NH1XL and gPV fuse-link size 121 with blade contacts	1500	250 A	Open design, screw mounting	SP36121
NH fuse-links NH2XL and NH3L and gPV fuse-link size 122-123 with blade contacts	1500	630 A	Open design, screw mounting	SP36122-123
NH fuse-links NH1XL (can accept Mersen gPV fuse-links size 121 and NH2XL rated 250A with derating)	1500	250 A	With touch protection, screw mounting (M10, M = 8-10Nm)	HPBB1XL1PPFS
NH fuse-links NH2XL and NH3L	1500	500 A	With touch protection, screw mounting (M10, M = 8-10Nm)	HPBB2XL3L1PPFS
NH fuse-links NH2XL and NH3L (can accept NH3L fuse-links up to 630 A with derating)	1500	500 A	With touch protection, screw mounting (M10, M = 8-10Nm) and busbar output (1x40x10 or 2x40x10)	HPBB2XL3L1PBFS

For additional information about HP12NH photovoltaic fuses visit ep.mersen.com

Photovoltaic Fuses

HP15NH (1500VDC) series for array protection

1500VDC for Future Trends and Higher Efficiencies

Mersen's HeliProtection HP15NH photovoltaic (PV) fuse series is designed specifically for protection of photovoltaic arrays. Low minimum breaking capacity of 1.35 times the fuse rated current value meets both IEC and UL (pending) standards, allowing for safe circuit interruption under typical low fault current conditions produced by PV arrays. Typical applications include re-combiner box, master combiner box and inverter inputs.



Catalog Numbers and Electrical Characteristics

Voltage (VDC)	Amperage (A)	Catalog Number	Reference Number	Watts Loss @ 70% x In (W)	Watts Loss @ 100% x In (W)	Interrupting Rating (kA)	Size
1500	160	HP15NH3LGPV160B	T1048679	15	35	50	NH3L
	200	HP15NH3LGPV200B	V1048680	17	40		
	250	HP15NH3LGPV250B	W1048681	19	45		
	315	HP15NH3LGPV315B	X1048682	21	52		
	350	HP15NH3LGPV350B	Y1048683	23	56		
	400	HP15NH3LGPV400B	Z1048684	24	59		

Dimensions

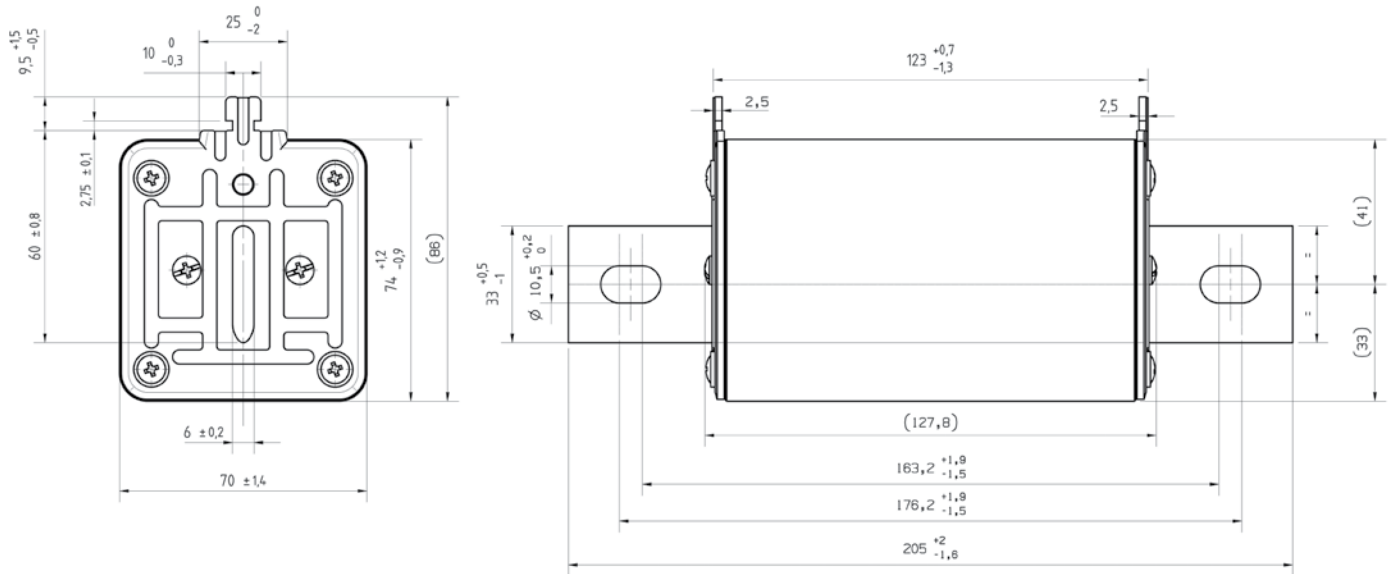

Catalog Numbers – Fuse Blocks

For use with	Voltage (VDC)	Amperage (A)	Terminal Type	Protective Cover	Catalog Number
NH3L	1500	500 max	Stud-Box	Yes	HPBB2XL3L1PBFS
			Stud-Stud	Yes	HPBB2XL3L1PPFS

For additional information about fuse blocks for HP15NH photovoltaic fuses see page 15

Approvals:

- UL listed to 2579
- IEC 60269-6 Certified, gPV
- RoHS Compliant



For additional information about HP15NH photovoltaic fuses visit ep.mersen.com

PV Fuseholders and Blocks

UltraSafe™ for string combiner box applications

A Tool-free and Touch-safe Design Increases User Safety

Mersen's line of UltraSafe fuseholders deliver the function, safety and level of circuit protection demanded by PV applications. Designed with enhanced materials and insulation properties providing the level of reliability and system longevity needed for high ambient conditions commonly seen at PV sites. The touch-safe design and tool-free fuse change-outs increase user safety. The unique spring terminal option is immune to vibration, corrosion and temperature making it the ideal choice for PV installation. Combine with Mersen's HeliProtection HP6M or HP10M fuses for industry leading PV circuit protection.



Catalog Numbers and Electrical Characteristics

For use with	Voltage (VDC)	Amperage (A)	Terminal Type	Visual Blown Fuse Indicator	Catalog Number	Reference Number
Midget (10x38mm)	1000	32 max	Screw	No	USM1HEL	L1028363
				Yes	USM1IHEL	M1028364
Midget (10x38mm)	1000	32 max	Spring*	No	USGM1HEL	P1022294
				Yes	USGM1IHEL	N1022293

Additional Specifications

Connector Type: Screw or CAGE CLAMP® spring

Suggested Screw Torque: 14.75 in-lbs

Wire Range : 14 to 6 AWG (2.5 to 16mm²) single conductor
: 14 to 10 AWG (2.5 to 5mm²) dual conductor

Wire Type: 60/75/90°C solid/stranded copper

Load Break Disconnect: No

Max Power Losses: 3W

Blown Fuse Indicator Operating Voltage: 350-1000VDC

Flammability: UL94V0

Recommended Fuse Usage: HP6M and HP10M

Approvals:

- UL Listed to 4248-18, File E347822
- CSA Component Acceptance, Class 6225-01
- IEC 60269-2-1 and 60947-3 Certified
- RoHS Compliant



*Mersen Spring Terminal Technology

Wire surrounded on all four sides



Wire retention spring reinforces high contact pressure

"S" bend provides defined contact area

Higher Reliability

- Immune to vibration, corrosion and temperature
- Maintenance-free, eliminates the need to re-torque
- Superior connection every time independent of operator skill

Increased Ease-of-Use

- No tools required for installation or maintenance

Lower Total System Cost

- Reduce installation time by 75%

Accessories – USBB series Comb Bus Bar (for use with screw type only)

Comb Bus Bar

Voltage (VDC)	Amperage (A)	Phase	Poles	Catalog Number	Cross Section	Pitch	Material
1000	100 (End Feed)	1	4	USBB1PH25K4	25mm ²	17.8mm	Copper
			6	USBB1PH25K6			
	200 (Center Feed)		8	USBB1PH25K8			
			12	USBB1PH25K12			

Power Feeder Terminal

Voltage (VDC)	Amperage (A)	Phase	Wire Range	Catalog Number
1000	115	1	10 - 1/0 AWG	USBBC1
			14 - 1 AWG	USBBSB1

For additional information about UltraSafe photovoltaic fuseholders visit ep.mersen.com

PV Fuseholders and Blocks

GPM Series panel mount fuseholders for inverter applications

Mersen GPM panel mount fuseholders accommodate midget class (10x38mm) HP6M and HP10M fuses. All 30A holders have glass-filled thermoplastic insulators for extra dependability and trouble-free installation. Patented design allows the same body to accept a screw or bayonet knob. Flange design allows for front or rear mounting.



Catalog Numbers & Descriptions

Catalog No.	Fig.	Cap Type	Amps	Volts	Fuse Type	Terminal Type
GPM-S	1	Screw Knob	30	600	1-1/2" x 13/32"	1/4" Quick-connect/Solder
GPM-S90	2	Screw Knob	30	600	1-1/2" x 13/32"	1/4" Quick-connect/Solder, Right Angle
GPM-B	1	1/4 Turn Bayonet Knob	30	600	1-1/2" x 13/32"	1/4" Quick-connect/Solder
GPM-B90	2	1/4 Turn Bayonet Knob	30	600	1-1/2" x 13/32"	1/4" Quick-connect/Solder, Right Angle
GPM-WT	1	Water-tight Screw Knob	30	600	1-1/2" x 13/32"	1/4" Quick-connect/Solder
GPM-WT90	2	Water-tight Screw Knob	30	600	1-1/2" x 13/32"	1/4" Quick-connect/Solder, Right Angle

Ratings:

Volts : 600VDC
 : 1000VDC Self-Certified
Amps : 30A Maximum
SCCR : 100kA

Approvals:

- UL Recognized to 4248, File E52283
- CSA Certified, class 6225-01



FEB Series in-line fuseholders for string cable harness applications

Mersen's line of single pole in-line fuseholders accommodate (10x38mm) midget HP6M and HP10M fuses. The fuseholders are designed for quick installation. Three internal O-rings per pole seal the fuseholder providing a water-resistant compartment for the fuse. The captive O-rings are colored blue for quick detection.

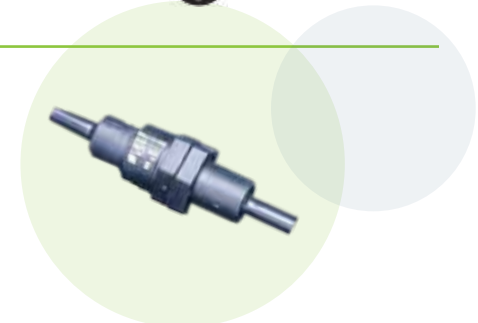

Catalog Numbers

FEB-11-11	FEB-11-21	FEB-21-11	FEB-21-21
-----------	-----------	-----------	-----------

Terminal End View	Terminal	Load or Line Terminal Type				
		Type	Wire	No. Per	Solid	Stranded
	11	Cu Crimp	#8-#12	1	Yes	Yes
			#12-#14	2	Yes	Yes
	21	Cu Crimp	#10	2	Yes	Yes
			#6	1	Yes	Yes
			#4	1	Yes	No

FSB1 = Single conductor boot (used to cover all crimp type & single set screw terminals)

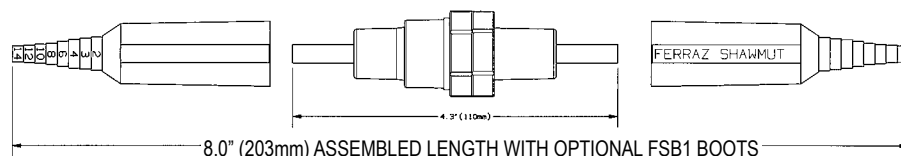

For additional information about panel mount and in-line fuseholders visit ep.mersen.com

Ratings:

Volts : 600VDC
 : 1000VDC Self-certified
Amps : 30A Maximum
SCCR : 100kA
 Temperature Rating 155° C

Approvals:

- UL Recognized to 4248, File E52283
- CSA Certified, class 6225-01



PV Fuseholders and Blocks

HPJ series for re-combiner and inverter input applications



For use with HP6J and HP10J series fuses

Designed for Mersen's HP6J (600VDC) and HP10J (1000VDC) series of photovoltaic fuses, these fuse blocks are certified for use with 90°C temperature rated conductors, an industry first. Blocks are available with box connectors, stud connectors or combination of the two. Insulators are either molded glass-filled polycarbonate or phenolic with verified dielectric strength in excess of 2500V. All fuse clips are made of high conductivity tin-plated copper.

All fuse blocks are equipped with fuse clips

Catalog Numbers and Electrical Characteristics (Box to Box Configuration)

For use with	Voltage (VDC)	Amperage (A)	Terminal Type	Wire Range (AL/ CU)	Stud Type	Catalog Number
HP6J (61-100)	1000	100	Box-Box	2/0 - #6	-	61006HPJ
HP10J (61-200)		200	Box-Box	350kcmil - #6	-	62001HPJ
HP6J (101-200)		400	Box-Box	(2) 350kcmil - #6	-	64031HPJ
HP6J, HP10J (201-400)		600	Box-Box	(2) 500kcmil - #4	-	6631HPJ
HP6J (401-600)						

Catalog Numbers and Electrical Characteristics (Box to Stud Configuration)

For use with	Voltage (VDC)	Amperage (A)	Terminal Type	Wire Range (AL/ CU)	Stud Type	Catalog Number
HP6J (61-100)	1000	100	Box-Stud	2/0 - #6	1/4-20	61041HPJ
HP10J (61-200)		200	Box-Stud	350kcmil - #6	5/16-18	62041HPJ
HP6J (101-200)		400	Box-Stud	(2) 350kcmil - #6	3/8-16	64041HPJ
HP6J, HP10J (201-400)		600	Box-Stud	(2) 500kcmil - #4	1/2-13	6641HPJ
HP6J (401-600)						

Catalog Numbers and Electrical Characteristics (Stud to Stud Configuration)

For use with	Voltage (VDC)	Amperage (A)	Terminal Type	Wire Range (AL/ CU)	Stud Type	Catalog Number
HP6J (61-100)	1000	100	Stud-Stud	-	1/4-20	61016HPJ
HP10J (61-200)		200	Stud-Stud	-	5/16-18	62011HPJ
HP6J (101-200)		400	Stud-Stud	-	3/8-16	64011HPJ
HP6J, HP10J (201-400)		600	Stud-Stud	-	1/2-13	6611HPJ
HP6J (401-600)						

Approvals:

- UL Listed to 4248-18, File E347822
- RoHS Compliant



Accessories – DFC series dead-front fuse covers

Clip-on covers, covering exposed live clips and terminals, reduce accidental contact by personnel. They are sized to fit Mersen HP6J and HP10J class J PV fuses. All DFC dead-front fuse covers are reusable when a fuse is replaced. Optional visual blown fuse indicator models illuminate to indicate an open fuse.



For use with Fuse	For use with Fuse Block	Voltage (VDC)	Amperage (A)	Visual Blown Fuse Indicator	Catalog Number	Reference Number
HP6J	610xxHPJ	600	61-100	Yes	DFC-3I	X205065
HP6J	610xxHPJ	1000	61-100	No	DFC-3	G201647
HP6J	620xxHPJ	600	101-200	Yes	DFC-12I	-
HP6J, HP10J	620xxHPJ	1000	101-200	No	DFC-12	-

For additional information about HPJ photovoltaic fuse blocks visit ep.mersen.com

PV Fuseholders and Blocks

HPBB series for re-combiner and inverter input applications

For use with Mersen size NH Photovoltaic Fuses

Designed for Mersen's HP10NH (1000VDC) and HP15NH (1500VDC) series of photovoltaic fuses. Blocks are available with screw mount tongues or stud terminals. Choose between open-style or touch-safe options.

All fuse blocks are equipped with fuse clips

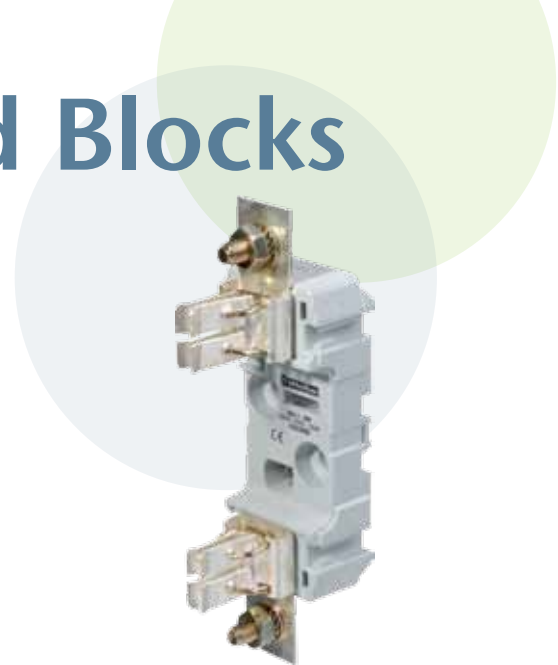

Catalog Numbers and Electrical Characteristics

For use with	Voltage (VDC)	Amperage (A)	Terminal Type	Wire Range (AL/CU)	Stud Type	Touch-Safe	Catalog Number	Reference Number
NH1	1000	250 max	Stud-Stud	-	M10	No	HPBB11PPR	A1030607
			Stud-Stud	-	M10	Yes	HPBB11PPRFS	K1032916
NH2	1000	315 max	Stud-Stud	-	M10	No	HPBB21PPR	C1037509
			Stud-Stud	-	M10	Yes	HPBB21PPRFS	D1037510
NH1XL	1500	250 max	Stud-Stud	-	M10	Yes	HPBB1XL1PPFS	Y1039598
NH2XL, NH3L	1500	500 max	Stud-Stud	-	M12	Yes	HPBB2XL3L1PPFS	Z1039599
			Stud-Bus	-	M12	Yes	HPBB2XL3L1PBFS	A1039600

Approvals

- UL Listed to 4248-18, File E362644 (Size NH1 and NH2)
- IEC 60269-2-1 Certification
- RoHS Compliant



Accessories – Fuse Handles

For use with Fuse	Catalog Number	Reference Number
NH1, NH2	NHHANDLE	P215592E
NH1XL, NH2XL, NH3L	POIGNEEPM12	Y210402

For additional information about HPBB photovoltaic fuse blocks visit ep.mersen.com

Surge Protective Devices

Surge-Trap[®] for photovoltaic applications

The Surge-Trap PV series of devices provide advanced overvoltage protection to photovoltaic systems by utilizing Mersen's optimized dynamic thermal disconnection system, which does not require additional overcurrent protection (back-up fuse) due to its high short-circuit withstand. These surge protective devices are suitable for all PV applications; large-scale, rooftop and stand-alone (off-grid) DC installations.



Catalog Numbers & Descriptions

Product Series	Catalog Number	Reference Number	No. of Poles	U_{cpv}	I_{scpv}	I_{max} (8/20 μ s)	I_n (8/20 μ s)	$U_p @ I_n$	Remote Indicator	Replacement Cartridge
ST (Modular Type)	ST600PV	Y1007421	2	600VDC	10kA	40kA	20kA	$\leq 2.0kV$	No	-
	ST600PVM	T1007578	2	600VDC	10kA	40kA	20kA	$\leq 2.0kV$	Yes	-
	ST1000PV	N1004353	3	1000VDC	10kA	40kA	20kA	$\leq 3.0kV$	No	-
	ST1000PVM	X1007581	3	1000VDC	10kA	40kA	20kA	$\leq 3.0kV$	Yes	-
STP (Pluggable Type)	STPT2-40K600V-UPV	-	2	600VDC	10kA	40kA	20kA	$\leq 2.0kV$	No	SP2-40K600V-UPV
	STPT2-40K600V-UPVM	-	2	600VDC	10kA	40kA	20kA	$\leq 2.0kV$	Yes	SP2-40K600V-UPV
	STPT2-40K1000V-YPV	83020140	3	1000VDC	10kA	40kA	20kA	$\leq 3.0kV$	No	SP2-40K1000V-PV
	STPT2-40K1000V-YPVM	83020141	3	1000VDC	10kA	40kA	20kA	$\leq 3.0kV$	Yes	SP2-40K1000V-PV
	STPT2-40K1500V-YPV	83020158	3	1500VDC	10kA	40kA	20kA	$\leq 5.0kV$	No	SP2-40K1500V-PV
	STPT2-40K1500V-YPVM	83020159	3	1500VDC	10kA	40kA	20kA	$\leq 5.0kV$	Yes	SP2-40K1500V-PV

Additional Specifications

Operating and Storage Temperature: -40°C to +85°C

Connector Type: Screw Cage

Suggested Screw Torque: 4 Nm

Wire Range: 14 to 6 AWG (6 to 25mm²) single conductor

Wire Type: 60/75°C solid/stranded copper

Approvals

- UL 1449 Type 2CA, File E210793, E468946
- EN50539-11, PV Type 2
- IEC 61643-1, Class II
- UTE C 61-740-51



Microswitch (M) – Remote Indication

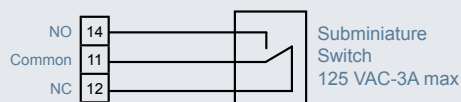
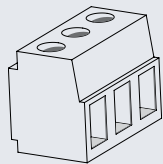

Signal Wire Range: #14 to #30 AWG (0.05 to 2.5mm²)

Auxiliary Micro-Switch Installation (optional)

Remote signaling is available on all Surge-Trap products that specify a remote indicator.

- ▶ Terminal Torque 0.27 Nm
- ▶ Cont. between Comm + NO = Product offline, not protected
- ▶ Cont. between Comm + NC = Product online, protected

Wire Management Solutions

FSPDB series for combiner box applications

Achieve a new level of ease and safety

Mersen FSPDBs introduce a new level of safety and ease for installing power distribution blocks. An IP20 level of finger-safe protection is achieved using FSPDBs, eliminating the need for special covers or custom Plexiglass sheets to protect your panels. FSPDBs (sizes 1 to 4) simply snap onto 35mm DIN-rail to provide the quickest installation. Modular design also allows for multi pole applications by use of assembly pins. FSPDBs provide a safe, convenient way of collecting PV string circuits.



Catalog Numbers and Electrical Characteristics

Voltage (VDC)	Amperage (A)		LINE			LOAD			Catalog Number	
	AL*	CU*	Openings	Wire Range		Openings	Wire Range		AL*	CU*
1500 UL	135	175	1+	2/0 - #14	70 - 2.5mm ²	1+	2/0 - #14	70 - 2.5mm ²	FSPDB1A	FSPDB1C
	135	175	1+	2/0 - #14	70 - 2.5mm ²	4+	#2 - #14	35 - 2.5mm ²	FSPDB2A	FSPDB2C
	250	310	1	350kcmil - #6 2/0 - #14	185 - 16mm ² 70 - 2.5mm ²	8	#8 - #14	8 - 2.5mm ²	FSPDB3A	FSPDB3C
600 UL 1000 Self Certified	270	335	1	400kcmil - #6	185 - 16mm ²	1	400kcmil - #6	185 - 16mm ²	FSPDB4A	FSPDB4C
	680	840	2	600kcmil - #4	300 - 25mm ²	2	600kcmil - #4	300 - 25mm ²	FSPDB5A	FSPDB5C

* AL (Aluminum) power distribution blocks are rated for 60 / 75 / 90°C, copper or aluminum conductors

* CU (Copper) power distribution blocks are rated for 60 / 75°C, copper conductors only

+ Openings are approved for multiple conductors per opening, for additional info visit ep.mersen.com

Approvals

- UL Recognized to 1059, File E73571
- CSA Component Acceptance, Class 6228-01



MPDB series for combiner box applications

The Next Generation Power Distribution Block (PDB)

Mersen MPDB series open-style power distribution blocks provide a safe and easy method of splicing cables, splitting primary power into secondary circuits and fulfilling requirements for fixed junction tap-off points. All blocks are UL and CSA approved while meeting spacing requirements for feeder and branch circuits in conjunction with UL508A and the National Electrical Code®.



Catalog Numbers and Electrical Characteristics

Voltage (VDC)	Amperage (A)		LINE			LOAD			Catalog Number	
	AL*	CU*	Openings	Wire Range		Openings	Wire Range		AL*	CU*
1000 UL	310	380	1	500kcmil - #4	250 - 25mm ²	1	500kcmil - #4	250 - 25mm ²	MPDB67401	MPDB66401
	310	380	1	500kcmil - #4	250 - 25mm ²	4	2/0 - #14	70 - 2.5mm ²	MPDB67411	MPDB66411
	310	380	1	500kcmil - #4	250 - 25mm ²	6	#2 - #14	35 - 2.5mm ²	MPDB67461	MPDB66461
	135	175	1	2/0 - #14	70 - 2.5mm ²	8	#2 - #14	35 - 2.5mm ²	MPDB67581	MPDB66581
	135	175	1	2/0 - #14	70 - 2.5mm ²	12	#10 - #14	5.5 - 2.5mm ²	MPDB67111	MPDB66111
	250	310	1	350kcmil - #6	185 - 16mm ²	15	#10 - #14	5.5 - 2.5mm ²	MPDB67621	MPDB66621
	310	380	1	500kcmil - #4	250 - 25mm ²	18	#10 - #14	5.5 - 2.5mm ²	MPDB67491	MPDB66491

Mersen has over 500 configurations of MPDB series power distribution blocks. For information on additional configurations visit ep.mersen.com

Approvals

- UL Listed to 1953, File E352417
- CSA Component Acceptance, Class 6228-01



For additional information about FSPDB and MPDB series power distribution blocks visit ep.mersen.com

PV-Rated Disconnect Switches

For combiner and re-combiner box applications

UL 98 and IEC-Rated DC Switches

Mersen offers a range of DC disconnect switches especially designed for PV applications, in 2 poles and 2x2 poles configurations for double circuit applications. The technology inside the switch and the visible contacts allow a quick, safe, and reliable DC breaking power at all current levels up to 1500VDC. The product is ready and simple to install independently of the polarity, with very limited power losses, and with a 40% smaller footprint than competition. The 1000V versions have 2 switching modules (poles) and the new 1500V versions have 3 modules.

Catalog Numbers

Part #	Description	Ref #
UL 98B 1000VDC-rated Non-Fused switches		
MD100U11	DC Switch 100A UL 2p	X1043231
MD180U22	DC Switch 180A UL 4p	Y1043232
MD200U11	DC Switch 200A UL 2p	Z1043233
MD250U11	DC Switch 250A UL 2p	A1043234
MD250U22	DC Switch 250A UL 4p	B1043235
MD320U11	DC Switch 320A UL 2p	C1043236
MD320U22	DC Switch 320A UL 4p	D1043237
MD400U11	DC Switch 400A UL 2p	E1043238
MD400U22	DC Switch 400A UL 4p	F1043239
IEC 1000 VDC-rated Non-Fused switches		
MD100E11	DC Switch 100A IEC 1000V 2p	G1043217
MD160E11	DC Switch 160A IEC 1000V 2p	H1043218
MD200E11	DC Switch 200A IEC 1000V 2p	J1043219
MD250E11	DC Switch 250A IEC 1000V 2p	K1043220
MD100E22	DC Switch 100A IEC 2x1000V 4p	L1043221
MD160E22	DC Switch 160A IEC 2x1000V 4p	M1043222
MD200E22	DC Switch 200A IEC 2x1000V 4p	N1043223
MD250E22	DC Switch 250A IEC 2x1000V 4p	P1043224
MD315E11	DC Switch 315A IEC 1000V 2p	Q1043225
MD400E11	DC Switch 400A IEC 1000V 2p	R1043226
MD500E11	DC Switch 500A IEC 1000V 2p	S1043227
MD315E22	DC Switch 315A IEC 2x1000V 4p	T1043228
MD400E22	DC Switch 400A IEC 2x1000V 4p	V1043229
MD500E22	DC Switch 500A IEC 2x1000V 4p	W1043230
1500 VDC Ratings - Please consult factory.		



1000VDC version

Highlights:

- IEC version and UL version
- Visible contacts
- 40% smaller footprint than competition
- Direct installation for floating polarity configuration
- Jumper bar available for grounded configuration

Applications:

- Medium and large power photovoltaic installations up to 1500VDC
- “Make and break” on load and provide safety isolation at string combiner box level

Approvals:

- UL98B File #E466972 WHVA
- IEC 60947-3 CE



Accessories – Handles and Shafts

Please visit ep.mersen.com for our extensive list of handles, shafts, and accessories.

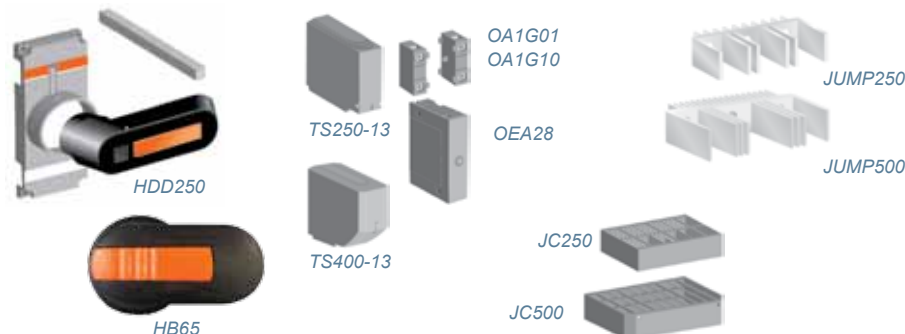

Ratings:

- Volts** : 1000VDC and 1500VDC
Amps : IEC: 100 to 500A
: UL98: 100 to 400A
SCCR : 5 to 10kA for higher ratings

For additional information about PV-rated disconnect switches visit ep.mersen.com

Disconnect Switches

DC contactors for inverter applications

High Power Switches for Inverters in PV Systems

When you need to safely and reliably interrupt the electrical current during shutdown of central inverters in grid connected solar power farms, turn to Mersen's rugged DC Contactors. Our high quality contactor reliably extinguishes electrical arcing at high voltages and is ideal for solar power systems.

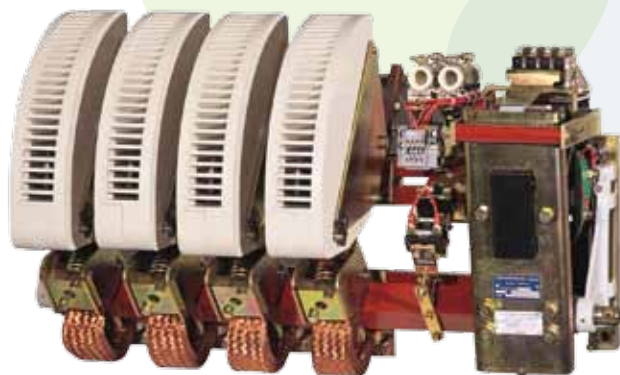

CBFC 75 series (400 to 1000A)

	Maximum Switch-off Voltage				
	400A	500A	630A	800A	1000A
1-Pole	500 VDC	500 VDC	500 VDC	500 VDC	500 VDC
2-Pole	1000 VDC	1000 VDC	1000 VDC	1000 VDC	1000 VDC
3-Pole	2000 VDC	2000 VDC	2000 VDC	2000 VDC	2000 VDC

CBC 57 series (80 to 200A)

	Maximum Switch-off Voltage		
	1250A	1600A	2000A
1-Pole	600 VDC	600 VDC	600 VDC
2-Pole	1500 VDC	1500 VDC	1500 VDC
3-Pole	2000 VDC	2000 VDC	2000 VDC
4-Pole	3000 VDC	3000 VDC	3000 VDC



Disconnectors and changeover switches for inverter applications

	FA10 Disconnecter Series	FA12 Changeover Series
Ampere rating range	500-8000	500-8000
Configuration	1-0 Open and closed	1-2 Change over
Number of poles	2	2
Operation (1)	Manual	Manual
Qty of Microswitches per position	2	2
Operating voltage	3000 V	3000 V
Dielectric withstand voltage	20kV - 50Hz - 1mn	20kV - 50Hz - 1mn
Maximum SCCR range for one pole	75-150kA	75-150kA
Mechanical endurance (1 cycle = 1 open + 1 close)	5000 cycles	5000 cycles



For additional information about DC Contactors, Disconnectors and Changeover Switches visit ep.mersen.com

Electronic Systems for Energy Management

PV String Monitoring Cards for string combiner box applications

Guarantee the long term power efficiency of PV installations

In mid- and large-scale photovoltaic (PV) installations, it is *mandatory* to properly monitor the string level production over time to guarantee long term power performance by maximizing energy production, optimizing facility management, and decreasing operations and maintenance costs.

Mersen, a worldwide leader in electrical protection solutions, is proud to deliver a string monitoring solution to be installed in the string combiner box.



WebCom Energy Data Logger

Catalog Numbers

Catalog Number	Reference Number	Description
HMMC6A	T1034626	6-String Main Card
HMAC6A	A1034632	6-String Auxiliary Card (add up to 4 Aux Cards for each Main Card)
HMPC8A	B1034633	Probe Card (monitor up to 8 external sensors for each probe card)
HMKCNA	C1034634	Connection Kit: Convert RS-485/DB9 to RS-485 line output
HMKCGA	D1034635	Configuration Kit: Includes configuration software and USB connection cable
HM2RS485COMA	D1039304	WebCom energy data logger

Highlights:

- **Efficient Built-in Power Supply** – Take power directly from the PV string, eliminating the need to purchase and install a separate power supply to power the device
- **Accuracy** – 0.5% precision compared to 5% from competitors
- **Voltage and Current Measurement** – Additional voltage measurement provides a greater level of detail and is required in many cases
- **Flexible 6-String Device** – Allows for greater flexibility (can be configured for 6, 12, 18, 24 or 30 string boxes)
- **Integrated Bus Bar** – Combines strings into 1 or 2 outputs based on ampere rating. Eliminates the need for separate comb bus bar
- **Higher Amp Rating** – Designed for string inputs up to 25A. Compare to competitor products with 15A or 20A inputs per string
- **Increased Functionality** – Option to connect up to 8 external sensors (anemometer, thermometer, sun sensor, etc...)

Ratings:

Volts : 1000VDC maximum
Amps : 25A maximum per string
Number of Strings
 : 6, 12, 18, 24, 30
Operating Temperature
 : -30°C to +70°C
Degree of Protection
 : IP20

Approvals:

- UL Recognized to 1741, File E356648
- SunSpec Alliance Certified
- EMC (electromagnetic compatibility): EN 61000-6-2, EN 61000-6-3
- Security: EN 61010-1
- Installation : IEC 61439-3, 62103



For additional information about PV String Monitoring Cards visit ep.mersen.com

Electronic Systems for Energy Management

Safety system for PV installations

Meet NEC690.12 requirements by disconnecting at the PV module level for absolute protection

Mersen is extending its HelioProtection offering with an electronic protection system to safeguard against potential electrocution hazards of PV installations. The Mersen PV safety solution provides an individual, remotely controlled shutdown feature per PV module, thanks to an electronic card called Greeneye. Greeneye can be installed either in the junction box on the back of each PV module or as an add-on, field installable junction box. In case there is a need for urgent shutdown, when activated, the Greeneye module brings the output current and voltage of the individual PV module(s) to zero. The PV installation therefore becomes fully disconnected and safe for construction, maintenance, or even in the case of fire, avoiding any risk of electrocution to personnel or firefighters.



A Highly Secure Safety System

Mersen's PV safety solution is comprised of two components, the Greeneye smart PV switch, installed at the PV module level and the Greenbrain control unit, installed in the string combiner box. The safety solution is a failsafe system. Under normal operating conditions the Greeneye modules are in the ON state, and solar power energy production is ongoing. When activated by the Greenbrain control unit, the Greeneye smart PV switch turns OFF, reducing the output of the PV module(s) to **zero volts (0V)** and **zero amperes (0A)**.

Emergency Operating Sequence

In case of emergency shutdown, the Greenbrain control unit creates an **electro-mechanical disconnection** between the inverter and string combiner box to isolate the inverter from the PV strings. Then each Greeneye smart PV switch is individually shut-down. **DC current and voltage falls to zero on all DC wires** from the PV modules to the string combiner boxes and inverters. A safety light coupled to the emergency button indicates a DC string voltage higher than 40 volts. When the safety light goes OFF the PV installation is fully safe. The PV installation can only be re-activated manually at each string combiner box as an added level of safety.

Automatic shutdown

Each Greeneye smart PV switch is equipped with a temperature sensor. If the temperature exceeds 115°C, the Greeneye smart PV switch is automatically switched to the OFF position.

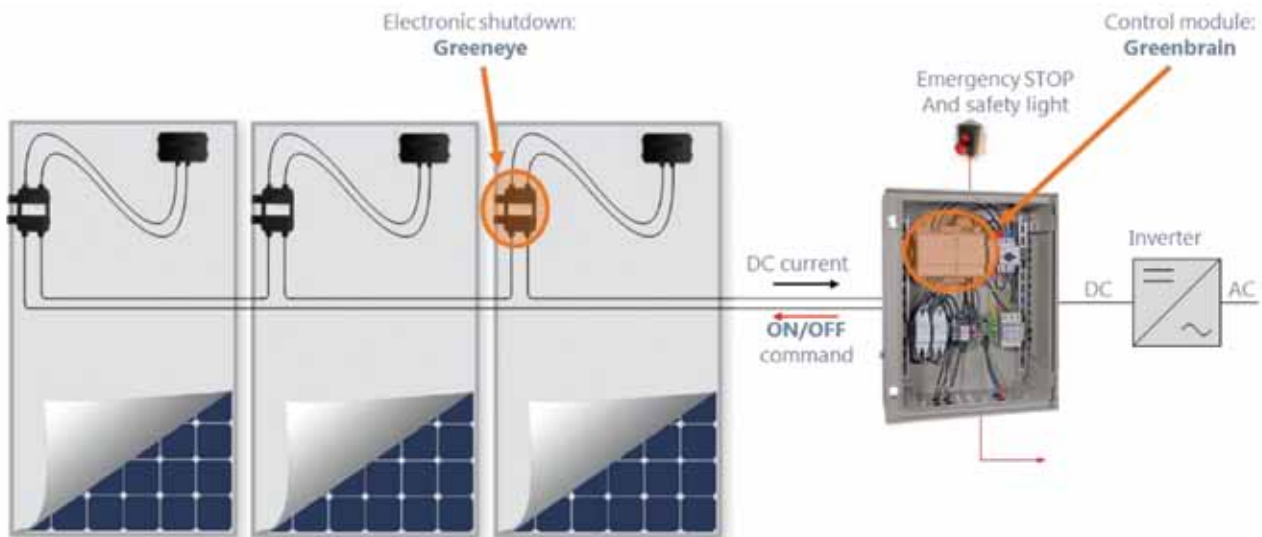

Diagram of the Mersen PV safety system

For additional information about Mersen's PV Safety Solution visit ep.mersen.com

Power Electronics Solutions

Cooling devices for inverter applications

Bring Us Your Toughest PV Cooling Challenge

Mersen integrates its extensive cooling expertise and patented heatsink technology into photovoltaic applications to make them more efficient, reliable and profitable. Mersen's engineering team will help you find innovative solutions and can also simulate your application. Our unique knowledge of air, phase change and liquid cooled heatsinks enables Mersen to help you find the right thermal protection solution for your application.

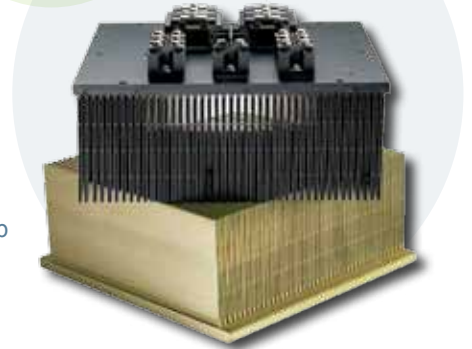

Fabfin® heatsink

Air Cooling Solutions

Mersen's air cooled Fabfin® heatsink stands out from ordinary extruded heatsinks because of its higher fins, giving it excellent performances. Using a swaging process means a variety of its higher fins and increased height-to-space ratio types of fins can be used. The Hollowfin heatsink uses the same technology but the fins are processed further to increase their density on the baseplate. Mersen offers a comprehensive range of high performance air cooled solutions, which are also available in mixed metal, dual baseplate, integrated and extrusion models.



Dual baseplate



Mixed metals



Copper

Liquid Cooling Solutions

The liquid cooled Aquamax® employs an aluminum body and copper tubes. These tubes are embedded in the aluminum body using a mandreling process that expands the copper tube into intimate contact with the aluminum body creating a very robust construction. Mersen offers numerous liquid cooling options designed for tight spaces while providing lasting performance.



Aquamax®

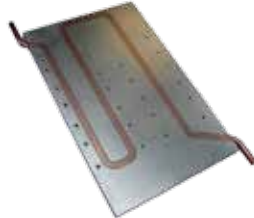

Aquasurf®

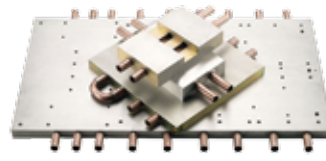

Aquasink®

Heat pipes for instantaneous cooling action

The high heat losses from press-pack or IGBT power devices can easily be conveyed outward via heat pipe cooling units. A unit consists of aluminum evaporator and condenser sections with copper heat pipes. Working fluids are chosen to suit the application (methanol, water). This heatsink offers high thermal performance, homogeneity of temperature under components, and easy maintenance.



Power Electronics Solutions

Laminated bus bar for inverter applications

Eldre is now Mersen

Eldre is now part of the Mersen family. Mersen is known worldwide for providing expertise to customers for safety and reliability of electrical power. With the addition of Eldre to the Mersen family, Mersen adds laminated bus bar to its extensive portfolio of products, creating a powerful bundled product offering for the protection of power electronics.

What is laminated bus bar?

Laminated bus bar is an engineered component consisting of layers of fabricated copper separated by thin dielectric materials, laminated into a unified structure. Sizes and applications range from surface-mounted bus bars the size of a fingertip to multilayer bus bars that exceed 20 feet in length. Laminated bus bar solutions are routinely used for low volumes up through tens of thousands per week.

Why choose laminated bus bar?

Bus bars reduce system costs, improve reliability, increase capacitance, and eliminate wiring errors. They also lower inductance and lower impedance. Plus, the physical structure of bus bars offers unique features in mechanical design. For example, complete power distribution subsystems can also act as structural members of a total system. Multilayer bus bars offer a structural integrity that wiring methods just can't match.

A reputation for quality

Mersen's reputation for outstanding technical expertise, product quality, and engineered safety is the result of over a century of design and manufacturing knowledge, coupled with state-of-the-art equipment in three ISO-9001 registered facilities. Each facility manufactures single and multilayer bus bars, as well as fully integrated solutions in which the laminated bus bar also serves as a platform for a multitude of discreet components:

- In Europe, our 5,000 m² plant in Angers is a center of excellence for laminated bus bar solutions
- In North America, our 110,000 ft² plant in Rochester, New York is a vertically integrated center of excellence for all power distribution solutions, plus AS9100C registered
- In Asia, a brand-new 6,500 m² facility in Shanghai, China offers full manufacturing capability of all power and bus bar solutions



Our commitment to quality is clearly evident from the very beginning of the design process, right through to the production of the last part. Our Quality System is designed with defect prevention in mind and is certified to AS9100. Our staff of professional engineers and experienced designers develops the tooling and manufacturing methods, procedures and process parameters to meet our customers' specifications.

With over sixty years of experience in designing laminated bus bars, and complete in-house manufacturing capability, we have the flexibility and expertise to respond to our customers' requirements through:

- quality control and quality assurance
- engineering & design
- chemical milling
- electroplating
- assembly
- epoxy encapsulation
- tool and die design and build
- metal fabrication
- metal joining
- die cutting
- laminating
- electrostatic powder coating



A WORLD LEADER
in the safety & reliability
of Solar Power.

A GLOBAL PLAYER

A global expert in materials and solutions for extreme environments as well as in the safety and reliability of electrical equipment, Mersen designs innovative solutions to address its

clients' specific needs to enable them to optimize their manufacturing process in sectors such as energy, transportation, electronics, chemical, pharmaceutical, and process industries.

MERSEN U.S.A.
374 Merrimac Street
Newburyport, MA 01950
U.S.A.
T : 978 462 6662
F : 978 462 0181

MERSEN France
15 Rue Jacques de Vaucanson
F-69720 Saint Bonnet de Mure
France
T : +33 (0)4 72 22 66 11
F : +33 (0)4 72 22 67 13

MERSEN Toronto
6200 Kestrel Road
Mississauga, Ontario
Canada L5T 1Z1
T : 416 252 9371
F : 416 252 6572

MERSEN Shanghai
No.55-A6. Shu Shan Road
Songjiang 201611
Shanghai
Tel: +8621 67602388