

NEW PRODUCTS

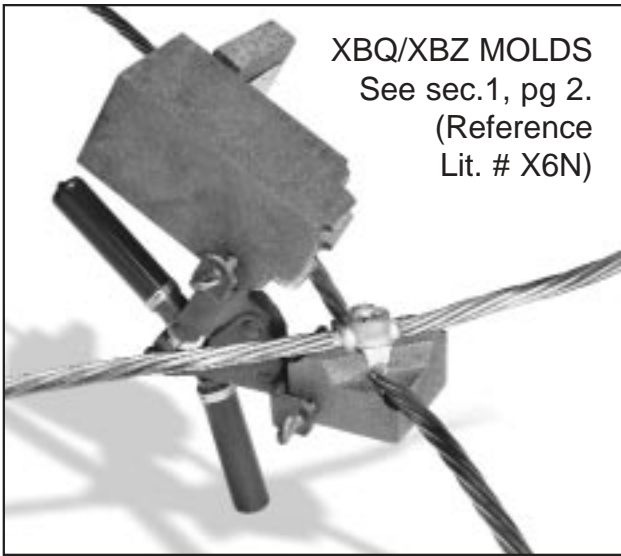

XBQ/XBZ MOLDS
See sec.1, pg 2.
(Reference
Lit. # X6N)

The CADWELD® XB molds are the quickest, most efficient way to make lapped, horizontal X-style connections on solid or concentric stranded cable for a variety of installations.

For cable-to-cable X-style connections at power substations and other commercial and industrial sites, there's never been a faster or easier way to make a reliable CADWELD connection. This two-piece mold lets you make connections in a trench in about half the time it would take with compression connectors or other exothermic products — and at a fraction of the cost.



TELECOM LUGS
(Reference Lit. # E108S)

ERICO® can provide the ideal grounding and bonding products for wireless telecom applications.

- One CADWELD mold for 7 lug sizes - minimizes inventory of molds
- Multiple molds are replaced with ONE versatile mold that utilizes inexpensive conductor sleeves (no sleeve required for #2 concentric cable)
- No multiple tools or dies required as with crimped connections
- Superior lug-to-cable connection quality - welded lug connection will not loosen or corrode
- Ideal for the grounding and bonding requirements of the codes & standards: NEC, CEC, TIA, BICSI



**GN CONNECTION
KITS for Wire to
Ground Rods.**
(Reference
Lit. # X6M)

Whether you're working in telecommunications, electric distribution or cable television, here's everything you need to make a permanent and reliable wire-to-ground rod connection at the lowest cost and with maximum convenience. The CADWELD GN Connection Kit contains all materials and necessary tools to make sixty CADWELD connections quickly, easily and inexpensively. With replacement mold and weld-metal kits, you can make hundreds more.

The GN mold clamps to the side of ground rods, so "mushroomed" heads are no problem. You can make multiple connections to a single rod.

CADWELD[®]

**WELDED
ELECTRICAL CONNECTIONS**

ERICO[®]

ERICO, Inc., 34600 Solon Road, Solon, Ohio 44139 • PHONE: 800/677-9089 • FAX: 800/677-8131

INDEX

Type	Sec	Pg
Cable to Cable		
XBQ/XBZ	1	5
PC	1	2
PC	1	3
PG	1	3
PG ONE-SHOT	1	9
PG	1	10
PH	1	11
PT	1	8
PG	1	8
SS	1	10
TA	1	3
XA	1	6
XB	1	5
Cable to Ground Rod		
GB	2	14
GN Kits	2	13
GR	2	2
GR ONE-SHOT	2	12
GT	2	4
GT ONE-SHOT	2	12
GY	2	6
NC	2	8
ND	2	10
NT ONE-SHOT	2	12
NX ONE-SHOT	2	12
Cable to Steel		
HA (Steel)	3	5
HA (Pipe)	3	2
HB (Pipe)	3	3
HC	3	6
HS (Steel)	3	5
HT	3	6
VB	3	9
VF	3	9
VG	3	10
VN	3	4
VS (Steel)	3	7
VS (Pipe)	3	8
VT	3	10
VV	3	11
Cable to Lug		
GL	4	4
LA	4	2
NEMA Lugs	4	2
Prefabricated Lug Bonds	4	5
Telecom Lugs	4	6

Type	Sec	Pg
Cable to Busbar		
LJ	5	3
LQ	5	2
Busbar		
BA	6	3
BQ	6	2
EP	6	3
Busbar to Steel Surface		
BW	7	2
CC	7	3
CF	7	2
CG	7	3
CH	7	3
Cable to Rebar		
RC	8	8
RD	8	6
RJ	8	10
RR	8	4
Cable to Rail		
ST	9	2
TP	9	2
W	9	3
Cast Ground Plates, Receptacles & Studs		
Aircraft Grounding Receptacles		
B165, B165R, B166, B167	10	4
Cast Ground Plates	10	3
Cast Ground Plate Connectors		
HV, HV/VE, HV/VF	10	2
Cast Ground Plate Assemblies	10	5
GB	10	6
GB/GR	10	6
GB/GT	10	6
HX	10	8
HV	10	8
RA	10	7
RB	10	7

Type	Sec	Pg
Materials, Tools & Accessories		
B117A, B, C	A	3
B120	A	10
B133xx & B112	A	3
B134 & B135	A	8
B136A	A	6
B136B	A	6
B137	A	10
B140A	A	3
B141A	A	3
B159M	A	9
B159 & B160	A	8
B159H & B160H	A	8
B159V & B160V	A	8
B159VT & B160VT	A	8
B265	A	4
B321-30	A	10
B396	A	9
B399AM & B399BM	A	9
B827A	A	9
Earth Systems Tester	A	12
Ground Rod Drivers	A	10
L160 & L159	A	8
Molds	A	2
Reference Material	A	12
Split Crucible Molds	A	7
T111	A	5
T304	A	11
T305	A	11
T306	A	11
T313	A	4
T314	A	4
T315A	A	11
T319	A	5
T320	A	10
T321	A	4
T372A	A	5
T328D	A	6
T329	A	11
T331	A	11
T358	A	5
T378L	A	2
T393	A	2
T394	A	6
T396	A	11
T403	A	3
T427	A	3
Wear Plates	A	7
Weld Metal	A	2
XLB974-B2	A	11



INDEX

ALPHABETICAL LISTING OF MOLDS & GROUNDING ACCESSORIES

Type	Sec	Pg	Type	Sec	Pg	Type	Sec	Pg
BA	.6	- 3	HC	.3	- 6	RA	.10	- 7
BQ	.6	- 2	HS	.3	- 5	RB	.10	- 7
BW	.7	- 2	HT	.3	- 6	RC	.8	- 8
B165 & B165R	.10	- 4	HV	.10	- 2	RD	.8	- 6
B166 & B167	.10	- 4	HV/VE	.10	- 2	RJ	.8	- 10
CC	.7	- 3	HV/VF	.10	- 2	RR	.8	- 4
CF	.7	- 2	HV (to steel surface)	.10	- 8	SS	.1	- 10
CG	.7	- 3	HX	.10	- 8	ST	.9	- 2
CH	.7	- 3	LA	.4	- 2	TA	.1	- 3
EP	.6	- 3	LJ	.5	- 3	Telecom Lugs	.4	- 6
GB	.2	- 14	LQ	.5	- 2	TP	.9	- 2
GB	.10	- 6	NC	.2	- 8	VB	.3	- 9
GB/GR	.10	- 6	ND	.2	- 10	VF	.3	- 9
GB/GT	.10	- 6	NEMA Lugs	.4	- 2	VG	.3	- 10
GL	.4	- 4	NT ONE-SHOT	.2	- 12	VN	.3	- 4
GN Kits	.2	- 13	NX ONE-SHOT	.2	- 12	VS	.3	- 7
GR	.2	- 2	PC	.1	- 3	VS (Pipe)	.3	- 8
GR ONE-SHOT	.2	- 12	PG	.1	- 3	VT	.3	- 10
GT	.2	- 4	PG	.1	- 8	VV	.3	- 11
GT ONE SHOT	.2	- 12	PG	.1	- 10	W	.9	- 3
GY	.2	- 6	PG ONE-SHOT	.1	- 9	XA	.1	- 6
HA	.3	- 5	PH	.1	- 11	XB	.1	- 6
HA (Pipe)	.3	- 2	Prefabricated Lug Bonds	.4	- 5	XBQ/XBZ	.1	- 5
HB (Pipe)	.3	- 3	PT	.1	- 8			

INTRODUCTION & ORDERING INFORMATION

HOW TO ORDER CADWELD PRODUCTS

This catalog lists the most popular CADWELD connections using solid or concentric stranded copper conductor, insulated or bare. Look in the index for the connection you need. To save time and money, avoid non-catalog items or specials whenever possible.

If you cannot find the connection you need, contact ERICO or your local distributor or agent. We have designed over 45,000 connections, and “specials” are designed every day.

1. What connection do you want?

Available connections are listed in the pictorial index at the beginning of each section which shows the degree of difficulty in making the connection, and ease of mold cleaning. We strongly recommend that wherever possible you use molds listed in this catalog. After selecting the connection, turn to the appropriate page and select the mold, weld metal and tools you need.

2. Only the most popular CADWELD connections are listed in this catalog.

For CADWELD EXOLON connections, ordering information is shown on page XI.

3. What are the conductor sizes?

This catalog covers connections between solid or concentric stranded copper conductors to each other, to lugs, to ground rods, to rebar, to rail and to special grounding accessories. For sizes not listed, contact your local CADWELD distributor, agent, or ERICO.

Note: Other publications describe connections to conductors of copperclad, high voltage copper, aluminum, busbar, lightning protection cable, steel cable, etc.

4. You must have the following to make a weld:

- 4.1. Mold to fit your conductors
- 4.2. Weld metal required by your mold
- 4.3. Handle clamps or frame
- 4.4. Flint ignitor (included with handle clamps and frames)
- 4.5. If using CADWELD EXOLON, you need a Relia-Start™ battery instead of a flint ignitor.
- 4.6. Lugs, sleeves, packing material listed on the page with the mold.



ORDERING INFORMATION & INTRODUCTION

Sample Index Page

Section Headings by Application Type

SECTION 1 CABLE TO CABLE CONNECTIONS

NAME	PAGE	TYPE	EASE	SPLIT	NAME	PAGE	TYPE	EASE	SPLIT
Horizontal Parallel	1-8	PG	1	*	Horizontal Tee	1-4	TA	1	*
	1-8	PT	1	V		Horizontal X	1-6	XA	1
Horizontal Splice	1-10	PG	1	*	Parallel Tap		1-6	XT	1
	1-10	BS	1	V		Vertical Parallel	1-8	PC	1
Horizontal Tee	1-4	PC	1	*	Ground Rod Splice		1-11	PH	1
	1-4	PG	1	V					

For other connections not listed in this section, see page 1-32

SECTION 2 CABLE TO GROUND RODS OR OTHER ROUNDS

NAME	PAGE	TYPE	EASE	SPLIT	NAME	PAGE	TYPE	EASE	SPLIT
Cable to Ground Rod	2-2	GR	1	V	Cable to Ground Rod (One-Shot™)	2-12	GR	1	V
	2-4	GT	1	V		2-12	GT	1	V
	2-4	GY	1	V		2-12	NT	1	V
	2-8	NC	1	V		2-12	NO	1	V
	2-10	ND	1	*		Ground Rod Splice	2-13	DS	1

For other connections not listed in this section, see page 2-32

SECTION 3 CABLE TO STEEL OR CAST IRON

NAME	PAGE	TYPE	EASE	SPLIT	NAME	PAGE	TYPE	EASE	SPLIT
Horizontal Cast Iron Surface & Pipe	3-3	HB	1	*	Horizontal Steel Surface	3-5	HA	1	*
Horizontal Steel Pipes	3-2	HA	1	*		3-5	HCB	1	*

VI ERICO, Inc. 34800 Solar Rd. • Solar, Ohio 44139 • 800-240-3WELD • FAX: 800-677-8131 • www.erico.com

All connections in this index are coded as follows according to their ease of use:

- 1 Preferred
- 2 Easily and commonly used
- 3 More difficult - use code 1 or 2 if possible by bending cables, prefabricating, using two connections, etc.
- 4 Difficult / more costly / has limitations. Use another type if possible or contact your CADWELD representative for assistance.

Split Codes define the mold as follows:

V Vertically split through crucible.

* Not vertically split through crucible, or depends on conductor size

Page reference to location in A1A catalog for details.

Connection

Mold Type

SECTION 1 CABLE TO CABLE CONNECTIONS

NAME	PAGE	TYPE		EASE	SPLIT	NAME	PAGE	TYPE		EASE	SPLIT
Horizontal Parallel	1-8	PG		1	*	Horizontal Tee	1-4	TA		1	*
	1-8	PT		1	V		Horizontal X	1-6	XA		1
Horizontal Splice	1-10	PG		1	*			1-6	XB		1
	1-10	SS		1	V	Parallel Tap	1-3	PC		1	V
Horizontal Tee	1-4	PC		1	*		Vertical Parallel	1-11	PH		1
	1-4	PG		1	V						

PG Style
Now Available
as ONE-SHOT
Connection

For other connections not listed in this section, see page 1-12

SECTION 2 CABLE TO GROUND RODS OR OTHER ROUNDS

NAME	PAGE	TYPE		EASE	SPLIT	NAME	PAGE	TYPE		EASE	SPLIT
Cable to Ground Rod	2-2	GR		1	V	Cable to Ground Rod (ONE-SHOT)	2-12	GR		1	V
	2-4	GT		1	V		2-12	GT		1	V
	2-6	GY		1	V		2-12	NT		1	V
	2-8	NC		1	V		2-12	NX		1	V
	2-10	ND		1	*		Ground Rod Splice	2-13	GN		1
					2-14	GB			1	V	

For other connections not listed in this section, see page 2-14

SECTION 3 CABLE TO STEEL OR CAST IRON

NAME	PAGE	TYPE		EASE	SPLIT	NAME	PAGE	TYPE		EASE	SPLIT
Horizontal Cast Iron Surface & Pipe	3-3	HB		1	*	Horizontal Steel Surface	3-5	HA		1	*
Horizontal Steel Pipes	3-2	HA		1	*		3-6	HC		1	*



SECTION 3 CABLE TO STEEL OR CAST IRON

NAME	PAGE	TYPE		EASE	SPLIT	NAME	PAGE	TYPE		EASE	SPLIT
Horizontal Steel Surface	3-5	HS		1	V	Vertical Steel Surface	3-10	VG		1	V
	3-6	HT		1	V		3-4	VN		1	*
Vertical Steel Pipes	3-8	VS		1	V		3-7	VS		1	*
Vertical Steel Surface	3-9	VB		2	V		3-10	VT		1	*
	3-9	VF		1	V		3-11	VV		1	V

For other connections not listed in this section, see page 3-12

SECTION 4 CABLE TO LUGS AND PREFABRICATED LUG ASSEMBLIES

NAME	PAGE	TYPE		EASE	SPLIT	NAME	PAGE	TYPE		EASE	SPLIT
Cable to Lug	4-3	GL		1	V	NEMA Lugs	4-5				
	4-2	LA		1	V	Prefabricated Lug Assemblies	4-4				

SECTION 5 CABLE TO BUSBAR OR LUG

NAME	PAGE	TYPE		EASE	SPLIT	NAME	PAGE	TYPE		EASE	SPLIT
Cable to Busbar	5-3	LJ		1	V	Cable to Busbar	5-2	LQ		2	V



For other connections not listed in this section, see page 5-4

SECTION 6 BUSBAR CONNECTIONS

NAME	PAGE	TYPE		EASE	SPLIT	NAME	PAGE	TYPE		EASE	SPLIT
Busbar	6-3	BA		1	V	Busbar	6-3	EP		1	V
	6-2	BQ		1	V						

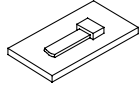

For other connections not listed in this section, see page 6-4

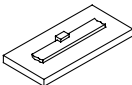
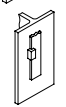
SECTION 7 BUSBAR TO STEEL SURFACE CONNECTIONS

NAME	PAGE	TYPE		EASE	SPLIT	NAME	PAGE	TYPE		EASE	SPLIT
Busbar to Steel Surface	7-2	BW		1	V	Busbar to Steel Surface	7-3	CG		1	V
	7-3	CC		1	V		7-3	CH		1	V
	7-2	CF		1	V						

For other connections not listed in this section, see page 7-4

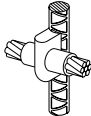
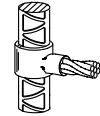
SECTION 8 CABLE TO REBAR CONNECTIONS

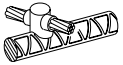
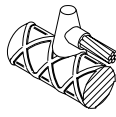
NAME	PAGE	TYPE		EASE	SPLIT	NAME	PAGE	TYPE		EASE	SPLIT
Cable to Rebar	8-8	RC		1	V	Cable to Rebar	8-10	RJ		1	V
				1	V					1	V
	8-6	RD		1	V	8-4	RR		1	V	

For other connections not listed in this section, see page 8-12

SECTION 9 CABLE TO RAIL OR STRUCTURES

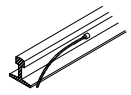
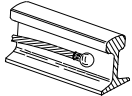
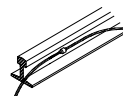

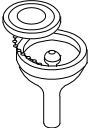
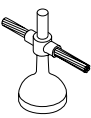
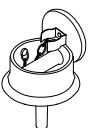
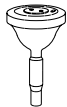
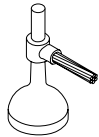
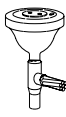

NAME	PAGE	TYPE		EASE	SPLIT	NAME	PAGE	TYPE		EASE	SPLIT
Cable to Rail	9-2	ST		1	V	Cable to Rail or Structure	9-3	Type W		1	V
	9-2	TP		1	V						

SECTION 10 GROUND PLATES, AIRCRAFT GROUNDING RECEPTACLES

NAME	PAGE	TYPE		EASE	SPLIT	NAME	PAGE	TYPE		EASE	SPLIT
Aircraft Grounding Receptacles	10-4			1		Aircraft Grounding Receptacle Connections	10-7	RB		1	V
Aircraft Grounding Receptacle Connections	10-4			1			10-6	GB		1	V
	10-7	RA		1	V		10-6	GB/GR		1	V

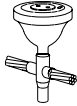
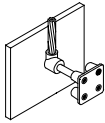
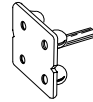
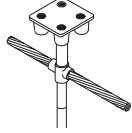
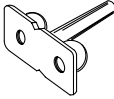
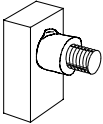

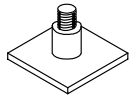
SECTION 10 GROUND PLATES, AIRCRAFT GROUNDING RECEPTACLES

NAME	PAGE	TYPE		EASE	SPLIT	NAME	PAGE	TYPE		EASE	SPLIT
Aircraft Grounding Receptacle Connections to Ground Rods	10-6	GB/GT		1	V	Cast Ground Plate Connections	10-2	HV/VF		1	V
Cast Ground Plates	10-3			1		Cast Ground Plate Assemblies	10-5			1	V
	10-3			1		Steel or Copper Studs to Steel Surface	10-8	HV		1	V
Cast Ground Plate Connections	10-2	HV		1	V		10-8	HX		1	V
	10-2	HV/VE		1	V						

**THE FOLLOWING INDEX LISTS UNCATALOGED
CONNECTIONS AVAILABLE FOR UNUSUAL APPLICATIONS**

Type	Category	Pg	Type	Category	Pg	Type	Category	Pg
BB	Busbar	6-4	FR	Cu Tube to Busbars/Lugs	11-1	MV	Cable to Cu Tube	11-2
BC	Busbar	6-4	FS	Cu Tube to Busbars/Lugs	11-1	MW	Cable to Cu Tube	11-2
BD	Busbar	6-4	FT	Cu Tube to Ground Rods	11-1	MX	Cable to Cu Tube	11-2
BF	Busbar	6-4	FV	Cu Tube to Ground Rods	11-1	MY	Cable to Cu Tube	11-2
BG	Busbar	6-4	GD	Cable to Ground Rod	2-15	NA	Cable to Cu Tube	11-2
BH	Busbar	6-4	GE	Cable to Ground Rod	2-15	ND	Cable to Ground Rod	2-10
BJ	Busbar	6-4	GF	Cable to Ground Rod	2-15	PA	Cable to Cable	1-12
BK	Busbar	6-4	GG	Cable to Ground Rod	2-15	PB	Cable to Cable	1-12
BL	Busbar	6-4	GH	Cable to Ground Rod	2-15	PD	Cable to Cable	1-12
BM	Busbar	6-4	GJ	Cable to Ground Rod	2-15	PJ	Cable to Cable	1-12
BN	Busbar to Ground Rod	6-4	GK	Cable to Ground Rod	2-15	PK	Cable to Cable	1-12
BR	Busbar	6-4	GM	Cable to Ground Rod	2-15	PL	Cable to Busbar/Lug	5-4
BS	Busbar	6-4	GN	Cable to Ground Rod	2-15	PM	Cable to Cable	1-12
BT	Busbar	6-4	GP	Cable to Ground Rod	2-15	PN	Cable to Cable	1-12
BV	Busbar	6-4	GQ	Cable to Ground Rod	2-15	PP	Cable to Cable	1-12
BX	Busbar to Steel	7-4	GS	Cable to Ground Rod	2-15	PQ	Cable to Cable	1-12
BY	Busbar to Steel	7-4	GV	Cable to Ground Rod	2-15	PR	Cable to Cable	1-12
CA	Busbar to Steel	7-4	GW	Cable to Ground Rod	2-15	RE	Cable to Rebar	8-12
CB	Busbar to Steel	7-4	GX	Cable to Ground Rod	2-15	RF	Cable to Rebar	8-12
CD	Busbar to Steel	7-4	HE	Cable to Cast Iron	3-12	RG	Cable to Rebar	8-12
CJ	Busbar to Steel	7-4	HF	Cable to Steel	3-12	RH	Cable to Rebar	8-12
CK	Busbar to Steel	7-4	HG	Cable to Steel	3-12	RK	Cable to Rebar	8-12
CL	Busbar to Ground Rod	11-2	HH	Cable to Steel	3-12	RL	Cable to Rebar	8-12
CM	Busbar to Ground Rod	11-2	HJ	Cable to Steel	3-12	RM	Cable to Rebar	8-12
CN	Busbar to Ground Rod	11-2	HK	Cable to Steel	3-12	RN	Cable to Rebar	8-12
CP	Busbar to Ground Rod	11-2	HL	Busbar to Steel	7-4	RP	Cable to Rebar	8-12
CQ	Busbar to Ground Rod	11-2	HM	Busbar to Steel	7-4	RQ	Cable to Rebar	8-12
CR	Busbar to Ground Rod	11-2	HN	Busbar to Steel	7-4	RT	Cable to Rebar	8-12
CS	Busbar to Ground Rod	11-2	LB	Cable to Busbar/Lug	5-4	RV	Cable to Rebar	8-12
DC	Busbar to Steel	7-4	LC	Cable to Busbar/Lug	5-4	RW	Cable to Rebar	8-12
DD	Busbar to Steel	7-4	LD	Cable to Busbar/Lug	5-4	SC	Cable to Cable	1-12
DE	Busbar	6-4	LE	Cable to Busbar/Lug	5-4	SD	Cable to Cable	1-12
DF	Busbar to Steel	7-4	LF	Cable to Busbar/Lug	5-4	SE	Cable to Cable	1-12
DJ	Busbar	6-4	LG	Cable to Busbar/Lug	5-4	SF	Cable to Rebar	8-12
DM	Cable to Busbar/Lug	5-4	LH	Cable to Busbar/Lug	5-4	SR	Cable to Rebar	8-12
DN	Cable to Busbar/Lug	5-4	LK	Cable to Busbar/Lug	5-4	SV	Cable to Cable	1-12
DP	Cable to Cu Tube	11-2	LL	Cable to Busbar/Lug	5-4	TC	Cable to Cable	1-12
DQ	Cable to Ground Rod	2-14	LM	Cable to Busbar/Lug	5-4	TD	Cable to Cable	1-12
DR	Cable to Rebar	8-12	LN	Cable to Busbar/Lug	5-4	TE	Cable to Cable	1-12
DS	Cable to Busbar/Lug	5-4	LP	Cable to Busbar/Lug	5-4	TF	Cable to Cable	1-12
DT	Cable to Rebar	8-12	LR	Cable to Busbar/Lug	5-4	TL	Cable to Cable	1-12
EA	Busbar	6-4	LS	Cable to Busbar/Lug	5-4	TV	Cable to Cable	1-12
EB	Busbar	6-4	LT	Cable to Busbar/Lug	5-4	TW	Busbar	6-4
EC	Busbar	6-4	LV	Cable to Busbar/Lug	5-4	TX	Busbar	6-4
ED	Busbar	6-4	LW	Cable to Busbar/Lug	5-4	VA	Cable to Steel	3-12
EE	Busbar	6-4	LX	Cable to Busbar/Lug	5-4	VC	Cable to Steel	3-12
EN	Busbar	6-4	LY	Cable to Busbar/Lug	5-4	VE	Cable to Steel	3-12
EQ	Busbar	6-4	MA	Cable to Busbar/Lug	5-4	VH	Cable to Cast Iron	3-12
ER	Busbar	6-4	MB	Cable to Busbar/Lug	5-4	VJ	Cable to Cast Iron	3-12
ES	Busbar	6-4	MC	Cable to Busbar/Lug	5-4	VK	Cable to Cast Iron	3-12
ET	Busbar	6-4	MD	Cable to Busbar/Lug	5-4	VL	Cable to Cast Iron	3-12
EV	Busbar	6-4	ME	Cable to Busbar/Lug	5-4	VR	Cable to Cast Iron	3-12
EW	Cu Tube to Busbars/Lugs	11-1	MF	Cable to Busbar/Lug	5-4	VW	Cable to Ground Rod	2-15
FD	Cu Tube to Cu Tube	11-1	MG	Cable to Busbar/Lug	5-4	VX	Cable to Steel	3-12
FE	Cu Tube to Cu Tube	11-1	MH	Cable to Cu Tube	11-2	XC	Cable to Cable	1-12
FF	Cu Tube to Cu Tube	11-1	MJ	Cable to Cu Tube	11-2	XD	Cable to Cable	1-12
FG	Cu Tube to Cu Tube	11-1	MK	Cable to Cu Tube	11-2	XF	Cable to Cable	1-12
FH	Cu Tube to Cu Tube	11-1	ML	Cable to Cu Tube	11-2	XG	Cable to Cable	1-12
FJ	Cu Tube to Cu Tube	11-1	MM	Cable to Cu Tube	11-2	XJ	Cable to Rebar	8-12
FK	Cu Tube to Cu Tube	11-1	MP	Cable to Cu Tube	11-2	XT	Cu Tube to Cu Tube	11-1
FL	Cu Tube to Cu Tube	11-1	MQ	Cable to Cu Tube	11-2	YC	Cable to Cable	1-12
FM	Cu Tube to Cu Tube	11-1	MR	Cable to Cu Tube	11-2	YD	Cable to Cable	1-12
FN	Cu Tube to Busbars/Lugs	11-1	MS	Cable to Cu Tube	11-2	YE	Cable to Cable	1-12
FP	Cu Tube to Busbars/Lugs	11-1	MT	Cable to Cu Tube	11-2	YR	Cable to Cable	1-12



Developed in 1988, **CADWELD EXOLON** is a significant advance in welded electrical connections. The metallurgy is the same as the standard CADWELD connection approved by over 70% of electric utilities in the USA — but the virtual elimination of visible smoke plus a unique electric starting system makes this improved process easier and more convenient than ever before.

Most connections listed in this catalog can be ordered in the CADWELD EXOLON configuration. Ordering information is shown below.

HOW TO ORDER CADWELD EXOLON

1. To order CADWELD EXOLON products, just specify molds and weld metal from the catalog and add an "XL" prefix.

Example: TAC2Q2Q becomes XLTAC2Q2Q, and 150 becomes XL150.
2. If the weld metal shown in the catalog shows more than one tube required such as 2-#200, you must specify #XL400 to get the correct size filters.

Example: XLTAD-4L3Q: XL400
3. The following molds require a price key change:
 - "C" price key molds using 2-#150 weld metals change to XLD price key.
 - "E" price key molds using 2-#150 weld metals change to XLJ price key.
 - "H" price key molds using 2-#150 weld metals, contact ERICO.
 - "M" price key molds using 2-#150 weld metals change to XLV price key.
 - "R" price key molds using 2-#150 weld metals change to XLF price key.
 - "T" price key molds, ALL change to XLP price key.
Example: TAC3Q3Q using 2-#150 weld metals change to XLTAD3Q3Q using #XL300 weld metal
4. Filters and ignitors are included with the weld metal. XL filters and ignitors are not sold separately.
5. The ignitor can be used only once and then must be discarded. Filters will last as specified in the instructions supplied with each mold.
6. A Relia-Start electric starter, part number XLB971A1 (battery, charger, carrying case and connecting cable), is required for XL weld metal. There is no starting material in the XL weld metal tube. Batteries operate about 200 starts before recharging from 120 VAC is required. The charger, all electrical connections and instructions are included in the battery case.
7. Baffle with cover is required for larger molds. Estimated life of the baffle is 500 welds.

XLB972A1 Baffle is required for molds using XL200 and XL250 weld metals.

XLB973A1 Baffle is required for molds using XL300 to XL750 weld metals.
8. For EZ Change Handles, add XL prefix. (Flint ignitor not included.)
9. Welding Tray, part number XLB974B2, is used under the mold to protect cables and equipment from hot materials.

OTHER INFORMATION

Certain tools may be required for various connections.

If required, these tools are listed on the same page as the connection and in Section A.

- Some tools listed in Section A can save you a lot of time.
- Also refer to A9E, Contractor Tips, to make your job easier, and learn about labor saving ideas.

Prices for standard products are shown in Price List G285P

For other CADWELD literature, videos and software, See Section C.

For all your connection needs — we're only a phone call away.

Phone: 800-677-9089

Fax: 800-677-8131

or call your local CADWELD distributor, agent, or CADWELD Regional Sales Manager

REQUIRED TOOLS SUMMARY:

Required tools are listed with each mold. For your reference, handle clamps and/or frame are summarized below.

<u>MOLD</u>	<u>REQUIRED</u>
A*	Includes frame with handle
C, Q & R	Requires L160
D, F & Z	Requires L159
E*	Includes frame but also requires L160
J*	Includes frame but also requires L159
K*, M* & V*	Includes frame with handles

* To order mold only – without handles or frame – add suffix “M” to mold part number.



GROUNDING CONNECTION SPECIFICATION

All grounding connections of copper to copper and copper to steel conductors of #8 and larger sized conductors shall be CADWELD exothermic welded connections. Conductors spliced with a CADWELD exothermic welded connection shall be considered as a continuous conductor, as stated in the notes accompanying NEC 250-50, 250-64, 250-68, 250-70 and IEEE Std 80 – 1986.

All grounding connections to equipment shall use bolted lugs. When the conductor is #8 and larger, the lug shall be joined to the conductor by the CADWELD process, otherwise use listed compression lugs which meet IEEE Std 837 – 1989.

THE CADWELD MOLD NUMBERING SYSTEM

The CADWELD Mold Part Number gives, in code, the complete information about the mold
 – Type of connection, mold price key, and conductor size(s)

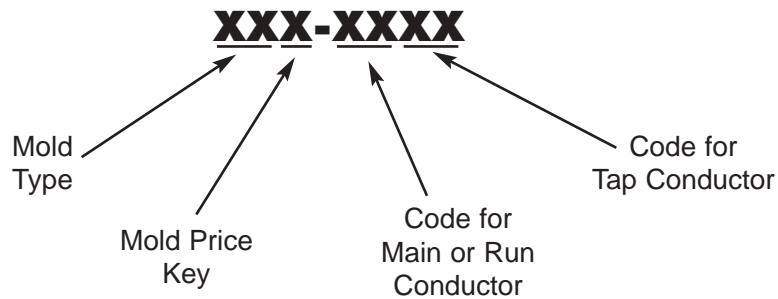

EXAMPLES

TAD-4L3Q

Type TA Price Key D 750 kcmil Run 500 kcmil Tap

GTC-182V

Type GT Price Key C 3/4" Copper Clad Ground Rod 250 kcmil Tap

SSC-3D

Type SS Price Key C 350 kcmil Tap

VSC-2C-V3

Type VS Price Key C 1/0 Cable Vertical Pipe 3" IPS

Conductor codes are listed in Section B

NOTES...



XBQ/XBZ
PAGE 5

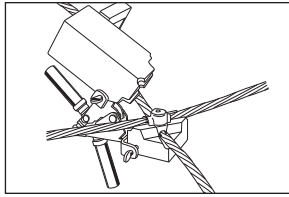

XB
Page 6

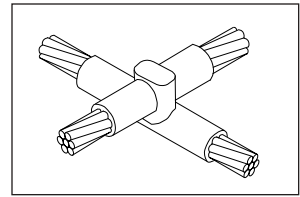

PC
Page 2

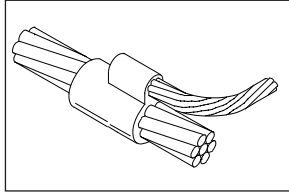

PG
Page 8

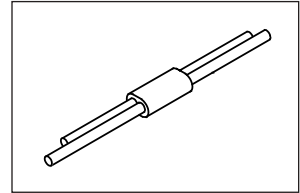

TA
Page 3

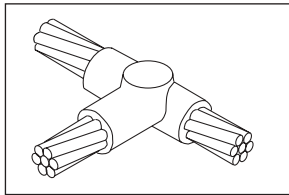

PT
Page 8

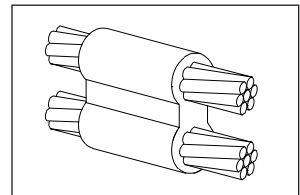

PC
Page 3

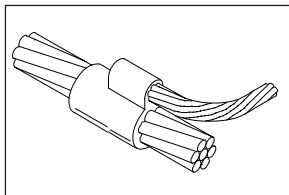

SS
Page 10

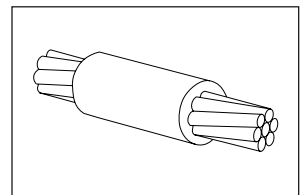

PG
Page 3

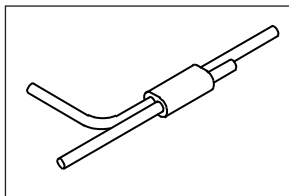

PG
Page 10

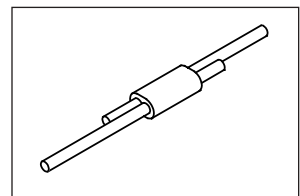

XA
Page 6

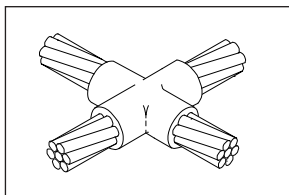

PH
Page 11

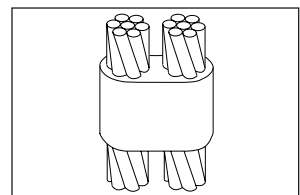

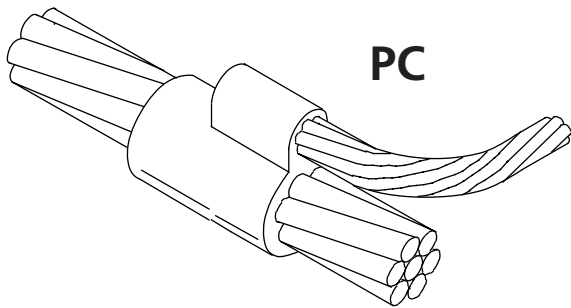

PARALLEL TAP CONNECTIONS

- Parallel tap connection of horizontal cables.
- Solid conductor may be either copper or Copperweld®.
- Concentric strand copper cable unless otherwise noted.
- **Bold letter** in mold part number is the price key.

REQUIRED TOOLS

Handle Clamps **L160** for *C Price Key* Molds

Flint Ignitor **T320** (Included with handle clamp but also available separately)

SUGGESTED TOOLS

Cable Cleaning Brush	T313 or T314
Slag Removal Spade	B136A or B136B
Mold Cleaning Brush	T394
Cable Clamp	B265
Torch Head	T111

ACCESSORIES

See Section A

CABLE SIZE		MOLD PART NO.	WELD METAL
Run	Tap		
6 SOL	6 SOL	PCC -1G1G	25
6	6	PCC -1H1H	25
4	4	PCC -1L1L	32
	6	PCC -1L1H	32
	6 SOL	PCC -1L1G	32
	8 SOL	PCC -1L1D	32
2 SOL	6 SOL	PCC -1T1G	32
	6	PCC -1T1H	32
	2 SOL	PCC -1T1T	65
	2	PCC -1T1V	65
	1/0	PCC -1T2C	65
	2/0	PCC -1T2G	65
2	2	PCC -1V1V	65
	4	PCC -1V1L	45
	6	PCC -1V1H	32
	6 SOL	PCC -1V1G	32
	8 SOL	PCC -1V1D	32
1	2	PCC -1Y1V	65
	4	PCC -1Y1L	45
	6	PCC -1Y1H	45
	6 SOL	PCC -1Y1G	45
	8 SOL	PCC -1Y1D	45

CABLE SIZE		MOLD PART NO.	WELD METAL
Run	Tap		
1/0	2	PCC -2C1V	65
	4	PCC -2C1L	65
	6	PCC -2C1H	45
	6 SOL	PCC -2C1G	45
	8 SOL	PCC -2C1D	45
2/0	2	PCC -2G1V	90
	4	PCC -2G1L	65
	6	PCC -2G1H	65
	6 SOL	PCC -2G1G	65
	8 SOL	PCC -2G1D	65
4/0	1	PCC -2Q1Y	115
	2	PCC -2Q1V	115
	4	PCC -2Q1L	90
	6	PCC -2Q1H	90
	6 SOL	PCC -2Q1G	90
	8 SOL	PCC -2Q1D	90

® Copperweld is a registered trademark of Copperweld Corp.



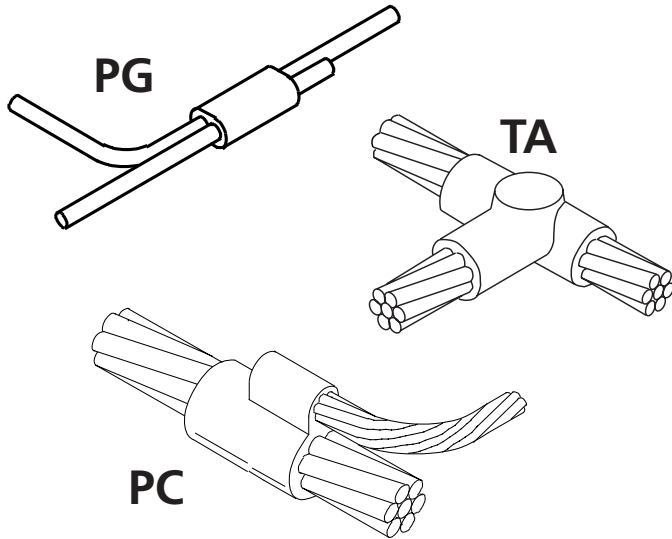

HORIZONTAL TEE CONNECTIONS

- Tee of horizontal run and tap cables.
 - PC and PG make parallel style connections which the user can form into a tee.
 - Concentric stranded copper cable unless otherwise noted.
 - Solid conductor can be either copper or Copperweld.
 - Bold letter in mold part number is the price key.
- Note: For PC, the tap cable is on top.

REQUIRED TOOLS

Handle Clamps L160 for **C** Price Key Molds

L159 for **D** Price Key Molds

Clamps are included with T Price Key Molds

Flint Ignitor T320 (Included with handle clamp or frame but also available separately)

SUGGESTED TOOLS

Cable Cleaning Brush	T313 or T314
Slag Removal Spade	B136A or B136B
Mold Cleaning Brush	T394
Cable Clamp	B265
Torch Head	T111

ACCESSORIES

See Section A

CABLE SIZE		MOLD PART NO.	WELD METAL	
Run	Tap			
6 SOL 6	6 SOL 6	PGT -1G1G PGT -1H1H	25 25	
4	4	TAC -1L1L	32	
	6	PCT -1L1H	32	
	6 SOL	PCT -1L1G	32	
	8	PCT -1L1E	32	
	8 SOL	PCT -1L1D	32	
2 SOL	2	TAC -1T1V	45	
	2 SOL	TAC -1T1T	45	
	4	TAC -1T1L	45	
	6	PCT -1T1H	32	
	6 SOL	PCT -1T1G	32	
	8	PCT -1T1E	32	
	8 SOL	PCT -1T1D	32	
	2	2	TAC -1V1V	45
2 SOL		TAC -1V1T	45	
4		TAC -1V1L	45	
6		PCT -1V1H	32	
6 SOL		PCT -1V1G	32	
8		PCT -1V1E	32	
8 SOL		PCT -1V1D	32	
1		1	TAC -1Y1Y	45
		2	TAC -1Y1V	45
		2 SOL	TAC -1Y1T	45
	4	TAC -1Y1L	45	
	6	PCC -1Y1H	45	
	6 SOL	PCC -1Y1G	45	
	8	PCC -1Y1E	45	

CABLE SIZE		MOLD PART NO.	WELD METAL
Run	Tap		
1/0	8 SOL	PCC -1Y1D	45
	1/0	TAC -2C2C	90
	1	TAC -2C1Y	45
	2	TAC -2C1V	45
	2 SOL	TAC -2C1T	45
	4	TAC -2C1L	45
	6	PCC -2C1H	45
	6 SOL	PCC -2C1G	45
	8	PCC -2C1E	45
	8 SOL	PCC -2C1D	45
2/0	2/0	TAC -2G2G	90
	1/0	TAC -2G2C	90
	1	TAC -2G1Y	45
	2	TAC -2G1V	45
	2 SOL	TAC -2G1T	45
	4	TAC -2G1L	45
	6	PCC -2G1H	65
	6 SOL	PCC -2G1G	65
	8	PCC -2G1E	65
	8 SOL	PCC -2G1D	65

HORIZONTAL TEE

PC/PG/TA

CABLE SIZE		MOLD	WELD
Run	Tap	PART NO.	METAL
3/0	3/0	TAC-2L2L	115
	2/0	TAC-2L2G	90
	1/0	TAC-2L2C	90
	1	TAC-2L1Y	45
	2	TAC-2L1V	45
	2 SOL	TAC-2L1T	45
	4	TAC-2L1L	45
	6	PCC-2L1H	90
	6 SOL	PCC-2L1G	90
	8	PCC-2L1E	90
	8 SOL	PCC-2L1D	90
	4/0	4/0	TAC-2Q2Q
3/0		TAC-2Q2L	115
2/0		TAC-2Q2G	90
1/0		TAC-2Q2C	90
1		TAC-2Q1Y	90
2		TAC-2Q1V	90
2 SOL		TAC-2Q1T	90
4		TAC-2Q1L	90
6		PCC-2Q1H	90
6 SOL		PCC-2Q1G	90
8		PCC-2Q1E	90
8 SOL		PCC-2Q1D	90
250	250	TAC-2V2V	150
	4/0	TAC-2V2Q	150
	3/0	TAC-2V2L	150
	2/0	TAC-2V2G	90
	1/0	TAC-2V2C	90
	1	TAC-2V1Y	90
	2	TAC-2V1V	90
	2 SOL	TAC-2V1T	90
	4	TAC-2V1L	90
	300	300	TAC-3A3A
250		TAC-3A2V	150
4/0		TAC-3A2Q	150
3/0		TAC-3A2L	150
2/0		TAC-3A2G	90
1/0		TAC-3A2C	90
1		TAC-3A1Y	90
2		TAC-3A1V	90
2 SOL		TAC-3A1T	90
4		TAC-3A1L	90

CABLE SIZE		MOLD	WELD	
Run	Tap	PART NO.	METAL	
350	350	TAC-3D3D	200	
	300	TAC-3D3A	200	
	250	TAC-3D2V	200	
	4/0	TAC-3D2Q	150	
	3/0	TAC-3D2L	150	
	2/0	TAC-3D2G	90	
	1/0	TAC-3D2C	90	
	1	TAC-3D1Y	90	
	2	TAC-3D1V	90	
	4	TAC-3D1L	90	
500	500	TAC-3Q3Q	2-150	
	350	TAC-3Q3D	200	
	300	TAC-3Q3A	200	
	250	TAC-3Q2V	200	
	4/0	TAC-3Q2Q	150	
	2/0	TAC-3Q2G	90	
	1/0	TAC-3Q2C	90	
	1	TAC-3Q1Y	90	
	2	TAC-3Q1V	90	
	4	TAC-3Q1L	90	
750	750	TAD-4L4L	500	
	500	TAD-4L3Q	2-200	
	350	TAC-4L3D	250	
	300	TAC-4L3A	200	
	250	TAC-4L2V	200	
	4/0	TAC-4L2Q	150	
	2/0	TAC-4L2G	150	
	1/0	TAC-4L2C	150	
	1000	1000	TAD-4Y4Y	500
		750	TAD-4Y4L	500
500		TAD-4Y3Q	2-200	
350		TAC-4Y3D	250	
300		TAC-4Y3A	200	
250		TAC-4Y2V	200	
4/0		TAC-4Y2Q	150	
2/0		TAC-4Y2G	150	
1/0		TAC-4Y2C	150	



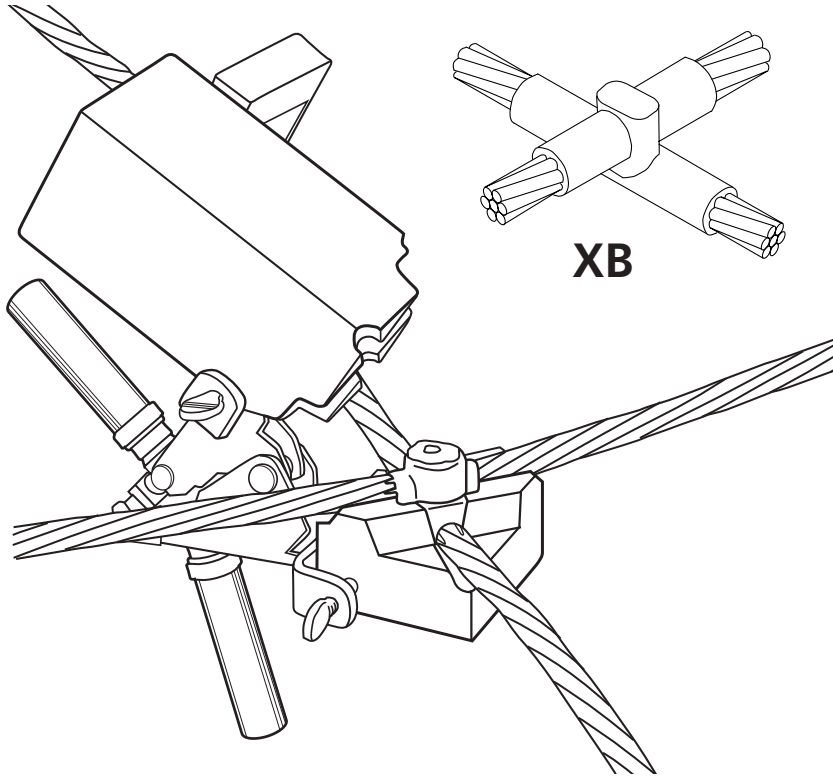

XBQ/XBZ MOLDS

The CADWELD XB molds are the quickest, most efficient way to make lapped, horizontal x-style connections on solid or concentric stranded cable for a variety of installations.

For cable-to-cable X-style connections at power substations and other commercial and industrial sites, there's never been a faster or easier way to make a reliable CADWELD connection. This two-piece mold lets you make connections in a trench in about half the time it would take with compression connectors or other exothermic products — and at a fraction of the cost.

- Ergonomic two-piece molds use standard L160 and L159 handle clamps...the same clamps you use with other CADWELD molds.
- Saves labor costs. X-style connection can be made by one person in about 1 minute. That's 40 to 70% faster than other methods.
- Costs less. Saves you 1/3 over other models, thanks to innovative design techniques and advanced manufacturing technology.
- Simple to use. Operates just like an XA-style mold, but there's no need to cut the cable!
- Easy cable alignment.
- Also available in "smokeless" EXOLON.

NOTES

- Molds not available with wear plates.
- Special cleaning tool supplied with each mold.
- All Q price molds require L160 handle clamp.
- All Z price molds require L159 handle clamp.

COPPER

Cable Size*		Mold Part Number	Weld Metal
Run	Tap		
1/0 SOL	1/0 SOL	XBQ2B2B	150
1/0 Conc.	1/0 Conc.	XBQ2C2C	150
2/0 SOL	2/0 SOL	XBQ2F2F	200
2/0 Conc.	2/0 Conc.	XBQ2G2G	200
3/0 SOL	3/0 SOL	XBQ2K2K	250
3/0 Conc.	3/0 Conc.	XBQ2L2L	250
4/0 SOL	4/0 SOL	XBQ2P2P	250
4/0 Conc.	4/0 Conc.	XBQ2Q2Q	250
250 SOL	250 SOL	XBQ2T2T	2-150
250 Conc.	250 Conc.	XBQ2V2V	2-150
300 Conc.	300 Conc.	XBZ3A3A	2-200
350 Conc.	350 Conc.	XBZ3D3D	500
400 Conc.	400 Conc.	XBZ3H3H	3-200
500 Conc.	500 Conc.	XBZ3Q3Q	3-250

* Consult ERICO for molds to fit other cable sizes or run/tap combinations.

COPPERWELD®

Cable Size*		Mold Part Number	Weld Metal
Run	Tap		
7/#7	7/#7	XBQ9C9C	200
7/#5	7/#5	XBQ9E9E	250
19/#9	19/#9	XBQ9F9F	2-150
19/#8	19/#8	XBZ9G9G	2-200
19/#7	19/#7	XBZ9H9H	500
19/#6	19/#6	XBZ9J9J	3-250

* Consult ERICO for molds to fit other cable sizes or run/tap combinations.

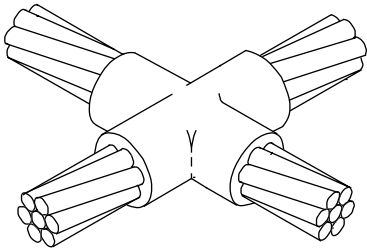

XA

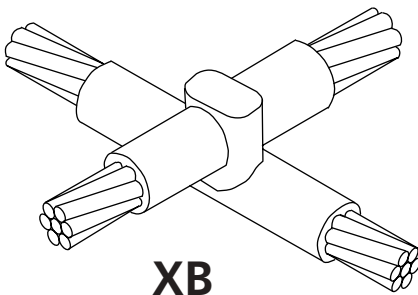

XB

HORIZONTAL X CONNECTIONS

- XA – Cross of horizontal cables, tap cable cut – cables in same plane.
- XB – Cross of horizontal cables, lapped and not cut.
- Concentric stranded copper cable unless otherwise noted.
- Solid conductor may be either copper or Copperweld®.
- **Bold letter** in mold part number is the price key.

REQUIRED TOOLS

Handle Clamps **L160** for **C** Price Key Molds
L159 for **D** Price Key Molds

Clamps are included with M, P and V Price Key Molds

Flint Ignitor **T320** (Included with handle clamp or frame but also available separately)

SUGGESTED TOOLS

Cable Cleaning Brush	T313 or T314
Slag Removal Spade	B136A or B136B
Mold Cleaning Brush	T394
Cable Clamp	B265
Torch Head	T111

ACCESSORIES

See Section A

CABLE SIZE		TYPE XA		TYPE XB	
Run	Tap	MOLD PART NO.	WELD METAL	MOLD PART NO.	WELD METAL
6 SOL 6	6 SOL 6	USE XB	–	XBP-1G1G	32
		USE XB	–	XBP-1H1H	45
4	4	XAC-1L1L	45	XBC-1L1L	65
2	2	XAC-1V1V	65	XBC-1V1V	90
	4	XAC-1V1L	65	XBC-1V1L	65
2 SOL	2 SOL	XAC-1T1T	65	XBC-1T1T	90
1	1	XAC-1Y1Y	65	XBC-1Y1Y	115
	2	XAC-1Y1V	65	XBC-1Y1V	90
	4	XAC-1Y1L	65	XBC-1Y1L	90
1/0	1/0	XAC-2C2C	90	XBM-2C2C	150
	1	XAC-2C1Y	90	XBM-2C1Y	150
	2	XAC-2C1V	90	XBM-2C1V	115
	4	XAC-2C1L	90	XBM-2C1L	115
2/0	2/0	XAC-2G2G	115	XBM-2G2G	200
	1/0	XAC-2G2C	115	XBM-2G2C	200
	1	XAC-2G1Y	115	XBM-2G1Y	150
	2	XAC-2G1V	115	XBM-2G1V	150



CABLE SIZE		TYPE XA		TYPE XB	
Run	Tap	MOLD PART NO.	WELD METAL	MOLD PART NO.	WELD METAL
3/0	3/0	XAC-2L2L	150	XBM-2L2L	250
	2/0	XAC-2L2G	150	XBM-2L2G	200
	1/0	XAC-2L2C	115	XBM-2L2C	200
	1	XAC-2L1Y	115	XBM-2L1Y	150
	2	XAC-2L1V	115	XBM-2L1V	150
4/0	4/0	XAC-2Q2Q	200	XBM-2Q2Q	250
	3/0	XAC-2Q2L	200	XBM-2Q2L	250
	2/0	XAC-2Q2G	150	XBM-2Q2G	200
	1/0	XAC-2Q2C	150	XBM-2Q2C	200
	1	XAC-2Q1Y	115	XBM-2Q1Y	150
	2	XAC-2Q1V	115	XBM-2Q1V	150
250	250	XAC-2V2V	200	XBM-2V2V	2-150
	4/0	XAC-2V2Q	200	XBM-2V2Q	2-150
	3/0	XAC-2V2L	200	XBM-2V2L	2-150
	2/0	XAC-2V2G	150	XBM-2V2G	250
	1/0	XAC-2V2C	150	XBM-2V2C	250
	1	XAC-2V1Y	115	XBM-2V1Y	200
	2	XAC-2V1V	115	XBM-2V1V	150
300	300	XAC-3A3A	250	XBV-3A3A	2-200
	250	XAC-3A2V	250	XBV-3A2V	2-200
	4/0	XAC-3A2Q	200	XBM-3A2Q	2-150
	3/0	XAC-3A2L	200	XBM-3A2L	2-150
	2/0	XAC-3A2G	150	XBM-3A2G	250
	1/0	XAC-3A2C	150	XBM-3A2C	250
	1	XAC-3A1Y	115	XBM-3A1Y	200
	2	XAC-3A1V	115	XBM-3A1V	150
350	350	XAC-3D3D	250	XBV-3D3D	500
	300	XAC-3D3A	250	XBV-3D3A	500
	250	XAC-3D2V	250	XBV-3D2V	500
	4/0	XAC-3D2Q	200	XBV-3D2Q	2-200
	3/0	XAC-3D2L	200	XBV-3D2L	2-200
	2/0	XAC-3D2G	200	XBM-3D2G	2-150
	1/0	XAC-3D2C	200	XBM-3D2C	250
	1	XAC-3D1Y	150	XBM-3D1Y	200
	2	XAC-3D1V	150	XBM-3D1V	200
500	500	XAD-3Q3Q	500	XBV-3Q3Q	3-250
	350	XAD-3Q3D	2-200	XBV-3Q3D	3-200
	300	XAD-3Q3A	2-200	XBV-3Q3A	3-200
	250	XAD-3Q2V	2-150	XBV-3Q2V	500
	4/0	XAD-3Q2Q	2-150	XBV-3Q2Q	500
	3/0	XAD-3Q2L	2-150	XBV-3Q2L	500
	2/0	XAC-3Q2G	250	XBV-3Q2G	2-200
	1/0	XAC-3Q2C	250	XBM-3Q2C	2-150

PG

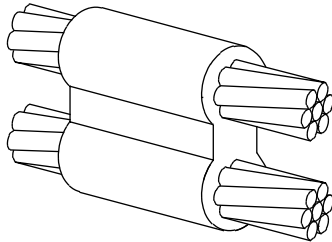
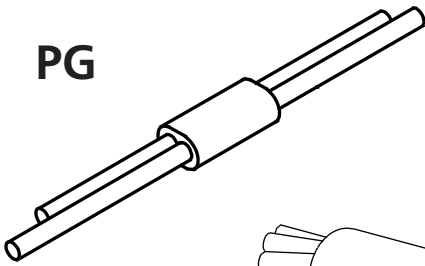

PT

PARALLEL HORIZONTAL CONDUCTORS

- Parallel through connection of horizontal cables.
- Run conductor is on the bottom of Type PT molds.
- Concentric strand copper cable unless otherwise noted.
- Solid conductor may be either copper or Copperweld®.
- **Bold letter** in mold part number is the price key.

REQUIRED TOOLS

Handle Clamps L160 for **C** Price Key Molds

*Clamps are included with **T** Price Key Molds*

Flint Ignitor

T320 (Included with handle clamp or frame but also available separately)

SUGGESTED TOOLS

Cable Cleaning Brush	T313 or T314
Slag Removal Spade	B136A or B136B
Mold Cleaning Brush	T394
Cable Clamp	B265
Torch Head	T111

ACCESSORIES

See Section A

CABLE SIZE		MOLD PART NO.	WELD METAL	
Run	Tap			
6 SOL	6 SOL	PG T -1G1G	25	
6	6	PG T -1H1H	25	
4	4	PT C -1L1L	32	
	6	PT C -1L1H	32	
	6 SOL	PT C -1L1G	32	
	8	PT C -1L1E	32	
	8 SOL	PT C -1L1D	32	
2 SOL	2	PT C -1T1V	65	
	2 SOL	PT C -1T1T	65	
	4	PT C -1T1L	65	
	6	PT C -1T1H	45	
	6 SOL	PT C -1T1G	45	
	8	PT C -1T1E	45	
	8 SOL	PT C -1T1D	45	
	2	2	PT C -1V1V	65
4		PT C -1V1L	65	
6		PT C -1V1H	45	
6 SOL		PT C -1V1G	45	
8		PT C -1V1E	45	
8 SOL		PT C -1V1D	45	
1 SOL		1	PT C -1X1Y	65
		2	PT C -1X1V	65
	2 SOL	PT C -1X1T	65	
	4	PT C -1X1L	65	
	6	PT C -1X1H	65	
	6 SOL	PT C -1X1G	65	
	8	PT C -1X1E	45	
	8 SOL	PT C -1X1D	45	

CABLE SIZE		MOLD PART NO.	WELD METAL
Run	Tap		
1	1	PT C -1Y1Y	65
	1 SOL	PT C -1Y1X	65
	2	PT C -1Y1V	65
	2 SOL	PT C -1Y1T	65
	4	PT C -1Y1L	65
	6	PT C -1Y1H	65
	6 SOL	PT C -1Y1G	65
	8	PT C -1Y1E	45
	8 SOL	PT C -1Y1D	45
	1/0 SOL	1/0	PT C -2B2C
1/0 SOL		PT C -2B2B	90
1		PT C -2B1Y	65
1 SOL		PT C -2B1X	65
2		PT C -2B1V	65
2 SOL		PT C -2B1T	65
4		PT C -2B1L	65
6		PT C -2B1H	65
6 SOL		PT C -2B1G	65
8		PT C -2B1E	65
8 SOL		PT C -2B1D	65



CABLE SIZE		MOLD PART NO.	WELD METAL
Run	Tap		
1/0	1/0	PTC-2C2C	90
	1/0 SOL	PTC-2C2B	90
	1	PTC-2C1Y	65
	1 SOL	PTC-2C1T	65
	2	PTC-2C1V	65
	2 SOL	PTC-2C1T	65
	4	PTC-2C1L	65
	6	PTC-2C1H	65
	6 SOL	PTC-2C1G	65
	8	PTC-2C1E	65
	8 SOL	PTC-2C1D	65
	2/0	2/0	PTC-2G2G
1/0		PTC-2G2C	115
1/0 SOL		PTC-2G2B	115
2		PTC-2G1V	90
1		PTC-2G1Y	90
1 SOL		PTC-2G1X	90
4		PTC-2G1L	90
6		PTC-2G1H	90
6 SOL		PTC-2G1G	90
8		PTC-2G1E	65
8 SOL		PTC-2G1D	65
3/0		3/0	PTC-2L2L
	2/0	PTC-2L2G	150
	1/0	PTC-2L2C	115
	1/0 SOL	PTC-2L2B	115
	2	PTC-2L1V	115
	2 SOL	PTC-2L1T	115
	1 SOL	PTC-2L1X	115
	1	PTC-2L1Y	115
	4	PTC-2L1L	115
	6	PTC-2L1H	90
	6 SOL	PTC-2L1G	90
	8	PTC-2L1E	90
8 SOL	PTC-2L1D	90	

CABLE SIZE		MOLD PART NO.	WELD METAL
Run	Tap		
4/0 SOL	4/0	PTC-2P2Q	200
	4/0 SOL	PTC-2P2P	200
	3/0	PTC-2P2L	200
	2/0	PTC-2P2G	150
	1/0	PTC-2P2C	150
	1/0 SOL	PTC-2P2B	150
	1	PTC-2P1Y	150
	1 SOL	PTC-2P1X	150
	2	PTC-2P1V	150
	2 SOL	PTC-2P1T	150
	4	PTC-2P1L	150
	6	PTC-2P1H	90
4/0	6 SOL	PTC-2P1G	90
	8	PTC-2P1E	90
	8 SOL	PTC-2P1D	90
	4/0	PTC-2Q2Q	200
	4/0 SOL	PTC-2Q2P	200
	3/0	PTC-2Q2L	200
	2/0	PTC-2Q2G	150
	1/0	PTC-2Q2C	150
	1/0 SOL	PTC-2Q2B	150
	1	PTC-2Q1V	150
	1 SOL	PTC-2Q1X	150
	2	PTC-2Q1V	150
2 SOL	PTC-2Q1T	150	
4	PTC-2Q1L	150	
6	PTC-2Q1H	90	
6 SOL	PTC-2Q1G	90	
8	PTC-2Q1E	90	
8 SOL	PTC-2Q1D	90	

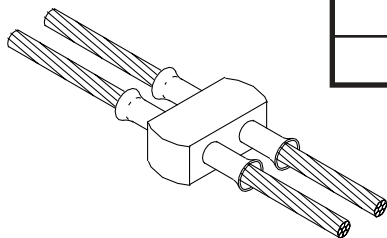

CONDUCTOR SIZE		ONE-SHOT Part No. Parallel Tap
Solid	Stranded	
3, 4	4, 6	PG11L

The CADWELD ONE-SHOT case is a ceramic disposable body replacing the familiar semi-permanent graphite mold and associated handle clamp. Everything required is included except the flint ignitor.

Available in standard packages of 12 each.

NEC Compliant, UL Listed

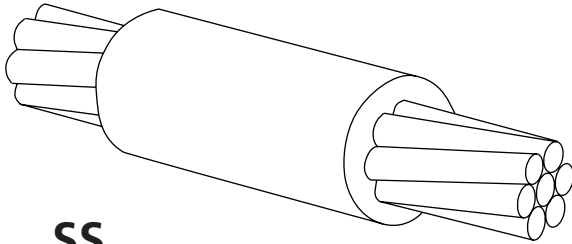

SS

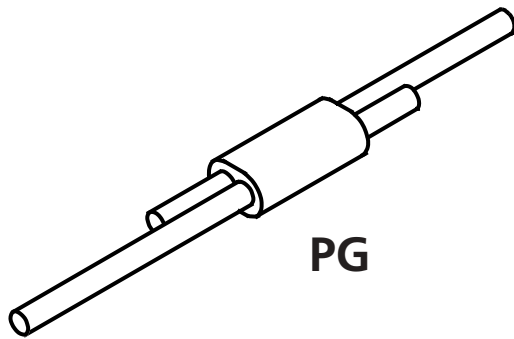

PG

HORIZONTAL SPLICE

- Splice of horizontal cables.
- Type PG makes a parallel style connection.
- Concentric stranded copper cable unless otherwise noted.
- Solid conductor may be either copper or Copperweld®.
- Also available are splices of different and mixed cable sizes. For Copperweld DSA cables, contact ERICO.
- **Bold letter** in mold part number is the price key.

REQUIRED TOOLS

Handle Clamps **L160** for **C** Price Key Molds
L159 for **D** Price Key Molds
Clamps are included with T Price Key Molds

Flint Ignitor **T320** (Included with handle clamp or frame but also available separately)

SUGGESTED TOOLS

Cable Cleaning Brush	T313 or T314
Slag Removal Spade	B136A or B136B
Mold Cleaning Brush	T394
Cable Clamp	B265
Torch Head	T111

ACCESSORIES

See Section A

CABLE SIZE	MOLD PART NO.	WELD METAL
8	PGT-1E1E	15
8 SOL	PGT-1D1D	15
6	PGT-1H1H	25
6 SOL	PGT-1G1G	25
4	SST-1L	25
4 SOL	SST-1K	25
3	SST-1Q	32
2	SST-1V	32
2 SOL	SST-1T	32
1	SST-1Y	32
1 SOL	SST-1X	32
1/0	SSC-2C	45
1/0 SOL	SSC-2B	45
2/0	SSC-2G	65

CABLE SIZE	MOLD PART NO.	WELD METAL
3/0	SSC-2L	90
4/0	SSC-2Q	90
4/0 SOL	SSC-2P	90
250	SSC-2V	115
300	SSC-3A	115
350	SSC-3D	150
500	SSC-3Q	200
750	SSD-4L	2-150
1000	SSD-4Y	2-200



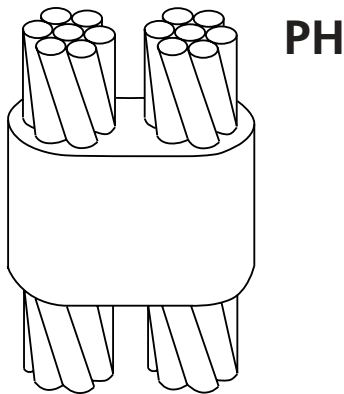

PARALLEL VERTICAL CONDUCTORS

- Parallel through connection of vertical cables.
- Solid conductor may be either copper or Copperweld.
- Concentric stranded copper cable unless otherwise noted.
- **Bold letter** in mold part number is the price key.

REQUIRED TOOLS

Handle Clamps **L160** for *R* Price Key Molds
L159 for *J* Price Key Molds
Frames are included with J, K and T Price Key Molds

Flint Ignitor **T320** (*Included with handle clamp or frame but also available separately*)

SUGGESTED TOOLS

Cable Cleaning Brush	T313 or T314
Slag Removal Spade	B136A or B136B
Mold Cleaning Brush	T394
Cable Clamp	B265
Torch Head	T111

ACCESSORIES

See Section A













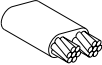
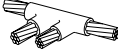

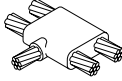

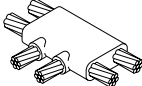

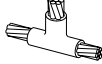



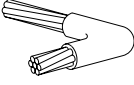

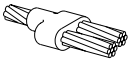

CABLE SIZE		MOLD PART NO.	WELD METAL
Run	Tap		
8 SOL	8 SOL	PHT-1D1D	25
8	8	PHT-1E1E	25
6 SOL	6 SOL	PHR-1G1G	25
6	6	PHR-1H1H	25
4	4	PHR-1L1L	65
	6	PHR-1L1H	90
	6 SOL	PHR-1L1G	45
2 SOL	2 SOL	PHR-1T1T	115
	4	PHR-1T1L	90
2	2	PHR-1V1V	115
	2 SOL	PHR-1V1T	115
	4	PHR-1V1L	90
1	1	PHR-1Y1Y	115
	2	PHR-1Y1V	90
	2 SOL	PHR-1Y1T	90
	4	PHR-1Y1L	90
1/0	1/0	PHR-2C2C	150
	1	PHR-2C1Y	115
	2	PHR-2C1V	115
	2 SOL	PHR-2C1T	115
	4	PHR-2C1L	115

CABLE SIZE		MOLD PART NO.	WELD METAL
Run	Tap		
2/0	2/0	PHR-2G2G	150
	1/0	PHR-2G2C	150
	1	PHR-2G1Y	150
	2	PHR-2G1V	150
	2 SOL	PHR-2G1T	150
	4	PHR-2G1L	115
4/0	4/0	PHJ-2Q2Q	2-200
	2/0	PHR-2Q2G	250
	1/0	PHR-2Q2C	250
	1	PHR-2Q1Y	250
	2	PHR-2Q1V	200
	2 SOL	PHR-2Q1T	200
300	300	PHJ-3A3A	2-200
350	4/0	PHJ-3D2Q	2-200
500	500	PHJ-3Q3Q	3-250
750	750	PHK-4L4L ⁽¹⁾	2-500

⁽¹⁾ Requires M562 Crucible. Order separately.

OTHER CABLE TO CABLE CONNECTIONS

The connections shown below are for use only where connections shown in this catalog are not suitable.

NAME	TYPE		EASE	SPLIT	NAME	TYPE		EASE	SPLIT
Parallel Dead End	PJ		1	V	Tee	TC		3	V
	PK		2	*		TD		3	*
	PM		3	V		TE		3	*
	PN		3	V		TF		3	V
Parallel Tap	PA		2	*	TL		3	V	
	PB		3	V	TV		3	V	
	PD		3	V	X - Vertical Horizontal Cable Uncut	XD		3	V
Splice	PP		1	*	X - Vertical Vertical Cable Uncut	XC		3	V
	PQ		3	V	X - Vertical Neither Cable Uncut	XF		3	*
	PR		2	V	X	XG		3	*
	SC		1	*	Y - 45° tap	YC		3	V
	SD		3	V	Y - 45° tap	YD		3	V
	SE		3	V	Y - 45° tap	YE		3	V
	SV		3	V	Y - 45° tap	YR		3	H



GR
PAGE 2

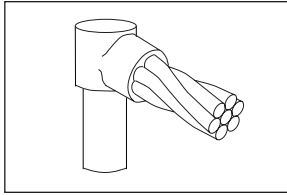

GT
Page 12

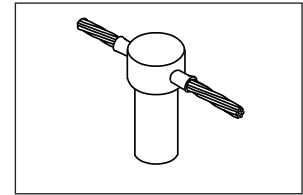

GT
Page 4

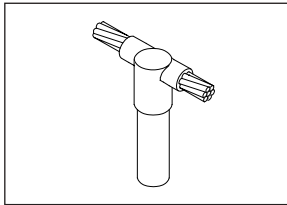

NT
Page 12

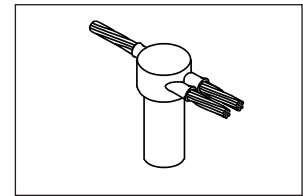

GY
Page 6

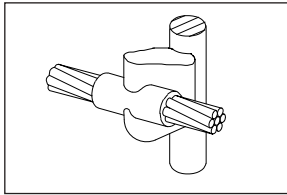

NX
Page 12

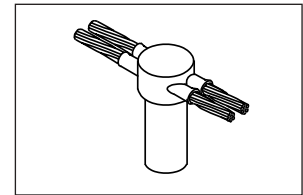

NC
Page 8

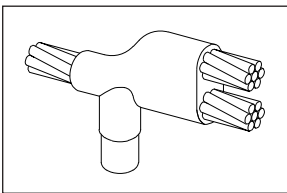

GN Kit
Page 13

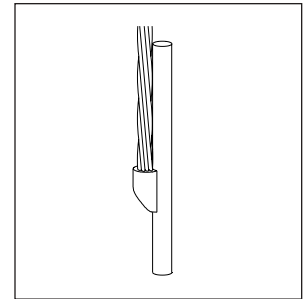

ND
Page 10

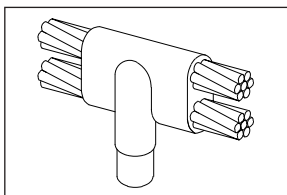

GB
Page 14

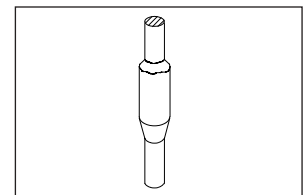

GR
Page 12

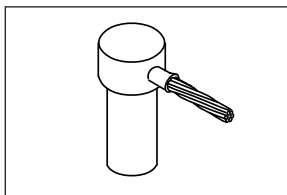

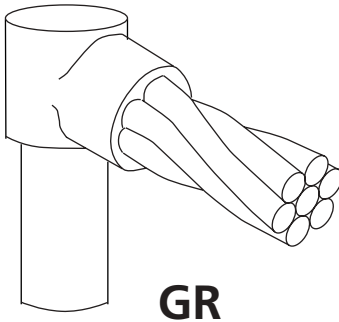

CABLE TO GROUND ROD

- Single cable to top of ground rod. Concentric strand copper cable unless otherwise noted. For copper clad, galvanized, stainless clad or stainless steel ground rods.
- **Bold letter** in mold part number is the price key.

REQUIRED TOOLS

Handle Clamps **L160** for **C** Price Key Molds
Clamps are included with T and P Price Key Molds

Flint Ignitor **T320** (Included with handle clamp or frame but also available separately)

SUGGESTED TOOLS

Cable Cleaning Brush	T313 or T314
Slag Removal Spade	B136A or B136B
Mold Cleaning Brush	T394
File	T329
Cable Clamp	B265
Torch Head	T111

ACCESSORIES

See Section A

GROUND ROD SIZE	CABLE SIZE	MOLD PART NUMBER			WELD METAL
		Steel	Copper Clad Plain (unthreaded)	Copper Clad Sectional (with 9/16" threads)	
1/2"	6	GRT-14C1H	GRT-14A1H	GRT-14B1H	25
	6 SOL	GRT-14C1G	GRT-14A1G	GRT-14B1G	25
	4	GRT-14C1L	GRT-14A1L	GRT-14B1L	25
	4 SOL	GRT-14C1K	GRT-14A1K	GRT-14B1K	25
	2 SOL	GRT-14C1T	GRT-14A1T	GRT-14B1T	32
	2	GRT-14C1V	GRT-14A1V	GRT-14B1V	32

		Steel or Copper Clad Sectional (with 9/16" threads)	Copper Clad Plain (unthreaded)	Copper Clad Sectional (with 1/2" threads)	
1/2"	1	GRC-141Y	GRC-151Y	GRC-131Y	65
	1/0	GRC-142C	GRC-152C	GRC-132C	90
	1/0 SOL	GRC-142B	GRC-152B	GRC-132B	90
	2/0	GRC-142G	GRC-152G	GRC-132G	90
	3/0	GRC-142L	GRC-152L	GRC-132L	90
	4/0	GRC-142Q	GRC-152Q	GRC-132Q	90
	250	GRC-142V	GRC-152V	GRC-132V	90
	300	GRC-143A	GRC-153A	GRC-133A	90



GROUND ROD SIZE	CABLE SIZE	MOLD PART NUMBER		WELD METAL
		Copper Clad Plain (unthreaded)	Steel or Copper Clad Sectional (threaded)	
5/8"	6	GRT-161H	GRT-311H	32
	6 SOL	GRT-161G	GRT-311G	32
	4	GRT-161L	GRT-311L	32
	4 SOL	GRT-161K	GRT-311K	32

		Copper Clad Sectional (threaded) or Plain	Steel	
5/8"	2 SOL	GRC-161T	GRC-311T	65
	2	GRC-161V	GRC-311V	65
	1	GRC-161Y	GRC-311Y	65
	1/0	GRC-162C	GRC-312C	90
	1/0 SOL	GRC-162B	GRC-312B	90
	2/0	GRC-162G	GRC-312G	90
	3/0	GRC-162L	GRC-312L	90
	4/0	GRC-162Q	GRC-312Q	90
	250	GRC-162V	GRC-312V	90
	300	GRC-163A	GRC-313A	115
	350	GRC-163D	GRC-313D	115
	500	GRC-163Q	GRC-313Q	150

		Copper Clad Plain (unthreaded)	Steel or Copper Clad Sectional (threaded)	
3/4"	6	GRT-181H	GRT-331H	32
	6SOL	GRT-181G	GRT-331G	32
	4	GRP-181L	GRP-331L	45
	4 SOL	GRP-181K	GRP-331K	45

		Copper Clad Sectional (threaded) or Plain	Steel	
3/4"	2 SOL	GRC-181T	GRC-331T	90
	2	GRC-181V	GRC-331V	90
	1	GRC-181Y	GRC-331Y	90
	1/0	GRC-182C	GRC-332C	90
	1/0 SOL	GRC-182B	GRC-332B	90
	2/0	GRC-182G	GRC-332G	90
	3/0	GRC-182L	GRC-332L	90
	4/0	GRC-182Q	GRC-332Q	90
	250	GRC-182V	GRC-332V	90
	300	GRC-183A	GRC-333A	115
	350	GRC-183D	GRC-333D	115
	500	GRC-183Q	GRC-333Q	150
	1"		CONTACT ERICO FOR ORDERING INFORMATION	

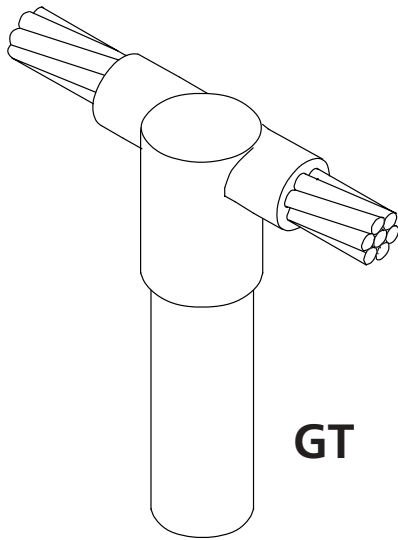

THROUGH CABLE TO GROUND ROD

- Through cable to top of ground rod. Connections are for concentric strand copper cable unless otherwise noted. For copper clad, galvanized, stainless clad or stainless steel ground rods.
- **Bold letter** in mold part number is the price key.

REQUIRED TOOLS

Handle Clamps L160 for *C Price Key* Molds

Clamps are included with T or P Price Key Molds

Flint Ignitor T320 (Included with handle clamp or frame but also available separately)

SUGGESTED TOOLS

Cable Cleaning Brush	T313 or T314
Slag Removal Spade	B136A or B136B
Mold Cleaning Brush	T394
File	T329
Torch Head	T111

ACCESSORIES

See Section A

GROUND ROD SIZE	CABLE SIZE	MOLD PART NUMBER			WELD METAL
		Steel	Copper Clad Plain (unthreaded)	Copper Clad Sectional (with 9/16" threads)	
1/2"	6	G T T-14C1H	G T T-14A1H	G T T-14B1H	32
	6 SOL	G T T-14C1G	G T T-14A1G	G T T-14B1G	32
	4	G T T-14C1L	G T T-14A1L	G T T-14B1L	32
	4 SOL	G T T-14C1K	G T T-14A1K	G T T-14B1K	32

		Steel or Copper Clad Sectional (with 9/16" threads)	Copper Clad Plain (unthreaded)	Copper Clad Sectional (with 1/2" threads)	
		1/2"	2 SOL	G T C-141T	
2	G T C-141V		G T C-151V	G T C-131V	90
1	G T C-141Y		G T C-151Y	G T C-131Y	90
1/0	G T C-142C		G T C-152C	G T C-132C	90
1/0 SOL	G T C-142B		G T C-152B	G T C-132B	90
2/0	G T C-142G		G T C-152G	G T C-132G	90
3/0	G T C-142L		G T C-152L	G T C-132L	115
4/0	G T C-142Q		G T C-152Q	G T C-132Q	115
250	G T C-142V		G T C-152V	G T C-132V	150
300	G T C-143A		G T C-153A	G T C-133A	200



GROUND ROD SIZE	CABLE SIZE	MOLD PART NUMBER		WELD METAL
		Copper Clad Plain (unthreaded)	Steel or Copper Clad Sectional (threaded)	
5/8"	6	GTT-161H	GTT-311H	32
	6 SOL	GTT-161G	GTT-311G	32
	4	GTT-161L	GTT-311L	32
	4 SOL	GTT-161K	GTT-311K	32

		Copper Clad Sectional (threaded) or Plain	Steel	
		5/8"	2 SOL	
	2	GTC-161V	GTC-311V	90
	1	GTC-161Y	GTC-311Y	90
	1/0	GTC-162C	GTC-312C	90
	1/0 SOL	GTC-162B	GTC-312B	115
	2/0	GTC-162G	GTC-312G	115
	3/0	GTC-162L	GTC-312L	115
	4/0	GTC-162Q	GTC-312Q	115
	250	GTC-162V	GTC-312V	150
	300	GTC-163A	GTC-313A	200
	350	GTC-163D	GTC-313D	200
	500	GTC-163Q	GTC-313Q	250

		Copper Clad Plain (unthreaded)	Steel or Copper Clad Sectional (threaded)	
		3/4"	6	
	6 SOL	GTP-181G	GTP-331G	45
	4	GTP-181L	GTP-331L	65
	4 SOL	GTP-181K	GTP-331K	65

		Copper Clad Sectional (threaded) or Plain	Steel	
		3/4"	2 SOL	
	2	GTC-181V	GTC-331V	90
	1	GTC-181Y	GTC-331Y	90
	1/0	GTC-182C	GTC-332C	115
	1/0 SOL	GTC-182B	GTC-332B	115
	2/0	GTC-182G	GTC-332G	115
	3/0	GTC-182L	GTC-332L	115
	4/0	GTC-182Q	GTC-332Q	115
	250	GTC-182V	GTC-332V	150
	300	GTC-183A	GTC-333A	200
	350	GTC-183D	GTC-333D	200
	500	GTC-183Q	GTC-333Q	250
1"	CONTACT ERICO FOR ORDERING INFORMATION			

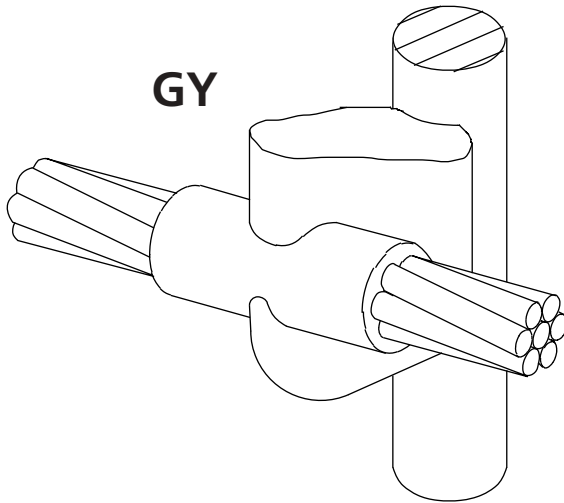

CABLE TO GROUND ROD

- Through cable to side of ground rod.
- Concentric strand copper cable unless otherwise noted.
- Ground rods can be copper clad, galvanized, stainless clad or stainless steel.
- **Bold letter** in mold part number is the price key.

REQUIRED TOOLS

Handle Clamps **L160** for *E* Price Key Molds
L159 for *J* Price Key Molds

*Frames included with E and J Price Key Molds.
B399ES Frame required with P Price Key Molds*

Flint Ignitor **T320** (Included with handle clamp or frame but also available separately)

SUGGESTED TOOLS

Cable Cleaning Brush	T313 or T314
Slag Removal Spade	B136A or B136B
Mold Cleaning Brush	T394
File	T329
Cable Clamp	B265
Torch Head	T111

ACCESSORIES

See Section A

NOTE:

All "P" priced GY molds require B399ES frame. (Sold separately.)

GROUND ROD SIZE	CABLE SIZE	MOLD PART NUMBER			WELD METAL
		Steel or Copper Clad Sectional (with 9/16" threads)	Copper Clad Plain (unthreaded)	Copper Clad Sectional (with 1/2" threads)	
1/2"	4 Str or Sol	GYP-14001M	GYP-15001M	GYP-13001M	65
	2 Str or Sol	GYP-14002M	GYP-15002M	GYP-13002M	65
	1 Str or Sol	GYP-14003M	GYP-15003M	GYP-13003M	65
	1/0	GYE-142C	GYE-152C	GYE-132C	115
	1/0 SOL	GYE-142B	GYE-152B	GYE-132B	115
	2/0	GYE-142G	GYE-152G	GYE-132G	115
	3/0	GYE-142L	GYE-152L	GYE-132L	150
	4/0	GYE-142Q	GYE-152Q	GYE-132Q	150
	250	GYE-142V	GYE-152V	GYE-132V	150
	300	GYE-143A	GYE-153A	GYE-133A	200

NOTE:

All "P" priced GY molds require B399ES frame. (Sold separately.)

GROUND ROD SIZE	CABLE SIZE	MOLD PART NUMBER		WELD METAL
		Copper Clad Sectional (threaded)	Steel	
5/8"	4 Str or Sol	GYP-16005M	GYP-31004M	65
	2 Str or Sol	GYP-16006M	GYP-31003M	65
	1 Str or Sol	GYP-16007M	GYP-31001M	65
	1/0	GYE-162C	GYE-312C	115
	1/0 SOL	GYE-162B	GYE-321B	115
	2/0	GYE-162G	GYE-312G	115
	3/0	GYE-162L	GYE-312L	150
	4/0	GYE-162Q	GYE-312Q	150
	250	GYE-162V	GYE-312V	150
	300	GYE-163A	GYE-313A	200
	350	GYE-163D	GYE-313D	250
	500	GYJ-163Q	GYJ-313Q	2-200
	3/4"	4 Str or Sol	GYP-18010M	GYP-33011M
2 Str or Sol		GYP-18009M	GYP-33010M	65
1 Str or Sol		GYP-18007M	GYP-33008M	65
1/0		GYE-182C	GYE-332C	115
1/0 SOL		GYE-182B	GYE-332B	115
2/0		GYE-182G	GYE-332G	115
3/0		GYE-182L	GYE-332L	150
4/0		GYE-182Q	GYE-332Q	150
250		GYE-182V	GYE-332V	200
300		GYE-183A	GYE-333A	250
350		GYJ-183D	GYJ-333D	2-150
500		GYJ-183Q	GYJ-333Q	500
1"		CONTACT ERICO FOR ORDERING INFORMATION		

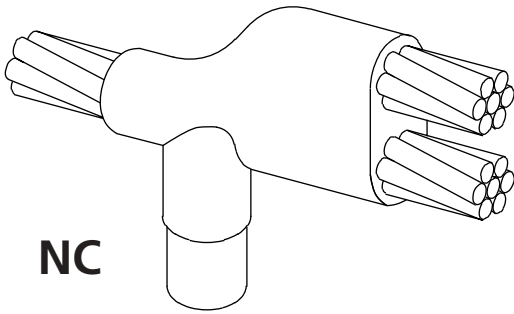

TWO CABLES TO GROUND ROD

- Through cable plus tap cable to top of ground rod.
- Concentric stranded copper cables.
- For copper clad, galvanized, stainless clad, or stainless steel ground rods.
- **Bold letter** in mold part number is the price key.

REQUIRED TOOLS

Handle Clamps **L160** for R Price Key Molds

L159 for F Price Key Molds

Flint Ignitor **T320** (Included with Handle Clamp but also available separately)

SUGGESTED TOOLS

Cable Cleaning Brush	T313 or T314
Slag Removal Spade	B136B
Mold Cleaning Brush	T394
File	T329
Torch Head	T111

ACCESSORIES

See Section A

GROUND ROD SIZE	CABLE SIZE	MOLD PART NUMBER			WELD METAL
		Steel or Copper Clad Sectional (with 9/16" threads)	Copper Clad Plain (unthreaded)	Copper Clad Sectional (with 1/2" threads)	
1/2"	4	NCR -141L	NCR -151L	NCR -131L	90
	2	NCR -141V	NCR -151V	NCR -131V	90
	1	NCR -141Y	NCR -151Y	NCR -131Y	90
	1/0	NCR -142C	NCR -152C	NCR -132	115
	2/0	NCR -142G	NCR -152G	NCR -132G	150
	3/0	NCR -142L	NCR -152L	NCR -132L	200
	4/0	NCR -142Q	NCR -152Q	NCR -132Q	200

GROUND ROD SIZE	CABLE SIZE	MOLD PART NUMBER		WELD METAL
		Copper Clad Sectional (threaded) or Plain	Steel	
5/8"	4	NCR-161L	NCR-311L	90
	2	NCR-161V	NCR-311V	115
	1	NCR-161Y	NCR-311Y	115
	1/0	NCR-162C	NCR-312C	150
	2/0	NCR-162G	NCR-312G	200
	3/0	NCR-162L	NCR-312L	250
	4/0	NCR-162Q	NCR-312Q	250
3/4"	250	NCF-162V	NCF-312V	2-150
	4	NCR-181L	NCR-331L	90
	2	NCR-181V	NCR-331V	115
	1	NCR-181Y	NCR-331Y	115
	1/0	NCR-182C	NCR-332C	150
	2/0	NCR-182G	NCR-332G	200
	3/0	NCR-182L	NCR-332L	250
	4/0	NCR-182Q	NCR-332Q	250
	250	NCF-182V	NCF-332V	2-150
	300	NCF-183A	NCF-333A	2-200
350	NCF-183D	NCF-333D	2-200	
500	NCF-183Q	NCF-333Q	3-200	
1"	4	NCR-221L	NCR-371L	115
	2	NCR-221V	NCR-371V	150
	1	NCR-221Y	NCR-371Y	150
	1/0	NCR-222C	NCR-372C	200
	2/0	NCR-222G	NCR-372G	250
	3/0	NCF-222L	NCF-372L	2-150
	4/0	NCF-222Q	NCF-372Q	2-150
	250	NCF-222V	NCF-372V	2-200
	300	NCF-223A	NCF-373A	500
	350	NCF-223D	NCF-373D	500
350	NCF-223Q	NCF-373D	3-250	

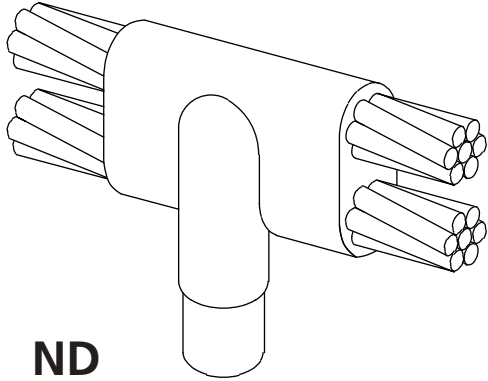

PARALLEL CABLES TO TOP OF GROUND ROD

- Two through cables to top of ground rod. Cables can be bent to form a "T" or "X".
- Concentric strand copper cables listed.
- For copper clad, galvanized, stainless clad or stainless steel ground rods.
- **Bold letter** in mold part number is the price key.

REQUIRED TOOLS

Handle Clamps **L160** for R Price Key Molds

L159 for F Price Key Molds

Flint Ignitor **T320** (Included with handle clamp but also available separately)

SUGGESTED TOOLS

Cable Cleaning Brush	T313 or T314
Slag Removal Spade	B136A or B136B
Mold Cleaning Brush	T394
File	T329
Torch Head	T111

ACCESSORIES

See Section A

GROUND ROD SIZE	CABLE SIZE	MOLD PART NUMBER			WELD METAL
		Steel or Copper Clad Sectional (with 9/16" threads)	Copper Clad Plain (unthreaded)	Copper Clad Sectional (with 1/2" threads)	
1/2"	4	NDR -141L	NDR -151L	NDR -131L	115
	2	NDR -141V	NDR -151V	NDR -131V	115
	1	NDR -141Y	NDR -151Y	NDR -131Y	115
	1/0	NDR -142C	NDR -152C	NDR -132C	150
	2/0	NDR -142G	NDR -152G	NDR -132G	200
	3/0	NDR -142L	NDR -152L	NDR -132L	250
	4/0	NDR -142Q	NDR -152Q	NDR -132Q	250

GROUND ROD SIZE	CABLE SIZE	MOLD PART NUMBER		WELD METAL
		Copper Clad Sectional (threaded) or Plain	Steel	
5/8"	4	NDR-161L	NDR-311L	115
	2	NDR-161V	NDR-311V	150
	1	NDR-161Y	NDR-311Y	150
	1/0	NDR-162C	NDR-312C	200
	2/0	NDR-162G	NDR-312G	250
	3/0	NDF-162L	NDF-312L	2-150
	4/0	NDF-162Q	NDF-312Q	2-150
	250	NDF-162V	NDF-312V	2-200
	300	NDF-163A	NDF-313A	500
	350	NDF-163D	NDF-313D	500
	500	NDF-163Q	NDF-313Q	3-250
	3/4"	4	NDR-181L	NDR-331L
2		NDR-181V	NDR-331V	150
1		NDR-181Y	NDR-331Y	150
1/0		NDR-182C	NDR-332C	200
2/0		NDR-182G	NDR-332G	250
3/0		NDF-182L	NDF-332L	2-150
4/0		NDF-182Q	NDF-332Q	2-150
250		NDF-182V	NDF-332V	2-200
300		NDF-183A	NDF-333A	500
350		NDF-183D	NDF-333D	500
500		NDF-183Q	NDF-333Q	3-250
1"		4	NDR-221L	NDR-371L
	2	NDR-221V	NDR-371V	200
	1	NDR-221Y	NDR-371Y	200
	1/0	NDR-222C	NDR-372C	250
	2/0	NDF-222G	NDF-372G	2-150
	3/0	NDF-222L	NDF-372L	2-200
	4/0	NDF-222Q	NDF-372Q	2-200
	250	NDF-222V	NDF-372V	500
	300	NDF-223A	NDF-373A	3-200
	350	NDF-223D	NDF-373D	3-200

ONE-SHOT CABLE TO GROUND ROD

GR/GT/NT/NX

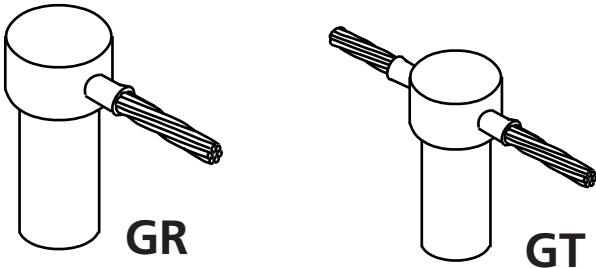

CABLE TO GROUND ROD USING CADWELD ONE-SHOT CONNECTIONS

For plain or threaded copper clad and galvanized steel or stainless steel rods. The CADWELD ONE-SHOT case is a ceramic disposable body replacing the familiar semi-permanent graphite mold and associated Handle Clamp. Everything required is included except the flint ignitor.

R.E.A. Accepted
NEC Approved

REQUIRED TOOLS

Flint Ignitor T320

SUGGESTED TOOLS

Cable Cleaning Brush T313 or T314
File T329
Torch Head T111

ACCESSORIES

See Section A

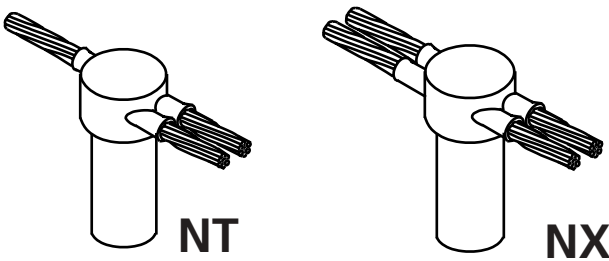

ONE-SHOT connections are available
in standard packages of 12 each.



GROUND ROD SIZE	CONDUCTOR		CONNECTOR PART NUMBER			
	Solid	Stranded	TYPE GR	TYPE GT	TYPE NT	TYPE NX
1/2"	6,8	8	GR1-141G	GT1-141G	NT1-141G	NX1-141G
	3,4	4,6	GR1-141L	GT1-141L	NT1-141L	NX1-141L
	1,2	2,3	GR1-141V	GT1-141V	NT1-141V	—
5/8"	6,8	8	GR1-161G	GT1-161G	NT1-161G	NX1-161G
	3,4	4,6	GR1-161L	GT1-161L	NT1-161L	NX1-161L
	1,2	2,3	GR1-161V	GT1-161V	NT1-161V	NX1-161V
	2/0, 1/0	1/0, 1	GR1-162C	GT1-162C	—	—
			GR1-162G	GT1-162G	—	—
			GR1-162Q	—	—	—
			2/0	—	—	—
4/0	—	—	—			
3/4"	6,8	8	GR1-181G	GT1-181G	NT1-181G	NX1-181G
	3,4	4,6	GR1-181L	GT1-181L	NT1-181L	NX1-181L
	1,2	2,3	GR1-181V	GT1-181V	NT1-181V	NX1-181V
	2/0, 1/0	1/0, 1	GR1-182C	GT1-182C	—	—
			GR1-182G	GT1-182G	—	—
			GR1-182Q	—	—	—
			2/0	—	—	—
4/0	—	—	—			



The Unbeatable CADWELD Connection Alternative To "Acorn" Mechanical Connections

Whether you're working in telecommunications, electric distribution or cable television, here's everything you need to make a permanent and reliable wire-to-ground rod connection at the lowest cost and with maximum convenience. The **CADWELD GN** Connection Kit contains all materials

and necessary tools to make sixty CADWELD connections quickly, easily and inexpensively. With replacement mold and weld-metal kits, you can make hundreds more.

GN Connection Kit #	Application	Description
K220	#6 SOL to 1/2" copper-bonded ground rod	Starter kit *
K220R	#6 SOL to 1/2" copper-bonded ground rod	Replacement kit with Mold (GNT141G001M) and sixty #25 weld metal
K217	#6 SOL to 5/8" copper-bonded ground rod	Starter kit *
K217R	#6 SOL to 5/8" copper-bonded ground rod	Replacement kit with Mold (GNT161G001M) and sixty #25 weld metal
K222	#6 SOL to 3/4" copper-bonded ground rod	Starter kit *
K222R	#6 SOL to 3/4" copper-bonded ground rod	Replacement kit with Mold (GNT181G001M) and sixty #25 weld metal
K221	#4 SOL to 1/2" copper-bonded ground rod	Starter kit *
K221R	#4 SOL to 1/2" copper-bonded ground rod	Replacement kit with Mold (GNT141K001M) and sixty #25 weld metal
K218	#4 SOL to 5/8" copper-bonded ground rod	Starter kit *
K218R	#4 SOL to 5/8" copper-bonded ground rod	Replacement kit with Mold (GNT161K001M) and sixty #25 weld metal
K223	#4 SOL to 3/4" copper-bonded ground rod	Starter kit *
K223R	#4 SOL to 3/4" copper-bonded ground rod	Replacement kit with Mold (GNT181K001M) and sixty #25 weld metal

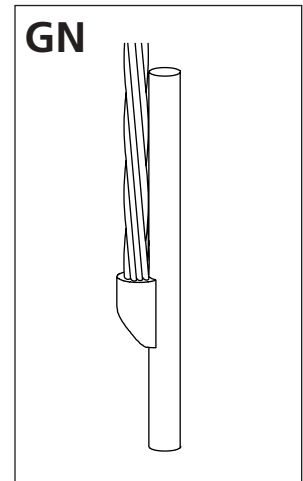

The **GN Connection Kit** can be specified for connecting #6 or #4 solid copper ground wire to 1/2", 5/8" or 3/4" ground rods.

*The **Starter Kit** includes mold, handle clamp, weld metal, flint ignitor and cleaning supplies in a carrying case.



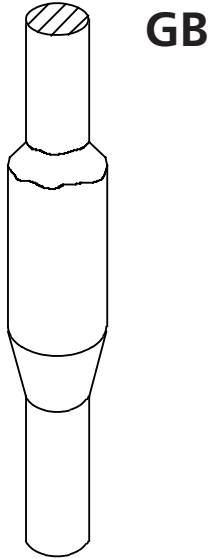

GROUND ROD SPLICE

- CADWELD ground rod splices are very strong and use the proven corrosion resistant CADWELD connection.
- CADWELD ground rod splices are available for copper clad, galvanized, stainless or stainless clad ground rods.
- **Bold** letter in mold part number is the price key.

REQUIRED TOOLS

Handle Clamps **L160** for **C** Price Key Molds
L159 for **D** and **F** Price Key Molds.

Flint Ignitor **T320** (Included with handle clamp but also available separately)

Ground Rod Splice Clamp **B120**

SUGGESTED TOOLS

Cable Cleaning Brush	T313 or T314
Slag Removal Spade	B136A or B136B
Mold Cleaning Brush	T394
File	T329
Torch Head	T111

ACCESSORIES







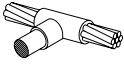
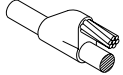
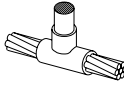
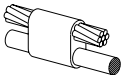
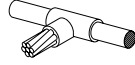

See Section A

GROUND ROD SIZE	GROUND ROD TYPE	MOLD PART NO.	WELD METAL
1/2"	Steel or Copper clad sectional (9/16" threads)	HDGBC-14	250
	Copper clad plain (unthreaded)	HDGBC-15	250
	Copper clad sectional (with 1/2" threads)	HDGBC-13	250
5/8"	Copper clad; 0.563" diameter Fits both plain and sectional (threaded) rods	HDGBD-16	2-150
	0.625" diameter Stainless, stainless clad, galvanized, etc.	HDGBD-31	2-150
3/4"	Copper clad; 0.682" diameter Fits both plain and sectional (threaded) rods	HDGBD-18	2-200
	0.750" diameter Stainless, stainless clad, galvanized, etc.	HDGBD-33	2-200
1"	Copper clad; 0.914" diameter Fits both plain and sectional (threaded) rods	HDGBF-22	3-250
	1.000" diameter Stainless, stainless clad, galvanized, etc.	HDGBF-37	3-250

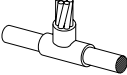

OTHER CABLE TO GROUND ROD CONNECTIONS

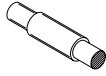
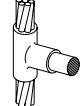
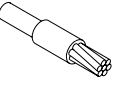
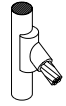
The connections shown below are for use only where connections shown in this catalog are not suitable.

NAME	TYPE		EASE	SPLIT	NAME	TYPE		EASE	SPLIT	
Parallel Tap	GQ		3	V	Tee	GG		1	*	
	GS		1	V		GH		3	V	
Parallel Thru	DQ		1	V		GJ		1	*	
	GP		3	V		GK		3	V	
	GW		1	V		GM		2	V	
Splice	GD		3	V		GN		2	V	
	GE		1	V		GX		3	V	
	GF		1	V		Y - 45° Tap	VW		2	V
	GV		1	V						

NOTES...



HA
Page 2

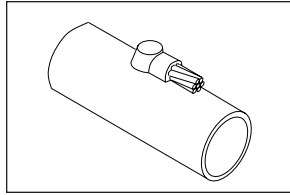

VS
Page 7

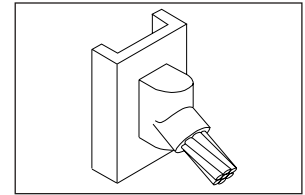

HB
Page 3

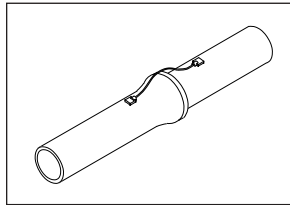

VS
Page 8

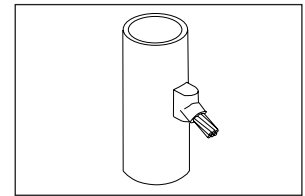

VN
Page 4

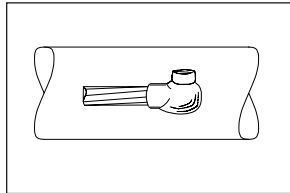

VF
Page 9

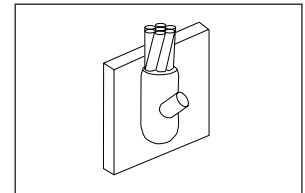

HA
Page 5

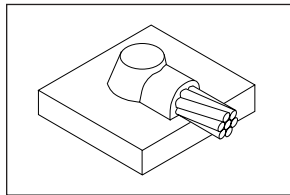

VB
Page 9

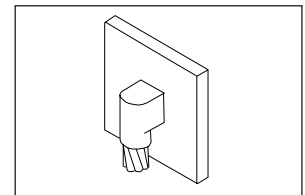

HS
Page 5

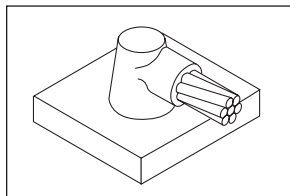

VG
Page 10

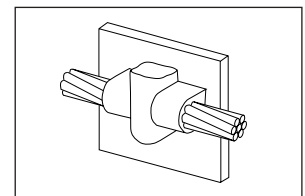

HC
Page 6

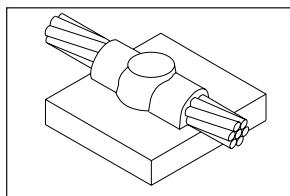

VT
Page 10

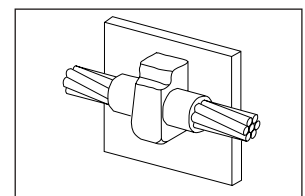

HT
Page 6

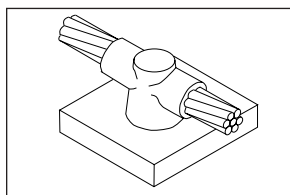

VV
Page 11

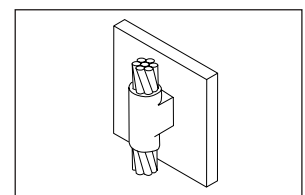

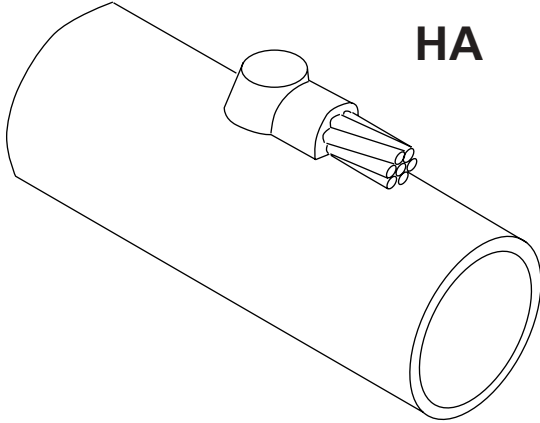

HA - Cable to Horizontal Steel Pipe

RANGE OF HORIZONTAL STEEL PIPES

- Horizontal copper conductor to top of horizontal steel pipe.
- CADWELD also has a complete product line for cathodic protection connections. See Bulletin CA1A.
- **A test weld should be made to check the possibility of burn through on thin sections or thin wall pipe.**
- When only one pipe size is involved, see Cable to Steel Pipe table on previous page.
- Concentric stranded copper cable listed.
- **Bold letter** in mold part number is the price key.

REQUIRED TOOLS

Handles

Handle is included with **A** and **H**
Price Key **Molds**

Flint Ignitor

T320 (Included with handle clamp but also available separately)

SUGGESTED TOOLS

Cable Cleaning Brush	T313 or T314
Slag Removal Spade	B136A or B136B
Mold Cleaning Brush	T394
Rasp	T321
Torch Head	T111

ACCESSORIES

See Section A

CABLE SIZE	Nominal Pipe Size	MOLD PART NO.	WELD METAL
4	1 1/4" to 2" Pipe	HAA-1L-162C	45
	3" to 4" Pipe	HAA-1L-350C	45
	6" to 8" Pipe	HAA-1L-7C	45
	10" to 12" Pipe	HAA-1L-11C	45
	14" Pipe or Larger	(1)	
2	1 1/4" to 2" Pipe	HAA-1V-162C	45
	3" to 4" Pipe	HAA-1V-350C	45
	6" to 8" Pipe	HAA-1V-7C	45
	10" to 12" Pipe	HAA-1V-11C	45
	14" Pipe or Larger	(1)	
2 SOL	1 1/4" to 2" Pipe	HAA-1T-162C	45
	3" to 4" Pipe	HAA-1T-350C	45
	6" to 8" Pipe	HAA-1T-7C	45
	10" to 12" Pipe	HAA-1T-11C	45
	14" Pipe or Larger	(1)	
1	2 1/2" to 4" Pipe	HAA-1Y-325C	65
	6" to 8" Pipe	HAA-1Y-7C	65
	10" to 12" Pipe	HAA-1Y-11C	65
	14" Pipe or Larger	(1)	

(1) Use flat surface mold part number. See page 3-5.

CABLE SIZE	Nominal Pipe Size	MOLD PART NO.	WELD METAL
1/0	3" to 4" Pipe	HAH-2C-350C	90
	6" to 10" Pipe	HAH-2C-8C	90
	12" to 28" Pipe	HAH-2C-20C	90
	30" Pipe or Larger	(1)	
2/0	3" to 4" Pipe	HAH-2G-350C	90
	6" to 10" Pipe	HAH-2G-8C	90
	12" to 28" Pipe	HAH-2G-20C	90
	30" Pipe or Larger	(1)	
3/0	3" to 4" Pipe	HAH-2L-350C	115
	6" to 10" Pipe	HAH-2L-8C	115
	12" to 28" Pipe	HAH-2L-20C	115
	30" Pipe or Larger	(1)	
4/0	3" to 4" Pipe	HAH-2Q-350C	115
	6" to 10" Pipe	HAH-2Q-8C	115
	12" to 28" Pipe	HAH-2Q-20C	115
	30" Pipe or Larger	(1)	

(1) Use flat surface mold part number. See page 3-5.



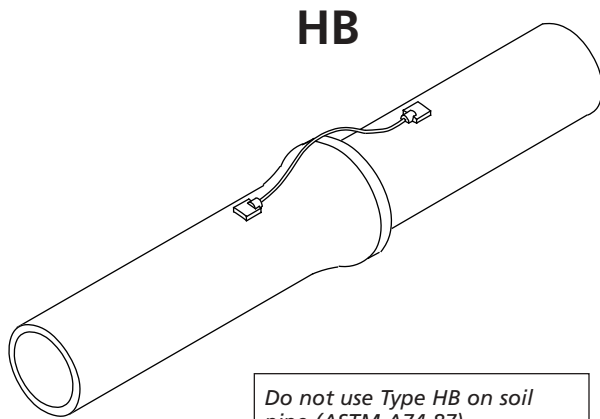

Do not use Type HB on soil pipe (ASTM A74-87)

Note: DUCTILE IRON

Tests by ERICO indicate that connections to most ductile iron pipe can be made using the CADWELD molds and weld metal designated to be used on steel pipe.

However, some reports from the field suggest that all ductile iron is not the same. In such cases, the molds and weld material for cast iron do work.

We therefore suggest:

1. Whenever possible, make tests on the ductile iron pipe being used to determine if the material for steel can be used.

– OR –

2. Use the molds and weld metal designed for cast iron. It will make satisfactory connections on all ductile iron.

HORIZONTAL CAST IRON SURFACE

- **NOT FOR USE ON STEEL PIPE**
- CADWELD cable connections to horizontal flat cast iron surface; cable to top of horizontal cast iron pipe.
- **A test weld should be made on a section of the pipe being used to determine possibility of detrimental metallurgical effects.**
- Concentric stranded copper cable unless otherwise noted.
- **Bold letter** in mold part number is the price key.

REQUIRED TOOLS

- Handles** Handle is included with **A Price Key Molds**
- Flint Ignitor** **T320** (Included with handle clamp but also available separately)

SUGGESTED TOOLS

- Cable Cleaning Brush T313 or T314
 Rasp T321
 Slag Removal Spade B136A or B136B
 Mold Cleaning Brush T394
 Torch Head T111

ACCESSORIES

See Section A

CONDUCTOR SIZE	SURFACE	Mold Part No.	WELD METAL
8 Solid or Stranded, 6 Solid	Flat 4" to 24" Pipe	HBA-1G	25XF-19
		HBA-1G-P.S.*	25XF-19
6 Stranded	Flat 4" to 24" Pipe	HBA-1H	25XF-19
		HBA-1H-P.S.*	25XF-19
4 Solid	Flat 4" to 24" Pipe	HBA-1K	45XF-19
		HBA-1K-P.S.*	45XF-19
4 Stranded	Flat 4" to 24" Pipe	HBA-1L	45XF-19
		HBA-1L-P.S.*	45XF-19
2 Solid	Flat 4" to 24" Pipe	HBA-1T	45XF-19
		HBA-1T-P.S.*	45XF-19
2 Stranded	Flat 4" to 24" Pipe	HBA-1V	45XF-19
		HBA-1V-P.S.*	45XF-19
1 Stranded	Flat 4" to 24" Pipe	HBA-1Y	65XF-19
		HBA-1Y-P.S.*	65XF-19

*Specify nominal pipe size, i.e., HBA1G-6 for 6" pipe.

Use flat surface mold part number for pipes larger than 24 inches.

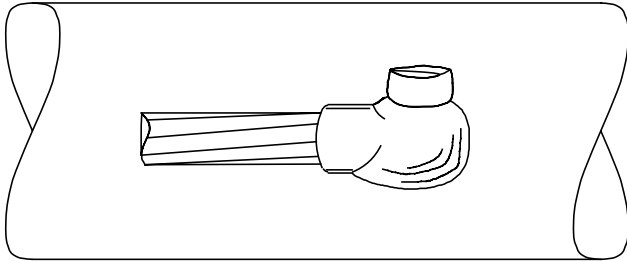

VN

Right hand shown - RH

VERTICAL STEEL SURFACE

- Conductor to vertical flat steel surface or cable to the side of horizontal steel pipe.
- Concentric stranded copper cable is listed.
- **A test weld should be made to check the possibility of burn through on thin sections or thin wall pipe.**
- Cable to vertical side of horizontal steel pipe. Add right or left hand and nominal pipe size to flat surface mold part number.
Example: VNC-2G-LH-4 - weld on left end of conductor, 4" pipe, 2/0 stranded conductor.
- **Bold letter** in mold part number is the price key.

REQUIRED TOOLS

Handle Clamps L160 for C Price Key Molds

Flint Ignitor T320 (Included with handle clamp but also available separately)

SUGGESTED TOOLS

Cable Cleaning Brush	T313 or T314
Slag Removal Spade	B136A or B136B
Mold Cleaning Brush	T394
Rasp	T321
Torch Head	T111

ACCESSORIES

See Section A

TYPE VN		
CABLE SIZE	MOLD PART NO.	WELD METAL
6*	VNC-1H	45
4	VNC-1L	45
2 SOL	VNC-1T	65
2	VNC-1V	45
1	VNC-1Y	65
1/0	VNC-2C	90
2/0	VNC-2G	90
3/0	VNC-2L	115
4/0	VNC-2Q	115
250	VNC-2V	115
300	VNC-3A	150
350	VNC-3D	200
500	VNC-3Q	200

*Requires B112 sleeve (1 per weld)



HA

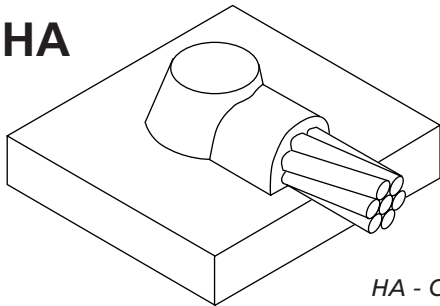

HA - Cable on surface

HS

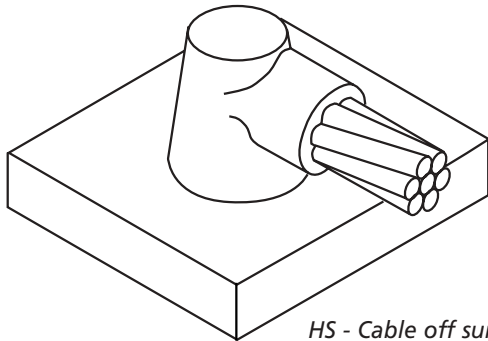

HS - Cable off surface

TYPE HA

CABLE SIZE	MOLD PART NO.	WELD METAL
6*	HAA-1H	45
4	HAA-1L	45
2 SOL	HAA-1T	45
2	HAA-1V	45
1	HAA-1Y	65

TYPE HS

CABLE SIZE	MOLD PART NO.	WELD METAL
1/0	HSC-2C	90
2/0	HSC-2G	90
3/0	HSC-2L	115
4/0	HSC-2Q	115
250	HSC-2V	115
300	HSC-3A	150
350	HSC-3D	200
500	HSC-3Q	200
750	HSD-4L	2-150
1000	HSD-4Y	2-200

*Requires B112 sleeve (1 per weld)

HORIZONTAL STEEL SURFACE

- Horizontal concentric copper conductor to flat steel surface or top of horizontal pipe
- CADWELD also has a complete product line for cathodic protection connections. See Bulletin CA1A.
- **A test weld should be made to check the possibility of burn through on thin sections or thin wall pipe.**
- Concentric stranded copper cable listed.
- **Bold letter** in mold part number is the price key.

REQUIRED TOOLS

- Handle Clamps** **L160** for **C** Price Key Molds
L159 for **D** Price Key Molds
Handles are included with A Price Key Molds
- Flint Ignitor** **T320** (Included with handle clamp or frame but also available separately)

SUGGESTED TOOLS

- | | |
|----------------------|----------------|
| Cable Cleaning Brush | T313 or T314 |
| Slag Removal Spade | B136A or B136B |
| Mold Cleaning Brush | T394 |
| Cable Clamp | B265 |
| Torch Head | T111 |

ACCESSORIES

See Section A

Cable to Steel Pipe (Types **HA** and **HS**) –
 Use flat surface mold part number with suffix.

Cable	Nominal Pipe Size	Suffix
#1 and Smaller	12" and smaller	Nominal Pipe Size
	14" and larger	None
1/0 thru 250	28" and smaller	Nominal Pipe Size
	30" and larger	None

Example: #1 cable to 3-1/2" pipe, HAA-1Y-3.50

For welds to copper surface, see section 5

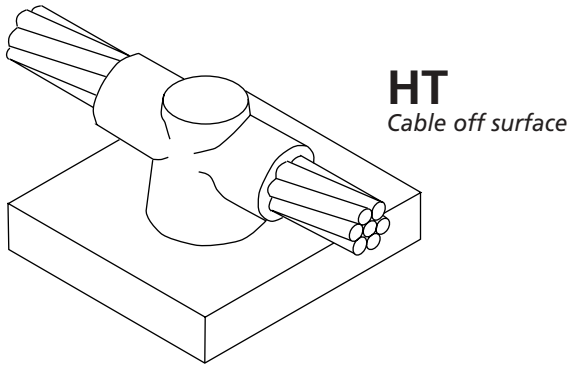
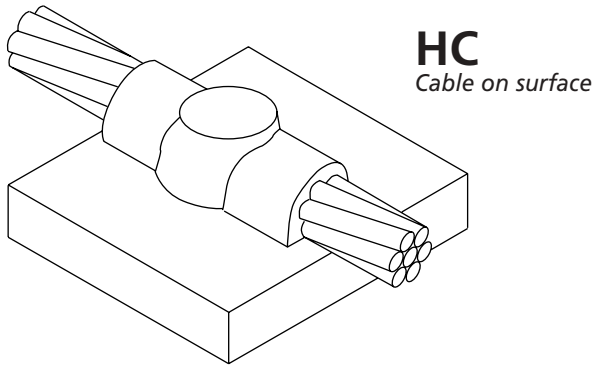

HORIZONTAL STEEL SURFACE

- Cable to horizontal flat steel surface or cable to top of horizontal steel pipe.
- CADWELD also has a complete product line for cathodic protection connections. See Bulletin CA1A.
- Concentric stranded copper cable listed.
- **A test weld should be made to check the possibility of burn through on thin sections or thin wall pipe.**
- **Bold letter** in mold part number is the price key.

REQUIRED TOOLS

- Handle Clamps** **L160** for **C** Price Key Molds
L159 for **D** Price Key Molds
Handles are included with A Price Key Molds
- Flint Ignitor** **T320** (Included with handle clamp or frame but also available separately)

SUGGESTED TOOLS

- | | |
|----------------------|----------------|
| Cable Cleaning Brush | T313 or T314 |
| Slag Removal Spade | B136A or B136B |
| Mold Cleaning Brush | T394 |
| Rasp | T321 |
| Torch Head | T111 |

ACCESSORIES

See Section A

TYPE HC

CABLE SIZE	MOLD PART NO.	WELD METAL
6*	H C A-1H	45
4	H C A-1L	45
2 SOL	H C A-1T	45
2	H C A-1V	45
1	H C A-1Y	65

TYPE HT

CABLE SIZE	MOLD PART NO.	WELD METAL
1/0	H T C-2C	90
2/0	H T C-2G	115
3/0	H T C-2L	115
4/0	H T C-2Q	150
250	H T C-2V	150
300	H T C-3A	200
350	H T C-3D	250
500	H T D-3Q	2-150

Cable to Horizontal Steel Pipe (Types **HC** and **HT**) –
Use flat surface mold part number with suffix.

Cable	Nominal Pipe Size	Suffix
#1 and Smaller	12" and smaller	Nominal Pipe Size
	14" and larger	None
1/0 thru 250	28" and smaller	Nominal Pipe Size
	30" and larger	None

Example: #1 cable to 6" pipe, H**C**A-1Y-6

*Requires B112 sleeve (2 per weld)



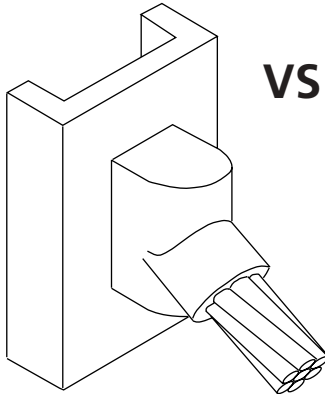

VERTICAL STEEL SURFACE

- Cable down at 45° to vertical steel surface including pipe.
- Cable to vertical flat steel surface; cable to side of vertical or horizontal steel pipe.
- CADWELD also has a complete product line for cathodic protection connections. See Bulletin CA1A.
- Concentric stranded copper cable listed.
- **A test weld should be made to check the possibility of burn through on thin sections or thin wall pipe.**
- **Bold letter** in mold part number is the price key.

REQUIRED TOOLS

Handle Clamps **L160** for **C** Price Key Molds
L159 for **D** Price Key Molds

Flint Ignitor **T320** (Included with handle clamp but also available separately)

SUGGESTED TOOLS

Cable Cleaning Brush	T313 or T314
Slag Removal Spade	B136A or B136B
Mold Cleaning Brush	T394
Rasp	T321
Torch Head	T111

ACCESSORIES

See Section A

TYPE VS		
CABLE SIZE	MOLD PART NO.	WELD METAL
6*	V S C-1H	45
4	V S C-1L	45
2 SOL	V S C-1T	45
2	V S C-1V	45
1	V S C-1Y	65
1/0	V S C-2C	90
2/0	V S C-2G	90
3/0	V S C-2L	115
4/0	V S C-2Q	115
250	V S C-2V	115
300	V S C-3A	150
350	V S C-3D	200
500	V S C-3Q	200
750	V S D-4L	2-150
1000	V S D-4Y	2-200

*Requires B112 sleeve (1 per weld)

Cable to Vertical Steel Pipe – Use flat surface mold part number; add V and suffix.		
Cable	Nominal Pipe Size	Suffix
#6 thru 250	30" and smaller	Nominal Pipe Size
	32" and larger	None
Example: 4/0 to 4" pipe, V S C-2Q-V4		
Cable to horizontal steel pipe – Add H and nominal pipe size to flat surface mold number. Example: 2/0 to 8" pipe, V S C-2G-H8		

VS

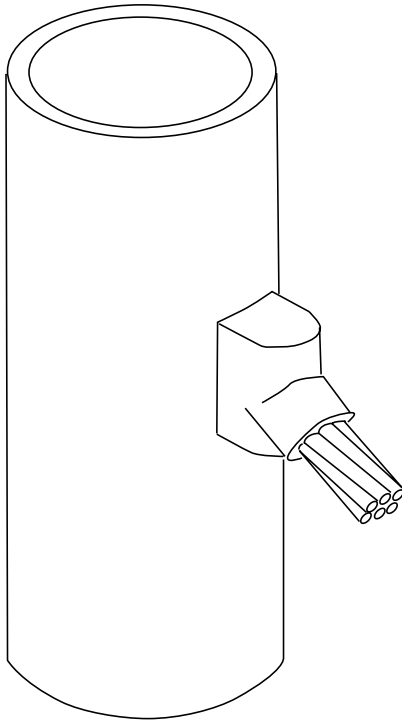

RANGE OF VERTICAL PIPES

- Cable down at 45° to range of vertical steel pipes.
- CADWELD also has a complete product line for cathodic protection connections. See Bulletin CA1A.
- **A test weld should be made to check the possibility of burn through on thin sections or thin wall pipe.**
- When only one pipe size rather than a range of sizes is involved, see Cable to Steel Pipe Table on previous page.
- Concentric stranded copper cable is listed.
- **Bold letter** in mold part number is the price key.

REQUIRED TOOLS

Handle Clamps L160 or B160V (chain support handle clamp) for **C** Price Key Mold

Flint Ignitor T320 (Included with handle clamp but also available separately)

SUGGESTED TOOLS

Cable Cleaning Brush	T313 or T314
Slag Removal Spade	B136A or B136B
Mold Cleaning Brush	T394
Rasp	T321
Torch Head	T111

ACCESSORIES

See Section A

CABLE SIZE	Nominal Pipe Size	MOLD PART NO.	WELD METAL
4	1 1/2" to 4" Pipe	V S C-1L-V3C	45
	4" to 6" Pipe	V S C-1L-V5C	45
	6" to 10" Pipe	V S C-1L-V8C	45
	12" to 30" Pipe	V S C-1L-V21C	45
	32" Pipe or Larger	(1)	
2 SOL	1 1/2" to 4" Pipe	V S C-1T-V3C	45
	4" to 6" Pipe	V S C-1T-V5C	45
	6" to 10" Pipe	V S C-1T-V8C	45
	12" to 30" Pipe	V S C-1T-V21C	45
	32" Pipe or Larger	(1)	
	1 1/2" to 4" Pipe (cable up at 45°)	V F C-1T-002V3C	45
2	1 1/2" to 4" Pipe	V S C-1V-V3C	45
	4" to 6" Pipe	V S C-1V-V5C	45
	6" to 10" Pipe	V S C-1V-V8C	45
	12" to 30" Pipe	V S C-1V-V21C	45
	32" Pipe or Larger	(1)	
1	2" to 4" Pipe	V S C-1Y-V3C	65
	4" to 6" Pipe	V S C-1Y-V5C	65
	6" to 10" Pipe	V S C-1Y-V8C	65
	12" to 30" Pipe	V S C-1Y-V21C	65
	32" Pipe or Larger	(1)	

(1) Use flat surface mold part number. See page 3-7.

CABLE SIZE	Nominal Pipe Size	MOLD PART NO.	WELD METAL
1/0	2" to 4" Pipe	V S C-2C-V3C	90
	4" to 6" Pipe	V S C-2C-V5C	90
	6" to 10" Pipe	V S C-2C-V8C	90
	12" to 30" Pipe	V S C-2C-V21C	90
	32" Pipe or Larger	(1)	
2/0	2" to 4" Pipe	V S C-2G-V3C	90
	4" to 6" Pipe	V S C-2G-V5C	90
	6" to 10" Pipe	V S C-2G-V8C	90
	12" to 30" Pipe	V S C-2G-V21C	90
	32" Pipe or Larger	(1)	
3/0	2" to 4" Pipe	V S C-2L-V3C	115
	4" to 6" Pipe	V S C-2L-V5C	115
	6" to 10" Pipe	V S C-2L-V8C	115
	12" to 30" Pipe	V S C-2L-V21C	115
	32" Pipe or Larger	(1)	
4/0	2" to 4" Pipe	V S C-2Q-V3C	115
	4" to 6" Pipe	V S C-2Q-V5C	115
	6" to 10" Pipe	V S C-2Q-V8C	115
	12" to 30" Pipe	V S C-2Q-V21C	115
	32" Pipe or Larger	(1)	



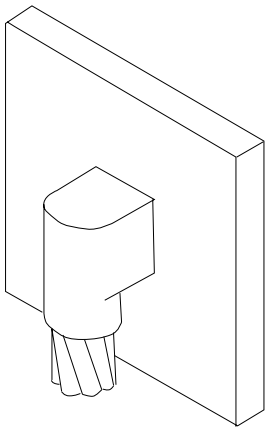

VB
Cable down to vertical steel surface

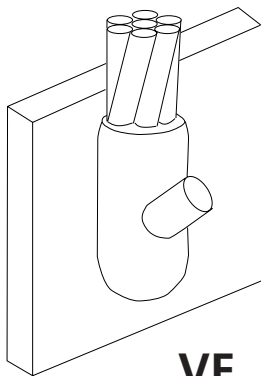

VF
Cable up to vertical steel surface

VERTICAL STEEL SURFACE

- Connection of vertical cable to vertical flat steel surface or to side of vertical or horizontal steel pipe.
- **A test weld should be made to check the possibility of burn through on thin sections or thin wall pipe.**
- Concentric stranded copper cable listed.
- Cable to steel pipe. Add pipe orientation and nominal pipe size to flat surface mold part number. Examples:
VFC-2G-V6, 2/0 conductor to vertical 6" pipe.
VFC-1Y-H4, #1 conductor to horizontal 4" pipe
- **Bold letter** in mold part number is the price key.

REQUIRED TOOLS

Handle Clamps **L160** for C and R Price Key Molds
L159 for F Price Key Molds

Flint Ignitor **T320** (Included with handle clamp but also available separately)

SUGGESTED TOOLS

Cable Cleaning Brush T313 or T314
Rasp T321
Slag Removal Spade B136A or B136B
Mold Cleaning Brush T394
Torch Head T111

ACCESSORIES

See Section A

TYPE VB		
CABLE SIZE	MOLD PART NO.	WELD METAL
4	VBC -1L	65
2 SOL	VBC -1T	65
2	VBC -1V	65
1	VBC -1Y	90
1/0	VBC -2C	115
2/0	VBC -2G	115
3/0	VBC -2L	150
4/0	VBC -2Q	150
250	VBC -2V	200
300	VBC -3A	200
350	VBC -3D	250
500	VBR -3Q	2-150

TYPE VF*		
CABLE SIZE	MOLD PART NO.	WELD METAL
4	VFC -1L	65
2 SOL	VFC -1T	65
2	VFC -1V	65
1	VFC -1Y	90
1/0	VFC -2C	150
2/0	VFC -2G	150
3/0	VFR -2L	200
4/0	VFR -2Q	200
250	VFR -2V	200
300	VFR -3A	250
350	VFF -3D	2-150
500	VFF -3Q	2-200

*See VF connection to pipe on page 3-8

VG

Cable on surface

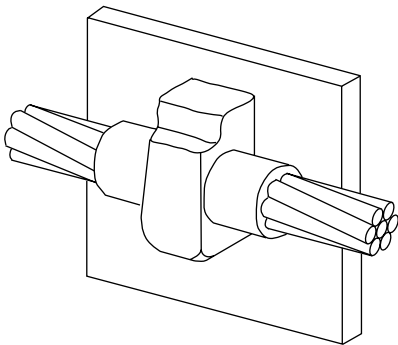
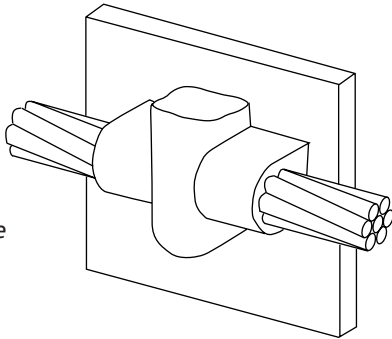

VT

Cable off surface

VERTICAL STEEL SURFACE

- CADWELD through connections to vertical flat steel surface; cable to vertical side of horizontal pipe (Type VG only); cable to vertical steel pipe (Type VT only).
- **A test weld should be made to check the possibility of burn through on thin sections or thin wall pipe.**
- Concentric stranded copper cable is listed.
- Cable to steel pipe. Add nominal pipe size to flat surface mold part number. Examples: Horizontal Pipe, Use Type VG, add nominal pipe size suffix, for 2/0 to 6 in. pipe, VGC-2G-6, for Vertical Pipe, Use Type VT, add nominal pipe size suffix, Example for 1/0 to 4 in. pipe, VTC-2C-4
- **Bold letter** in mold part number is the price key.

REQUIRED TOOLS

Handle Clamps **L160** for **C** Price Key Molds

Flint Ignitor **T320** (Included with handle clamp but also available separately)

SUGGESTED TOOLS

Cable Cleaning Brush	T313 or T314
Slag Removal Spade	B136A or B136B
Mold Cleaning Brush	T394
Rasp	T321
Torch Head	T111

ACCESSORIES

See Section A

TYPE VG		
CABLE SIZE	MOLD PART NO.	WELD METAL
6*	VGC -1H	45
4	VGC -1L	45
2 SOL	VGC -1T	45
2	VGC -1V	45
1	VGC -1Y	65
1/0	VGC -2C	115
2/0	VGC -2G	115
3/0	VGC -2L	150
4/0	VGC -2Q	150
250	VGC -2V	150

*Requires B112 sleeve (2 per weld)

TYPE VT		
CABLE SIZE	MOLD PART NO.	WELD METAL
6*	VTC -1H	65
4	VTC -1L	65
2 SOL	VTC -1T	65
2	VTC -1V	65
1	VTC -1Y	90
1/0	VTC -2C	115
2/0	VTC -2G	115
3/0	VTC -2L	150
4/0	VTC -2Q	150
250	VTC -2V	150

*Requires B112 sleeve (2 per weld)



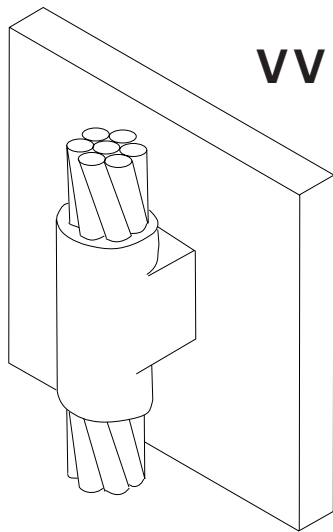

VERTICAL STEEL SURFACE

- Through connections to vertical flat surface or to side of vertical or horizontal steel pipe.
- **A test weld should be made to check the possibility of burn through on thin sections or thin wall pipe.**
- Concentric stranded copper cable is listed.
- Cable to steel pipe. Add pipe orientation and nominal pipe size to flat surface mold part number. Examples: VVR-2G-V6, 2/0 conductor to vertical 6" pipe; VVR-1V-H6, #2 to horizontal 6" pipe
- **Bold letter** in mold part number is the price key.

REQUIRED TOOLS

Handle Clamps L160 for **C** and **R** Price Key Molds

Flint Ignitor T320 (Included with handle clamp but also available separately)

SUGGESTED TOOLS

Cable Cleaning Brush	T313 or T314
Rasp	T321
Slag Removal Spade	B136B
Mold Cleaning Brush	T394
Torch Head	T111

ACCESSORIES















See Section A

TYPE VV		
CABLE SIZE	MOLD PART NO.	WELD METAL
6*	V V C-1H	90
4	V V C-1L	90
2 SOL	V V C-1T	115
2	V V C-1V	115
1	V V C-1Y	115
1/0	V V R-2C	200
2/0	V V R-2G	200
3/0	V V R-2L	250
4/0	V V R-2Q	250
250	V V R-2V	250

*Requires B112 sleeve (2 per weld)

OTHER CABLE TO STEEL OR CAST IRON

The connections shown below are for use only where connections shown in this catalog are not suitable.

NAME	TYPE		EASE	SPLIT	NAME	TYPE		EASE	SPLIT
Tap Cast Iron	VH		1	V	Tap Steel	VA		1	V
	VJ		1	V		VC		1	V
	VK		1	V		VE		2	V
	VL		1	V	Thru Cast Iron	HE		1	*
	VR		1	V	Thru Steel	HH		2	*
Tap Steel	HF		1	*		HJ		2	*
	HG		2	*		HK		1	V
						VX		2	V



NEMA LUGS
Page 2

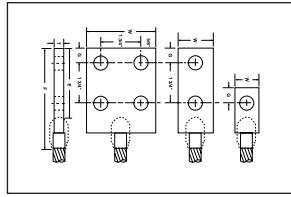

**Prefabricated
Lug Bonds**
Page 5

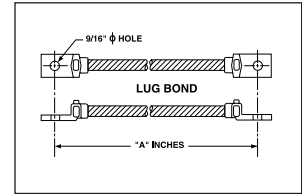

LA
Page 3

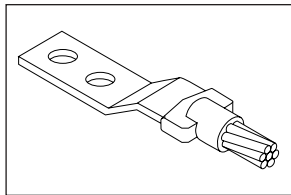

Telecom Lugs
Page 6

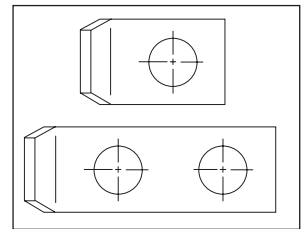

GL
Page 4

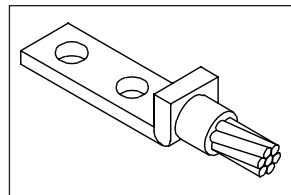

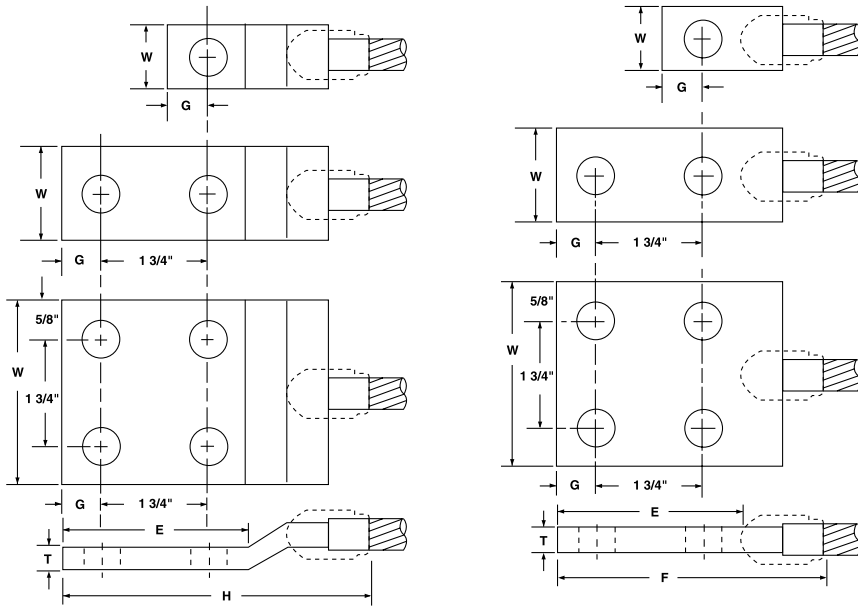

LA Offset Lug

LA Straight Lug

LUGS FOR TYPE LA LUG CONNECTIONS

NEMA lugs for Type LA connections are made from electrolytic grade copper bar stock to provide an efficient bolting surface for grounding and power applications. All listed lugs are tin plated. Telephone type lugs also available. Contact ERICO.

For sizes not listed or for 45° or 90° lugs, contact ERICO.

Lug Size	No. of Holes	Bolt Size	LA Lug Part No.		T	Dimensions in Inches					Size in Kcmil
			Straight	Offset		W	G	E	F*	H*	
1/8 x 1	1	3/8	B-101-CE	B-101-CE-OL	1/8	1	1/2	7/8	2-3/8	3-1/8	159
	2	1/2	B-102-CE	B-102-CE-OL	1/8	1	5/8	3	4-1/2	5-1/4	159
3/16 x 1	1	1/2	B-101-DE	B-101-DE-OL	3/16	1	9/16	1-1/8	2-7/8	3-5/8	239
	2	1/2	B-102-DE	B-102-DE-OL	3/16	1	5/8	3	4-3/4	5-1/2	239
	2**	3/8		B-103-DE-OL	3/16	1	7/16	1-7/8		4-3/8	239
1/4 x 1	1	1/2	B-101-EE	B-101-EE-OL	1/4	1	5/8	1-1/8	3	3-5/8	318
	2	1/2	B-102-EE	B-102-EE-OL	1/4	1	5/8	3	4-7/8	5-5/8	318
1/4 x 1-1/2	1	5/8	B-101-EG	B-101-EG-OL	1/4	1-1/2	3/4	1-1/2	3	4-1/8	478
	2	1/2	B-102-EG	B-102-EG-OL	1/4	1-1/2	5/8	3	4-7/8	5-5/8	478
1/4 x 2	2	1/2	B-102-EH	B-102-EH-OL	1/4	2	5/8	3	5-1/4	6	637
3/8 X 1-1/2	1	5/8	B-101-GG	B-101-GG-OL	3/8	1-1/2	3/4	1-1/2	3-3/4	4-3/4	716
	2	1/2	B-102-GG	B-102-GG-OL	3/8	1-1/2	5/8	3	5-3/4	7	716
3/8 X 2	1	5/8	B-101-GH	B-101-GH-OL	3/8	2	1	2-1/8	4-3/8	5-5/8	955
	2	1/2	B-102-GH	B-102-GH-OL	3/8	2	5/8	3	5-3/4	7	955
1/2 X 2	2	1/2	B-102-JH	B-102-JH-OL	1/2	2	5/8	3	5-3/4	7	1374
1/4 x 3	4	1/2	B-104-EK	B-104-EK-OL	1/4	3	5/8	3	5-1/2	6-1/4	955
3/8 X 3	4	1/2	B-104-GK	B-104-GK-OL	3/8	3	5/8	3	6	7	1432
1/2 X 3	4	1/2	B-104-JK	B-104-JK-OL	1/2	3	5/8	3	6-1/4	7-1/4	1910

* Approximate

** Non-NEMA drillings. Two holes for 3/8" screws on 1" centers. For use with B-161-2Q CADWELD Ground Plate.



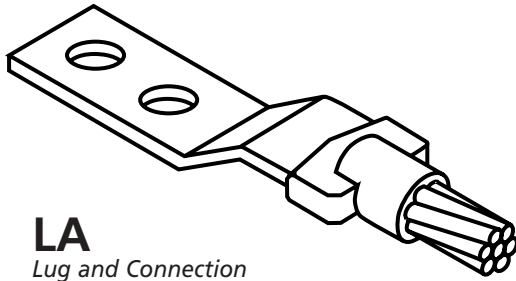

LA
Lug and Connection

COPPER LUGS

- Cable to lug or busbar connections. Can be either field fabricated from copper busbar or factory-made lugs. Ideal for power applications. Connection must be made with cable and lug horizontal.
- Concentric stranded copper cable is listed.
- **Bold letter** in mold part number is the price key.

REQUIRED TOOLS

Handle Clamps **L160** for **C** Price Key Molds
L159 for **D** Price Key Molds

Flint Ignitor **T320** (Included with handle clamp but also available separately)

SUGGESTED TOOLS

Cable Cleaning Brush T313 or T314
Slag Removal Spade B136A or B136B
Mold Cleaning Brush T394
Torch Head T111

ACCESSORIES

See Section A

CABLE SIZE	BUS OR LUG SIZE	MOLD PART NUMBER	WELD METAL
4	1/8 x 1	LAC-1LCE	45
2 SOL	1/8 x 1	LAC-1TCE	45
2	1/8 x 1	LAC-1VCE	45
1	1/8 x 1	LAC-1YCE	45
1/0	1/8 x 1	LAC-2CCE	45
	3/16 x 1	LAC-2CDE	65
	1/4 x 1	LAC-2CEE	65
2/0	1/8 x 1	LAC-2GCE	65
	3/16 x 1	LAC-2GDE	65
	1/4 x 1	LAC-2GEE	65
3/0	1/8 x 1	LAC-2LCE	65
	3/16 x 1	LAC-2LDE	90
	1/4 x 1	LAC-2LEE	90
4/0	3/16 x 1	LAC-2QDE	90
	1/4 x 1	LAC-2QEE	90
	1/4 x 1 1/2	LAC-2QEG	90
	1/4 x 2	LAC-2QEH	90
	1/4 x 3	LAC-2QEK	90
250	3/16 x 1	LAC-2VDE	90
	1/4 x 1	LAC-2VEE	90
	1/4 x 1 1/2	LAC-2VEG	90
	1/4 x 2	LAC-2VEH	90
	1/4 x 3	LAC-2VEK	90
300	1/4 x 1	LAC-3AEE	90
	1/4 x 1 1/2	LAC-3AEG	90
	1/4 x 2	LAC-3AEH	90
	1/4 x 3	LAC-3AEK	90

CABLE SIZE	BUS OR LUG SIZE	MOLD PART NUMBER	WELD METAL
350	1/4 x 1	LAC-3DEE	115
	1/4 x 1 1/2	LAC-3DEG	115
	1/4 x 2	LAC-3DEH	115
	1/4 x 3	LAC-3DEK	115
500	1/4 x 1 1/2	LAC-3QEG	200
	1/4 x 2	LAC-3QEH	200
	1/4 x 3	LAC-3QEK	200
	3/8 x 1 1/2	LAC-3QGG	200
750	1/4 x 2	LAD-4LEH	2-150
	1/4 x 3	LAD-4LEK	2-150
	3/8 x 1 1/2	LAD-4LGG	2-150
	3/8 x 2	LAD-4LGH	2-150
	3/8 x 3	LAD-4LGK	2-150
1000	1/4 x 3	LAD-4YEK	2-200
	3/8 x 2	LAD-4YGH	2-200
	3/8 x 3	LAD-4YGK	2-200
	1/2 x 2	LAD-4YJH	500
	1/2 x 3	LAD-4YJK	500

See Pg 4-2 for Lugs.

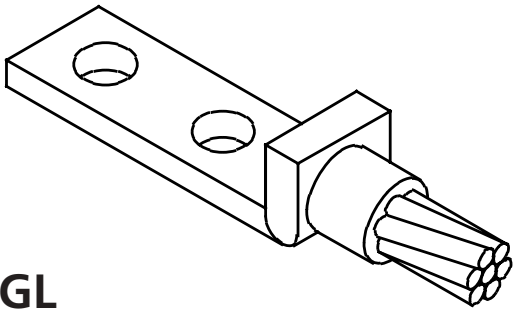

GL
Lug and Connection

1-HOLE

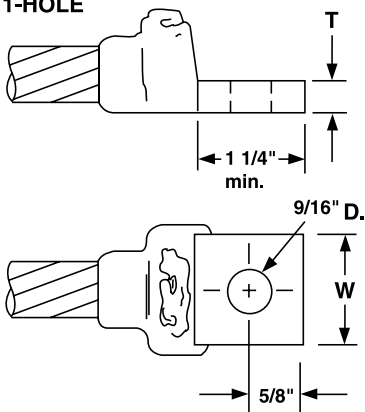

NEMA Drilled Lugs-B-121 Series

All lugs are tin-plated copper.
Pat. No. 4,196,960

2-HOLE

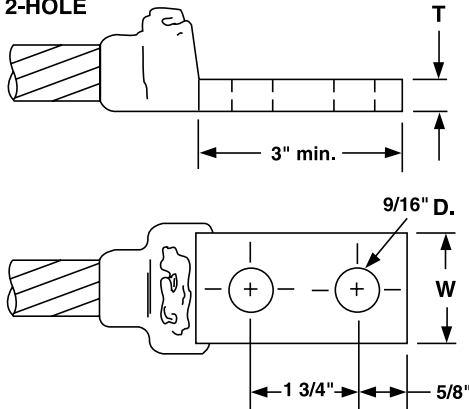

NEMA Drilled Lugs-B-122 Series

COPPER LUGS

- Lugs and connections for equipment and structures. Ideal for power applications.
- Concentric stranded copper cable is listed.
- **Bold letter** in mold part number is the price key.

REQUIRED TOOLS

Handle Clamps L160 for C Price Key Molds

Flint Ignitor T320 (Included with handle clamp but also available separately)

SUGGESTED TOOLS

Cable Cleaning Brush	T313 or T314
Slag Removal Spade	B136A or B136B
Mold Cleaning Brush	T394
Torch Head	T111

ACCESSORIES

See Section A

CABLE SIZE	MOLD NUMBER	WELD METAL	LUG SIZE T X W	GL LUG NUMBER	
				1 HOLE	2 HOLES
4	GL C -CE1L	32	1/8 x 1	B-121-CE	B-122-CE
2 SOL	GL C -CE1T	32	1/8 x 1	B-121-CE	B-122-CE
2	GL C -CE1V	32	1/8 x 1	B-121-CE	B-122-CE
1	GL C -CE1Y	32	1/8 x 1	B-121-CE	B-122-CE
1/0	GL C -CE2C	45	1/8 x 1	B-121-CE	B-122-CE
2/0	GL C -CE2G	45	1/8 x 1	B-121-CE	B-122-CE
3/0	GL C -CE2L	65	1/8 x 1	B-121-CE	B-122-CE
4/0	GL C -DE2Q	65	3/16 x 1	B-121-DE	B-122-DE
250	GL C -DE2V	65	3/16 x 1	B-121-DE	B-122-DE
300	GL C -EE3A	90	1/4 x 1	B-121-EE	B-122-EE
350	GL C -EE3D	90	1/4 x 1	B-121-EE	B-122-EE
500	GL C -EG3Q	150	1/4 x 1 1/2	B-121-EG	B-122-EG



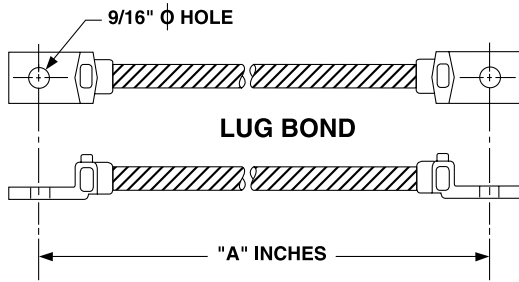

PREFABRICATED LUG BONDS

Prefabricated lug bonds are custom made to your specifications. Common usage includes cable tray bonding and grounding, structure bonds, surge arrester leads and power jumpers.

Specifications:

Prefabricated Lug Bonds (lug stub bonds) shall be made using bare annealed copper cable conforming to ASTM B8, Class A with a tinned pure copper lug conforming to ASTM B-187 on both ends (or one end only), welded to the cable with CADWELD Type GL connections.

Note:

Also available for other sizes or stranding or for insulated cable.

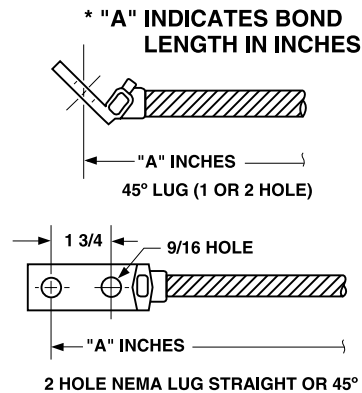
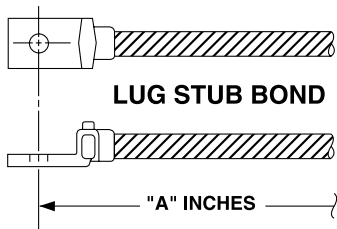

CABLE Size	Str.	LUG SIZE	LUG BOND CAT. NO.*			
			One Hole	Two Hole	One Hole 45°	Two Hole 45°
4	7	1/8 x 1	B-212-1L-A	B-213-1L-A	B-214-1L-A	B-215-1L-A
2	7	1/8 x 1	B-212-1V-A	B-213-1V-A	B-214-1V-A	B-215-1V-A
1	7	1/8 x 1	B-212-1Y-A	B-213-1Y-A	B-214-1Y-A	B-215-1Y-A
1/0	7	1/8 x 1	B-212-2C-A	B-213-2C-A	B-214-2C-A	B-215-2C-A
2/0	7	1/8 x 1	B-212-2G-A	B-213-2G-A	B-214-2G-A	B-215-2G-A
4/0	7	3/16 x 1	B-212-2Q-A	B-213-2Q-A	B-214-2Q-A	B-215-2Q-A
250	19	3/16 x 1	B-212-2V-A	B-213-2V-A	B-214-2V-A	B-215-2V-A

CABLE Size	Str.	LUG SIZE	LUG STUB BOND CAT. NO.*			
			One Hole	Two Hole	One Hole 45°	Two Hole 45°
4	7	1/8 x 1	B-216-1L-A	B-217-1L-A	B-218-1L-A	B-219-1L-A
2	7	1/8 x 1	B-216-1V-A	B-217-1V-A	B-218-1V-A	B-219-1V-A
1	7	1/8 x 1	B-216-1Y-A	B-217-1Y-A	B-218-1Y-A	B-219-1Y-A
1/0	7	1/8 x 1	B-216-2C-A	B-217-2C-A	B-218-2C-A	B-219-2C-A
2/0	7	1/8 x 1	B-216-2G-A	B-217-2G-A	B-218-2G-A	B-219-2G-A
4/0	7	3/16 x 1	B-216-2Q-A	B-217-2Q-A	B-218-2Q-A	B-219-2Q-A
250	19	3/16 x 1	B-216-2V-A	B-217-2V-A	B-218-2V-A	B-219-2V-A

* "A" indicates bond length in inches.

TELECOM LUGS



ORDERING INFORMATION

CADWELD Telecom Mold Part No. is **GLPCC001TC** and includes B399B Mini EZ change handle clamp and T320 flint ignitor. CADWELD weld metal size #25 works for all 7 lug sizes.

ONE HOLE UPTURN LUG						
Part Number	Thickness A	Width B	Length C	Centers D	E	Bolt Size F
B921CC14	.125	.63	.875	N/A	.375	1/4"
B921CC38	.125	.63	.875	N/A	.375	3/8"

Note: All CADWELD lugs are electrotin plated copper alloy.

TWO HOLE UPTURN LUG						
Part Number	Thickness A	Width B	Length C	Centers D	E	Bolt Size F
B922CC14A	.125	.63	1.88	.625	.375	1/4"
B922CC14B	.125	.63	1.88	.75	.375	1/4"
B922CC14C	.125	.63	1.88	1	.375	1/4"
B922CC38B	.125	.63	1.88	.75	.375	3/8"
B922CC38C	.125	.63	1.88	1	.375	3/8"

Note: All CADWELD lugs are electrotin plated copper alloy.

SLEEVE REQUIREMENTS			
Conductor Size(s)		Sleeve No.	Qty per Package
Concentric	Solid		
#6	#5	B112	25
#4 & #5	#3 & #4	B1331V	25
N/A	#2	S429F1N12	25
#2	N/A	No Sleeve Required	N/A

One Hole Lug

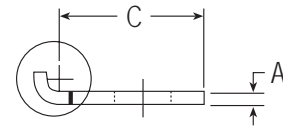
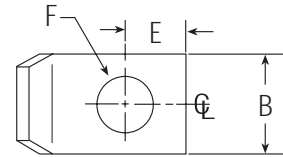

Two Hole Lug

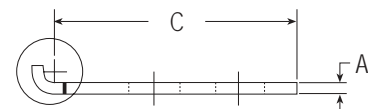
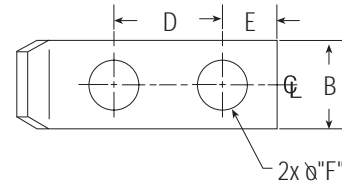

OTHER RELATED PRODUCTS

TELEPHONE LUGS (Two Holes for 3/8" Bolts on 1" Centers)				
Lug Size	Type GL	Type LA		Maximum Conductor
		Straight	Offset	
1/8" x 1"	B123CE03	B103CEOL003	B103CEOL003	3/0 AWG
3/16"	B123DE03	B123DE001	B103DEOL	250 kcmil
1/4" x 1"	B123EE03	B103EE002	B103EEOL003	350 kcmil
1/4" x 1 1/2"	B123EG03	B103EG002	B103EGOL001	500 kcmil
3/8" x 2"	N/A	B103GH003	B103GHOL004	1000 kcmil

For Type GL lugs, use Type GL molds as listed in Catalog A1A.
For Type LA lugs, use Type LA molds as listed in Catalog A1A.

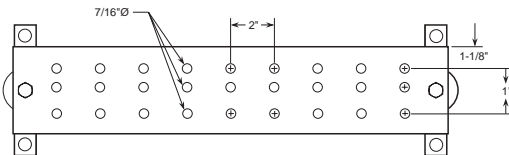
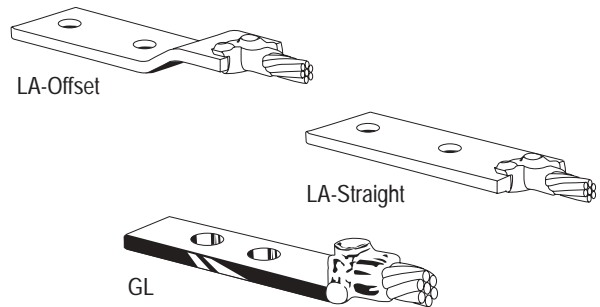

Ground Bar P/N EGBA14420CC (1/4 x 4 x 20")

GROUND BARS for Single Point Grounding

Many ground bar sizes are in stock and available. Contact ERICO for stock sizes or custom requirements. Shown at left is a typical bar size.

Notes:

- All assemblies include insulators and mounting brackets.
- Insulators are 2700 volts indoor rating.
- Also available without insulators.
- Also available with cable pigtailed welded to bar. Specify cable size, length and insulation type.
- Other bar sizes, hole sizes, spacing, etc. available on special order.



LQ
Page 2

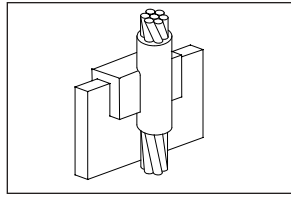

LJ
Page 3

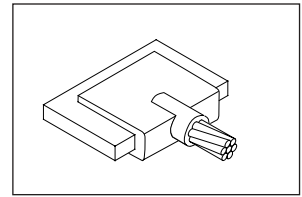

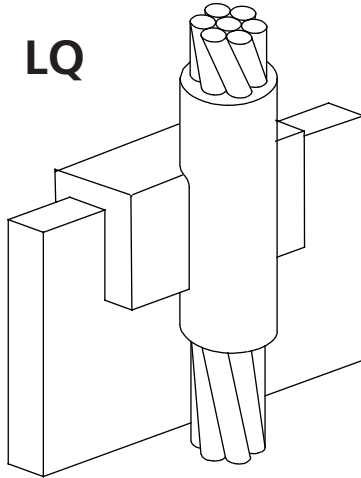

CABLE TO BUSBAR

- Through vertical conductor to top of horizontal busbar with face in vertical plane.
- Concentric stranded copper cable is listed.
- **Bold letter** in mold part number is the price key.

REQUIRED TOOLS

Handle Clamps **L160** for *E* Price Key Molds
L159 for *J* Price Key Molds

Flint Ignitor **T320** (Included with handle clamp but also available separately)

SUGGESTED TOOLS

Cable Cleaning Brush	T313 or T314
Slag Removal Spade	B136B
Mold Cleaning Brush	T394
Torch Head	T111
Mold Support Bracket	B854A1

ACCESSORIES

See Section A

BUS SIZE	CABLE SIZE	MOLD PART NO.	WELD METAL
1/4" X 2" & Wider	2	LQ E -EH1V	250
	2 SOL	LQ E -EH1T	250
	1	LQ J -EH1Y	2-150
	1/0	LQ J -EH2C	2-200
	2/0	LQ J -EH2G	2-200
	4/0	LQ J -EH2Q	500
	250	LQ J -EH2V	500
	500	LQ J -EH3Q	500
	750	LQ J -EH4L	3-200
	3/8" X 2" & Wider	2	LQ E -GH1V
2 SOL		LQ E -GH1T	250
1		LQ J -GH1Y	2-150
1/0		LQ J -GH2C	2-200
2/0		LQ J -GH2G	2-200
4/0		LQ J -GH2Q	500
250		LQ J -GH2V	500
500		LQ J -GH3Q	500
750		LQ J -GH4L	3-200

BUS SIZE	CABLE SIZE	MOLD PART NO.	WELD METAL
1/2" X 2" & Wider	2	LQ J -JH1V	2-150
	2 SOL	LQ J -JH1T	2-150
	1	LQ J -JH1Y	2-200
	1/0	LQ J -JH2C	500
	2/0	LQ J -JH2G	500
	4/0	LQ J -JH2Q	3-200
	250	LQ J -JH2V	3-200
	500	LQ J -JH3Q	3-200
	750	LQ J -JH4L	3-250

Also available for other bus sizes and other cable sizes.



LJ

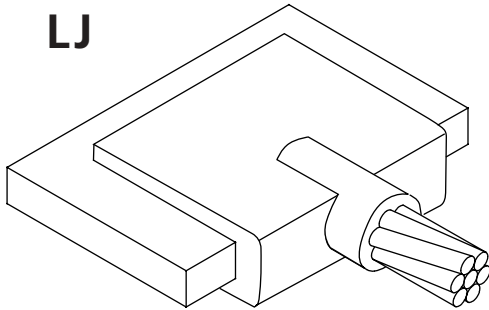

CABLE TO BUSBAR

- Tap of horizontal cable to edge of horizontal, flat busbar.
- Concentric stranded copper cable is listed.
- The minimum distance between centers of adjacent welds is indicated as "C" dimension.
- **Bold letter** in mold part number is the price key.

REQUIRED TOOLS

Handle Clamps **L160** for **C** Price Key Molds
L159 for **D** Price Key Molds

Flint Ignitor **T320** (Included with handle clamp but also available separately)

SUGGESTED TOOLS

Cable Cleaning Brush	T313 or T314
Slag Removal Spade	B136B
Mold Cleaning Brush	T394
Torch Head	T111

ACCESSORIES











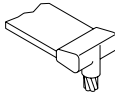
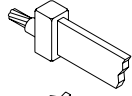
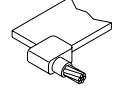
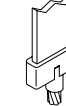
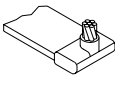
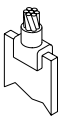

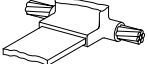

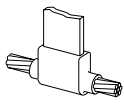
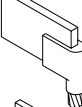
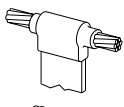
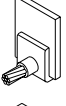
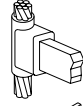
See Section A

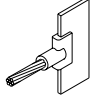
CONDUCTOR SIZE BUSBAR	CABLE	MOLD PART NO.	WELD METAL	Min. "C" Dimension
1/4" x 1-1/2" & Wider	2 SOL 2	L J C-EG1T	65	1-3/4"
		L J C-EG1V	65	1-3/4"
	1/0 2/0 3/0 4/0	L J C-EG2C	90	1-3/4"
		L J C-EG2G	90	1-3/4"
		L J C-EG2L	90	1-3/4"
		L J C-EG2Q	90	1-3/4"
	250 300 350 500	L J C-EG2V	115	2"
		L J C-EG3A	115	2"
		L J C-EG3D	150	2"
		L J C-EG3Q	200	2"
3/8" x 1-1/2" & Wider	2 SOL 2	L J C-GG1T	65	1-3/4"
		L J C-GG1V	65	1-3/4"
	1/0 2/0 3/0 4/0	L J C-GG2C	90	1-3/4"
		L J C-GG2G	90	1-3/4"
		L J C-GG2L	115	1-3/4"
		L J C-GG2Q	115	1-3/4"
	250 300 350	L J C-GG2V	150	1-3/4"
		L J C-GG3A	150	2"
		L J C-GG3D	200	2"
	500 750 1000	L J C-GG3Q	250	2-1/4"
		L J D-GG4L	2-150	2-1/2"
		L J D-GG4Y	2-200	2-5/8"

CONDUCTOR SIZE BUSBAR	CABLE	MOLD PART NO.	WELD METAL	Min. "C" Dimension
1/2" x 1-1/2" & Wider	2 SOL 2	L J C-JG1T	90	1-3/4"
		L J C-JG1V	90	1-3/4"
	1/0 2/0 3/0 4/0	L J C-JG2C	115	1-3/4"
		L J C-JG2G	115	1-3/4"
		L J C-JG2L	150	1-3/4"
		L J C-JG2Q	150	1-3/4"
	250 300 350	L J C-JG2V	200	1-3/4"
		L J C-JG3A	200	1-3/4"
		L J C-JG3D	250	2-1/8"
	500 750 1000	L J D-JG3Q	2-150	2-1/2"
		L J D-JG4L	2-200	2-1/2"
		L J D-JG4Y	500	2-9/16"

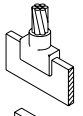
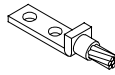
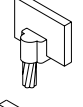
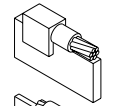
OTHER CABLE TO BUSBAR OR LUG

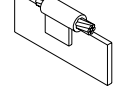
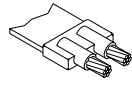
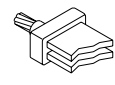
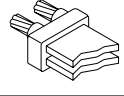
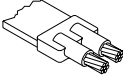
The connections shown below are for use only where connections shown in this catalog are not suitable.

NAME	PAGE	TYPE	EASE	SPLIT	NAME	PAGE	TYPE	EASE	SPLIT	
EII		DN		2	V	Splice	LB		1	V
		LX		2	*		LC		3	V
		LY		3	*		LD		3	V
		MA		2	*		LE		1	*
		MB		3	*		LF		3	*
		MC		3	*		LG		3	V
		MD		3	*		LH		3	*
		ME		2	*		LK		2	V
		MF		3	*		LL		1	V
		MG		2	V		LM		1	V
Lug		PL		1	V	LN		4	*	
Parallel tap		LV		1	V	LP		2	*	
Parallel thru		LW		1	V	LS		2	*	
Splice		DM		2	*	LT		2	*	
		DS		2	*	Tee	LR		2	*



BQ
Page 2

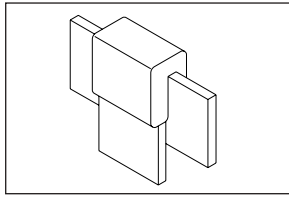

BA
Page 3

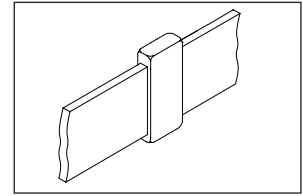

EP
Page 3

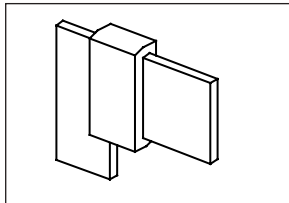

BQ

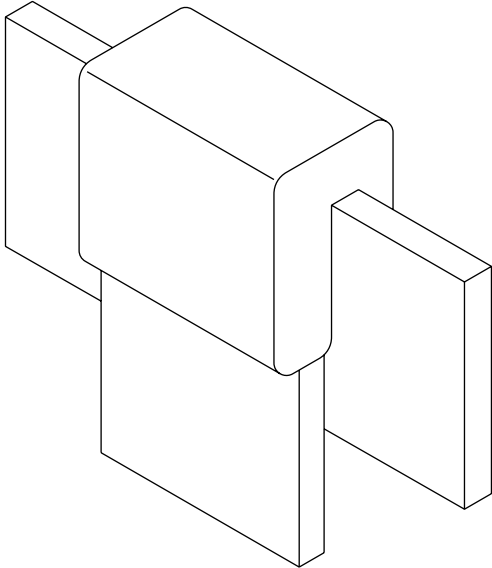

BUSBAR

- Tee tap down - horizontal, on edge, busbars
- **Bold letter** in mold part number is the price key.

REQUIRED TOOLS

Handle Clamps L160 for **C** Price Key Molds

L159 for **D** and **F** Price Key Molds

Handles are included with **K** price key molds

Flint Ignitor

T320 (Included with handle clamp or frame but also available separately)

SUGGESTED TOOLS

Slag Removal Spade	B136B
Mold Cleaning Brush	T394
Torch Head	T111

ACCESSORIES

See Section A

Run	BUSBAR SIZE Tap	MOLD PART NO.	WELD METAL
1/8 x 1 x 2 & Wider	1/8 x 1	BQC -CECE	90
	1/8 x 2	BQC -CHCH	200
3/16 x 1 x 2 & Wider	3/16 x 1	BQC -DEDE	115
	3/16 x 2	BQC -DHDH	200
1/4 x 1 x 1 1/4 x 1 1/2 x 2 & Wider x 3 & Wider x 4 & Wider	1/4 x 1	BQC -EEEE	150
	1/4 x 1 1/4	BQC -EFEF	200
	1/4 x 1 1/2	BQC -EGEG	250
	1/4 x 2	BQD -EHEH	2-200
	1/4 x 3	BQF -EKEK	2-200
	1/4 x 4	BQK -EMEM*	3-250
3/8 x 1 x 1 1/2 x 2 & Wider x 3 & Wider x 4 & Wider	3/8 x 1	BQC -GEGE	250
	3/8 x 1 1/2	BQD -GGGG	2-200
	3/8 x 2	BQD -GHGH	500
	3/8 x 3	BQF -GKGK	3-250
	3/8 x 4	BQK -GMGM*	2-500
1/2 x 1 x 2 & Wider	1/2 x 1	BQD -JEJE	2-150
	1/2 x 2	BQD -JHJH	3-250

*Requires M783 Crucible. Order Separately.



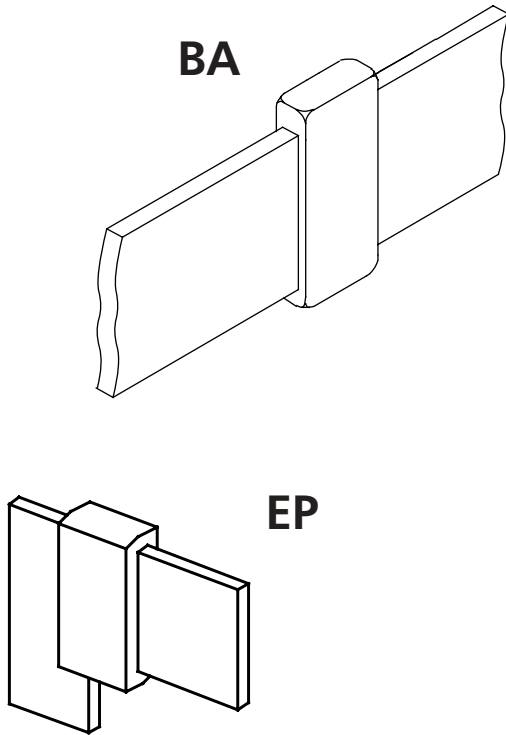

BUSBAR

- Type BA - Horizontal, on edge, busbars
- Type EP - Ell, tap down - Horizontal, on edge, busbars
- **Bold letter** in mold part number is the price key.

REQUIRED TOOLS

Handle Clamps **L160** for **C** Price Key Molds

L159 for **D** Price Key Molds

Flint Ignitor **T320** (Included with handle clamp but also available separately).

SUGGESTED TOOLS

Slag Removal Spade B136A or B136B

Mold Cleaning Brush T394

Torch Head T111

ACCESSORIES

See Section A

TYPE BA CONNECTIONS		
BUSBAR SIZE	MOLD PART NO.	WELD METAL
x 1	BAC -CE	45
x 1-1/2	BAC -CG	65
1/8 x 2	BAC -CH	90
x 3	BAC -CK	200
x 4	BAD -CM	250
3/16 x 1	BAC -DE	65
x 2	BAC -DH	115
x 1	BAC -EE	90
x 1-1/4	BAC -EF	115
x 1-1/2	BAC -EG	150
1/4 x 2	BAC -EH	200
x 2-1/2	BAC -EJ	250
x 3	BAD -EK	2-200
x 4	BAD -EM	500
x 1	BAC -GE	150
x 1-1/2	BAC -GG	250
3/8 x 2	BAD -GH	2-150
x 3	BAD -GK	500
x 4	BAD -GM	3-200
1/2 x 1	BAC -JE	200
x 2	BAD -JH	2-200

TYPE EP CONNECTIONS		
BUSBAR SIZE	MOLD PART NO.	WELD METAL
x 1	EPC -CE	45
x 1-1/2	EPC -CG	65
1/8 x 2	EPC -CH	90
x 3	EPC -CK	200
x 4	EPD -CM	250
3/16 x 1	EPC -DE	65
x 2	EPC -DH	115
x 1	EPC -EE	90
x 1-1/4	EPC -EF	115
x 1-1/2	EPC -EG	150
1/4 x 2	EPC -EH	200
x 2-1/2	EPC -EJ	250
x 3	EPD -EK	2-200
x 4	EPD -EM	500
x 1	EPC -GE	150
x 1-1/2	EPC -GG	250
3/8 x 2	EPD -GH	2-150
x 3	EPD -GK	500
x 4	EPD -GM	3-200
1/2 x 1	EPC -JE	200
x 2	EPD -JH	2-200

OTHER BUSBAR CONNECTIONS

The connections shown below are for use only where connections shown in this catalog are not suitable.

NAME	TYPE		EASE	SPLIT	NAME	TYPE		EASE	SPLIT
Button-weld	TW		1	*	Splice	BH		4	V
	TX		1	V		Tee	BK		2
EII	DJ		4	V	BL			3	*
	EN		2	*	BM			2	*
	EQ		4	V	BN			3	*
	ER		2	*	BR			2	V
	ES		3	*	BS			2	V
	ET		2	V	BT			4	*
	EV		3	*	BV			3	*
Parallel tap	BJ		2	V	DE			3	V
	Splice	BB		2	*		EE		3
BC			3	V	X	EA		4	V
BD			3	*		EB		4	*
BF			2	*		EC		4	*
BG			2	*		ED		4	V



BW
Page 2

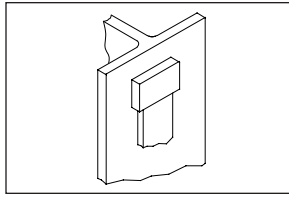

CF
Page 2

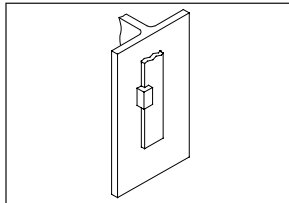

CH
Page 3

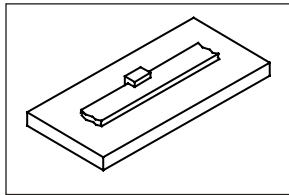

CC
Page 3

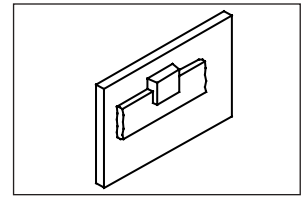

CG
Page 3

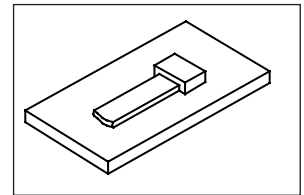

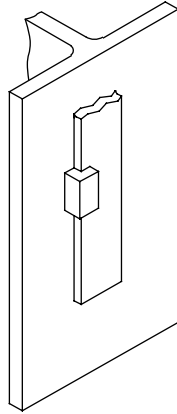
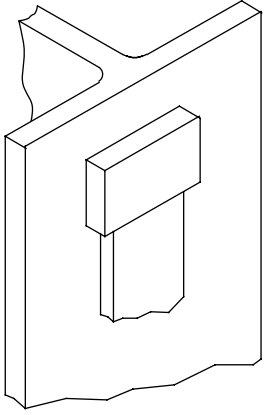

BW Tap down of busbar to vertical steel

CF Vertical bus runs to vertical steel surface

BUSBAR TO STEEL SURFACE

- A test weld should be made to check the possibility of burn through when intended for use on thin sections or thin wall pipe.
- **Bold letter** in mold part number is the price key.

REQUIRED TOOLS

Handle Clamps **L160** for **C** Price Key Molds
L159 for **D** Price Key Molds

Flint Ignitor **T320** (Included with handle clamp but also available separately).

SUGGESTED TOOLS

Cable Cleaning Brush	T313 or T314
Slag Removal Spade	B136B
Mold Cleaning Brush	T394
Rasp	T321
Torch Head	T111

ACCESSORIES

See Section A

BUSBAR SIZE	MOLD PART NO.		WELD METAL	
	BW	CF		
1/8	x 1	BW C -CE	C F C-CE	115
	x 1-1/2	BW C -CG	C F C-CG	150
	x 2	BW C -CH	—	200
	x 2 & Wider	—	C F C-CH	200
3/16	x 1	BW C -DE	C F C-DE	150
	x 1-1/2	BW C -DG	C F C-DG	200
	x 2	BW C -DH	—	250
	x 2 & Wider	—	C F C-DH	250
1/4	x 1	BW C -EE	C F C-EE	150
	x 1-1/4	BW C -EF	C F C-EF	200
	x 1-1/2	BW C -EG	C F C-EG	250
	x 2	BW D -EH	—	2-150
x 2 & Wider	—	C F D-EH	2-150	
3/8	x 1	BW C -GE	C F C-GE	200
	x 1-1/2	BW C -GG	C F C-GG	250
	x 2	BW D -GH	—	2-200
	x 2 & Wider	—	C F D-GH	2-200
1/2	x 1	BW C -JE	C F C-JE	250
	x 1-1/2	BW D -JG	C F D-JG	2-200
	x 2	BW D -JH	—	500
	x 2 & Wider	—	C F D-JH	500



CC Horizontal on-edge bus run to vertical steel surface

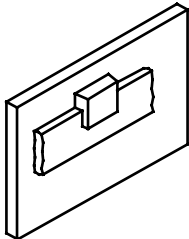

CG Horizontal bus tap to horizontal steel surface

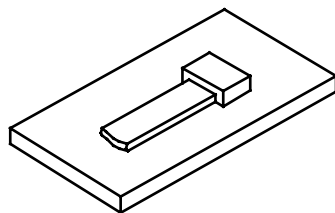

CH Horizontal bus run to horizontal steel surface

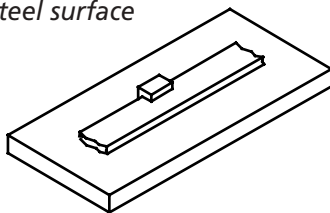

BUSBAR TO STEEL SURFACE

- A test weld should be made to check the possibility of burn through when intended for use on thin sections or thin wall pipe.
- **Bold letter** in mold part number is the price key.

REQUIRED TOOLS

Handle Clamps **L160** for **C** Price Key Molds
L159 for **D** Price Key Molds

Flint Ignitor **T320** (Included with handle clamp but also available separately)

SUGGESTED TOOLS

Cable Cleaning Brush	T313 or T314
Slag Removal Spade	B136B
Mold Cleaning Brush	T394
Rasp	T321
Torch Head	T111



ACCESSORIES

See Section A

BUSBAR SIZE	MOLD PART NO.			WELD METAL	
	CC	CG	CH		
1/8	x 1	CCC -CE	CGC -CE	CHC -CE	115
	x 1-1/2	CCC -CG	CGC -CG	—	150
	x 1-1/2 & Wider	—	—	CHC -CG	150
	x 2	—	CGC -CH	—	200
	x 2 & Wider	CCC -CH	—	—	200
3/16	x 1	CCC -DE	CGC -DE	CHC -DE	150
	x 1-1/2	CCC -DG	CGC -DG	—	200
	x 1-1/2 & Wider	—	—	CHC -DG	200
	x 2	—	CGC -DH	—	250
	x 2 & Wider	CCC -DH	—	—	250
1/4	x 1	CCC -EE	CGC -EE	CHC -EE	150
	x 1-1/4	CCC -EF	CGC -EF	CHC -EF	200
	x 1-1/2	CCC -EG	CGC -EG	—	250
	x 1-1/2 & Wider	—	—	CHC -EG	250
	x 2	—	CGD -EH	—	2-150
	x 2 & Wider	CCD -EH	—	—	2-150
3/8	x 1	CCC -GE	CGC -GE	CHC -GE	200
	x 1-1/2	CCC -GG	CGC -GG	—	250
	x 1-1/2 & Wider	—	—	CHC -GG	250
	x 2	—	CGD -GH	—	2-200
	x 2 & Wider	CCD -GH	—	—	2-200
1/2	x 1	CCC -JE	CGC -JE	CHC -JE	250
	x 1-1/2	CCD -JG	CGD -JG	—	2-200
	x 1-1/2 & Wider	—	—	CHD -JG	2-200
	x 2	—	CGD -JH	—	500
	x 2 & Wider	CCD -JH	—	—	500

OTHER BUSBAR TO STEEL SURFACE CONNECTIONS

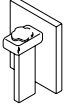
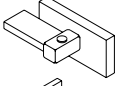
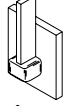
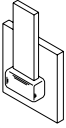
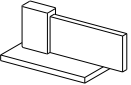
The connections shown below are for use only where connections shown in this catalog are not suitable.

NAME	TYPE		EASE	SPLIT
Tap	BX		3	V
	BY		3	V
	CA		3	V
	CB		2	V
	CJ		2	V
	DC		3	*
	DD		3	V

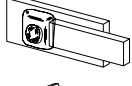
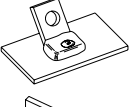
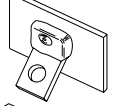
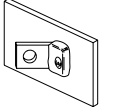
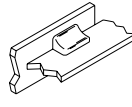
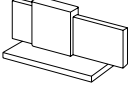
NAME	TYPE		EASE	SPLIT
Tap	DF		2	V
	HL		1	V
	HM		1	V
	HN		1	*
Thru	CD		3	V
	CK		2	V



RR
Page 4

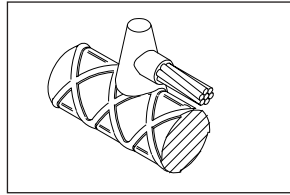

RC
Page 8

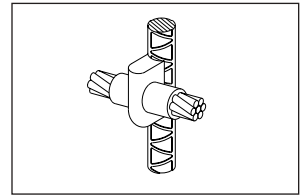

RD
Page 6

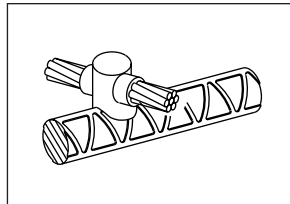

RJ
Page 10

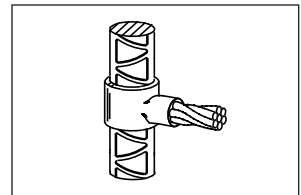

NOTES...



CADWELD® Connections Used for Grounding Reinforcing Bars

CADWELD provides efficient and permanent connections for both grounding and attaching lightning protection conductors to rebar. When making CADWELD connections to rebar, the normal materials required are: mold, handle and weld metal. In addition, packing material is also required. These materials act as a seal between the mold and rebar to prevent leaks. One unit of packing material must be ordered for each weld.

CADWELD Connections to Structural Reinforcing Bar and Anchor Bolts

Welding of ground conductors to reinforcing bars (rebar) by the CADWELD process should not be harmful if stresses in the rebar are below yield. As design stresses are normally only about 50% to 60% of the nominal yield strength of the rebar, welding by the CADWELD process should not be detrimental under design stresses.

As the ACI Building Code (ACI318-89 commentary, 12.15) advises, "splices should, if possible, be located away from points of maximum tensile stress." The same advice should apply to locations of CADWELD connections of a ground conductor to rebar. Where possible, locate the weld area away from areas of maximum tensile stress, e.g., near the free end of the bar in a lap splice, on the hook extension for a hooked bar, etc. The same considerations apply to CADWELD connections to anchor bolts.

NOTE:

For lightning protection applications where the main lightning protection conductor is connected to the rebar, ERICO recommends a 2/0 AWG copper conductor for structures over 75 feet in height and a #2 AWG copper conductor for structures under 75 feet. For a bonding conductor, a #6 AWG copper may be used. These sizes meet NFPA78 Code requirement. Anchor bolts are connected in the same way.

**All welds to rebar requiring larger than a #150 weld metal will
be sold only after review by ERICO.**

RR

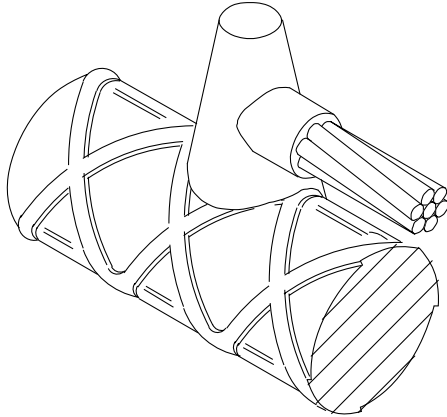

CABLE TO REBAR

- Horizontal cable tap to horizontal rebar.
- Rebar material characteristics and location of weld must be considered when selecting connections to rebar.
- Concentric stranded copper cable is listed.
- **Bold letter** in mold part number is the price key.

REQUIRED TOOLS

Handle Clamps **L160** for C Price Key Molds
Mold frame included with **A** and **H** Price Key Molds

Flint Ignitor **T320** (Included with handle clamp or frame but also available separately)

Packing One required for each connection - see tables which follow

SUGGESTED TOOLS

Cable Cleaning Brush	T313 or T314
Slag Removal Spade	B136A or B136B
Mold Cleaning Brush	T394
File	T329
Torch Head	T111

ACCESSORIES

See Section A

REBAR SIZE	CABLE SIZE	MOLD PART NO.	WELD METAL	PACKING PART NO.
3	6	RRC-511H	25	None
	4	RRC-511L	32	None
	2 SOL	RRC-511T	45	None
	2	RRC-511V	45	None
	1	RRC-511Y	65	None
	1/0	RRC-512C	90	None
	2/0	RRC-512G	90	None
	3/0	RRC-512L	115	None
	4/0	RRC-512Q	115	None
	4	6*	RRA-521H	25
4		RRA-521L	32	B-143A
2 SOL		RRA-521T	45	B-143A
2		RRA-521V	45	B-143A
1		RRA-521Y	65	B-143A
1/0		RRC-522C	90	B-141A
2/0		RRC-522G	90	B-141A
3/0		RRC-522L	115	B-141A
4/0		RRC-522Q	115	B-141A

*Requires B112 sleeve (1 per connection)

REBAR SIZE	CABLE SIZE	MOLD PART NO.	WELD METAL	PACKING PART NO.
5	6*	RRA-531H	25	B-143A
	4	RRA-531L	32	B-143A
	2 SOL	RRA-531T	45	B-143A
	2	RRA-531V	45	B-143A
	1	RRA-531Y	65	B-143A
	1/0	RRC-532C	90	B-141A
	2/0	RRC-532G	90	B-141A
	3/0	RRC-532L	115	B-141A
	4/0	RRC-532Q	115	B-141A
	6	6*	RRA-541H	25
4		RRA-541L	32	B-143B
2 SOL		RRA-541T	45	B-143B
2		RRA-541V	45	B-143B
1		RRA-541Y	65	B-143B
1/0		RRH-542C	90	B-144C
2/0		RRH-542G	90	B-144C
3/0		RRH-542L	115	B-144C
4/0		RRH-542Q	115	B-144C

*Requires B112 sleeve (1 per connection)



REBAR SIZE	CABLE SIZE	MOLD PART NO.	WELD METAL	PACKING PART NO.
7	4	RRA-551L	32	B-143B
	2	RRA-551V	45	B-143B
	2 SOL	RRA-551T	45	B-143B
	1	RRA-551Y	65	B-143B
	1/0	RRH-552C	90	B-144C
	2/0	RRH-552G	90	B-144C
	3/0	RRH-552L	115	B-144A
8	4/0	RRH-552Q	115	B-144A
	2 SOL	RRA-561T	45	B-143B
	2	RRA-561V	45	B-143B
	1	RRA-561Y	65	B-143B
	1/0	RRH-562C	90	B-144C
	2/0	RRH-562G	90	B-144C
	3/0	RRH-562L	115	B-144A
9	4/0	RRH-562Q	115	B-144A
	2 SOL	RRA-571T	45	B-143B
	2	RRA-571V	45	B-143B
	1	RRA-571Y	65	B-143B
	1/0	RRH-572C	90	B-144C
	2/0	RRH-572G	90	B-144C
	3/0	RRH-572L	115	B-144A
4/0	RRH-572Q	115	B-144A	

REBAR SIZE	CABLE SIZE	MOLD PART NO.	WELD METAL	PACKING PART NO.
10	2 SOL	RRA-581T	45	B-143B
	2	RRA-581V	45	B-143B
	1	RRA-581Y	65	B-143B
	1/0	RRH-582C	90	B-144C
	2/0	RRH-582G	90	B-144C
	3/0	RRH-582L	115	B-144A
	4/0	RRH-582Q	115	B-144A
11	2 SOL	RRA-591T	45	B-143B
	2	RRA-591V	45	B-143B
	1	RRA-591Y	65	B-143B
	1/0	RRH-592C	90	B-144C
	2/0	RRH-592G	90	B-144C
	3/0	RRH-592L	115	B-144A
	4/0	RRH-592Q	115	B-144A
14	1/0	RRH-602C	90	B-144C
	2/0	RRH-602G	90	B-144C
	3/0	RRH-602L	115	B-144A
	4/0	RRH-602Q	115	B-144A
18	1/0	RRH-612C	90	B-144C
	2/0	RRH-612G	90	B-144C
	3/0	RRH-612L	115	B-144A
	4/0	RRH-612Q	115	B-144A

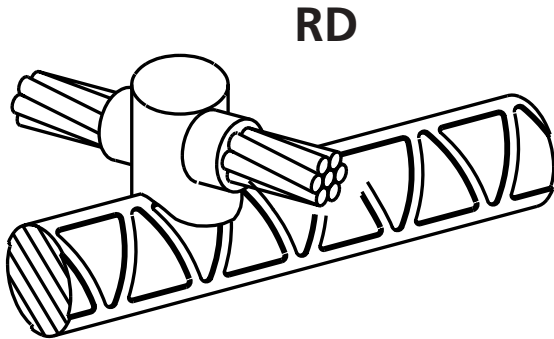

CABLE TO REBAR

- X connection horizontal cable to horizontal rebar.
- Rebar material characteristics and location of weld must be considered when selecting connections to rebar.
- Concentric stranded copper cable is listed.
- **Bold letter** in mold part number is the price key.

REQUIRED TOOLS

Handle Clamps **L160** for **C** Price Key Molds
Mold frame included with **M** and **H** Price Key Molds

Flint Ignitor **T320** (Included with handle clamp and frames but also available separately)

Packing One required for each connection - see tables which follow

SUGGESTED TOOLS

Cable Cleaning Brush	T313 or T314
Slag Removal Spade	B136A or B136B
Mold Cleaning Brush	T394
File	T329
Torch Head	T111

ACCESSORIES

See Section A

REBAR SIZE	CABLE SIZE	MOLD PART NO.	WELD METAL	PACKING PART NO.
3	6*	RDC -511H	65	B-141A
	4	RDC -511L	65	B-141A
	2 SOL	RDC -511T	90	B-141A
	2	RDC -511V	90	B-141A
	1	RDC -511Y	90	B-141A
	1/0	RDM -512C	115	B-141A
	2/0	RDM -512G	115	B-141A
	3/0	RDM -512L	150	B-141A
	4/0	RDM -512Q	150	B-141A
	4	6*	RDC -521H	65
4		RDC -521L	65	B-141A
2 SOL		RDC -521T	90	B-141A
2		RDC -521V	90	B-141A
1		RDM -521Y	90	B-141A
1/0		RDM -522C	115	B-141A
2/0		RDM -522G	115	B-141A
3/0		RDM -522L	150	B-141A
4/0		RDM -522Q	150	B-141A

*Requires B112 sleeve (2 per connection)

REBAR SIZE	CABLE SIZE	MOLD PART NO.	WELD METAL	PACKING PART NO.
5	6*	RDC -531H	65	B-141A
	4	RDC -531L	65	B-141A
	2 SOL	RDC -531T	90	B-141A
	2	RDC -531V	90	B-141A
	1	RDM -531Y	90	B-141A
	1/0	RDM -532C	115	B-141A
	2/0	RDM -532G	115	B-141A
	3/0	RDM -532L	150	B-141A
	4/0	RDM -532Q	150	B-141A
	6	6*	RDH -541H	65
4		RDH -541L	65	B-144C
2 SOL		RDH -541T	90	B-141C
2		RDH -541V	90	B-144C
1		RDH -541Y	90	B-144C
1/0		RDH -542C	115	B-144C
2/0		RDH -542G	115	B-144C
3/0		RDH -542L	150	B-144A
4/0		RDH -542Q	150	B-144A

*Requires B112 sleeve (2 per connection)



REBAR SIZE	CABLE SIZE	MOLD PART NO.	WELD METAL	PACKING PART NO.
7	4	RDH-551L	65	B-144C
	2 SOL	RDH-551T	90	B-144C
	2	RDH-551V	90	B-144C
	1	RDH-551Y	90	B-144C
	1/0	RDH-552C	115	B-144C
	2/0	RDH-552G	115	B-144C
	3/0	RDH-552L	150	B-144A
	4/0	RDH-552Q	150	B-144A
8	2 SOL	RDH-561T	90	B-144C
	2	RDH-561V	90	B-144C
	1	RDH-561Y	90	B-144C
	1/0	RDH-562C	115	B-144C
	2/0	RDH-562G	115	B-144C
	3/0	RDH-562L	150	B-144A
	4/0	RDH-562Q	150	B-144A
9	2 SOL	RDH-571T	90	B-144C
	2	RDH-571V	90	B-144C
	1	RDH-571Y	90	B-144C
	1/0	RDH-572C	115	B-144C
	2/0	RDH-572G	115	B-144C
	3/0	RDH-572L	150	B-144A
	4/0	RDH-572Q	150	B-144A

REBAR SIZE	CABLE SIZE	MOLD PART NO.	WELD METAL	PACKING PART NO.
10	2 SOL	RDH-581T	90	B-144C
	2	RDH-581V	90	B-144C
	1	RDH-581Y	90	B-144C
	1/0	RDH-582C	115	B-144C
	2/0	RDH-582G	115	B-144C
	3/0	RDH-582L	150	B-144A
	4/0	RDH-582Q	150	B-144A
11	2 SOL	RDH-591T	90	B-144C
	2	RDH-591V	90	B-144C
	1	RDH-591Y	90	B-144C
	1/0	RDH-592C	115	B-144C
	2/0	RDH-592G	115	B-144C
	3/0	RDH-592L	150	B-144A
	4/0	RDH-592Q	150	B-144A
14	1/0	RDH-602C	115	B-144C
	2/0	RDH-602G	115	B-144C
	3/0	RDH-602L	150	B-144A
	4/0	RDH-602Q	150	B-144A
18	1/0	RDH-612C	115	B-144C
	2/0	RDH-612G	115	B-144C
	3/0	RDH-612L	150	B-144A
	4/0	RDH-612Q	150	B-144A

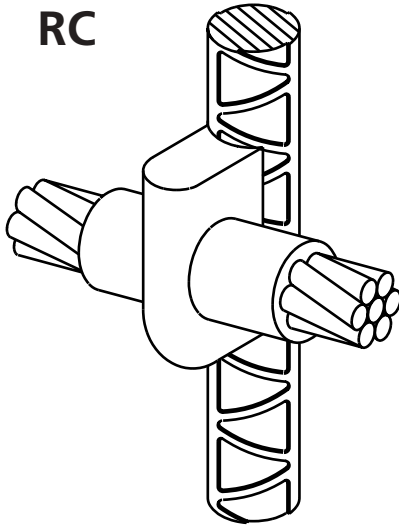

CABLE TO REBAR

- Through connection horizontal cable to vertical rebar.
- Rebar material characteristics and location of weld must be considered when selecting connections to rebar.
- Concentric stranded copper cable is listed.
- **Bold letter** in mold part number is the price key.

REQUIRED TOOLS

- Handle Clamps** **L160** for *E Price Key Molds*
Frame included with E Price Key Molds
- Flint Ignitor** **T320** (*Included with handle clamp and frame but also available separately*)
- Packing** *One required for each connection - see tables which follow*

SUGGESTED TOOLS

- Cable Cleaning Brush T313 or T314
 Slag Removal Spade B136A or B136B
 Mold Cleaning Brush T394
 File T329
 Torch Head T111

ACCESSORIES

See Section A

REBAR SIZE	CABLE SIZE	MOLD PART NO.	WELD METAL	PACKING PART NO.
3	6*	RCE -511H	90	B-140A
	4	RCE -511L	90	B-140A
	2 SOL	RCE -511T	90	B-140A
	2	RCE -511V	90	B-140A
	1	RCE -511Y	115	B-140A
	1/0	RCE -512C	115	B-140A
	2/0	RCE -512G	115	B-140A
	3/0	RCE -512L	150	B-140A
	4/0	RCE -512Q	150	B-140A
	4	6*	RCE -521H	90
4		RCE -521L	90	B-140A
2 SOL		RCE -521T	90	B-140A
2		RCE -521V	90	B-140A
1		RCE -521Y	115	B-140A
1/0		RCE -522C	115	B-140A
2/0		RCE -522G	115	B-140A
3/0		RCE -522L	150	B-140A
4/0		RCE -522Q	150	B-140A

*Requires B112 sleeve (2 per connection)

REBAR SIZE	CABLE SIZE	MOLD PART NO.	WELD METAL	PACKING PART NO.
5	6*	RCE -531H	90	B-140A
	4	RCE -531L	90	B-140A
	2 SOL	RCE -531T	90	B-140A
	2	RCE -531V	90	B-140A
	1	RCE -531Y	115	B-140A
	1/0	RCE -532C	115	B-140A
	2/0	RCE -532G	115	B-140A
	3/0	RCE -532L	150	B-140A
	4/0	RCE -532Q	150	B-140A
	6	6*	RCE -541H	90
4		RCE -541L	90	B-144B
2 SOL		RCE -541T	90	B-140B
2		RCE -541V	90	B-144B
1		RCE -541Y	115	B-144B
1/0		RCE -542C	115	B-144B
2/0		RCE -542G	115	B-144B
3/0		RCE -542L	150	B-144B
4/0		RCE -542Q	150	B-144B

*Requires B112 sleeve (2 per connection)



REBAR SIZE	CABLE SIZE	MOLD PART NO.	WELD METAL	PACKING PART NO.
7	4	RCE-551L	90	B-144B
	2 SOL	RCE-551T	90	B-144B
	2	RCE-551V	90	B-144B
	1	RCE-551Y	115	B-144B
	1/0	RCE-552C	115	B-144B
	2/0	RCE-552G	115	B-144B
	3/0	RCE-552L	150	B-144B
8	4/0	RCE-552Q	150	B-144B
	2 SOL	RCE-561T	90	B-144B
	2	RCE-561V	90	B-144B
	1	RCE-561Y	115	B-144B
	1/0	RCE-562C	115	B-144B
	2/0	RCE-562G	115	B-144B
	3/0	RCE-562L	150	B-144B
9	4/0	RCE-562Q	150	B-144B
	2 SOL	RCE-571T	90	B-144B
	2	RCE-571V	90	B-144B
	1	RCE-571Y	115	B-144B
	1/0	RCE-572C	115	B-144B
	2/0	RCE-572G	115	B-144B
	3/0	RCE-572L	150	B-144B
4/0	RCE-572Q	150	B-144B	

REBAR SIZE	CABLE SIZE	MOLD PART NO.	WELD METAL	PACKING PART NO.
10	2 SOL	RCE-581T	90	B-144B
	2	RCE-581V	90	B-144B
	1	RCE-581Y	115	B-144B
	1/0	RCE-582C	115	B-144B
	2/0	RCE-582G	115	B-144B
	3/0	RCE-582L	150	B-144B
	4/0	RCE-582Q	150	B-144B
11	2 SOL	RCE-591T	90	B-144B
	2	RCE-591V	90	B-144B
	1	RCE-591Y	115	B-144B
	1/0	RCE-592C	115	B-144B
	2/0	RCE-592G	115	B-144B
	3/0	RCE-592L	150	B-144B
	4/0	RCE-592Q	150	B-144B
14	1/0	RCE-602C	115	B-144B
	2/0	RCE-602G	115	B-144B
	3/0	RCE-602L	150	B-144B
	4/0	RCE-602Q	150	B-144B
18	1/0	RCE-612C	115	B-144B
	2/0	RCE-612G	115	B-144B
	3/0	RCE-612L	150	B-144B
	4/0	RCE-612Q	150	B-144B

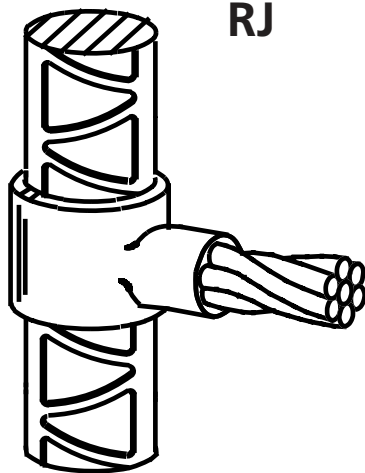

CABLE TO REBAR

- Tee connection horizontal cable tap to vertical rebar.
- Rebar material characteristics and location of weld must be considered when selecting connections to rebar.
- Concentric stranded copper cable is listed.
- **Bold letter** in mold part number is the price key.

REQUIRED TOOLS

Handle Clamps **L160** for **C** and **E** Price Key Molds
Frame included with **E** Price Key Molds

Flint Ignitor **T320** (Included with handle clamp and frames but also available separately)

Packing One required for each connection - see tables which follow

SUGGESTED TOOLS

Cable Cleaning Brush	T313 or T314
Slag Removal Spade	B136A or B136B
Mold Cleaning Brush	T394
File	T329
Torch Head	T111

ACCESSORIES

See Section A

REBAR SIZE	CABLE SIZE	MOLD PART NO.	WELD METAL	PACKING PART NO.
3	6*	RJC -511H	45	B-140A
	4	RJC -511L	65	B-140A
	2 SOL	RJC -511T	65	B-140A
	2	RJC -511V	65	B-140A
	1	RJC -511Y	90	B-140A
	1/0	RJC -512C	115	B-140A
	2/0	RJC -512G	115	B-140A
	3/0	RJC -512L	150	B-140A
	4/0	RJC -512Q	150	B-140A
	4	6*	RJC -521H	45
4		RJC -521L	65	B-140A
2 SOL		RJC -521T	65	B-140A
2		RJC -521V	65	B-140A
1		RJC -521Y	90	B-140A
1/0		RJC -522C	115	B-140A
2/0		RJC -522G	115	B-140A
3/0		RJC -522L	150	B-140A
4/0		RJC -522Q	150	B-140A

*Requires B112 sleeve (2 per connection)

REBAR SIZE	CABLE SIZE	MOLD PART NO.	WELD METAL	PACKING PART NO.
5	6*	RJC -531H	45	B-140A
	4	RJC -531L	65	B-140A
	2 SOL	RJC -531T	65	B-140A
	2	RJC -531V	65	B-140A
	1	RJC -531Y	90	B-140A
	1/0	RJC -532C	115	B-140A
	2/0	RJC -532G	115	B-140A
	3/0	RJC -532L	150	B-140A
	4/0	RJC -532Q	150	B-140A
	6	6*	RJC -541H	45
4		RJC -541L	65	B-140A
2 SOL		RJC -541T	65	B-140A
2		RJC -541V	65	B-140A
1		RJC -541Y	90	B-140B
1/0		RJC -542C	115	B-140B
2/0		RJC -542G	115	B-140B
3/0		RJC -542L	150	B-140B
4/0		RJC -542Q	150	B-140B

*Requires B112 sleeve (2 per connection)







REBAR SIZE	CABLE SIZE	MOLD PART NO.	WELD METAL	PACKING PART NO.	
7	4	RJE-551L	65	B-144A	
	2 SOL	RJE-551T	65	B-144A	
	2	RJE-551V	65	B-144A	
	1	RJE-551Y	90	B-144A	
	1/0	RJE-552C	115	B-144B	
	2/0	RJE-552G	115	B-144B	
	3/0	RJE-552L	150	B-144B	
	4/0	RJE-552Q	150	B-144B	
	8	2 SOL	RJE-561T	65	B-144A
		2	RJE-561V	65	B-144A
1		RJE-561Y	90	B-144A	
1/0		RJE-562C	115	B-144B	
2/0		RJE-562G	115	B-144B	
3/0		RJE-562L	150	B-144B	
4/0		RJE-562Q	150	B-144B	
9		2 SOL	RJE-571T	65	B-144A
	2	RJE-571V	65	B-144A	
	1	RJE-571Y	90	B-144A	
	1/0	RJE-572C	115	B-144B	
	2/0	RJE-572G	115	B-144B	
	3/0	RJE-572L	150	B-144B	
	4/0	RJE-572Q	150	B-144B	

REBAR SIZE	CABLE SIZE	MOLD PART NO.	WELD METAL	PACKING PART NO.	
10	2 SOL	RJE-581T	65	B-144A	
	2	RJE-581V	65	B-144A	
	1	RJE-581Y	90	B-144A	
	1/0	RJE-582C	115	B-144B	
	2/0	RJE-582G	115	B-144B	
	3/0	RJE-582L	150	B-144E	
	4/0	RJE-582Q	150	B-144E	
	11	2 SOL	RJE-591T	65	B-144A
		2	RJE-591V	65	B-144A
		1	RJE-591Y	90	B-144A
1/0		RJE-592C	115	B-144B	
2/0		RJE-592G	115	B-144B	
3/0		RJE-592L	150	B-144E	
4/0		RJE-592Q	150	B-144E	
14		1/0	RJE-602C	115	B-144B
	2/0	RJE-602G	115	B-144B	
	3/0	RJE-602L	150	B-144E	
	4/0	RJE-602Q	150	B-144E	
18	1/0	RJE-612C	115	B-144B	
	2/0	RJE-612G	115	B-144B	
	3/0	RJE-612L	150	B-144E	
	4/0	RJE-612Q	150	B-144E	

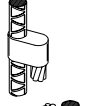
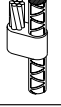
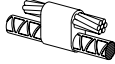
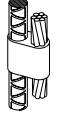
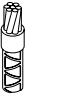
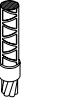
OTHER CABLE TO REBAR CONNECTIONS

The connections shown below are for use only where connections shown in this catalog are not suitable.

NAME	TYPE		EASE	SPLIT
EII	DT		2	V
Parallel tap	DR		2	V
	RV		2	V
Parallel thru	RT		2	V
	RW		2	V
Splice	RE		2	V
	RF		2	V
	RG		1	V
	SF		2	V
	SR		1	V

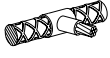
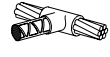
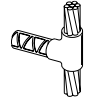
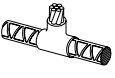
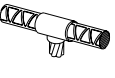
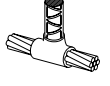
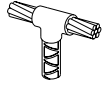
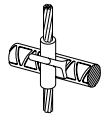
NAME	TYPE		EASE	SPLIT
Tee	RH		1	*
	RK		1	*
	RL		2	V
	RM		2	V
	RN		2	V
	RP		2	V
	RQ		2	V
X	XJ		1	*



ST
Page 2

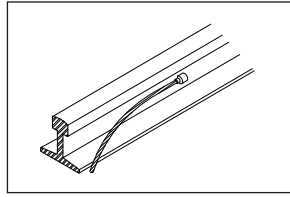

W
Page 3

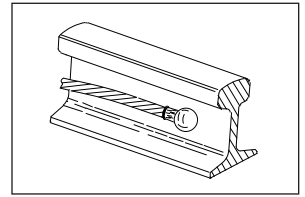

TP
Page 2

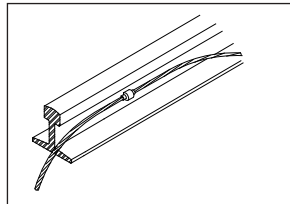

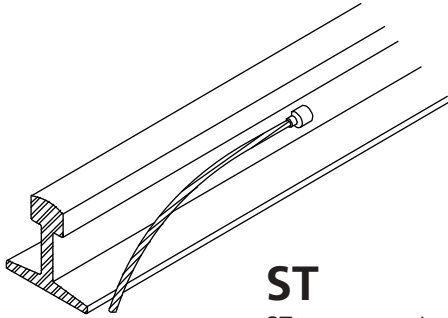

ST

ST type connections - specify RH (right hand) or LH (left hand). RH supplied if not specified.
RH shown.

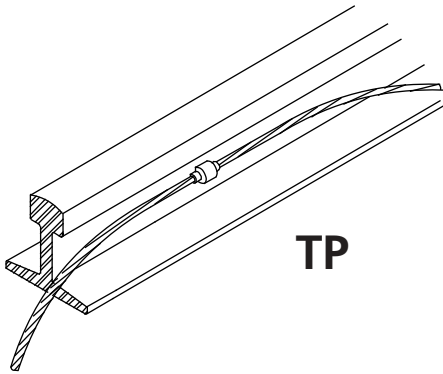

TP

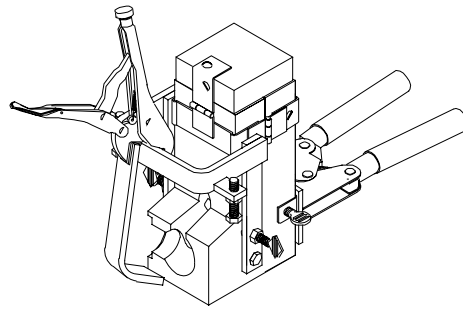

CABLE TO RAIL

- Connections for grounding cable to the rail web of 85 lb. to 140 lb. standard rails
- Concentric stranded copper cable is listed.
- Contact ERICO for crane or girder rail applications.
- Note: Rail materials characteristics, use and locations of weld should be considered when selecting connections to a rail.
- For cable sizes not listed, multiple connections using smaller cables are suggested.
- **Bold letter** in mold part number is the price key.

REQUIRED TOOLS

Handle Clamps **L160** for R Price Key Molds

Rail Clamp **C120J** (requires L160 handle clamp)

Flint Ignitor **T320** (Included with handle clamp and Rail Clamp but also available separately)

SUGGESTED TOOLS

Cable Cleaning Brush	T313
Slag Removal Spade	B136A or B136B
Mold Cleaning Brush	T394
Rasp	T321
Torch Head	T111

ACCESSORIES

See Section A

TYPE ST		
CABLE SIZE	MOLD PART NO.	WELD METAL
4	STR -1L	65F80
2	STR -1V	65F80
1	STR -1Y	65F80
1/0	STR -2C	90F80
2/0	STR -2G	90F80
4/0	STR -2Q	115F80

TYPE TP		
CABLE SIZE	MOLD PART NO.	WELD METAL
4	TPR -1L	90F80
2	TPR -1V	90F80
1	TPR -1Y	90F80
1/0	TPR -2C	115F80
2/0	TPR -2G	115F80
4/0	TPR -2Q	150F80

W

Type W - RH Shown

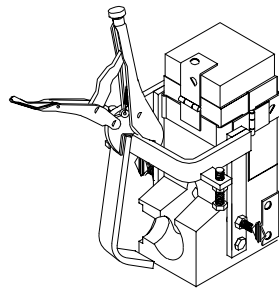
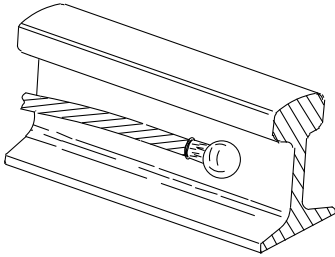

WEB WELDER

CABLE TO RAIL AND STRUCTURES

- Type W Bonds are for bonding and grounding of standard rails. These bonds are welded to the web of rail sections 85 lb. to 140 lb.
- Mold frame includes adjusting screw to position bond at neutral axis of rail where stresses are minimal.
- Contact ERICO for crane and girder rails.
- Concentric stranded copper cable is listed.
- NOTE: Rail materials characteristics, use and location of weld should be considered when selecting connections to a rail.

REQUIRED TOOLS

Flint Ignitor **T320** (Included with welder but also available separately)

SUGGESTED TOOLS

Cable Cleaning Brush	T313
Slag Removal Spade	B136A or B136B
Mold Cleaning Brush	T394
Rasp	T321
Torch Head	T111

ACCESSORIES

See Section A

HOW TO ORDER FACTORY MADE BONDS

1. Order bond giving bond length in inches.
 - a. Joint bonds must be at least 10 inches longer than rail angle bar.
 - b. Stub-End bonds must be 9 inches minimum.

Specify right hand (RH) or left hand (LH).
2. Order welder (mold with frame and rail clamp) by right hand and/or left hand. Includes flint ignitor.
3. Replacement molds and weld metal are furnished with bonds as follows:

Joint bonds: Two weld metals per bond, plus one each right and left hand mold for every 80 bonds.

Stub-End bonds: One weld metal per bond, plus one mold only for every 80 bonds.

FACTORY MADE					
CABLE SIZE	JOINT BOND	STUB END BOND	WEB WELDER PART NUMBER	MOLD ONLY PART NUMBER	WELD METAL
1/0	W12C-(length)	W32C-(length)	WRS-2C-RH (-LH)	WRS-2C-RHM (-LHM)	65F80
2/0	W12G-(length)	W32G-(length)	WRS-2G-RH (-LH)	WRS-2G-RHM (-LHM)	90F80
4/0	W12Q-(length)	W32Q-(length)	WRS-2Q-RH (-LH)	WRS-2Q-RHM (-LHM)	90F80

HOW TO ORDER FIELD MADE BONDS

1. One sleeve per cable end to be welded to rail.
2. One or more hammer die per job.
3. One welder for each welding crew. Right hand and/or left hand.
4. One mold for every 50 to 80 bonds after first 50. Right hand and/or left hand.
5. One weld metal per cable end to be welded.

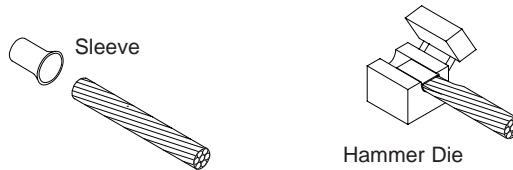

FIELD MADE					
CABLE SIZE	WEB WELDER PART NUMBER	MOLD ONLY PART NUMBER	SLEEVE	HAMMER DIE	WELD METAL
1/0	WRS-05-RH (-LH)	WRS-05-RHM (-LHM)	S05F	WD80	65F80
2/0	WRS-03-RH (-LH)	WRS-03-RHM (-LHM)	S03F	WD84	90F80
4/0	WRS-01-RH (-LH)	WRS-01-RHM (-LHM)	S01F	WD82	90F80

NOTES...



CAST GROUND PLATES, AIRCRAFT GROUNDING RECEPTACLES

SECTION 10

HV
Page 2

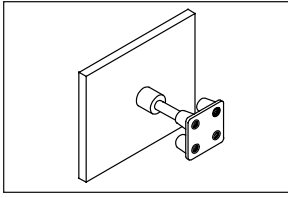

**B165/
B165R**
Page 4

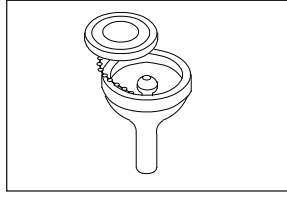

GB
Page 6

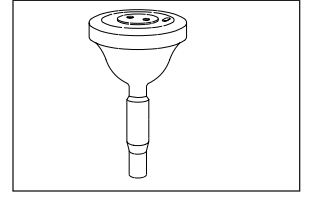

HV/VF
Page 2

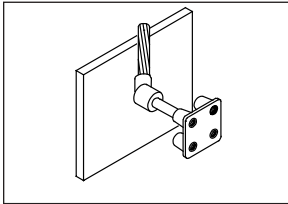

**B166/
B167**
Page 4

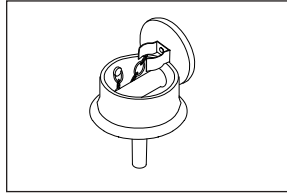

RA
Page 7

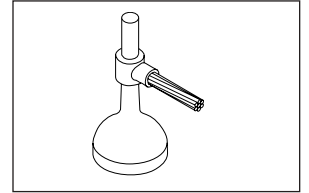

HV/VE
Page 2

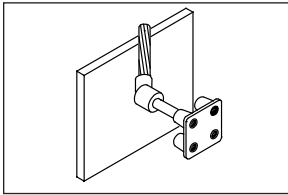

**Cast
Ground
Plate
Assemblies**
Page 5

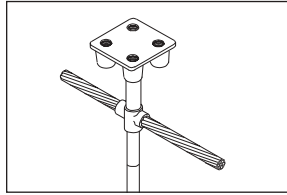

RB
Page 7

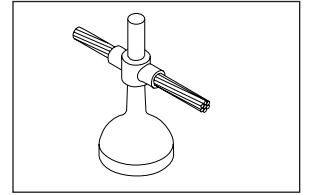

**Cast
Ground
Plate**
Page 3

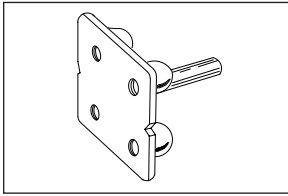

GB/GR
Page 6

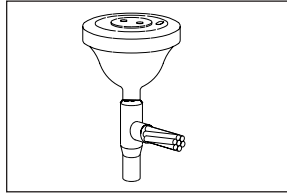

HX
Page 8

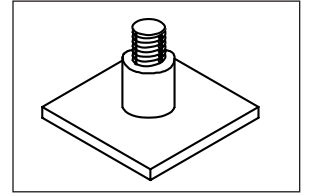

**Cast
Ground
Plate**
Page 3

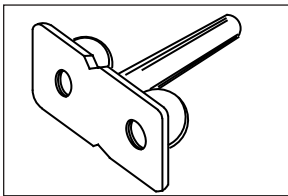

GB/GT
Page 6

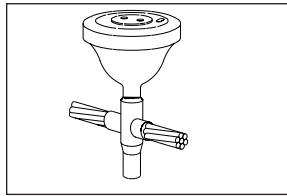

HV
Page 8

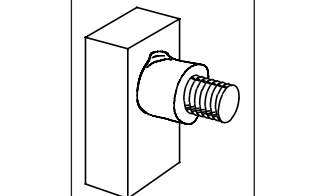

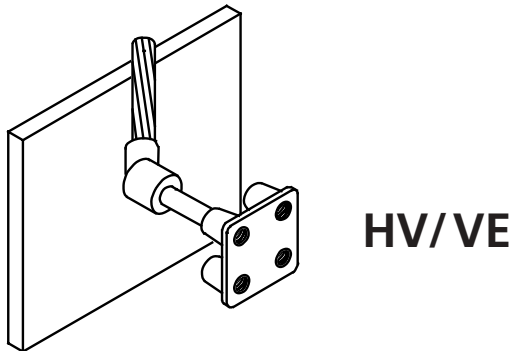
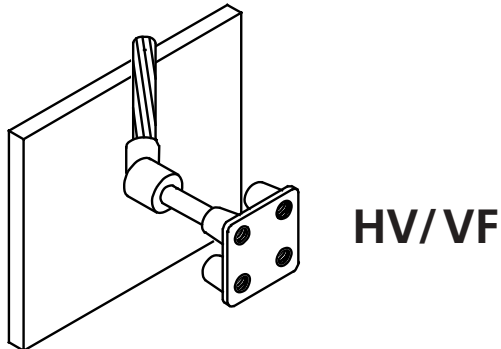
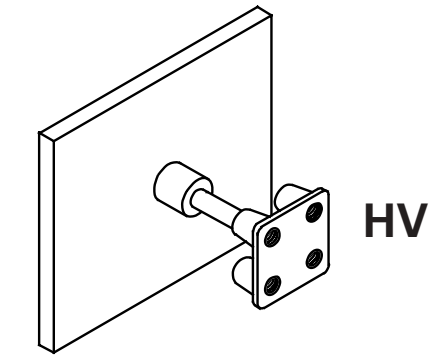

CAST GROUND PLATE CONNECTIONS TO STRUCTURES

- CADWELD cast ground plates used in concrete structures offer convenient ground system connection points. These ground points are used for equipment, machinery and structure grounding after completion of the concrete work.
- For structural reasons, cast ground plates should always be encased in concrete.
- For B-161-2Q, B-162-2Q or B-164-2Q Cast Ground Plates Only.
- Concentric stranded copper cable is listed.
- Contact ERICO for other Ground Plates.
- **Bold letter** in mold part number is the price key.

REQUIRED TOOLS

Handle Clamps **L160** for **C** and **R** Price Key Molds
L159 for **F** Price Key Molds

Flint Ignitor **T320** (Included with handle clamp or Frame but also available separately)

SUGGESTED TOOLS

Slag Removal Spade	B136A or B136B
Mold Cleaning Brush	T394
Rasp	T321
Torch Head	T111

ACCESSORIES

See Section A

TYPE HV				
GROUND PLATE	MOLD PART NO.	WELD METAL		
B-161-2Q B-162-2Q B-164-2Q	HVC-2Q-001	150		
B-161-3Q B-164-3Q			HVC-3Q-002	200

CABLE SIZE	TYPE HV-VF		TYPE HV-VE	
	MOLD PART NO.	WELD METAL	MOLD PART NO.	WELD METAL
1/0	HVR-2Q-004	200	HVR-2Q-008	200
2/0	HVR-2Q-003	200	HVR-2Q-013	200
3/0	HVR-2Q-005	250	HVR-2Q-014	250
4/0	HVR-2Q-002	250	HVR-2Q-009	250
250	HVR-2Q-010	250	HVR-2Q-015	250
300	HVR-2Q-011	2-150	HVR-2Q-016	2-150
350	HVF-2Q-012	2-200	HVR-2Q-017	2-150
500	HVF-2Q-007	500	HVF-2Q-006	2-200



CADWELD CAST GROUND PLATES

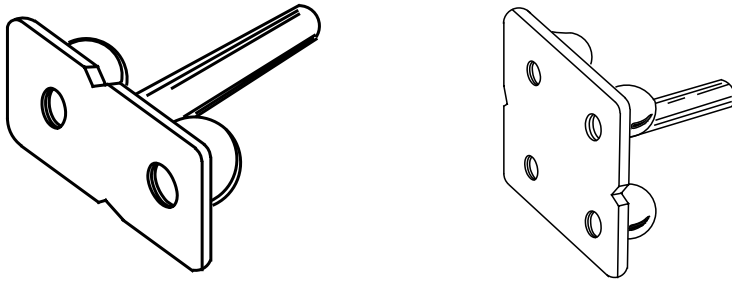

CADWELD CAST GROUND PLATES

CADWELD ground plates used in concrete structures offer convenient ground system connection points. These ground points are used for equipment, machinery and structure grounding after completion of the concrete work.

The castings are made from a copper alloy. CADWELD ground plate connections result in current carrying capacity equal to that of the conductor or stud and cannot loosen or corrode.

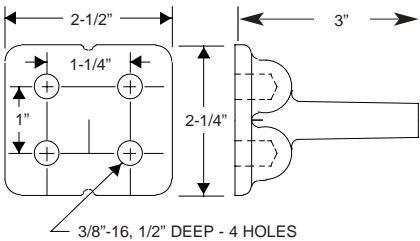

B161-2Q

With 4/0 Stud

B161-3Q

With 500 kcmil Stud

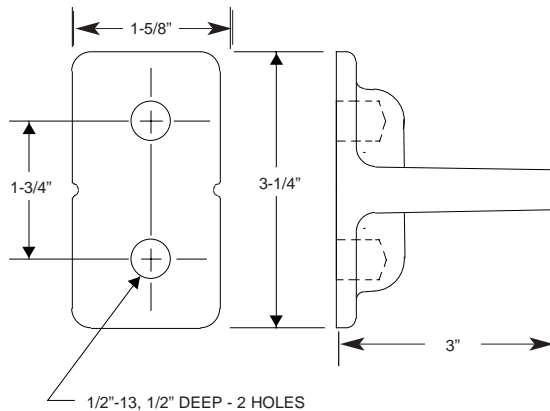

B162-2Q With 4/0 Stud

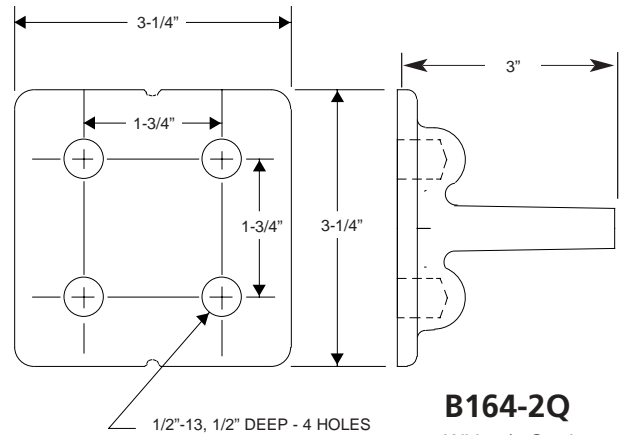

B164-2Q

With 4/0 Stud

B164-3Q

With 500 kcmil Stud

CAUTION:

Use only CADWELD cast ground plates. Other similar plates may be available which do not meet the strength requirements necessary. They may crack or break during installation.

Use a CADWELD Type TA or Type SS mold when connecting the CADWELD cast ground plate to the ground conductor. The cast ground plate stud size noted above fits the mold opening for a cable of the same size.

Example: Tee connection of 250 cable to B164-2Q (4/0 stud size), use mold TAC-2V2Q.

Splice connection of 250 cable to B164-2Q, use mold SSC-2Q2V.

AIRCRAFT GROUNDING RECEPTACLES

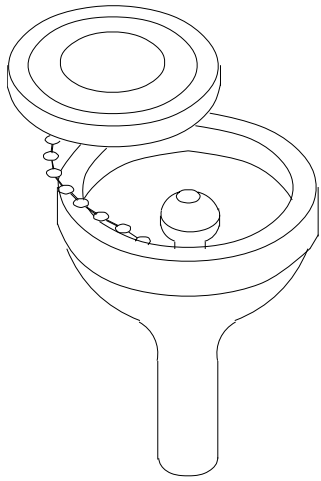

B165/B165R

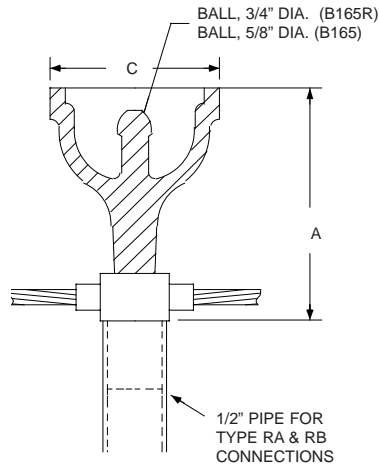

B165 and B165R

The B165 and B165R Grounding Receptacles are copper alloy castings intended for use in static grounding systems of aircraft refueling areas. They are easily connected to the grounding system conductor and/or ground rods with CADWELD connections. Designed for simple installation flush with the paved surface. The attachment point (3/4" ball) is an integral part of the casting on the B165 and is removable on the B165R.

RECEPTACLE	B165 and B165R
Depth A, Grade Level to Support	4-1/2
Diameter C, at Grade Level	2-3/4

SPECIAL NOTE

ERICO Aircraft Static Grounding Clamp B2617A can be used to connect to the B165, B165R and B166.

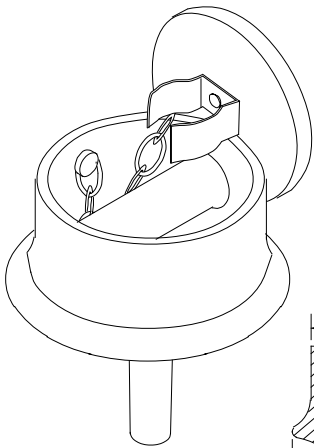

B166/B167

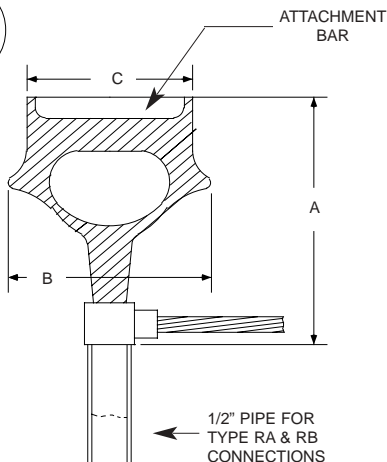

B166 and B167

The B166 and B167 Combination Tie-down and Static Grounding Receptacles are copper alloy castings. They are easily connected to the grounding system conductor with CADWELD connections. Designed for simple installation flush with the paved surface. The attachment bar (3/4" diameter on the B166 and 1-1/2" on the B167) is an integral part of the casting.

RECEPTACLE	B166	B167
Depth A, Grade Level to Support	6-1/4	7-1/4
Diameter B, Maximum Ring Size	4-3/4	6-1/2
Diameter C, at Grade Level	3-7/8	4-3/4

For assemblies using B166 and B167, contact ERICO.

SPECIAL NOTE

See pages 10-6 and 10-7 for CADWELD connections to aircraft grounding receptacles



CAST GROUND PLATE ASSEMBLIES

ORDERING INFORMATION

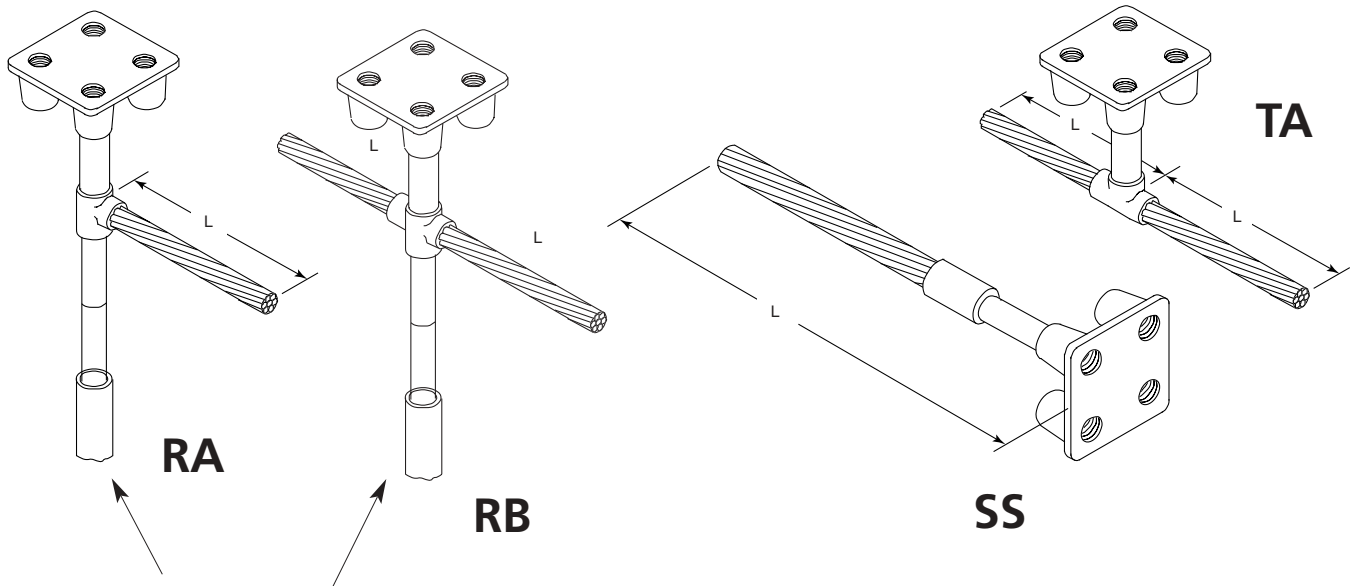

1/2" pipe can be used to support and position cast ground plate

GROUND PLATE	STYLE RA	STYLE RB	STYLE SS	STYLE TA
B1612Q	B530A"XL"	B531A"XL"	B532A"XL"	B533A"XL"
B1613Q	B530B"XL"	B531B"XL"	B532B"XL"	B533B"XL"
B1622Q	B530C"XL"	B531C"XL"	B532C"XL"	B533C"XL"
B1642Q	B530D"XL"	B531D"XL"	B532D"XL"	B533D"XL"
B1643Q	B530E"XL"	B531E"XL"	B532E"XL"	B533E"XL"

NOTE:	X (CONDUCTOR CODE)	EXAMPLE:
Add appropriate suffix:	#4 = 1L 4/0 = 2Q	B164-2Q Ground Plate
For "XL":	#2 = 1V 250 = 2V	4/0 Pigtail 4 feet long
X = Conductor Code	1/0 = 2C 350 = 3D	RA Style B530D2Q48
L = Length in inches	2/0 = 2G 500 = 3Q	

Conductor codes are for concentric strand copper cable.

AIRCRAFT GROUNDING RECEPTACLES

GB

Connection of grounding receptacle on ground rod.

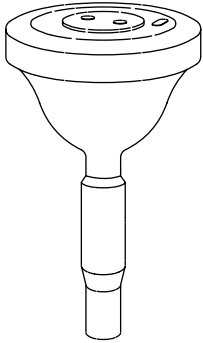

GB/GR

Connection of grounding receptacle, installed rod and cable tap.

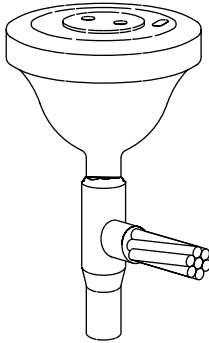

GB/GT

Connection of grounding receptacle, installed rod and through cable.

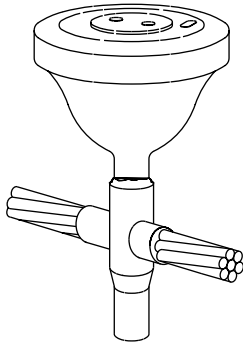

GROUNDING RECEPTACLES

- CADWELD splices for Grounding Receptacles B165 and B165R to the top of ground rods with or without cable connection for most sizes and types of ground rods, including copperclad and stainless, stainless clad or galvanized steel.
- Concentric stranded copper cable is listed.
- **Bold letter** in mold part number is the price key.
- For B166 and B167, contact ERICO.

REQUIRED TOOLS

Handle Clamps **L160** for *R* Price Key Molds
L159 for *F* and *J* Price Key Molds

Flint Ignitor **T320** (Included with handle clamp or frame but also available separately)

SUGGESTED TOOLS

Slag Removal Spade	B136A or B136B
Mold Cleaning Brush	T394
Cable Clamp	B265
Torch Head	T111

ACCESSORIES

See Section A

GROUND ROD SIZE	MOLD PART NO. TYPE GB		WELD METAL
	Copper Clad Rod Plain or Sectional	Steel Rod SS SS clad, Galv.	
5/8"	GB R -16R1	GB R -31R1	2-150
3/4"	GB R -18R1	GB R -33R1	2-150
1"	GB F -22R1	GB F -37R1	2-200

GROUND ROD SIZE	CABLE SIZE	MOLD PART NO. TYPE GB-GR		WELD METAL
		Copper Clad Rod Plain or Sectional	Steel Rod SS SS Clad, Galv.	
5/8"	1/0	GB J -GR162CR1	GB J -GR312CR1	2-200
	2/0	GB J -GR162GR1	GB J -GR312GR1	2-200
	3/0	GB J -GR162LR1	GB J -GR312LR1	2-200
	4/0	GB J -GR162QR1	GB J -GR312QR1	2-200
3/4"	1/0	GB J -GR182CR1	GB J -GR332CR1	2-200
	2/0	GB J -GR182GR1	GB J -GR332GR1	2-200
	3/0	GB J -GR182LR1	GB J -GR332LR1	2-200
	4/0	GB J -GR182QR1	GB J -GR332QR1	2-200
1"	1/0	GB J -GR222CR1	GB J -GR372CR1	500
	2/0	GB J -GR222GR1	GB J -GR372GR1	500
	3/0	GB J -GR222LR1	GB J -GR372LR1	500
	4/0	GB J -GR222QR1	GB J -GR372QR1	500

GROUND ROD SIZE	CABLE SIZE	MOLD PART NO. TYPE GB-GT		WELD METAL
		Copper Clad Rod Plain or Sectional	Steel Rod SS SS Clad, Galv.	
5/8"	1/0	GB J -GT162CR1	GB J -GT312CR1	2-200
	2/0	GB J -GT162GR1	GB J -GT312GR1	2-200
	3/0	GB J -GT162LR1	GB J -GT312LR1	2-200
	4/0	GB J -GT162QR1	GB J -GT312QR1	2-200
3/4"	1/0	GB J -GT182CR1	GB J -GT332CR1	2-200
	2/0	GB J -GT182GR1	GB J -GT332GR1	2-200
	3/0	GB J -GT182LR1	GB J -GT332LR1	2-200
	4/0	GB J -GT182QR1	GB J -GT332QR1	2-200
1"	1/0	GB J -GT222CR1	GB J -GT372CR1	500
	2/0	GB J -GT222GR1	GB J -GT372GR1	500
	3/0	GB J -GT222LR1	GB J -GT372LR1	500
	4/0	GB J -GT222QR1	GB J -GT372QR1	500



AIRCRAFT GROUNDING RECEPTACLES

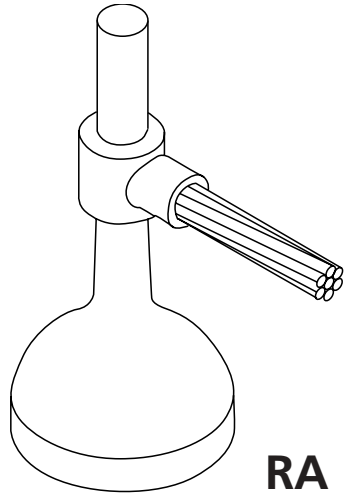

RA
Cable Tap

RA AND RB TYPES FOR AIRCRAFT GROUNDING

- CADWELD connection is made with the receptacle in the inverted position. The resulting riser fits inside a 1/2" pipe for proper elevation locating – see page 10-5.
- Concentric stranded copper cable is listed.
- **Bold letter** in mold part number is the price key.

REQUIRED TOOLS

Handle Clamps **L160** for **C** Price Key Molds

Flint Ignitor **T320** (Included with handle clamp or frame but also available separately)

SUGGESTED TOOLS

Slag Removal Spade	B136A or B136B
Mold Cleaning Brush	T394
File	T329
Torch Head	T111

ACCESSORIES

See Section A

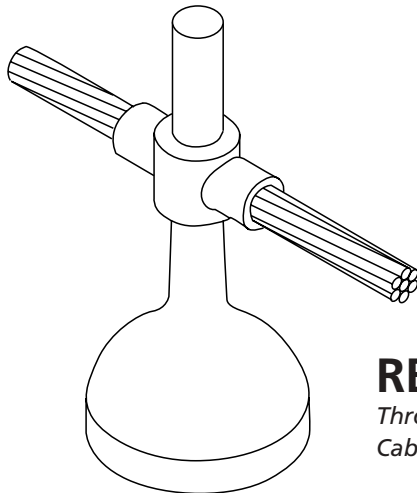

RB
Through Cable

TYPE RA Connections			TYPE RB Connections	
MOLD PART NO.	WELD METAL	CABLE SIZE	MOLD PART NO.	WELD METAL
RAC-1V	115	2	RBC-1V	115
RAC-1Y	115	1	RBC-1Y	115
RAC-2C	150	1/0	RBC-2C	150
RAC-2G	150	2/0	RBC-2G	150
RAC-2L	150	3/0	RBC-2L	200
RAC-2Q	150	4/0	RBC-2Q	200

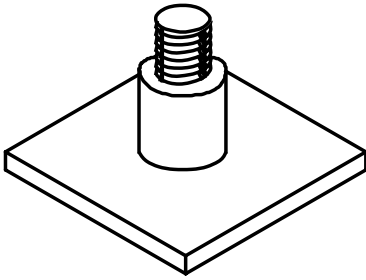

HX

Vertical stud to horizontal steel surface

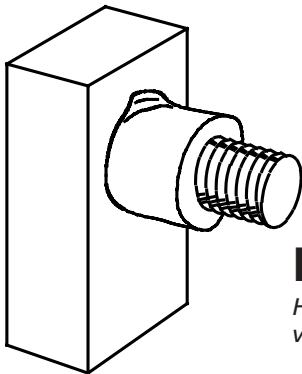

HV

Horizontal stud to vertical steel surface

COPPER AND STEEL STUDS

- Connections of copper or steel studs to steel surfaces. Copper studs on grounded structures provide a convenient point for attachment of temporary protective ground clamps.
- **Bold letter** in mold part number is the price key.

REQUIRED TOOLS

Handle Clamps **L160** for **C** Price Key Molds
L159 for **D** Price Key Molds

Flint Ignitor **T320** (Included with handle clamp or frame but also available separately)

SUGGESTED TOOLS

Slag Removal Spade	B136A or B136B
Mold Cleaning Brush	T394
Rasp	T321
Torch Head	T111

ACCESSORIES

See Section A

TYPE HX CONNECTIONS FOR STEEL SURFACES ONLY				
STEEL STUDS ONLY				
STUD SIZE	MOLD PART NO.	TYPE HX WELD DIMENSIONS		WELD METAL
		A (thickness)	B (diameter)	
1/4"	HXC-10	3/8"	3/4"	25
5/16"	HXC-11	3/8"	3/4"	25
3/8"	HXC-12	9/16"	7/8"	45
1/2"	HXC-14	5/8"	1-1/16"	65
3/4"	HXC-18	5/8"	1-1/2"	150
1"	HXC-22	15/16"	1-5/8"	2-150

TYPE HV CONNECTIONS FOR STEEL SURFACES ONLY				
STEEL STUDS ONLY				
STUD SIZE	MOLD PART NO.	TYPE HX WELD DIMENSIONS		WELD METAL
		A (thickness)	B (diameter)	
1/4"	HVC-10	3/8"	3/4"	25
5/16"	HVC-11	3/8"	3/4"	25
3/8"	HVC-12	9/16"	7/8"	45
1/2"	HVC-14	5/8"	1-1/16"	65
3/4"	HVC-18	5/8"	1-1/2"	150
1"	HVC-22	15/16"	1-5/8"	250

TYPE HV CONNECTIONS FOR STEEL SURFACES ONLY		
COPPER* STUDS ONLY		
STUD SIZE	MOLD PART NO.	WELD METAL
1/2"	HVC-14CU	115
5/8"	HVC-31CU	150
3/4"	HVC-33CU	250
7/8"	HVD-35CU	2-150
1"	HVD-37CU	2-200

*or silicon bronze



ABOUT HEAVY DUTY ELECTRICAL CONNECTIONS for stranded concentric copper conductors.

Heavy Duty connections were developed to be used on reclaimed cable. Heavy Duty connections use a larger size connection cavity in the mold and a larger size weld metal than the equivalent standard connections.

The larger size weld metal supplies extra BTU's (but not a higher temperature) to melt the heavy oxide coating on the conductor and to overcome severe field conditions.

Heavy Duty connections offer the following advantages:

- Eliminates cutting the run conductor on certain types of connections.
- Reduces cable cleaning requirements for old or reclaimed cable.
- Increases reliability under adverse field conditions.

NOTE: The increased size of weld metal raises costs compared to connections shown in sections 1 through 10.

NOTES...



OTHER CONNECTIONS





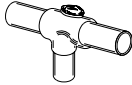





COPPER TUBE TO GROUND RODS

The connections shown below are for use only where connections shown in this catalog are not suitable.

NAME	TYPE		EASE	SPLIT	NAME	TYPE		EASE	SPLIT
EII	FT		1	V	Tee	FV		1	V



COPPER TUBE TO COPPER TUBE

The connections shown below are for use only where connections shown in this catalog are not suitable.

NAME	TYPE		EASE	SPLIT	NAME	TYPE		EASE	SPLIT
EII	FK		1	*	Tee	FF		1	*
	FL		3	V		FG		2	V
	FM		2	V		FH		3	V
Splice	FD		1	V		FJ		3	V
	FE		3	V	X	XT		4	*



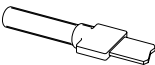
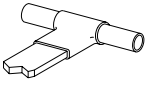
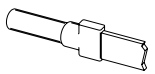
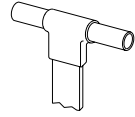







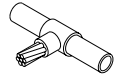

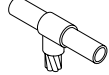
COPPER TUBE TO BUSBARS OR LUGS

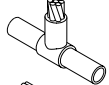
The connections shown below are for use only where connections shown in this catalog are not suitable.

NAME	TYPE		EASE	SPLIT	NAME	TYPE		EASE	SPLIT
Splice	FN		1	*	Tee	FR		2	*
	FP		1	V		FS		1	V
Tee	EW		2	V					

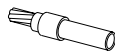



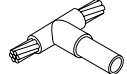

CABLE TO COPPER TUBE

The connections shown below are for use only where connections shown in this catalog are not suitable.

NAME	TYPE		EASE	SPLIT	NAME	TYPE		EASE	SPLIT
EII	DP		1	*	Tee	ML		1	*
	MV		2	V		MM		3	*
	MW		3	V		MP		3	*
	MX		2	V		MQ		3	*
	MY		3	V		MR		3	*
Splice	MH		1	V		MS		3	*
	MJ		3	V		MT		3	*
	MK		3	V		NA		1	*

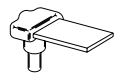
BUSBAR TO GROUND RODS

The connections shown below are for use only where connections shown in this catalog are not suitable.

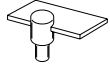
NAME	TYPE		EASE	SPLIT	NAME	TYPE		EASE	SPLIT
EII	CL		1	V	Splice	CS		3	V
Tee	CN		1	V		Tee	CQ		3
	CM		3	V	CR			1	V
	CP		2	V					



SAFETY FIRST
 Safety Glasses and Gloves2

CADWELD WELD METAL2

CADWELD MOLDS2

ADAPTING MOLDS TO FIT CONDUCTORS
 Wrap Sleeves3
 Adapter Sleeves3
 Packing3
 CADWELD Mold Sealer3
 CADWELD Sleeve Kit3

CABLE AND WORK SURFACE PREPARATION
 Cable Cleaning Brushes4
 Cable Clamps4
 Rasp4
 Surefire™ Torch Head5
 Galvanizing Touch Up5

MOLD CARE AND USE
 Mold Cleaning Brushes6
 Slag Removal Spades6
 Disks6
 Disk Kit6
 Wear Plates7
 Split Crucible7

MOLD FASTENING AND MOUNTING
 Handle Clamps8
 Vertical Surface Mold Support8
 Chain Support Handle Clamps8
 Magnetic Handle Clamps9
 Fence Fabric Attachment Assembly9

GROUND ROD SPECIALTY TOOLS
 Ground Rod Driving Sleeves10
 Ground Rod Splice Clamp10
 ERITECH Ground Rod Drivers10

OTHER TOOLS
 Flint Ignitor10
 Flint Ignitor Extension10
 Ceramic Blanket11
 File11
 Pliers11
 Screwdriver11
 Welding Tray11
 Tool Box11
 Tool Kits11
 Tool Tray11
 Ground System Testers EST Series12
 Practical Guide to Electrical Grounding12

SAFETY FIRST

ERICO recommends SAFETY FIRST when making CADWELD Connections as you should consider with all tasks. We offer the following safety equipment. We recommend gloves and glasses as shown.

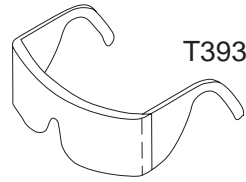

T393

Safety Glasses

These glasses may be worn separately or over prescription glasses.

Gloves

Heavy canvas gloves with leather palms.

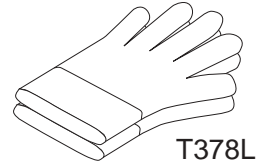

T378L

CADWELD WELD METAL

CADWELD Weld Metal is a mixture of copper oxide and aluminum, packaged by size in plastic tubes. Each tube contains the starting material at the bottom of the plastic tube, with the Weld Metal on top. These materials are not explosive and not subject to spontaneous ignition. These containers are packaged in boxes along with metal disks. Each weld uses one disk.

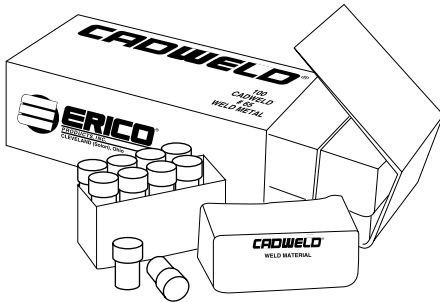

Five types of CADWELD Weld Metal are used for grounding connections:

1. F20 or standard Weld Metal is used for all grounding connections with the exception of those to cast iron or to load bearing rail. The Standard Weld Metal containers have clear (or natural) caps. Standard Weld Metal is also used with most FX molds.
2. XL Weld Metal is used with EXOLON molds. EXOLON Weld Metal containers have white caps.
3. XF-19 Alloy Weld Metal is used for all connections to cast iron such as Type HB and others. XF-19 Weld Metal containers have orange caps.
For DUCTILE IRON, see Section 3, Cast Iron Connections
4. CADWELD F80 Alloy Weld Metal is used for all connections to load bearing rail such as Type W Bonds. F80 Weld Metal containers have yellow caps.
5. Cathodic connections require different weld metal and molds. Contact ERICO for cathodic connection applications.

CADWELD MOLDS

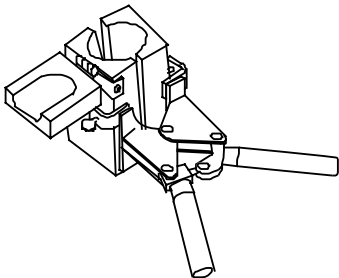

A semi-permanent graphite mold is used for making most CADWELD Connections. The mold controls the direction and speed of the molten CADWELD weld metal flow and its final shape. The graphite used in a CADWELD mold is a high temperature type that lasts for an average of 50 or more CADWELD connections under normal usage.

ADAPTING MOLDS TO FIT CONDUCTORS

Cables smaller than indicated on mold tag can be welded by using either Wrap Sleeve or Adapter Sleeves.

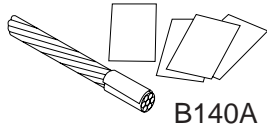

CADWELD Wrap Sleeve B140A

CADWELD Wrap Sleeve is wrapped around the cable until the diameter is about the same as the cable opening in the mold.

CADWELD Adapter Sleeves

CADWELD Adapter Sleeves are used to adapt a limited range of smaller size cables to a larger size CADWELD Mold.

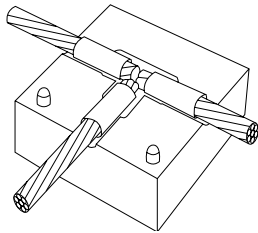

CABLE SIZE		Adapter Sleeve Part No.	Use in Mold for Stranded
Concentric Strand	Solid		
#12,14	#10,12,14	B-133-1H	#6
#7,8,10	#6,8	B-133-1L	#4
#6	#5	B-112	#2
#4,5	#3,4	B-133-1V	#2
#3,4	#2	B-133-1Y	#1
#2	#1	B-133-2C	1/0
#1	1/0	B-133-2G	2/0
1/0,1	2/0	B-133-2L	3/0
2/0,1/0	3/0	B-133-2Q	4/0

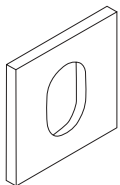

Packing

Packing consists of either preformed ceramic packing or sometimes B140A or B141A copper wrap shim. Packing is required on all rebar connections.



T403

CADWELD Mold Sealer

T403 CADWELD Mold Sealer is ideal for sealing hot or cold molds to retard leakage from large stranded conductors. It is required on certain molds such as Types HA, HB, HC, VG and VN. It prolongs useful mold life when the cable opening becomes worn.

It is available in a convenient 2 pound package.

CADWELD Sleeve Kit

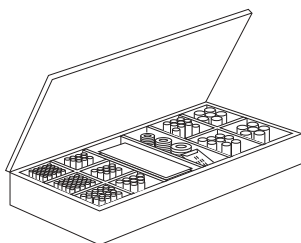

T427 Includes:			
Product #	Quantity	Product #	Quantity
B1331H	25	B1332L	8
B1331L	25	B1332Q	12
B112	18	B140A	10
B1331V	10	B117A	20
B1331Y	10	B117B	10
B1332C	9	B117C	10
B1332G	10	T320A	10

CABLE AND WORK SURFACE PREPARATION

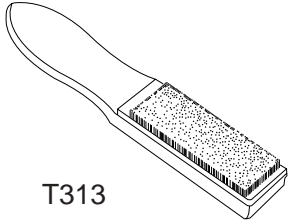

T313

Cable Cleaning Brushes

Two types of brushes are available to aid in removing oxides from copper surfaces. T313 Card Cloth Brush with short stiff bristles is generally preferred for cleaning concentric conductors and busbars, which are not heavily oxidized.

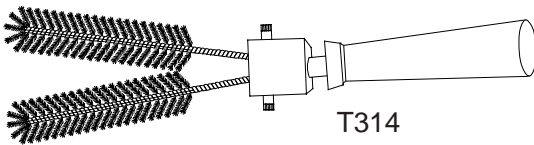

T314

T314 Cable Cleaning Brush cleans any conductor and is especially useful for coarse or very dirty conductors. The brushes can be rotated to provide new cleaning bristles and are replaceable.

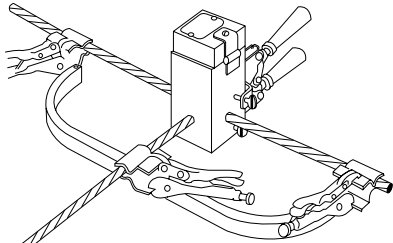

B265

Cable Clamp B265

The B265 Cable clamp should be used with hard drawn copper cable, Copperweld DSA® conductor or any cable under tension. Use of the clamp aids in preventing cable movement and prolongs mold life.

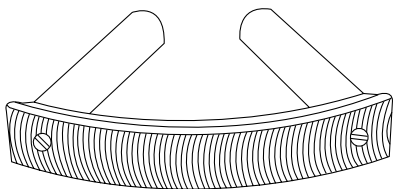

T321

Rasp

T321 rasp is used to remove rust from any steel surface or galvanizing from hot dipped galvanized steel to expose the bare steel for welding. The curved blade makes it an efficient tool for flat surfaces. T321A Replacement blades are also available.

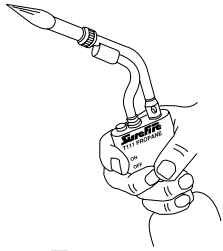

T111

Surefire™ Torch Head

T111 Self igniting propane torch head. Squeeze the control knob for an instant flame. Release and it's out. No flame adjusting. The burn tip remains cool during normal use. Operates on its side or upside down. Can withstand 60MPH winds without flare-out. Fits all standard 14 and 16 oz. propane cylinders.

SUREFIRE™ is a trademark of IPI

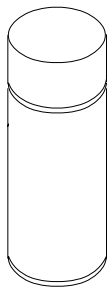

T372A

Galvanizing Touch-Up

Easy to use galvanizing paint in a spray can is used to touch up heat affected areas on galvanized steel surfaces after welding. The damage to the galvanizing is often minimal so the repair is often cosmetic. T372A galvanizing compound available in 12 ounce aerosol can.



T358

T358 Regalv is a 97% zinc rich organic coating which also can be used to repair galvanized surfaces. The brush is attached to the cap.

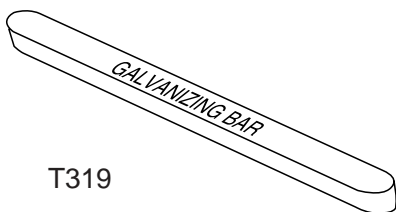

T319

T319 Galvanizing Bar is used to repair a galvanized surface that has been damaged by welding or drilling. This is a low temperature, self-fluxing material. Often there is sufficient heat after making the CAD-WELD Connection to melt the bar or a small torch may be used.

MOLD CARE AND USE

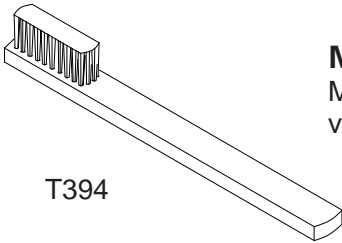

T394

Mold Cleaning Brush

Mold cleaning brush T394 is very useful for removing slag from molds – especially vertical split molds.

Slag Removal Spades

Slag Removal Spades are useful for removing the slag after making a CADWELD Connection – especially useful with horizontally split molds.

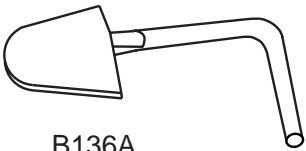

B136A
B136B

Slag Spade Part No.	Use With Mold Price	Using Weld Metal Size
B-136-A	A, C, & R	#65 & Smaller
B-136-B	C, D, F & R	#90 & Larger

Disks

Each time a weld is made, a new disk is required. The disk sits on the bottom of the crucible. Its purpose is to hold the powdered weld metal until the reaction takes place. The slag produced by the reaction rises to the surface and the molten copper settles to the bottom of the crucible where it melts the disk and flows over the conductors to produce a permanent molecular bond.

Disks are available in three sizes:

- B117A used in molds using #15 thru #32 weld metal (3/4" diameter).
 - B117B used in molds using #45 thru #115 weld metal (1" diameter).
 - B117C used in molds using #150 thru #500 weld metal (1-1/2" diameter).
- Disks are included with the Weld Metal.

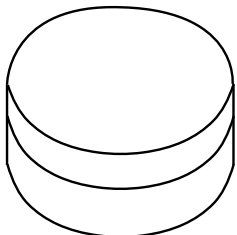
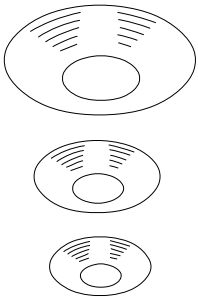

T328D

Disk Kit

A disk container (T328) which includes 20 of each of the three sizes of steel disks is available for your convenience. Kit P/N T328D.

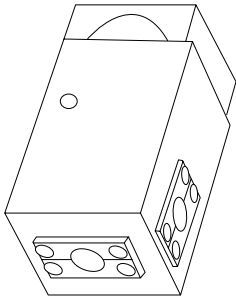

Wear Plates

Wear Plates reduce mechanical abrasion of molds at cable entry points and help prevent leakage of molten metal (particularly on larger 7 strand conductor). These features prolong mold life.

Most CADWELD Molds are available with factory mounted Wear Plates for the following sizes:

- Copper Cable: 1/0 AWG thru 500 Kcmil
- DSA Copperweld®: 7/#10 thru 19/#6
- Ground Rods: 1/2" thru 1"

To order WEAR PLATES, specify: Mold Part No. followed by the suffix "-W" i.e., TAC-2Q2Q-W.

Not available with types HA, HB, HC, LJ, certain PTs & PCs, RR, VB, VF, VG, VN, XA, XBQ or XBZ.

Following are the number of Wear Plates (W.P.) used on the various types listed in this catalog.

TYPE	W.P.	TYPE	W.P.	TYPE	W.P.
GB	1	HT	2	RC	2
GB-GR	2	LA	1	RD	2
GB-GT	3	LE	2	SS	2
GL	1	LL	1*	TA	3
GR	2	PC	3**	VS	1
GT	3	PT	4**	VT	2
GY	3	RA	1	VV	1
HS	1	RB	2	XB	4

* Available only on molds for 2" and narrower bus size.

** Available only on mold for 1/0 (or 7/#10) and larger run and tap.

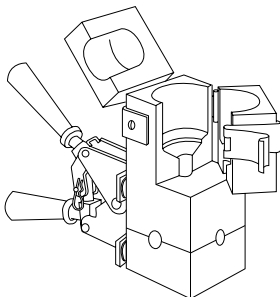

Split Crucible Molds

Molds made with a horizontal opening and solid crucible section may be specified as a SPLIT CRUCIBLE TYPE. The advantage of the SPLIT CRUCIBLE MOLD is easier cleaning, but lead times are longer.

To order a SPLIT CRUCIBLE TYPE specify: Mold Part No. followed by the suffix "-L" i.e., TAC2Q2QL.

Available in Type TA, XA, XB (C & D mold price only), LE and LJ connections.

MOLD FASTENING AND MOUNTING

CADWELD Handle Clamps

Handle Clamps such as the one shown are required for most molds. Specialized frames with handles are used on some molds. Flint ignitors are included with all Handle Clamps. The following Handle Clamps are most widely used.

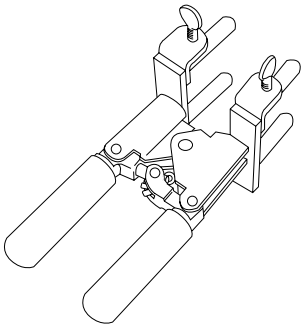

1. L160 for all molds having a "C", "E", "Q", or "R" mold price listing. (3" wide molds)
2. L159 for all molds having a "D", "F", "J" or "Z" mold price listing (4" wide molds)

Vertical Surface Mold Support

The CADWELD Mold can be securely held to a vertical "H" column or angle by using the Vertical Surface Mold Support. It is easily attached to an existing L159 or L160 Handle Clamp. For use with Types VB, VG, VN, and VS molds, fits steel up to 1" thick, for Type VF mold, 3/4" thick.

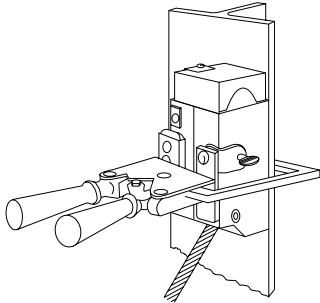

- B134: For use with L160 E-Z CHANGE Handle Clamp
 B135: For use with L159 E-Z CHANGE Handle Clamp

Chain Support Handle Clamps

The CADWELD mold can be securely held to a pipe using the clamp assembly consisting of a modified L159 or L160 Handle Clamp with built-in Pipe Attachment.

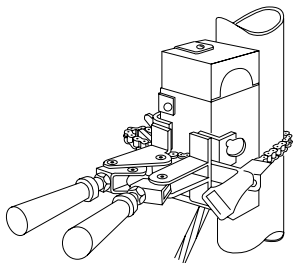

Clamp Part No.	Fits Mold Price	For Following Connection Types	Pipe
B159V	D & F	VS, VF, VB, & VV	Vertical
B160V	C & R	VS, VF, VB, & VV	Vertical
B159VT	D & F	VT	Vertical
B160VT	C & R	VT	Vertical
B159H	D & F	HA, HS, HC, & HT	Horizontal
B160H	C & R	HA, HS, HC, & HT	Horizontal

The above clamps are equipped with 20" length of chain which will fit up to 4" pipes. Extra 20" length of chain, B158, is available to fit up to 10" pipes.



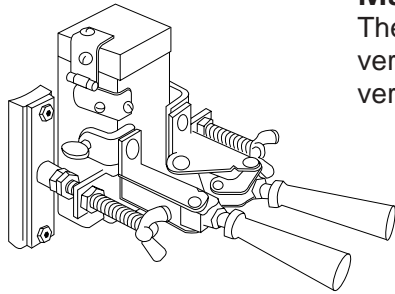

Magnetic Handle Clamps

The CADWELD mold can be securely held to a large flat or slightly curved vertical surface using the Handle Clamp with Magnetic Support. Used on vertically split molds.

Clamp Part No.	Fits Mold Price Key	Minimum Width Required*
B396	C & R Price Key	8"
B159M	D & F Price Key	10-1/2"
B399AM	T Price Key	6"
B399BM	P & N Price Key	7"

*Width will vary slightly depending upon the type of connection being made.

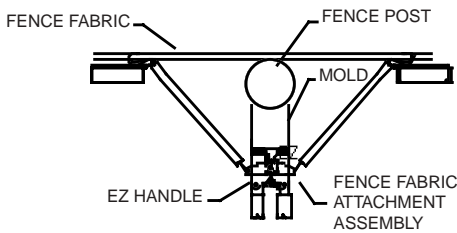

Fence Fabric Attachment Assembly

An easy to use, labor saving, Fence Fabric Attachment Assembly fastens to your existing L159 or L160 Handle Clamp to firmly hold your mold to the fence post after the fence fabric has been attached. Ideal for retrofit jobs.

Fence Fabric Attachment Part No.	Fits Handles
B827A	L160, L159

GROUND ROD SPECIALTY TOOLS



ERITECH® Ground Rod Drivers

Product #	Description
EGRD58	5' Driver body with insert for up to 5/8" ground rods
EGRD58I*	Replacement insert for 5/8" ground rods
EGRD34	5' Driver body with insert for up to 3/4" ground rods
EGRD34I*	Replacement insert for 3/4" ground rods

*Both 5/8" and 3/4" inserts fit standard body of EGRD58 or EGRD34.

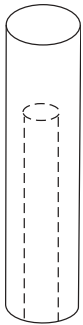

Ground Rod Driving Sleeves**

Use a CADWELD ground rod driving sleeve to prevent mushrooming top of ground rod.

Ground Rod Size	Part No.
1/2" Copper Bonded or Steel RodB137-14
5/8" Copper Bonded (.563" diameter)B137-16
5/8" Steel (.625" diameter)B137-31
3/4" Copper Bonded (.682" diameter)B137-18
3/4" Steel (.750" diameter)B137-33
1" Copper Bonded (.914" diameter)B137-22
1" Steel (1.00" diameter)B137-37

** For plain (unthreaded) ground rods only.

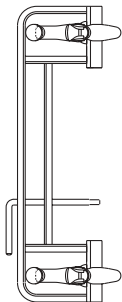

B120

Ground Rod Splice Clamp

The B120 Ground Rod Splice Clamp must be used to support the upper rod and provide a method of correctly positioning the rods and mold while splicing the rods. (Type HDGB and GB Connection).

OTHER TOOLS

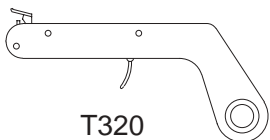

T320

Flint Ignitors

T320 CADWELD Flint Ignitors are used to ignite the starting material when making a CADWELD Connection. An ignitor is included with each Handle Clamp or frame. T320A Replacement Flints are also available.

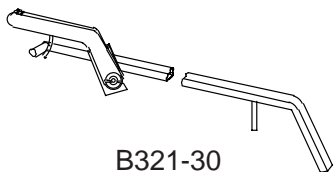

B321-30

Flint Ignitor Extension

B321-30 Flint Ignitor Extension attaches to the T320 Flint Ignitor and allows the installer to be about 30" from the mold. Ideal for such operations where the mold is in a narrow trench and the installer is at ground level.



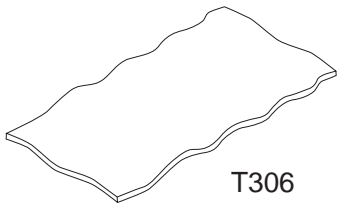

Ceramic Blanket

The woven Ceramic Blanket (Part T306) can be used to hold a hot mold or keep the work surface free of slag when cleaning the mold.

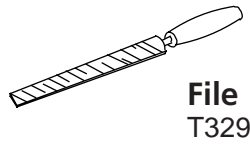

File
T329



Pliers
T304

Screwdriver
T305

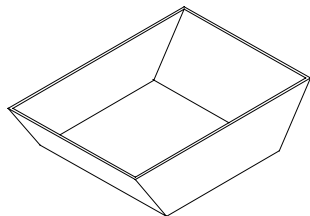
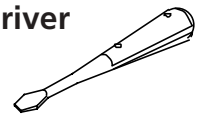

XLB974-B2

Welding Tray

The Welding Tray (Part XLB974-B2) can contain a spill of molten weld metal. It is for personnel safety. Recommended when working overhead or over expensive equipment.

TOOL KITS

Tool Box T396

A tool box is highly recommended to carry tools, molds, weld metal and a propane torch.

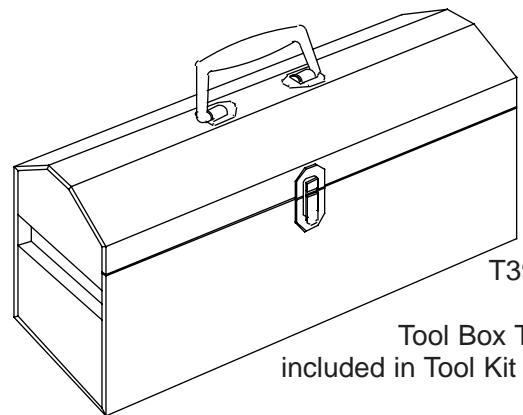

T396

Tool Box T396 is included in Tool Kit T315A

Tool Kit T315A

Other Tool Kits can be made for your particular requirements.

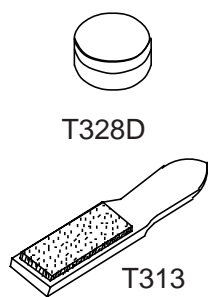

T328D

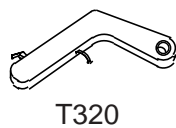

T320

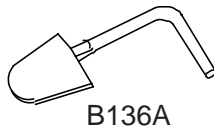

B136A

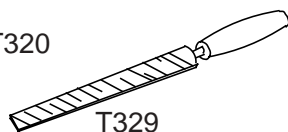

T329

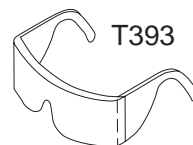

T393

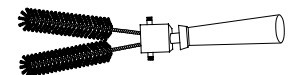

T314

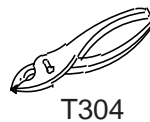

T304

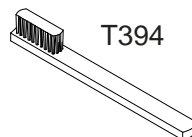

T394

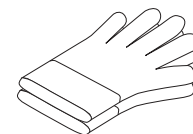

T378L

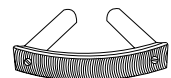

T321

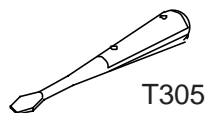

T305

TOOL TRAY

Tool Tray Only: T331

Ideal for carrying one or two molds, weld metal, propane torch and tools.

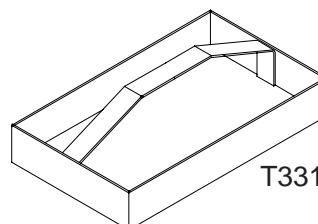

T331

Tool Tray T331 is not included in Tool Kit T315A

Ground System Testers

EST Series

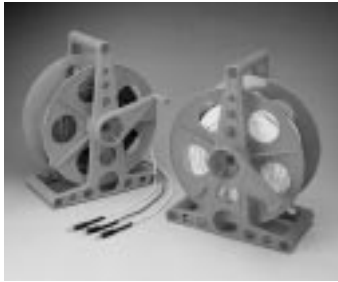

EST Reel Kit 500

Product #	Description
EST 101	2 pole resistance, 3 pole ground to earth resistance measurement @128Hz
EST 201	2 pole AC resistance, 3 pole ground to earth resistance measurement, 4 pole soil resistivity measurement
EST 301	2 pole AC resistance, 2 & 3 pole ground to earth resistance measurement, 4 pole soil resistivity, and clamp-on stakeless and selective adapters
ESTREELKIT500	EST Reel Kit 500 feet long (includes two reels)



EST101



EST201



EST301

Reference Material



Product #	Description
G157LT99	Practical Guide to Electrical Grounding

GROUNDING SYSTEM – CONDUCTORS AND CONNECTORS

The grounding conductor size is based on the maximum magnitude and duration of available fault current, and on the type of connections being used in the grounding system.

IEEE Std. 80-2000, Guide for Safety in Substation Grounding, the accepted industry standard, uses a fusing formula as the basis for selecting minimum conductor size to avoid fusing (melting) under fault conditions.

This formula can be simplified to the following:

$$A = K \cdot I \sqrt{S}$$

- Where: A = Conductor size in circular mils
 K = Constant from the following table
 I = RMS fault current in amperes
 S = Fault time in seconds

Based on the standard ambient temperature of 40°C.

MAX TEMP	CONSTANT K FOR ABOVE FORMULA		
	COPPER S.D.	COPPERWELD DSA 40%	COPPERWELD DSA 30%
1083 C	7.01	10.46	12.04
450 C	9.18	13.74	15.87
350 C	10.10	15.13	17.46
250 C	11.65	17.47	20.17

The temperatures listed above for each material are specified in IEEE Std. 80-2000 to be used for different types of connecting means;

- Pressure type connectors 250° to 350°C*
- Brazed connections 450°C
- Exothermic welded connections 1083°C

*except those which have been tested to and passed the requirements of IEEE Std. 837-1989.

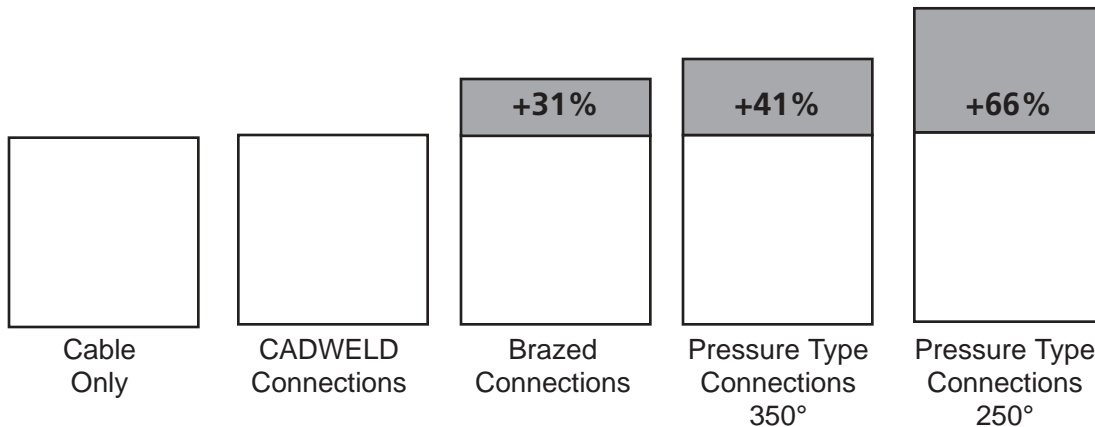

EXAMPLE – 25,000 Ampere, 2 second fault:

CONNECTION TYPE	CONDUCTOR SIZE
CADWELD246 kcmil – use 250 kcmil
Brazed322 kcmil – use 350 kcmil
Pressure Type (at 350 C)357 kcmil – use 350 kcmil
Pressure Type (at 250 C)408 kcmil – use 400 kcmil

BARE CLASS A, B, AND C CONCENTRIC STRANDED CONDUCTOR

Based on A.S.T.M. Standard Specifications.

Size in Circular mils	Size A.W.G.	Conductor Dia. In.	NUMBER OF WIRES					CADWELD Cable code
			7	19	37	61	91	
1,000,000		1.152			.1644*	.1280	.1048	4Y
800,000		1.031			.1470*	.1145	.0938	4Q
750,000		.998			.1424*	.1109	.0908	4L
700,000		.964			.1375*	.1071	.0877	4G
600,000		.893			.1273	.0992	.0812	3X
500,000		.813		.1622*	.1162	.0905		3Q
400,000		.728		.1451	.1040	.0810		3H
350,000		.681		.1357	.0973	.0757		3D
300,000		.630		.1257	.0900	.0701		3A
250,000		.575		.1147	.0822	.0640		2V
211,600	4/0	.528	.1739	.1055	.0756			2Q
167,800	3/0	.470	.1548	.0940	.0673			2L
133,100	2/0	.419	.1379	.0837	.0600			2G
105,500	1/0	.373	.1228	.0745	.0534			2C
83,690	1	.332	.1093	.0664	.0476			1Y
66,370	2	.292	.0974	.0591				1V
52,630	3	.260	.0867	.0526				1Q
41,740	4	.232	.0772	.0469				1L
26,240	6	.184	.0612	.0372				1H
16,510	8	.146	.0486	.0295				1E
10,380	10	.116	.0385	.0234				1B
6,530	12	.0915	.0305	.0185				
4,110	14	.0726	.0242	.0147				

*Class AA



BARE SOLID COPPER WIRE

DSA COPPERWELD CONDUCTOR

Based on A.S.T.M. Standard Specifications

Size A.W.G.	Cross Sectional Area Circular Mils	Wire Dia. In.	CADWELD Cable code
4/0	211,600	.4600	2P
3/0	167,800	.4096	2K
2/0	133,100	.3648	2F
1/0	105,500	.3249	2B
1	83,690	.2893	1X
2	66,370	.2576	1T
3	52,630	.2294	1P
4	41,740	.2043	1K
6	26,250	.1620	1G
8	16,510	.1285	1D
10	10,380	.1019	1A
12	6,530	.0808	
14	4,110	.0664	

Cable Stranding	Nominal Diameter	kcmil	Equivalent Copper Size*	CADWELD Cable code
7/#10	.306	72.7	3AWG	9A
7/#8	.385	115.6	1	9B
7/#7	.433	145.7	1/0	9C
7/#6	.486	183.8	2/0	9D
7/#5	.546	231.7	3/0	9E
19/#9	.572	248.8	3/0	9F
7/#4	.613	292.2	4/0	9L
19/#8	.642	313.7	4/0	9G
19/#7	.721	395.5	250 Kcmil	9H
37/#9	.801	484.4	300	7W
19/#6	.810	498.8	350	9J
37/#8	.899	610.9	400	7V
19/#5	.910	628.9	450	9K
37/#7	1.01	770.3	500	9M

*Approximate based on Fusing Current calculations and tests by Copperweld Co.

GROUND RODS

Nominal Size	Material	Type	Thread Size	Body Dia.	CADWELD Ground Rod Code
1/2"	Copperclad Steel*	Sectional	9/16"	.505	14
		Plain		.500	14
	Copperclad	Plain	1/2"	.475	15
	Copperclad	Sectional		.447	13
5/8"	Copperclad Steel*	Sectional	5/8"	.563	16
		Plain		.625	31
	Copperclad	Plain		.563	16
3/4"	Copperclad Steel*	Sectional	3/4"	.682	18
		Plain		.750	33
	Copperclad	Plain		.682	18
1"	Copperclad Steel*	Sectional	1"	.914	22
		Plain		1.00	37
	Copperclad	Plain		.914	22

* Plain steel, stainless steel, stainless clad rods or galvanized steel.

RECTANGULAR COPPER BUSBAR

Thickness Inches	Width Inches	Circular Mil Size	Weight Lbs. per Foot	CADWELD Bus Bar Code
1/8	1	159,200	.484	CE
	1-1/2	238,700	.726	CG
	2	318,300	.969	CH
3/16	1	238,700	.727	DE
	2	477,500	1.45	DH
1/4	1	318,300	.969	EE
	1-1/2	477,500	1.45	EG
	2	636,600	1.94	EH
	3	954,900	2.91	EK
	4	1,273,000	3.88	EM
3/8	1	477,500	1.45	GE
	1-1/2	716,200	2.18	GG
	2	954,900	2.91	GH
	3	1,432,000	4.36	GK
	4	1,910,000	5.81	GM
1/2	2	1,273,000	3.88	JH
	3	1,910,000	5.81	JK
	4	2,546,000	7.75	JM

REINFORCING BARS

USEFUL CONVERSIONS	
Area	
Square Inches x 1273 = kcmil	
Square Millimeters x 1.974 = kcmil	
kcmil x 0.5067 = Square Millimeters	
Density	
Copper:	0.323lb/in ³
Steel:	0.283lb/in ³

Rebar Sizes	NOMINAL DIMENSIONS Dia. Inches	Cross-Sectional Area - Sq. Inches	Equivalent Copper Sizes*	CADWELD Rebar Code
3	.375	.11	9AWG	51
4	.500	.20	7	52
5	.625	.31	5	53
6	.750	.44	3	54
7	.875	.60	2	55
8	1.000	.79	1	56
9	1.128	1.00	1/0	57
10	1.270	1.27	2/0	58
11	1.410	1.56	3/0	59
14	1.693	2.25	250 kcmil	60
18	2.257	4.00	450	61

* Based on 8% IACS, rounded to the next higher commercial copper size.



STANDARD STEEL WIRE GAGE

(WASHBURN MOEN GAGE) SOLID

Gage No.	Dia. Inches	Gage No.	Dia. Inches
7/0	.490	6	.1920
6/0	.4615	7	.1770
5/0	.4305	8	.1620
4/0	.3938	9	.1483
3/0	.3625	10	.1350
2/0	.3310	11	.1205
1/0	.3065	12	.1055
1	.2830	13	.0915
2	.2625	14	.0800
3	.2437	15	.0720
4	.2253	16	.0625
5	.2070	17	.0540

STEEL PIPE SIZES

STANDARD WEIGHT ASTM A53-90-B
(SCHEDULE 40) ANSI/ASME B36.10M-1985

Nominal Size In	O.D. Inches	Wall Thickness Inches	CADWELD Mold Code
1	1.315	.133	1
1-1/4	1.660	.140	1.25
1-1/2	1.900	.145	1.50
2	2.375	.154	2
2-1/2	2.875	.203	2.50
3	3.500	.216	3
3-1/2	4.000	.226	3.50
4	4.500	.237	4
5	5.563	.258	5
6	6.625	.280	6
8	8.625	.322	8
10	10.750	.365	10

CAST IRON PIPE – CLASS A THRU D

AWWA Specification 1908,
ASA A21.2 Class 100-250.

Nominal Size (Inches)	Actual O.D. (Inches)
4	4.80 to 5.00
6	6.90 to 7.10
8	9.05 to 9.30
10	11.10 to 11.40
12	13.20 to 13.50
14	15.30 to 15.70
16	17.40 to 17.80
18	19.50 to 19.90
20	21.60 to 22.1
24	25.80 to 26.30
30	31.70 to 32.70
36	38.00 to 39.20
42	44.20 to 45.60
48	50.50 to 52.00
54	56.70 to 58.40
60	62.80 to 64.80
72	75.30 to 76.90
84	87.50 to 88.50

Other standard sections used for fence posts

Section	CADWELD Mold Code
1-1/2" square	PS15
2" square	PS20
2-1/2" square	PS25
3" square	PS30*
1.875 x 1.625 x .133 "H"	PH1
2.25 x 1.95 x .143 "H"	PH2

* For D or F mold price only

OTHER SPECIALIZED APPLICATION CATALOGS, APPLICATIONS, BULLETINS AND TECHNICAL INFORMATION**A1L STATIC GROUNDING CONNECTIONS****A4G SUBSTATION GROUNDING**

Numerous applications and guidelines for grounding electrical supply station (substations).

A4P COMPUTER ROOM GROUNDING

Widely accepted system of grounding and signal reference grids to protect vital computer data and reduce downtime.

A7D INSTALLERS AND INSPECTORS GUIDE

A guide for installation and inspection of CADWELD exothermically welded connections.

A7J GEM BROCHURE

Brochure describing GEM Ground Enhancement Material used to lower resistance to earth.

A9E CONTRACTOR TIPS

Ideal for contractors – How to save time and make the installation easy.



TRAINING VIDEOS

CWTAPEA	How To Make a CADWELD Connection
CWTAPEB	Basic Grounding, Includes Testing
CWTAPEC	Basic Grounding
CWTAPED	CADWELD ONE-SHOT
CWTAPEE	EXOLON
CWTAPEF	How to Make a Heavy Duty Ground Rod Splice
CWTAPEG	Reducing Transient Threats with SRGs
CWTAPEH	Signal Reference Grid Installation
CWTAPEJ	CADWELD in the Rain
CWTAPEK	GRIDMAKER vs. BURNDY®

SOFTWARE

	CADWELD has specialized design software packages:
SRG Disk (Demonstration)	Computer room design – in AutoCAD® drawings or DXF style
CAD CLUB CD	Various connections and applications – AutoCAD drawings.
A5U (ASCII) Disk	Grounding specifications – ASCII format so it can be read by any word processing software. (ref. publication A5U)
S219D	Facility Electrical Protection Six Point Plan CD.

For copies of any of the above catalogs, application bulletins, software or to schedule training, contact your local CADWELD representative or ERICO at:

800-677-9089 • Fax: 800-677-8131

ELECTRICAL GROUNDING and BONDING

CADWELD®

Molds & Weld Metal

EXOLON – Low Emission

ONE-SHOT – Disposable Molds Lugs, Tools
& Accessories

ERITECH®

Ground Rods & Accessories

Chemical Ground Rods

Ground Clamps

Ground Plate Electrodes

Ground Rod Couplings

Ground Rod Drivers

Ground Rods – Copperbonded,
Galvanized, Stainless Steel

Bonding Products

Aircraft Ground Receptacles

Bonding Jumpers

Equipment Ground Plates

Equipotential Mesh

Fence & Gate Bonds

Grounding & Bonding Bars

Perimeter Busbars

Personnel Safety Mats

Split Bolts

SRG – Signal Reference Grids

Static Bonding Products

Switch Handle Bonds

TIA/EIA Ground Bars

Water-Pipe Clamps

Miscellaneous Grounding Products

GEM Ground Enhancement Material

Ground Inspection Wells

Ground Test Instruments

Grounding Conductor

LIGHTNING PROTECTION

ERITECH®

Lightning Protection Products

SYSTEM 2000

– Conventional Lightning Protection

SYSTEM 3000

– Active Lightning Protection

Lightning Warning System

Industrial Stack Protection

Support Equipment

Air Terminals, Bases, Conductors, Masts

Fasteners & Fittings

SURGE PROTECTION

CRITEC®

Surge Protection Products

Service Entrance

OEM Protection Components

Data & Signal Line Protection

Load Cell Protection

Branch Panel

Complete Home Protectors

Telecommunication Shelter Protection

Automation & Control Protection

ERICO®



www.erico.com



AUSTRALIA
Phone 61-2-9751-8500
Fax 61-2-9475-5334

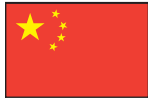

CHINA
Phone 86-21-3430-4878
Fax 86-21-5831-8177



HUNGARY
Phone 31-13-58-35-415
Fax 31-13-58-35-499



NORWAY
Phone 47-67-53-12-00
Fax 47-67-12-42-68



SWITZERLAND
Phone 00-800-5000-1090
Fax 00-800-6000-1090



BELGIUM
Phone 32-14-69-96-88
Fax 32-14-69-96-90



DENMARK
Phone 46-40-611-13-60
Fax 46-40-611-9415



INDONESIA
Phone 62-21-575-0941
Fax 62-21-575-0942



POLAND
Phone 48-71-374-40-22
Fax 48-71-374-40-43



THAILAND
Phone 66-2-267-5776
Fax 66-2-636-6988



BRAZIL
Phone 55-11-3623-4333
Fax 55-11-3621-4066



FRANCE
Phone 33-4-77-36-54-32
Fax 33-4-77-55-20-10



ITALY
Phone 39-02-8474-2250
Fax 39-02-8474-2251



SINGAPORE
Phone 65-6-268-3433
Fax 65-6-268-1389



UNITED ARAB EMIRATES
Phone 971-4-881-7250
Fax 971-4-881-7270



CANADA
Phone 1-800-677-9089
Fax 1-800-677-8131



GERMANY
Phone 0-800-189-0272
Fax 0-800-189-0274



MEXICO
Phone 52-55-5260-5991
Fax 52-55-5260-3310



SPAIN
Phone 34-93-467-7726
Fax 34-93-467-7725



UNITED KINGDOM
Phone 44-118-958-8386
Fax 44-118-955-0925



CHILE
Phone 56-2-370-2908
Fax 56-2-370-2914



HONG KONG
Phone 852-2764-8808
Fax 852-2764-4486



NETHERLANDS
Phone 31-13-58-35-400
Fax 31-13-58-35-499



SWEDEN
Phone 46-40-611-13-60
Fax 46-40-611-94-15



UNITED STATES
Phone 1-440-248-0100
Fax 1-440-248-0723