

Trunk Cables



Specifications

| | |
|------------------------------|---|
| Certifications | UL |
| Standards Compliance | UL 2237 |
| Mechanical | |
| Coupling Nut | Black Anodized Aluminum |
| Housing | Black PVC |
| Insert | Black PVC |
| Cable Diameter | 0.775 in. +/- 0.12 in. (19.68 mm +/- 0.5 mm) |
| Electrical | |
| Contacts | Copper Alloy with Gold over Nickel Plating |
| Cable | Black PVC, dual rated UL TC/Open Wiring and STOOW |
| Cable Rating | 600V AC/DC |
| Assembly Rating | 600V @ 25 A, Symmetrical Amps RMS Fault: 65 kA when used with Class CC, T, or J type fuses |
| Environmental | |
| Enclosure Type Rating | IP67, NEMA 4 & 6P; 1200 psi washdown |
| Operating Temperature | UL Type TC 600V 90 °C Dry 75 °C Wet, Exposed Run (ER) or MTW 600V 90 °C or STOOW 105 °C 600V - CSA STOOW 600V FT2 |

Features

- Rated for motor branch circuits per UL 2237
- One piece molded design
- Can be used as a drop cable for 25 A rated ArmorStart Distributed Motor Controller or when desired to minimize voltage drops on extended cable runs

Dimensions—mm (inches)

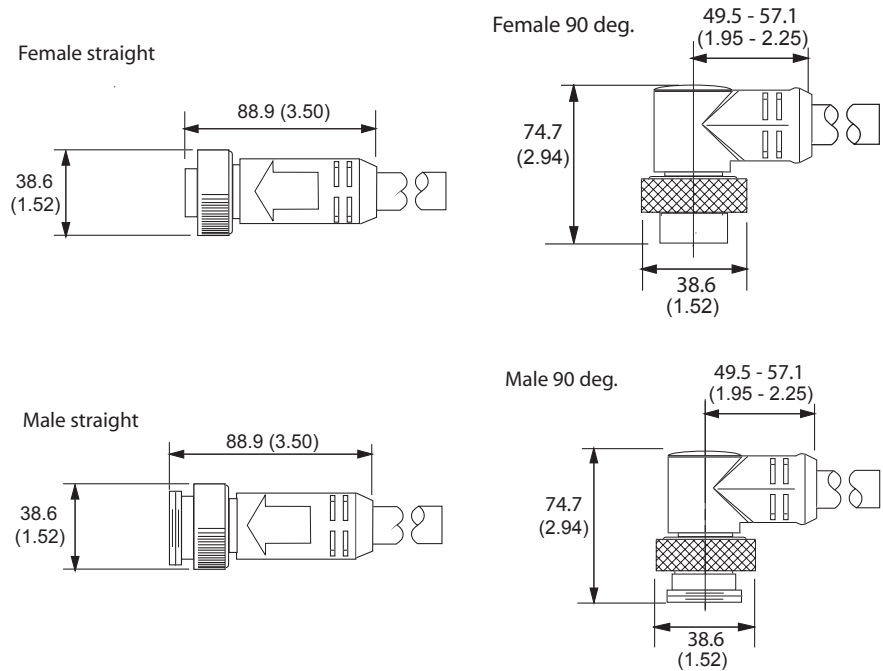

Dimensions are approximate. Illustrations are not drawn to scale.

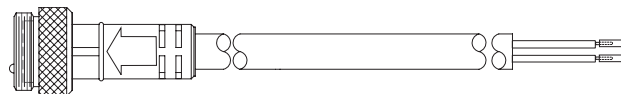

Example of Cordset

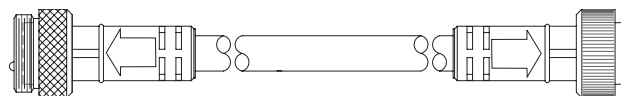

Example of Patchcord

ArmorStart Power Media

Three Phase Power Cordsets and Patchcords - Trunk Cables

25 A, TC-ER/STOOW PVC

Pinout and Color Code

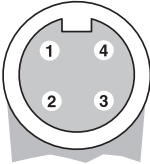
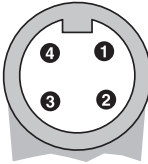
| | Face View Pinout | |
|------------|---|---|
| | 4-Pin | |
| |  <p style="text-align: center;">Female</p> |  <p style="text-align: center;">Male</p> |
| Color Code | 1 Black 2 Green/Yellow Extended PIN | 3 Red 4 White |

Product Selection

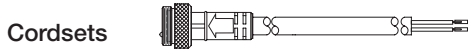

| Pin Count | Assembly Rating | Cat. No. | | | |
|-----------|-----------------|-----------------|--------------------|----------------|------------------|
| | | Straight Female | Right-Angle Female | Straight Male | Right-Angle Male |
| 4-Pin | 600V, 25 A | 280-PWRM35E-M* | 280-PWRM35F-M* | 280-PWRM35G-M* | 280-PWRM35H-M* |

* Replace symbol with 05 (0.5 m (1.62 ft)), 1(1 m (3.3 ft)), 015(1.5 m (4.9 ft)),2(2 m (6.5 ft)),025 (2.5 m (8.1 ft)), 3 (3 m (9.8 ft)), 4 (4 m (13.1 ft)), 6 (6 m (19.7 ft)),8(8 m (26.2 ft)),10 (10 m (32.8 ft)), 12 (12 m (39.4 ft)), or 14 (14 m (45.9 ft)).

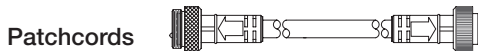

| Pin Count | Assembly Rating | Cat. No. | | | |
|-----------|-----------------|----------------------------------|-------------------------------------|-------------------------------------|--|
| | | Straight Female Straight Male | Right-Angle Female Straight Male | Straight Female Right-Angle Male | Right-Angle Female Right-Angle Male |
| 4-Pin | 600V, 25 A | 280-PWRM35A-M* | 280-PWRM35B-M* | 280-PWRM35C-M* | 280-PWRM35D-M* |

* Replace symbol with 05 (0.5 m (1.62 ft)), 1(1 m (3.3 ft)), 015(1.5 m (4.9 ft)),2(2 m (6.5 ft)),025 (2.5 m (8.1 ft)), 3 (3 m (9.8 ft)), 4 (4 m (13.1 ft)), 6 (6 m (19.7 ft)),8(8 m (26.2 ft)),10 (10 m (32.8 ft)), 12 (12 m (39.4 ft)), or 14 (14 m (45.9 ft)).