

Installation Instructions

ArmorPoint I/O 2-Port EtherNet/IP Adapter, Series A

Catalog Number 1738-AENTR

Topic	Page
Important User Information	2
Environment and Enclosure	3
Prevent Electrostatic Discharge	3
About the Module	4
Mount the Adapter and I/O Base	7
Set the Network Address	9
Wire the EtherNet/IP Adapter	10
Interpret the Status Indicators	11
Specifications	16

Important User Information

Solid state equipment has operational characteristics differing from those of electromechanical equipment. Safety Guidelines for the Application, Installation and Maintenance of Solid State Controls (Publication SGI-1.1 available from your local Rockwell Automation sales office or online at <http://literature.rockwellautomation.com>) describes some important differences between solid state equipment and hard-wired electromechanical devices. Because of this difference, and also because of the wide variety of uses for solid state equipment, all persons responsible for applying this equipment must satisfy themselves that each intended application of this equipment is acceptable.





In no event will Rockwell Automation, Inc. be responsible or liable for indirect or consequential damages resulting from the use or application of this equipment.

The examples and diagrams in this manual are included solely for illustrative purposes. Because of the many variables and requirements associated with any particular installation, Rockwell Automation, Inc. cannot assume responsibility or liability for actual use based on the examples and diagrams.

No patent liability is assumed by Rockwell Automation, Inc. with respect to use of information, circuits, equipment, or software described in this manual.

Reproduction of the contents of this manual, in whole or in part, without written permission of Rockwell Automation, Inc., is prohibited.

Throughout this manual, when necessary, we use notes to make you aware of safety considerations.

WARNING 	Identifies information about practices or circumstances that can cause an explosion in a hazardous environment, which may lead to personal injury or death, property damage, or economic loss.
IMPORTANT	Identifies information that is critical for successful application and understanding of the product.
ATTENTION 	Identifies information about practices or circumstances that can lead to personal injury or death, property damage, or economic loss. Attentions help you identify a hazard, avoid a hazard and recognize the consequences.
SHOCK HAZARD 	Labels may be on or inside the equipment (for example, drive or motor) to alert people that dangerous voltage may be present.
BURN HAZARD 	Labels may be on or inside the equipment (for example, drive or motor) to alert people that surfaces may reach dangerous temperatures.

Environment and Enclosure

ATTENTION

This equipment is intended for use in overvoltage Category II applications (as defined in IEC 60664-1), at altitudes up to 2000 m (6562 ft) without derating.

This equipment is considered Group 1, Class A industrial equipment according to IEC/CISPR 11. Without appropriate precautions, there may be difficulties with electromagnetic compatibility in residential and other environments due to conducted and radiated disturbances.

This equipment is supplied as enclosed equipment. It should not require additional system enclosure when used in locations consistent with the enclosure type ratings stated in the Specifications section of this publication. Subsequent sections of this publication may contain additional information regarding specific enclosure type ratings, beyond what this product provides, that are required to comply with certain product safety certifications.

In addition to this publication, see:

- Industrial Automation Wiring and Grounding Guidelines, Allen-Bradley publication [1770-4.1](#), for additional installation requirements.
- NEMA Standards 250 and IEC 60529, as applicable, for explanations of the degrees of protection provided by different types of enclosure.

Prevent Electrostatic Discharge

ATTENTION

This equipment is sensitive to electrostatic discharge, which can cause internal damage and affect normal operation. Follow these guidelines when you handle this equipment.

- Touch a grounded object to discharge potential static.
 - Wear an approved grounding wriststrap.
 - Do not touch connectors or pins on component boards.
 - Do not touch circuit components inside the equipment.
 - Use a static-safe workstation, if available.
 - Store the equipment in appropriate static-safe packaging when not in use.
-

4 ArmorPoint I/O 2-Port EtherNet/IP Adapter, Series A

ATTENTION

Make sure all connectors and caps are securely tightened to properly seal the connections against leaks and maintain IP enclosure type requirements.

ATTENTION

To comply with the CE Low Voltage Directive (LVD), all connected I/O must be powered from a source compliant with the following:
Safety Extra Low Voltage (SELV) or Protected Extra Low Voltage (PELV).

About the Module

The ArmorPoint I/O 2-Port EtherNet/IP adapter provides connectivity to an EtherNet/IP network via two M12 Ethernet-keyed connectors for 2-port pass-through to support daisy chains or rings, and the existing star and tree network topologies.

The adapter ships with a terminating base to be used with the last I/O module on the backplane. The sealed IP67 housing of the adapter requires no enclosure. (Note that environmental requirements other than IP67 may require an additional appropriate housing.) The EtherNet/IP connector is a sealed D-coded M12 (micro) style.

1738-AENTR Adapter, Series A

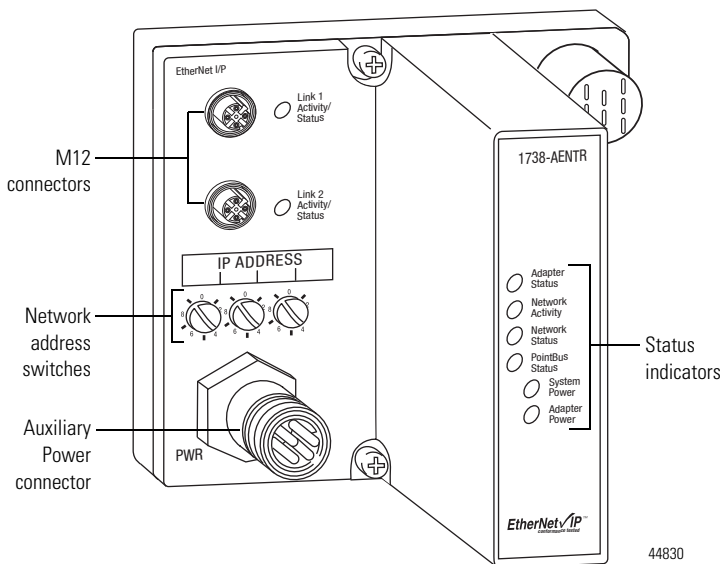

Before You Begin

To effectively use your adapter, note the following considerations.

Determine Compatibility

RSLogix 5000 version 17 or greater must be used for the 1738-AENTR's Add-on Profile. The 1738-AENTR adapters will accept I/O connections with the electronic keying for the 1738-AENT. This allows the 1738-AENTR adapter to be used in a daisy-chain topology with the 1738-AENT's profile used for the 1738-AENTR.

If using the adapter with a 1756-ENBT module, 1768-ENBT module or an L3xE processor, use the following required firmware versions for these bridge modules:

- 1756-ENBT firmware version 4.5 or greater
- 1768-ENBT firmware version 2.1 or greater
- L3xE processor firmware version 17 or greater

If you use the BootP utility to assign IP addresses to the adapter, use version 2.3.2 or greater.

Understand Messaging

Class 3 (Explicit Message) requests through the adapter to a specific I/O module may not always receive a response from the I/O module. In the case where the I/O module does not reply to the request, the adapter responds with an error code indicating a time-out.

Establish I/O Connections

When you power up an ArmorPoint I/O system and establish I/O connections, the outputs transition to the Idle state, applying Idle state data before going to RUN mode. This occurs even when the controller making the connection is already in RUN mode.

Configure Autobaud

The adapter cannot reconfigure an I/O module that you previously configured to operate at a fixed baud rate. When you reuse an ArmorPoint I/O module from another ArmorPoint I/O system, configure the module to autobaud before using it with the adapter.

Mount the Adapter and I/O Base

To mount the ArmorPoint I/O adapter on a wall or panel, use the screw holes provided with the ArmorPoint I/O adapter.

IMPORTANT

The ArmorPoint I/O adapter must be mounted on a grounded metal mounting plate or other conductive surface.

Mounting illustration for the ArmorPoint I/O adapter with I/O bases

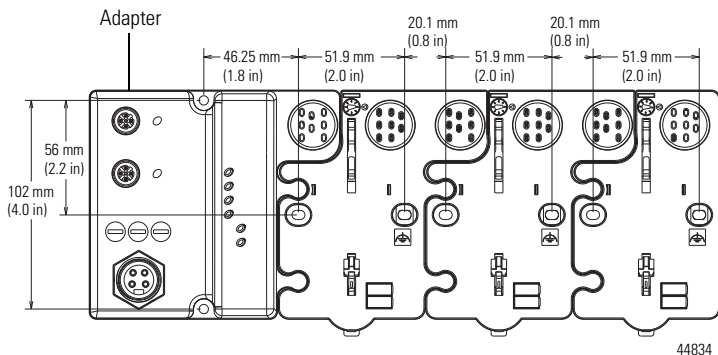

Follow the instructions to install the mounting base.

1. Lay out the required points as shown above in the drilling dimension drawing.
2. Drill the necessary holes for M4 (#8) machine or self-tapping screws.
3. Mount the adapter using M4 (#8) screws.

4. Ground the system using the ground lug connection in the I/O base. (The ground lug connection is also a mounting hole.)

Mounting base

Set to keyswitch position to 4 for the 1738 analog output modules

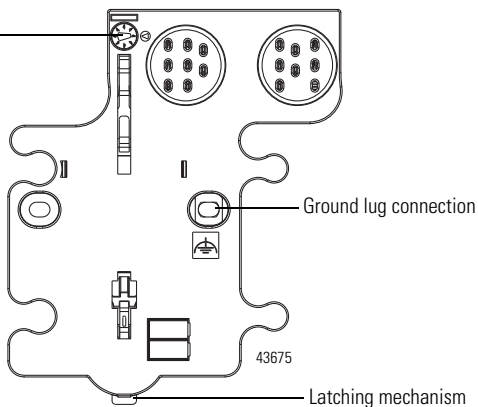

5. Mount the terminating base that was shipped with the adapter as the last base in the backplane instead of the base that was shipped with the I/O module.

Set the Network Address

The adapter ships with the rotary network address switches set to 999 and DHCP enabled. To change the network address, you can:

- adjust the switches on the front of the module
- use a Dynamic Host Configuration Protocol (DHCP) server, such as Rockwell Automation BootP/DHCP
- retrieve the IP address from nonvolatile memory

The adapter reads the switches first to determine if the switches are set to a valid number. Set the network address by adjusting the three switches on the front of the module.

Network Address Example

This example shows the network address set at 163.

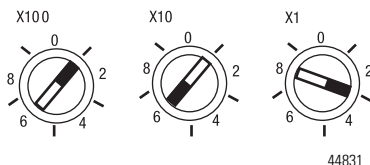

Use a small blade screwdriver to rotate the switches. Line up the small notch on the switch with the number setting you wish to use. Valid settings range from 001...254.

When the switches are set to a valid number, the adapter's IP address is 192.168.1.xxx (where xxx represents the number set on the switches). The adapter's subnet mask is 255.255.255.0 and the gateway address is set to 0.0.0.0. When the adapter uses the network address set on the switches, the adapter does not have a host name assigned to it or use any Domain Name System.

If the switches are set to an invalid number (for example, 000 or a value greater than 254 excluding 888), the adapter checks to see if DHCP is enabled. If DHCP is enabled, the adapter asks for an address from a DHCP server. The DHCP server also assigns other Transport Control Protocol (TCP) parameters.

If DHCP is not enabled, the adapter uses the IP address (along with other TCP configurable parameters) stored in nonvolatile memory.

10 ArmorPoint I/O 2-Port EtherNet/IP Adapter, Series A

Refer to publication 1738-UM014, ArmorPoint I/O EtherNet/IP Adapter User Manual, for more information.

Wire the EtherNet/IP Adapter

Following are wiring instructions for the ArmorPoint EtherNet/IP adapter.

1738-AENTR EtherNet/IP Connectors

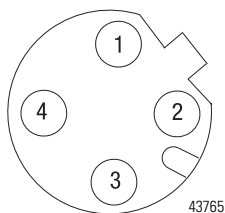

M12 Female In Connector

(view into connector)

Pin 1 - Tx +

Pin 2 - Rx +

Pin 3 - Tx -

Pin 4 - Rx -

1738-AENTR Auxiliary Power Connector

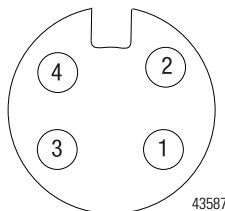

M18 Male In Connector

(view into connector)

Pin 1 - User Power +

Pin 2 - Adapter Power +

Pin 3 - Adapter Power -

Pin 4 - User Power -

IMPORTANT

Analog modules have earth grounded metal rings. This should be considered when choosing shielded cables and grounding techniques.

ATTENTION



Make sure all connectors and caps are securely tightened to properly seal the connections against leaks and maintain IP enclosure type requirements.

Interpret the Status Indicators

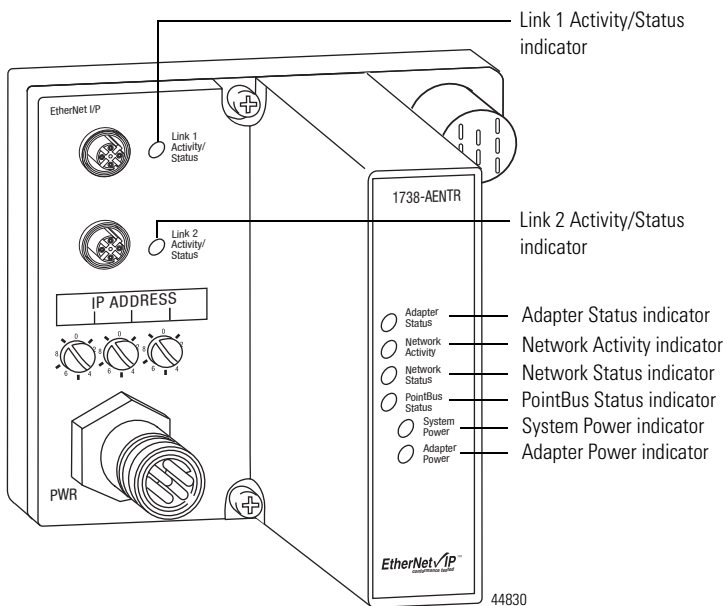

Adapter Status

Status	Description	Recommended action
Off	No power applied to device.	Apply power to device.
Green	Device operating normally.	None.
Flashing red/green	Device is in self-test.	None.
Flashing red	Recoverable fault has occurred: <ul style="list-style-type: none"> - Firmware (NVS) update. - Address switches changed. 	<ul style="list-style-type: none"> - Complete firmware update. - Verify address switches.

Adapter Status (Continued)

Status	Description	Recommended action
Red	Unrecoverable fault has occurred: - self-test failure (Flash checksum failure at power up, ramtest failure or EEPROM checksum failure at cycle power). - firmware fatal error.	Replace device.

Network Activity

Status	Description	Recommended action
Off	No link established with Port 1 or Port 2.	Verify network cabling, and correct, as needed.
Green	- Link established with Port 1 and/or Port 2 at 100 Mbps. - Link established with Port 1 and Port 2. One port at 100 Mbps and one port at 10 Mbps.	None.
Flashing green	- Transmit or receive activity present on Port 1 and/or Port 2 at 100 Mbps. - Transmit or receive activity present on Port 1 and/or Port 2. One port at 100 Mbps and one port at 10 Mbps.	None.
Yellow	Link established with Port 1 and/or Port 2 at 10 Mbps.	None.
Flashing yellow	Transmit or receive activity present Port 1 and/or Port 2 at 10 Mbps.	None.

Network Status

Status	Description	Recommended action
Off	Device not initialized. Device does not have an IP address.	Apply power to device, verify IP address, and correct, as needed.
Green	CIP connections present. Device online and has an IP address, and CIP connections are established.	None.
Flashing green	No CIP connections present. Device has an IP address, but no CIP connections are established.	None.
Flashing red/green	Device is in self-test.	None.
Flashing red	One or more CIP connections have timed out.	Check for I/O module failure and controller operation, and correct, as needed.
Red	Duplicate IP address detected.	Verify IP address setting and correct, as needed.

System Power

Status	Description	Recommended action
Off	Not active; adapter power is off or DC-DC converter problem is present.	<ol style="list-style-type: none"> 1. Verify power is on, and apply power if needed. 2. Verify backplane power not exceeded, and correct as needed. 3. Replace device.
Green	System power is on; DC-DC converter output is active (5V).	None.

Adapter Power

Status	Description	Recommended action
Off	Not active; adapter power is off.	Apply adapter power.
Green	Power is on; 24V input is present.	None.

PointBus Status

Status	Description	Recommended action
Off	Device is not online. - Device has not completed dup_MAC_id test. - Device not powered - check Adapter Status indicator.	Apply power to device, wait for dup_MAC_id to complete, and correct, as needed.
Green	Device is online and has connections in the established state.	None.
Flashing green	Device is online but has no connections in the established state. Firmware (NVS) update in progress.	None. Wait for the firmware update to complete.
Flashing red/green	LED cycle power test present.	None.
Flashing red	Communication faulted device - the device has detected a network access error and is in communication faulted state. Device has received and accepted an Identify Communication Faulted Request - long protocol message.	Verify that adapter is properly installed, and reinstall, as needed.

PointBus Status (Continued)

Status	Description	Recommended action
Red	Unrecoverable fault has occurred: - device is bus off.	<ol style="list-style-type: none"> 1. Make sure an I/O module is not using a MAC ID = 0. 2. Make sure all backplane modules are communicating at the proper baud rate. 3. Cycle power to device. 4. If condition persists, replace device.

Link 1 or Link 2 Activity/Status

Status	Description	Recommended action
Off	No link established.	Verify network cabling, and correct, as needed.
Green	Link established at 100 Mbps.	None.
Flashing green	Transmit or receive activity present at 100 Mbps.	None.
Yellow	Link established at 10 Mbps.	None.
Flashing yellow	Transmit or receive activity present at 10 Mbps.	None.

Specifications

General

Attribute	Value
Number of modules supported, maximum	63
Number of rack optimized connections	5 (for digital modules only)
Number of direct connections, maximum	20
Backplane output current, maximum	0.8 A The actual number of modules can vary. Add up the requirements of the modules you want to use, for current, to make sure they do not exceed the amperage limit of 0.8 A for the 1738-AENTR. Backplane current can be extended beyond 0.8 A by using a 1738-EP24DC Backplane Extension Power Supply. Add multiple 1738-EP24DC modules to achieve the maximum limit of 63 modules.
Input voltage rating	24V DC nominal 10...28.8V DC range
Field side power requirements	24V DC (+20% = 28.8 V DC maximum) @ 400 mA maximum
Inrush current, maximum	6 A for 10 ms
Interruption	Output voltage will stay within specifications when input drops out for 10 ms at 10V with maximum load.
Input overvoltage protection	Reverse polarity protected
PointBus output current, maximum	0.8 A @ 5V DC \pm 5% (4.75...5.25V DC)
Auxiliary power cable ⁽¹⁾	Standard cordset (single-ended): Allen-Bradley part number 889N-F4AFC-yF Standard patchcord (double-ended): Allen-Bradley part number 889N-F4AFNM-x

General (Continued)

Attribute	Value
Indicators	3 red/green status indicators on CPU: <ul style="list-style-type: none"> - Adapter Status - Network Status (Ports 1 and 2 combined) - PointBus Status 1 green/yellow status indicator on CPU: <ul style="list-style-type: none"> - Network Activity (Ports 1 and 2 combined) 2 green/yellow status indicators on base: <ul style="list-style-type: none"> - Link 1 Activity/Status - Link 2 Activity/Status 2 green power supply status indicators on DC-DC converter: <ul style="list-style-type: none"> - System Power (5V DC to PointBus Out) - Adapter Power (24V DC from Field In)
Power consumption, maximum	10.4W @ 28.8V DC
Power dissipation, maximum	6.3W @ 28.8V DC
Thermal dissipation, maximum	21.5 BTU/hr @ 28.8V DC
Isolation voltage	50V (continuous), Basic Insulation Type
Field power bus voltage, nominal	24V DC
Field power bus supply voltage range	10...28.8V DC range
Field power bus supply current, maximum	10 A
Dimensions (H x W x D), approx.	112 x 123 x 67 mm (4.41 x 4.84 x 2.64 in.)
Wiring category ⁽²⁾	1 - on power ports 1 - on communications ports

General (Continued)

Attribute	Value
Weight, approx.	0.33 kg (0.72 lb)
Mounting type	Metal panel
Enclosure type rating	Meets IP65/66/67/69K (when marked)

- ⁽¹⁾ Refer to publication [M116-CA001A-EN-P](#) for more information.
- ⁽²⁾ Use this Conductor Category information for planning conductor routing. Refer to Industrial Automation Wiring and Grounding Guidelines, publication [1770-4.1](#).

Specifications for Ethernet Communication

Attribute	Value
Ethernet communication rate	10/100 Mbps, half or full-duplex
Ethernet ports	2, configured as Embedded Switch
Ethernet network topologies supported	Star, Tree, Daisy chain/Linear, and Ring
Ethernet connector	M12, D code, female, with Ethernet keying
Ethernet cable	Category 5: Shielded or unshielded

Environmental

Attribute	Value
Temperature, operating	IEC 60068-2-1 (Test Ad, Operating Cold), IEC 60068-2-2 (Test Bd, Operating Dry Heat), IEC 60068-2-14 (Test Nb, Operating Thermal Shock): -20...60 °C (-4...140 °F)
Temperature, nonoperating	IEC 60068-2-1 (Test Ab, Unpackaged Non-operating Cold), IEC 60068-2-2 (Test Bb, Unpackaged Non-operating Dry Heat): -40...85 °C (-40...185 °F)
Relative humidity	IEC 60068-2-30 (Test Db, Unpackaged Damp Heat): 5...95% non-condensing
Vibration	IEC 60068-2-6 (Test Fc, Operating): 5 g @ 10...500 Hz
Shock, operating	IEC 60068-2-27 (Test Ea, Unpackaged Shock): 30 g
Shock, nonoperating	IEC 60068-2-27 (Test Ea, Unpackaged Shock): 50 g
Emissions	CISPR 11: Group 1, Class A
ESD immunity	IEC 61000-4-2: 6 kV contact discharges 8 kV air discharges
Radiated RF immunity	IEC 61000-4-3: 10V/m with 1 kHz sine-wave 80% AM from 80...2000 MHz 10V/m with 200 Hz 50% pulse 100% AM at 900 MHz 10V/m with 200 Hz 50% pulse 100% AM at 1890 MHz 3V/m with 1 kHz sine-wave 80% AM from 2000...2700 MHz

Environmental (Continued)

Attribute	Value
EFT/B immunity	IEC 61000-4-4: ±4 kV at 5 kHz on power ports ±3 kV at 5 kHz on communications ports
Surge transient immunity	IEC 61000-4-5: ±1 kV @ line-line (DM) and ±2 kV @ line-earth (CM) on power ports ±2 kV @ line-earth (CM) on communications ports
Conducted RF immunity	IEC 61000-4-6: 10V rms with 1 kHz sine-wave 80% AM from 150...80000 kHz

Certifications

Certification (when product is marked)⁽¹⁾	Value
CE	European Union 2004/108/EC EMC Directive, compliant with: EN 61000-6-2; Industrial Immunity EN 61000-6-4; Industrial Emissions EN 61131-2; Programmable Controllers (Clause 8, Zone A & B) EN 61326-1; Meas./Control/Lab., Industrial Requirements
C-Tick	Australian Radiocommunications Act, compliant with: AS/NZS CISPR 11; Industrial Emissions
EtherNet/IP	ODVA conformance tested to EtherNet/IP specifications

⁽¹⁾ See the Product Certification link at <http://www.ab.com> for Declarations of Conformity, Certificates, and other certification details.

Notes:

Notes:

Rockwell Automation Support

Rockwell Automation provides technical information on the Web to assist you in using its products. At <http://support.rockwellautomation.com>, you can find technical manuals, a knowledge base of FAQs, technical and application notes, sample code and links to software service packs, and a MySupport feature that you can customize to make the best use of these tools.

For an additional level of technical phone support for installation, configuration, and troubleshooting, we offer TechConnect support programs. For more information, contact your local distributor or Rockwell Automation representative, or visit <http://support.rockwellautomation.com>.

Installation Assistance

If you experience a problem within the first 24 hours of installation, please review the information that's contained in this manual. You can also contact a special Customer Support number for initial help in getting your product up and running.

United States	1.440.646.3434 Monday – Friday, 8 a.m. – 5 p.m. EST
Outside United States	Please contact your local Rockwell Automation representative for any technical support issues.

New Product Satisfaction Return

Rockwell Automation tests all of its products to ensure that they are fully operational when shipped from the manufacturing facility. However, if your product is not functioning and needs to be returned, follow these procedures.

United States	Contact your distributor. You must provide a Customer Support case number (see phone number above to obtain one) to your distributor in order to complete the return process.
Outside United States	Please contact your local Rockwell Automation representative for the return procedure.

Allen-Bradley, Rockwell Automation, TechConnect, and ArmorPoint are trademarks of Rockwell Automation, Inc. Trademarks not belonging to Rockwell Automation are property of their respective companies.

www.rockwellautomation.com

Power, Control and Information Solutions Headquarters

Americas: Rockwell Automation, 1201 South Second Street, Milwaukee, WI 53204-2496 USA, Tel: (1) 414.382.2000, Fax: (1) 414.382.4444
Europe/Middle East/Africa: Rockwell Automation, Vorstlaan/Boulevard du Souverain 36, 1170 Brussels, Belgium, Tel: (32) 2 663 0600, Fax: (32) 2 663 0640
Asia Pacific: Rockwell Automation, Level 14, Core F, Cyberport 3, 100 Cyberport Road, Hong Kong, Tel: (852) 2887 4788, Fax: (852) 2508 1846

Publication 1738-IN028B-EN-E - February 2010

Supersedes Publication 1738-IN028A-EN-E - April 2009

Copyright © 2010 Rockwell Automation, Inc. All rights reserved.