



Visualization Solutions

PanelView Terminals (including ArmorView Plus 7 Terminals) and Industrial Computers, Monitors, and Thin Clients



Allen-Bradley

by ROCKWELL AUTOMATION

Selection Guide

Original Instructions

What's Inside

Topic	Page
What's New	2
Add Visualization to Your Control System	3
PanelView 5310 Terminals	17
PanelView 5510 Terminals	19
ArmorView Plus 7 Terminals	21
PanelView Plus 7 – Performance Terminals	23
PanelView Plus 7 – Standard Terminals	27
PanelView Plus 6 – 700, 1000, 1250, and 1500 Terminals	29
PanelView Plus 6 – 400 and 600 Terminals	33
PanelView Plus 6 – Compact Terminals	35
MobileView Tethered Operator Terminals	37
PanelView 800 Terminals	39
PanelView Terminal Accessories	41
VersaView 5000 Computers	59
6181P Integrated Display Computers	63
Hazardous Location Computers	69
Non-display Computers	71
VersaView 5100 Monitors	73
Industrial Monitors	75
Industrial Computer Accessories	77
HMI Software	85

This selection guide is meant to help you make initial decisions for the visualization products that are best suited for your system requirements. For detailed technical specifications, certifications, and environmental specifications, see the documentation links on the front cover of this selection guide.

For assistance and validation in final product selections, consider using the Configuration and Selection tools available at <http://www.rockwellautomation.com/en/e-tools/index.html>.

What's New

To help you optimize productivity, Rockwell Automation is expanding its product line by introducing the conformal coating option for all PanelView® 5310 and 5510 terminal sizes. For more information about these terminals, including complete technical specifications, certifications, and environmental specifications, see the PanelView 5310 Terminals Specifications Technical Data, publication [2713P-TD001](#), and the PanelView 5510 Terminals Specifications Technical Data, publication [2715P-TD001](#).

Add Visualization to Your Control System

As a machine builder or end user, you design control solutions with an eye toward how to improve safety, achieve higher levels of performance and efficiency, and better integrate with the rest of the manufacturing operation. To achieve these goals, you need a scalable, modular control system that offers safety, throughput, and information management capabilities to match the requirements of each application.

Visualization products from Rockwell Automation comprise a suite of scalable HMI software and operator interface hardware that provide plant floor machine operators, supervisors, engineers, and business managers a window to critical data and production and process information. All of this information can be obtained from the plant floor and displayed on a local HMI or remotely on a web browser.

Whether it's a machine-level or site-level HMI, a Windows CE platform, a smaller component HMI, or an industrial computer, Rockwell Automation has a portfolio of visualization solutions to match your system requirements. Use the following tables to help you decide which products to use.

To control a machine, consider these options	
If you want to use...	Consider this product line...
Open architecture with your own software:	VersaView® 5200 Thin Client
Small or Medium Computers	VersaView 5400
Large Computers	6181P or 6177R
Hazardous Location Computers	6181X
Display-only Monitors	VersaView 5100 6176M 6186M
Small HMI Systems	PanelView® 5310 PanelView 800 PanelView Plus 7 Standard PanelView Plus 6 Compact
Medium or Large HMI Systems	PanelView Plus 6 ArmorView™ Plus 7 Panelview Plus 7 Performance PanelView 5510 Mobile View

To control a site, consider these options	
If you want to use...	Consider this product line...
Display-only Monitors	VersaView 5100 6176M 6186M
Thin Client	VersaView 5200 Thin Client
Small or Medium Computers	VersaView 5400
Large Computers	6181P or 6177R
Hazardous Location Computers	6181X

In addition, consider the following questions, along with the PanelView Terminal Comparison table on [page 4](#), and the configuration diagrams beginning on [page 10](#), to guide your selection:

- Which controller and communication network are you connecting to?
- Which development environment (runtime version) does the terminal need to support?
- Which terminal size and screen count do you need?
- How many controllers and alarms do you need?
- Which features are required and desired?

PanelView HMI Terminals

This table provides a quick glance at comparisons between the different PanelView HMI terminal platforms. Information about the PanelView Plus 7 Performance terminals also applies to the ArmorView Plus 7 product, which contains a PanelView Plus 7 Performance terminal.

PanelView Terminal Comparison

	PanelView 5510	PanelView 5310	PanelView Plus 7 Performance	PanelView Plus 7 Standard	MobileView™	PanelView 800	PanelView Plus 6 (End of Life)	PanelView Plus 6 Compact (End of Life)
Connectivity								
CompactLogix® 5570 and ControlLogix® 5570 (L7) Controllers	Yes (Studio 5000, v27+)	Yes (Studio 5000, v27+)	Yes	Yes	Yes	L1, L2, L3 ^(S)	Yes	Yes
CompactLogix 5380 (L3) & ControlLogix 5580 (L8) Controllers	Yes (Studio 5000, v29+)	Yes (Studio 5000, v29+)	Yes	Yes	Yes	-	Yes	Yes
CompactLogix 5480	Yes (Studio 5000, v31+)	Yes (Studio 5000, v31+)	Yes	Yes	Yes	Yes	Yes	Yes
PIC-5/SIC Controllers - Ethernet	-	-	-	-	-	Yes	Yes	Yes
PIC-5/SIC/MicroLogix™ Controllers - Serial (DFT)	-	-	-	-	-	Yes	Yes	Yes
PIC-5/SIC Controllers - DH+ / ControlNet	-	-	-	-	-	-	Yes	-
Micro800™ Controllers	-	-	Yes	Yes	Yes	Yes	Yes	Yes
Third-Party Controllers	-	-	Yes	Yes	Yes	-	Yes	Yes
Development Environment								
Studio 5000™ Environment	v30+ (View Designer v4+)	v30+ (View Designer v4+)	-	-	-	-	-	-
FactoryTalk® ME Software	-	-	3.2, 4.5, 6, 7, 8, 9, x	5.1, 6, 7, 8, 9, x	3.2, 4.5, 6, 7, 8, 9, x	7, 8, 9, x, 10, x, 11, x, 12, x	3.2, 4.5, 6, 7, 8, 9, x	5.1, 7, 8, 9, x
Connected Components Workbench™ Software	-	-	-	-	-	-	-	-
Scale								
Screen Size (Rounded Inches)	7, 7W, 9W, 10, 12W, 15, 19	6, 7W, 9W, 10, 12W	7, 9W, 10, 12W, 15, 19	4W, 6, 7, 9W, 10, 12W, 15	10W	4, 7, 10	4, 6, 7, 10, 12, 15	4, 6, 10
Screen Count / Controllers / Alarms	100/4/4000 ⁽¹⁾	100/1/4000	No limit (based on memory and CPU)	100/1/500 ⁽⁴⁾	No limit (based on memory and CPU)	50/1/400	No limit (based on memory and CPU)	25/1/200
High Performance Features								
High Speed on Screen Buttons	Yes	Yes	-	-	-	-	-	-
Scalable Vector Graphics	Yes	Yes	-	-	-	-	-	-
Property Binding	Yes	Yes	-	-	-	-	-	-
Automatic Rescaling	Yes	Yes	-	-	-	-	-	-
Alignment Guides	Yes	Yes	-	-	-	-	-	-
Events and Commands	Yes (View Designer v6+)	Yes (View Designer v6+)	-	-	-	-	-	-
Navigation Button with on Screen Pop-up Menu	Yes (Hard)	Yes (Soft)	-	-	-	-	-	-
Prefined controller/network/terminal status screens	Yes	Yes	-	-	-	-	-	-
Smart Runtime Error Notifications	Yes	Yes	-	-	-	-	-	-

PanelView Terminal Comparison (Continued)

	PanelView 5510	PanelView 5310	PanelView Plus 7 Performance	PanelView Plus 7 Standard	MobileView	PanelView 800	PanelView Plus 6 (End of Life)	PanelView Plus 6 Compact (End of Life)
Alarming								
HMI-based Alarms	Future	Future	Yes	Yes	Yes	Yes	Yes	Yes
Automatic display of Logic-based Alarms	Yes	Yes	-	-	-	-	-	-
Datalogging								
HMI-based Datalog	Yes (View Designer v4+)	Yes (View Designer v4+)	With CSV Export	With CSV Export	With CSV Export	With CSV Export	With CSV Export	With CSV Export
Graphics								
High Resolution and Wide Screens	Yes	Yes	Yes	Yes	Yes	Yes	-	-
Custom Graphic Reuse	Yes	Yes	Yes	Yes	Yes	Yes	Yes	Yes
Vector Graphics	Yes	Yes	-	-	-	-	-	-
Display Import / Export	Future	Future	Yes	Yes	Yes	-	Yes	Yes
Faceplates	Yes (View Designer v4+)	Yes (View Designer v4+)	Yes	Yes	Yes	Yes	Yes	Yes
Display Reuse with Parameters	Yes	Yes	Yes	Yes	Yes	-	Yes	Yes
Animation	Yes	Yes	Yes	Yes	Yes	-	Yes	Yes
Portrait / Landscape Display Mode	Future	Future	Yes	-	-	Yes	-	-
Multi-language Support								
Language Switching	Yes	Yes	Yes	Yes	Yes	Yes	Yes	Yes
Localized Keyboard	Future	Future	Yes	Yes	Yes	-	Yes	Yes
Remote Access								
Web HMI Server (Remote Viewing / Control)	Future - Remote client support	Future - Remote client support	FactoryTalk Viewpoint	FactoryTalk Viewpoint	-	-	FactoryTalk Viewpoint	FactoryTalk Viewpoint
WIC Server	Yes (View Designer v4+)	Yes (View Designer v4+)	Yes	Yes	Yes - can be installed	Yes	Yes	Yes
FTP Server	-	-	Yes	Yes	Yes - can be installed	Yes (not applicable to CompactLogix controller)	Yes	Yes
Remote Desktop Client	-	-	Yes	Yes	Yes	-	Yes	Yes
WIC Client	-	-	Yes	Yes	Yes - can be installed	-	Yes	Yes
Other								
Device Level Ring	Yes	-	Yes	Optional	-	-	-	-
ActiveX Controls	-	-	Yes	Yes	Yes	-	Yes	Yes
Enhanced Write Filter	-	-	-	-	Yes	-	-	-
Emulator	Yes (View Designer v4+)	Yes (View Designer v4+)	Yes	Yes	Yes	-	Yes	Yes
USB Input	Yes	Yes	Yes	Yes	Yes	Yes	Yes	Yes
Backup / Restore / Cloning	Load project and firmware from media (View Designer v6+)	Load project and firmware from media (View Designer v6+)	Yes	Yes	Yes	Yes	Yes	Yes
Operating system	None	None	Windows CE 6.0 (2)	Windows CE 6.0 (2)	Microsoft Windows Embedded Standard 7, SP1	None	Windows CE 6.0 (2)	Windows CE 6.0 (2)
Desktop	None	None	Secured Desktop Access	Secured Desktop Access	None	None	Secured Desktop Access	Secured Desktop Access
SD Card	Yes	Yes	Yes	Yes	Yes (internal only)	Yes	Yes	Yes
Power	DC	DC	AC or DC(3)	DC	DC	DC	AC or DC	DC
Recipes								
Recipe Manager	Logic based	Logic based	Yes	Yes	Yes	Yes	Yes	Yes
Macros	-	-	Yes	Yes	Yes	-	Yes	Yes

PanelView Terminal Comparison (Continued)

	PanelView 5510	PanelView 5310	PanelView Plus 7 Performance	PanelView Plus 7 Standard	MobileView	PanelView 800	PanelView Plus 6 (End of Life)	PanelView Plus 6 Compact (End of Life)
Reporting								
Email	Yes (View Designer v6+)	Yes (View Designer v6+)	Yes	Yes	Yes	Yes (not applicable to Compact Logix controller)	Yes	Yes
Security								
Local Users	Yes	Yes	Yes	Yes	Yes	Yes	Yes	Yes
FactoryTalk Software Users	-	-	Yes	Yes	Yes	-	Yes	Yes
Microsoft Active Directory Users	-	-	Yes	Yes	Yes	-	Yes	Yes
Tags								
Logix Tag Extended Properties	Yes	Yes	-	-	-	-	-	-
Direct Reference Tags	Yes	Yes	Yes	Yes	Yes	Micro800 only	Yes	Yes
HMI Tags	-	-	Yes	Yes	Yes	Yes	Yes	Yes
Trending								
Real-time Trending	Yes	Yes	Yes	Yes	Yes	Yes	Yes	Yes
Historical Trending	Yes (View Designer v4+)	Yes (View Designer v4+)	Yes	Yes	Yes	-	Yes	Yes
Troubleshooting								
Smart Runtime Error Notifications	Yes	Yes	-	-	-	-	-	-
Device Diagnostic Screens (PLC and HMI)	Yes	Yes	Faceplates + ActiveX control	Faceplates + ActiveX control	Faceplates + ActiveX control	Faceplates + ActiveX control	Faceplates + ActiveX control	Faceplates + ActiveX control
Viewers								
PDF	Yes (View Designer v4+)	Yes (View Designer v5+)	Yes	Yes	Yes	-	Yes	Yes
Excel	-	-	Yes	-	-	-	Optional	-
PowerPoint	-	-	Yes	-	-	-	Optional	-
Word	-	-	Yes	-	-	-	Optional	-
Web Browser	Future	-	Yes	-	Yes	-	Optional	-
Media Player	Future	-	Yes	-	-	-	Optional	-
Certifications								
Major Certifications	cULus; CE; KCC; RCM; RoHS; EAC	cULus; CE; KCC; RCM; RoHS; EAC	cULus; CE; KCC; RCM; RoHS	cULus; CE; KCC; RCM; RoHS; EAC	cULus; CE; RCM; RoHS	cULus; CE; KCC; RCM; RoHS	cULus; CE; KCC; RCM; RoHS	cULus; CE; KCC; RCM; RoHS
Hazardous Locations	Class I Div 2	-	Class I Div 2	IECx, CCC Ex, Class I Div 2; ATEX Zone 2, 22	-	-	Class I Div 2	Class I Div 2
INMETRO	-	-	-	Yes	-	-	-	-
Marine Certification	Yes	-	-	-	-	Yes	Yes	-
Modified Terminals								
Conformal Coating	7 in., 7 in. (wide), 9 in. (wide), 10 in., 12 in. (wide), 15 in., 19 in.	6 in., 7 in. (wide), 9 in. (wide), 10 in., 12 in. (wide)	Touch Models 7 in., 9 in. (wide), 10 in., 12 in. (wide), 15 in., 19 in. Touch/Keypad Model 15 in.	-	-	-	7 in., 12 in.	-
High Bright Display	Future	-	12 in. (wide) ArmorView	-	-	-	12 in.	-
On-Machine	Future	-	9 in. (wide) Brandless	-	-	-	-	-
Stainless Steel	Future	-	12 in. (wide) Brandless	-	-	-	-	-
Illuminated E-stop	-	-	-	-	Gen 2 Only	-	-	-
Configurable Junction Box ID	-	-	-	-	Gen 2 Only	-	-	-

PanelView Terminal Comparison (Continued)

	PanelView 5510	PanelView 5310	PanelView Plus 7 Performance	PanelView Plus 7 Standard	MobileView	PanelView 800	PanelView Plus 6 (End of Life)	PanelView Plus 6 Compact (End of Life)
Display	LED backlight LCD, 24-bit 16.7M colors, widescreen options	LED backlight LCD, 24-bit 16.7M colors, widescreen options	LED backlight LCD, 262K colors, widescreen options	LED backlight LCD, 262K colors, widescreen options	LED backlight LCD, 262K colors	LED backlight LCD, 65K colors, widescreen options	LED backlight LCD, 262K colors, grayscale options	LED backlight LCD, 262K colors, grayscale options
Input type	touch screen keypad/ touchscreen	touch screen	touch screen keypad/ touch screen	touch screen	Function key/ touch	touch screen touch screen + 4 keys	keypad touch screen keypad/ touch screen	keypad touch screen keypad/ touch screen
Communication	EtherNet/IP with DLR support	EtherNet/IP	EtherNet/IP with DLR support Keeware Server available to support third-party Ethernet protocols.	EtherNet/IP with optional DLR support Keeware Server available to support third-party Ethernet protocols.	EtherNet/IP	EtherNet/IP, DF1, and DH-485 Third-party communications: Modbus ASCII, Modbus RTU (Master and Slave/Unsolicted), and Modbus TCP.	EtherNet/IP, DF1 (RS-232), and DH-485 (RS-232). Keeware Server available to support third-party Ethernet and RS-232 protocols (Modbus TCP/RTU).	EtherNet/IP, DF1 (RS-232), and DH-485 (RS-232). Keeware Server available to support third-party Ethernet and RS-232 protocols (Modbus TCP/RTU).
User storage	1 GB RAM and 1 GB user storage	1 GB RAM and 1 GB user storage	512 MB RAM and 512 MB storage Approx. 80 MB nonvolatile storage for applications	512 MB RAM and 512 MB storage Approx. 80 MB nonvolatile storage for applications	4 GB DRAM/32 GB Flash	256 MB RAM and 256 MB storage	400 and 600 only—256 MB RAM/512 MB nonvolatile memory (approx. 73 MB free user memory) 1000 only—512 MB RAM/512 MB nonvolatile memory (approx. 79 MB free user memory)	400 and 600 only—256 MB RAM/512 MB nonvolatile memory (approx. 73 MB free user memory) 1000 only—512 MB RAM/512 MB nonvolatile memory (approx. 79 MB free user memory)
More information	page 19	page 17	page 23	page 22	page 27	page 29	page 28 and page 33	page 25

(1) The PanelView 5510 can support up to 4000 Logix tag-based alarms or up to 1000 Logix instruction-based alarm per controller. Use Logix Designer v3.2 or later for Logix tag-based alarms.

(2) Windows CE 6.0 operating system supports these features: FTP Server, WNC client/server, PDF reader, Active X controls, third-party device support.

(3) The ArmorView Plus 7 product is available only with the DC version of the PanelView Plus 7 Performance terminal.

(4) FactoryTalk View Machine Edition v11 or newer.







(5) Only applies to CompactLogix 5370, excluding L37 and L38.

Industrial Computers and Thin Clients

Rockwell Automation® industrial computers and monitors are built with high-grade components that are critical to the safety and success of applications in demanding industrial environments:

- Seamless integration with the full suite of Rockwell Software® solutions, including the Integrated Architecture® platform and FactoryTalk® View software
- Utilities for system backup and restore, hardware analysis, and troubleshooting
- Unit-level immediate exchange program to reduce downtime

If you need the processing power of an industrial computer with open-desktop and modern operating-system support, choose from the following options:

VersaView 5000 Computers	VersaView 5200 ThinManager® Thin Clients	6181P Integrated-Display Industrial Computers	Hazardous Location Computers	Non-Display Computers	VersaView® 5100 Monitors	Industrial Monitors
						
<p>Complete line of open architecture industrial PCs, and monitors. The open architecture supports modern operating systems and various software applications. Available in both compact non-display and integrated-display versions. Ideal for standard HMI applications.</p>	<p>Integrated display and non-display ThinManager thin clients that are designed to deliver content in harsh industrial environments.</p>	<p>Select models with and without displays for high performance applications. Ideal for complex and large HMI applications with integrated displays.</p>	<p>Extreme environment computers that combine safety with extended operating temperature ratings. These computers are designed to endure the harsh extremes of heat and cold.</p>	<p>Machine or rack-mount computers for applications where you do not need a display. The focus of these computers is on expandability. Ideal for complex and large HMI applications with external displays.</p>	<p>All widescreen industrial monitors that provide modern connectivity with full HD options. These monitors feature native DisplayPort, DVI, and VGA connectivity to a variety of computing devices.</p>	<p>Standard and Performance options for when you need a Class 1 Div 2 rated industrial monitor to enhance your system.</p>
<p>page 61</p>	<p>page 59</p>	<p>page 63</p>	<p>page 69</p>	<p>page 71</p>	<p>page 73</p>	<p>page 75</p>

PanelView HMI Terminals

PanelView™ 5310 terminals, PanelView 5510 terminals, PanelView Plus 7 Performance terminals, PanelView Plus 7 Standard terminals, PanelView Plus 6 terminals, MobileView™ tethered operator terminals, PanelView 800 terminals, Studio 5000 View Designer®, FactoryTalk® View Machine Edition, and FactoryTalk View Site Edition provide premier integration in a number of ways:

- Reduced programming time with Logix native addressing and the ability to browse directly to Logix tags without creating a separate database.
- Simplified interaction of all networks with support for all Core Integrated Architecture® CIP™ networks including EtherNet/IP™, ControlNet, and numerous other drivers.
- Simplified development time with pre-engineered, pre-tested faceplates for specific motion, drives, and process applications.

PanelView HMI terminals are available with the following levels of control:

- Component Class
- Small Control Class
- Integrated Architecture Class

Component Class

This class combines a simple, powerful control core, a full suite of associated components, and a dedicated set of class-leading application development tools. These features provide enough control to meet machine control and end-customer requirements in the shortest possible time.

Typical Configurations

Micro800® with PanelView 800

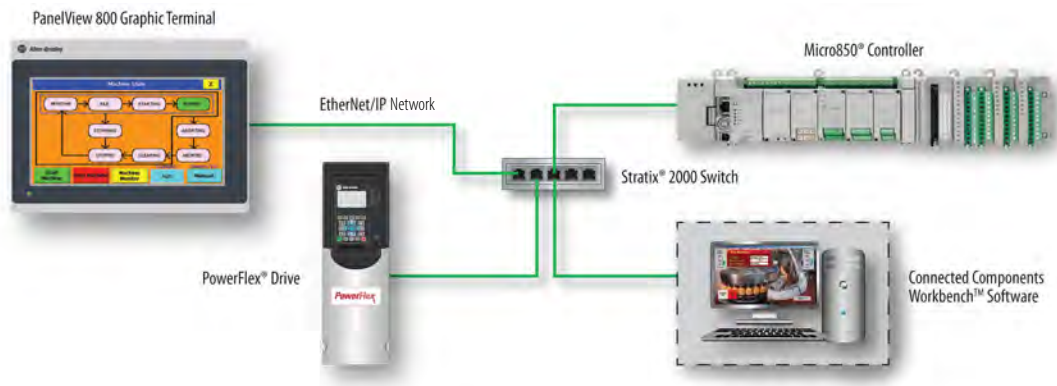

Small Control Class

This scalable control system helps machine builders and their customers cost-effectively match their application needs and standardize on one control platform while receiving real-time information for smaller applications.

Typical Configurations

The following configurations are typically used in the midrange class:

- Star configuration
- Linear configuration
- Device Level Ring configuration

Star Configuration

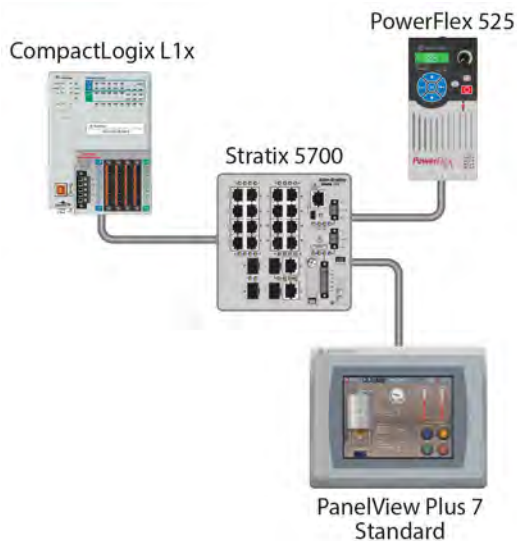

Linear Configuration

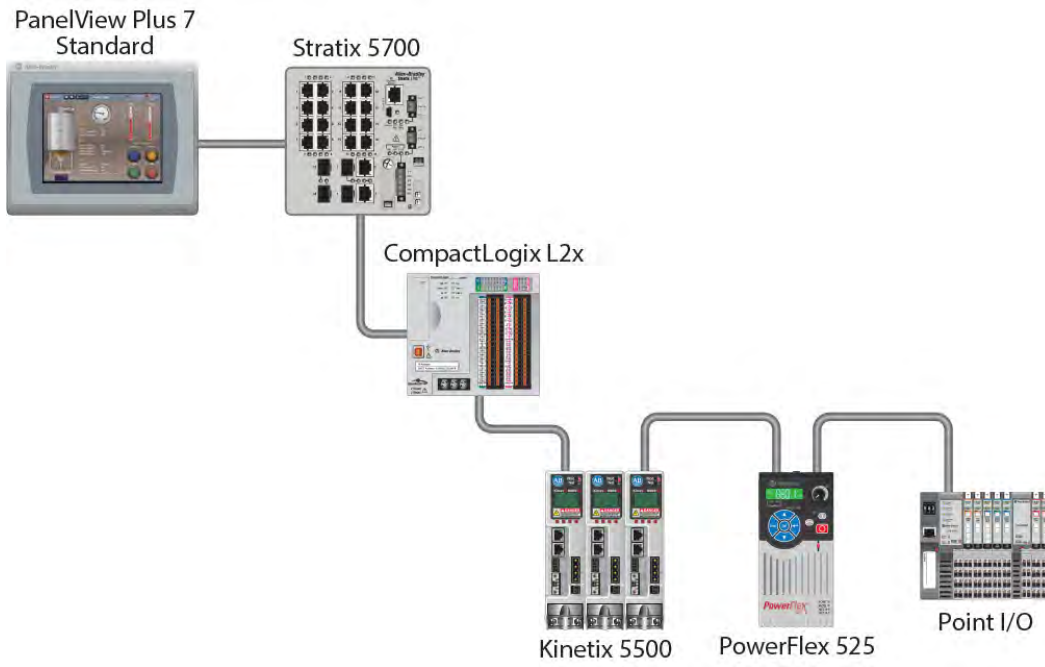

Device Level Ring Configuration

The PanelView Plus 7 standard terminal and the CompactLogix™ 5370 controller provide an integrated, Device Level Ring (DLR) capable solution for mid-size applications. Typically, these applications are machine-level control applications that require smaller I/O quantities and benefit from EtherNet/IP communication capabilities. PanelView Plus 7 Performance terminals come with DLR and PanelView Plus 7 Standard terminals have DLR only as an option.

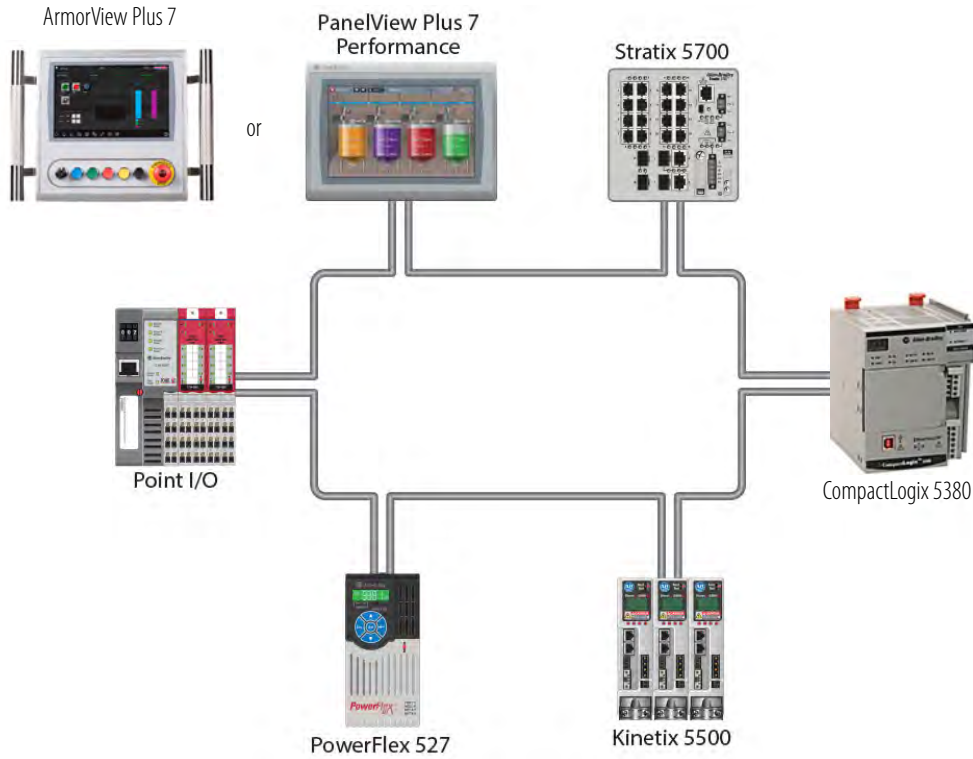

Integrated Architecture Class

The Integrated Architecture™ system is unique in that it offers scalable, integrated safety, motion control, and visualization capabilities that are ideal for machine builders and end users who want one control and development environment, regardless of the application size or complexity. Large control systems integrate all control disciplines - process batch, discrete, drives, safety, and motion - into one connected and segmented, plant-wide infrastructure that uses a common design environment for all automation disciplines.

Typical Configurations

The following configurations are typically used in the integrated architecture class:

- Star configuration
- Linear configuration
- Device Level Ring configuration

Star Configuration

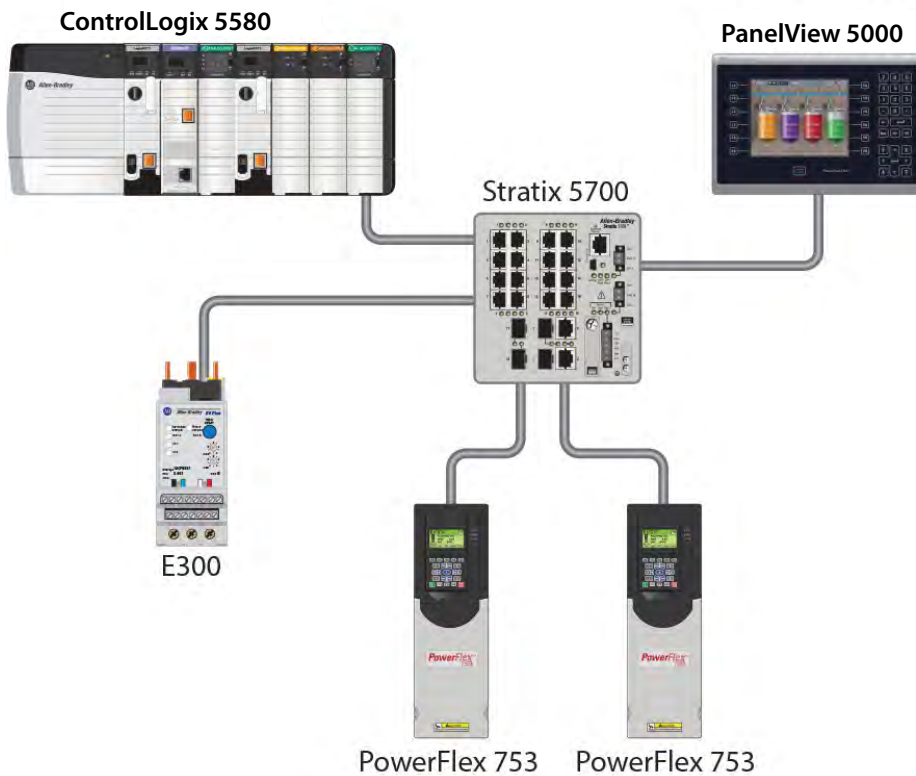

Linear Configuration

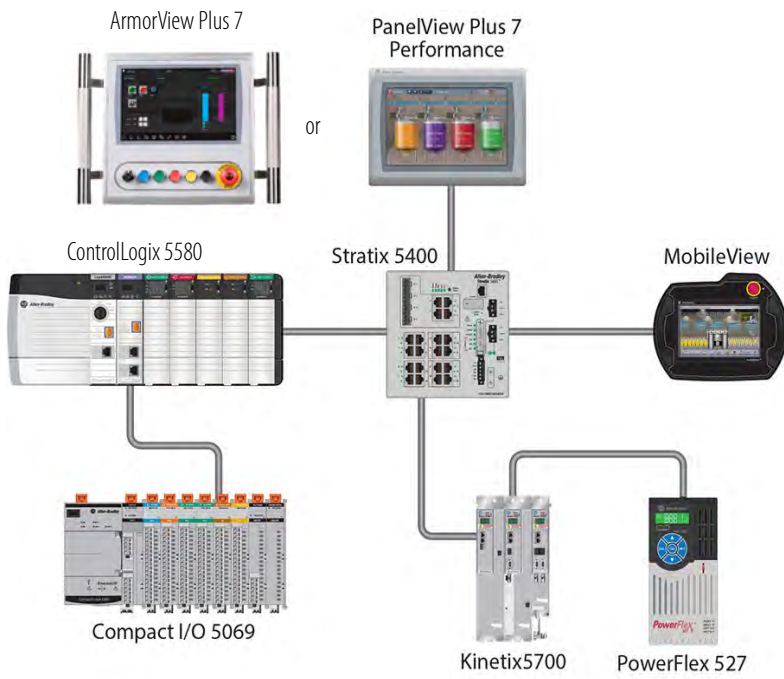

Device Level Ring Configuration

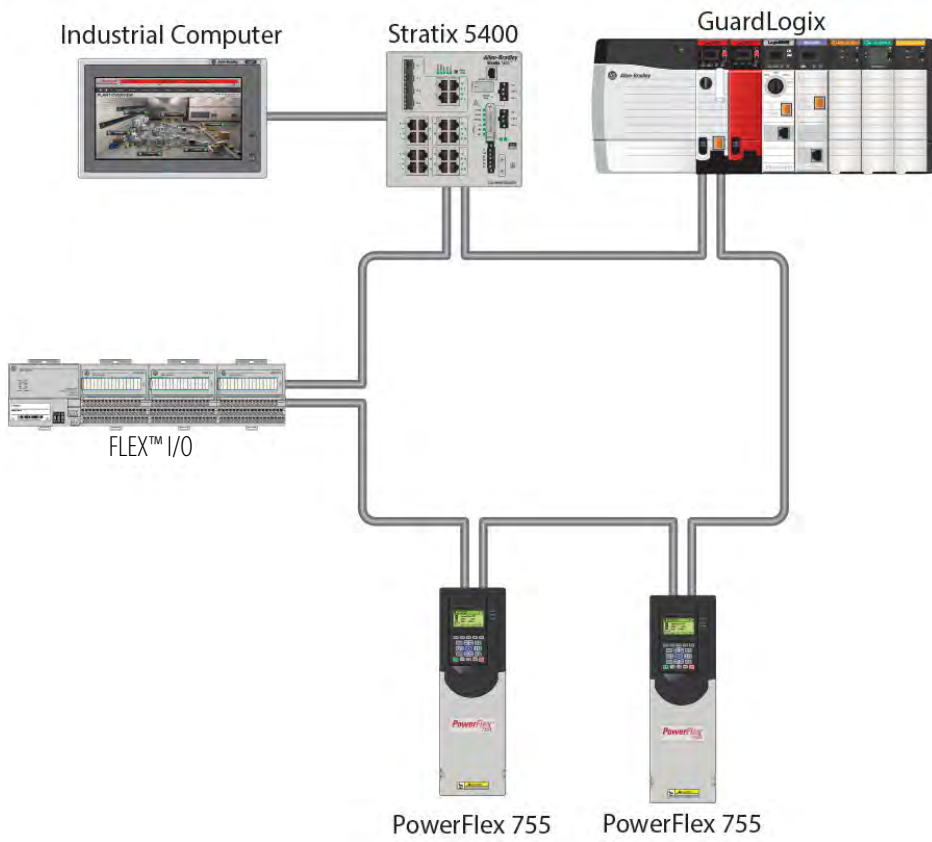

PanelView 5310 Terminals



PanelView™ 5310 terminals are operator interface terminals for small- to medium-sized applications. They monitor and control devices that are attached to ControlLogix® 5570, 5580 controllers, and CompactLogix™ 5370, 5380 and 5480 controllers over an EtherNet/IP™ network. Animated graphic and text displays provide operators a view into the operating state of a machine or process. Operators interact with the control system by using the touch screen.

Features include the following:

- Tightly-integrated control and design environment for information sharing between the terminal and the Logix platforms
- Studio 5000® environment provides one point of access for both Studio 5000 View Designer® and Studio 5000 Logix Designer® applications
- Connection to one ControlLogix 5570, 5580 or one CompactLogix 5370, 5380 or 5480 controller running V27 firmware or later over an EtherNet/IP network
- Supports up to 100 displays in the application
- Supports up to 4000 Logix-based alarms
- Conformal coating available for all terminal sizes.

Terminal Features

Features	Description
High memory capacity	1 GB RAM and 1 GB user storage
Power input	DC
Communication ports	One 10/100Base-T, Auto MDI/MDI-X, Ethernet/IP port for controller communication
USB ports	One USB high-speed 2.0 host port (type A) support removable flash drive for external storage
Secure Digital (SD) card slot	One SD card slot
Software	Studio 5000 environment provides single portal to View Designer and Logix Designer applications
Preferred controller	ControlLogix 5570, 5580 controllers, and CompactLogix 5370, 5380 and 5480 controllers

For complete technical specifications, certifications, and environmental specifications on the PanelView 5310 terminals, refer to the PanelView 5310 Specifications Technical Data, publication [2713P-TD001](#).

Terminal Selection

Model	Cat. No.	Color Display		Input Power	Brandless
		Size	Input		
6 in.	2713P – T6CD1	6 in.	Touch	DC	
	2713P – T6CD1-B				X
	2713P – T6CD1-K ⁽¹⁾				
7 in. (wide)	2713P – T7WD1	7 in. (wide)			
	2713P – T7WD1-B				X
	2713P – T7WD1-K ⁽¹⁾				
9 in. (wide)	2713P – T9WD1	9 in. (wide)			
	2713P – T9WD1-B				X
	2713P – T9WD1-K ⁽¹⁾				
10 in.	2713P – T10CD1	10 in.			
	2713P – T10CD1-B				X
	2713P – T10CD1-K ⁽¹⁾				
12 in. (wide)	2713P – T12WD1	12 in. (wide)			
	2713P – T12WD1-B		X		
	2713P – T12WD1-K ⁽¹⁾				

(1) This model includes conformal coating.

For information about accessories that are available for these terminals, see page [41](#).

PanelView 5510 Terminals



The PanelView™ 5510 terminals are operator interface devices that monitor and control devices attached to ControlLogix® 5570, 5580 controllers, and CompactLogix™ 5370, 5380 and 5480 controllers over an EtherNet/IP™ network. Animated graphic and text displays provide a view to operators into the operating state of a machine or process. Operators interact with the control system by using the touch screen or keypad of the terminal.

Features include the following:

- Tightly integrated control and design environment allows information to be shared between the PanelView 5510 terminal and the Logix platforms.
- The Studio 5000® environment provides one point of access for the Studio 5000 View Designer® and Studio 5000 Logix Designer® applications.⁽¹⁾
- Connection up to four ControlLogix 5570, 5580 and CompactLogix 5370, 5380 or 5480 controllers running V27 firmware or later over an EtherNet/IP network
- Supports a maximum of 100 user-defined screens.
- Supports a maximum of 4,000 Logix tag-based alarms or 1000 Logix instruction-based alarms per controller.⁽¹⁾
- Ethernet communication that supports Device Level Ring (DLR), linear, or star network topologies.
- High-speed human machine interface (HMI) button control and easily configured navigation menu.
- Conformal coating available for all terminal sizes.

Terminal Features

Features	Description
High memory capacity	1 GB RAM and 1 GB nonvolatile storage for projects
Power input	DC
Communication ports	Two 10/100Base-T, Auto MDI/MDI-X Ethernet ports that support (Device Level Ring) DLR, linear, or star network topologies.
USB ports	Two USB 2.0 high-speed (type A) host ports to support removable USB drives for external storage. One USB 2.0 high-speed (type B) device port to connect to a host computer that is software-feature dependent.
Software	Studio 5000 environment provides single portal to View Designer and Logix Designer applications
Preferred controller	ControlLogix 5570, 5580 controllers, and CompactLogix 5370, 5380 and 5480 controllers

For complete technical specifications, certifications, and environmental specifications on the PanelView 5510 terminals, see the PanelView 5510 Terminals Specifications Technical Data, publication [2715P-TD001](#).

⁽¹⁾ The PanelView 5510 terminal can support up to 4000 Logix tag-based alarms or up to 1000 Logix instruction-based alarms per controller. Use Logix Designer v. 32 or later for Logix tag-based alarms. Use View Designer v. 6 and later for 4000 alarms per controller. Earlier versions only supported up to 4000 alarms total.

Terminal Selections

Model	Cat. No.	Color Display		Input Power	Brandless
		Size	Input		
6.5-in.	2715P-T7CD	6.5-in.	Touch	DC	
	2715P-T7CD-B				
	2715P-T7CD-K ⁽¹⁾				
	2715P-B7CD		Touch with keypad		
	2715P-B7CD-B				x
	2715P-B7CD-K ⁽¹⁾				
7-in.	2715P-T7WD	7-in.	Touch		
	2715P-T7WD-B			x	
	2715P-T7WD-K ⁽¹⁾				
9-in.	2715P-T9WD	9-in.	Touch		
	2715P-T9WD-B			x	
	2715P-T9WD-K ⁽¹⁾				
10.4-in.	2715P-T10CD	10.4-in.	Touch		
	2715P-T10CD-B			x	
	2715P-T10CD-K ⁽¹⁾				
	2715P-B10CD		Touch with keypad		
	2715P-B10CD-B			x	
	2715P-B10CD-K ⁽¹⁾				
12.1-in.	2715P-T12WD	12.1-in.	Touch		
	2715P-T12WD-B			x	
	2715P-T12WD-K ⁽¹⁾				
15-in.	2715P-T15CD	15-in.	Touch		
	2715P-T15CD-B			x	
	2715P-T15CD-K ⁽¹⁾				
	2715P-B15CD		Touch with keypad		
	2715P-B15CD-B			x	
	2715P-B15CD-K ⁽¹⁾				
19-in.	2715P-T19CD	19-in.	Touch		
	2715P-T19CD-B			x	
	2715P-T19CD-K ⁽¹⁾				

(1) This model includes conformal coating.

For information about accessories that are available for these terminals, see page [41](#).

ArmorView Plus 7 Terminals



The ArmorView™ Plus 7 terminal, which ships with an arm mount adapter, can be mounted on an arm mount system, a wall, or a pedestal. An optional VESA kit is available for operators who prefer to mount the terminal on a VESA-compatible bracket (purchased separately). If operators choose the VESA mount, they must install an I/O plate (included with the VESA kit) in place of the arm mount adapter.

The ArmorView Plus 7 terminal is based on the PanelView™ Plus 7 Performance terminal. In addition to

the features of the PanelView Plus 7 Performance terminal that are listed on page [23](#), the ArmorView Plus 7 terminal also includes the features that are listed in the following table.

Terminal Features

Features	Description
Enclosure	Custom cast-aluminum enclosure. Provides NEMA4/IP66 ingress protection (when properly mounted).
PanelView terminal	Full-function PanelView Plus 7 Performance 12-inch wide-screen terminal with touch interface.
Button plate	Positionable below (standard), above, or to either side of the display.
Display	Landscape (standard) or portrait orientation. (Button plate on either side requires portrait display orientation).
E-stop button (pre-configured options)	Lighted, twist-to release E-stop with N.O., N.C., and self-monitoring contact blocks.
Buttons (pre-configured options)	Mix of momentary pushbuttons, two- and three-position selector switches, and three-position key selector switch with N.O. contact blocks connected to an integrated ArmorBlock Ethernet I/O module.
Buttons (customer configured)	Seven allowable locations for any 22 mm (0.87 in.) buttons, lamps, or connection ports.
Stack light (accessory, customer configured)	Two locations for stack light mounting.
Handle (accessory)	Three locations for stainless steel handle mounting.
Arm mount	Arm mount adapter mates to leading industry arm mount systems or electrical enclosures. Orientations include hanging mount, pedestal (bottom) mount, or side mount.
VESA mount (accessory)	VESA mounting to industry standard (100x100) arms and brackets. (Accessory includes I/O plate with bulkhead power, Ethernet, and E-stop connectors).

For complete technical specifications, certifications, and environmental specifications on the PanelView Plus 7 Performance terminals and the ArmorView Plus 7 terminal, refer to the PanelView Plus 7 Performance Terminals Technical Data, publication [2711P-TD009](#).

Terminal Selections

Cat. No.	Components Included with All Catalog Numbers	Additional Components Included with Individual Catalog Numbers ⁽²⁾					
		Ethernet I/O Module ⁽³⁾ (1732E-8CFG8R)	Button Plate Components ⁽⁴⁾				
			E-stop Button	# Push Buttons ⁽⁵⁾	Two-position Selector	Three-position Selector	Three-position Key Selector
2711P-T12W22D9P-BM001 ⁽¹⁾	<ul style="list-style-type: none"> ArmorView Plus 7 terminal PanelView Plus 7 Performance module Arm mount adapter Button plate Standard access cover Product Information document 						
2711P-T12W22D9P-BM002		x					
2711P-T12W22D9P-BM003			x				
2711P-T12W22D9P-BM004		x	x				
2711P-T12W22D9P-BM005		x	x	2			
2711P-T12W22D9P-BM006		x	x	2	x		
2711P-T12W22D9P-BM007		x	x	2		x	
2711P-T12W22D9P-BM008		x	x	2			x
2711P-T12W22D9P-BM009		x	x	3			
2711P-T12W22D9P-BM010		x	x	3	x		
2711P-T12W22D9P-BM011		x	x	3		x	
2711P-T12W22D9P-BM012		x	x	3			x
2711P-T12W22D9P-BM013		x	x	6			
2711P-T12W22D9P-BM014		x	x	5	x		
2711P-T12W22D9P-BM015		x	x	5		x	
2711P-T12W22D9P-BM016		x	x	5			x

(1) This catalog number represents the most basic configuration of the ArmorView Plus 7 product. It is shipped with an arm mount adapter, a blank button plate, and a standard access cover. It does not include any extra features.
 (2) All catalog numbers come with nine M4 screws (6 for the access cover and 3 for grounding the subassembly chassis) and eight wire routing clips.
 (3) The Ethernet I/O module is used to interface to the buttons on the button plate. It includes eight ports that can be configured as inputs or outputs.
 (4) All button plate components (push buttons, selector switches, and key selector switches) are 22 mm (0.87 in.) in diameter.
 (5) Catalog numbers 2711P-T12W22D9P-BM005...2711P-T12W22D9P-BM016 include nine push button key caps (assorted colors) that can be used to customize the button color and location.

For information about accessories that are available for these terminals, see page [43](#).

PanelView Plus 7 – Performance Terminals



PanelView™ Plus 7 performance terminals are operator interface terminals. They monitor and control devices attached to ControlLogix® and CompactLogix™ controllers on an EtherNet/IP network. Animated graphic and text displays provide operators a view into the operating state of a machine or process. Operators interact with the control system by using touch screen or keypad input.

Features include the following:

- FactoryTalk® View Machine Edition software provides a familiar environment for creating HMI applications.
- Windows CE operating system with desktop access for configuration and third-party applications.
- Connection to ControlLogix or CompactLogix controllers.
- Ethernet communication that can support Device Level Ring (DLR), linear, or star network topologies.
- Web browser, Microsoft file viewers, text editor, PDF viewer, remote desktop connection, and media player on the terminal desktop.
- Conformal-coating available for all DC power, touch-only terminals, and the 15-inch DC power, touch/keypad terminal.
- Stainless steel, hygienic, brandless, DC-power, and conformal-coating are available for the 9-in. wide-screen, touch-only units and the 12-in. wide-screen, touch-only units.
- On-machine mounting available for the 12-inch wide-screen, DC-powered, touch-screen PanelView™ Plus 7 performance terminal. For more information, see [ArmorView Plus 7 Terminals on page 21](#).

Terminal Features

Features	Description
High memory capacity	512 MB RAM and 512 MB storage Approx. 80 MB nonvolatile storage for applications
Power input	DC or AC
Communication ports	Two 10/100Base-T, Auto MDI/MDI-X, built-in DLR Ethernet port for controller communication
USB ports	Two USB 2.0 high-speed host port (type A) support removable flash drives for storage One high-speed 1.0 device port (type B) supports future connection to host computer
Secure Digital (SD) card slot	One SD card slot
Operating system	All terminals run the Windows CE 6.0 operating system (OS) which provides OS functionality that meets the needs of most users: <ul style="list-style-type: none"> • FTP server • VNC client/server • PDF reader • Active X controls • Third-party device support • FactoryTalk® ViewPoint
Software	FactoryTalk® View Machine Edition Station (runtime) software, version 8.0 or later, is preloaded and activated on each terminal Single license support for FactoryTalk ViewPoint software, version 1.2 or later, gives remote users access to terminal displays via a standard web browser HMI applications are developed with FactoryTalk View Studio for Machine Edition software, which is purchased separately
Preferred controller	ControlLogix

For complete technical specifications, certifications, and environmental specifications on the PanelView Plus 7 Performance terminals, refer to the PanelView Plus 7 Performance Terminals Technical Data, publication [2711P-TD009](#).

Terminal Selection

Model	TFT Color Display			Input Power	Brandless	
	Cat No.	Size	Input			
700	2711P-T7C22D9P	7-in.	Touch	DC		
	2711P-T7C22D9PK ⁽¹⁾					
	2711P-T7C22D9P-B				x	
	2711P-T7C22A9P					
	2711P-T7C22A9P-B			x		
	2711P-B7C22D9P		Touch with keypad	DC		
	2711P-B7C22D9P-B				x	
	2711P-B7C22A9P					
	2711P-B7C22A9P-B					x
2711P-B7C22A9P-B		x				
900W	2711P-T9W22D9P	9-in. (Wide)	Touch	DC		
	2711P-T9W22D9PK ⁽¹⁾					
	2711P-T9W22D9P-B				x	
	2711P-T9W22D9P-BSHK ⁽²⁾					
	2711P-T9W22A9P		AC			
	2711P-T9W22A9P-B			x		
1000	2711P-T10C22D9P	10-in.	Touch	DC		
	2711P-T10C22D9PK ⁽¹⁾					
	2711P-T10C22D9P-B				x	
	2711P-T10C22A9P					
	2711P-T10C22A9P-B		Touch with keypad	DC		
	2711P-B10C22D9P				x	
	2711P-B10C22D9P-B					
	2711P-B10C22A9P				AC	
	2711P-B10C22A9P-B					x
1200W	2711P-T12W22D9P ⁽³⁾	12-in. (Wide)	Touch	DC		
	2711P-T12W22D9PK ⁽¹⁾					
	2711P-T12W22D9P-B				x	
	2711P-T12W22D9P-BSHK ⁽²⁾					
	2711P-T12W22A9P		AC			
	2711P-T12W22A9P-B			x		
1500	2711P-T15C22D9P	15-in.	Touch	DC		
	2711P-T15C22D9PK ⁽¹⁾					
	2711P-T15C22D9P-B				x	
	2711P-T15C22A9P				AC	
	2711P-T15C22A9P-B		x			
	2711P-B15C22D9P		Touch with keypad	DC		
	2711P-B15C22D9PK ⁽¹⁾					
	2711P-B15C22D9P-B				x	
	2711P-B15C22A9P				AC	
	2711P-B15C22A9P-B					x

Terminal Selection (Continued)

Model	TFT Color Display			Input Power	Brandless
	Cat No.	Size	Input		
1900	2711P-T19C22D9P	19-in.	Touch	DC	
	2711P-T19C22D9PK ⁽¹⁾				
	2711P-T19C22D9P-B			x	
	2711P-T19C22A9P			AC	
	2711P-T19C22A9P-B				x

(1) This model includes conformal coating.

(2) No brand identity, stainless steel, hygienic, conformal coat.

(3) This model is included with the ArmorView Plus 7 product.

For information about accessories that are available for these terminals, see page [44](#).

Notes:

PanelView Plus 7 – Standard Terminals



PanelView™ Plus 7 Standard terminals are operator interface devices. They monitor and control devices that are attached to ControlLogix® and CompactLogix™ controllers on an EtherNet/IP network. Animated graphic and text displays provide operators a view into the operating state of a machine or process. Operators interact with the control system by using touch screen input.

PanelView Plus 7 Standard terminals include these features:

- Terminal functionality permits connection to 1 controller, 100 screens, and 500 alarms. This functionality was added with the FactoryTalk® View Machine Edition 11.0 release.
- FactoryTalk View Machine Edition software provides a familiar environment for creating HMI applications.
- Windows CE operating system with desktop access for configuration and third-party applications.
- Ethernet communication that supports linear, star, and ring network topologies.
- PDF viewer to access PDF files that are stored on the terminal.
- More screen options including 4-in., 6-in., 7-in., 9-in., 10-in., 12-in., and 15-in. terminals.
- Widescreen displays in three sizes: 4-in., 9-in., and 12-in. terminals.
- Greater screen resolution.
- Terminals are available with an Allen-Bradley® label, or with no label.
- Certifications including Class 1, Div 2, ATEX zones 2 and 22, IECEx, CCC Ex, and InMetro.

Terminal Features

Features	Description
High memory capacity	512 MB RAM and 512 MB storage Approx. 80 MB nonvolatile storage for applications
Power input	DC
Communication ports	Single 10/100Base-T, Auto MDI/MDI-X, Ethernet port for controller communication, or DLR
USB ports	One USB 2.0 high-speed host port (type A) support removal flash drives for storage One high-speed 1.0 device port (type B) supports connection to host computer
Secure Digital (SD) card slot	One SD card slot.
Operating system	All terminals run the Windows CE 6.0 operating system (OS) which provides OS functionality that meets the needs of most users: <ul style="list-style-type: none"> • FTP server • VNC client/server • PDF reader • Active X controls • Third-party device support • FactoryTalk® ViewPoint
Software	FactoryTalk® View Machine Edition Station (runtime) software, version 7.0 or later, is preloaded and activated on each terminal Single license support for FactoryTalk ViewPoint software, version 1.2 or later, gives remote users access to terminal displays via a standard web browser HMI applications are developed with FactoryTalk View Studio for Machine Edition software, which is purchased separately
Preferred controller	CompactLogix

For complete technical specifications, certifications, and environmental specifications on the PanelView Plus 7 Standard terminals, refer to the PanelView Plus 7 Standard Terminals Technical Data, publication [2711P-TD008](#).

Terminal Selection

Model	Color Touch Display		DLR Support	Brandless
	Cat. No.	Size		
400W	2711P-T4W21D8S	4 in. (Wide)		
	2711P-T4W21D8S-B			X
	2711P-T4W22D8S		X	
	2711P-T4W22D8S-B		X	X
600	2711P-T6C21D8S	6 in.		
	2711P-T6C21D8S-B			X
	2711P-T6C22D8S		X	
	2711P-T6C22D8S-B		X	X
700	2711P-T7C21D8S	7 in.		
	2711P-T7C21D8S-B			X
	2711P-T7C22D8S		X	
	2711P-T7C22D8S-B		X	X
900W	2711P-T9W21D8S	9 in. (Wide)		
	2711P-T9W21D8S-B			X
	2711P-T9W22D8S		X	
	2711P-T9W22D8S-B		X	X
1000	2711P-T10C21D8S	10 in.		
	2711P-T10C21D8S-B			X
	2711P-T10C22D8S		X	
	2711P-T10C22D8S-B		X	X
1200W	2711P-T12W21D8S	12 in. (Wide)		
	2711P-T12W21D8S-B			X
	2711P-T12W22D8S		X	
	2711P-T12W22D8S-B		X	X
1500	2711P-T15C21D8S	15 in.		
	2711P-T15C21D8S-B			X
	2711P-T15C22D8S		X	
	2711P-T15C22D8S-B		X	X

For information about accessories that are available for these terminals, see page [46](#).

PanelView Plus 6 – 700, 1000, 1250, and 1500 Terminals

This platform uses modular components with value-added options for flexible system configuration. These components are usable across the entire PanelView™ Plus 6 platform and install with minimal effort:

- Color display modules that range from 6.5 inches to 15 inches in size with either key, touch screen, or combination key/touch-screen input
- Windows CE logic modules providing desktop access
- Optional communication modules for network communication



Configured terminals with a display module and logic module can be ordered as one catalog number or as separate components for field installation. Refer to [Modular Components on page 31](#).

A high-bright display for outdoor use, plus conformal-coated and marine-certified components, extend the ability of this platform to operate in environments with even more stringent and varying requirements.

The core component of this platform is the high-performance logic module that runs a closed or open Windows CE desktop environment with optional, extended features and file viewers. System integrators and OEMs can configure and deploy systems that allow or restrict desktop access.

Terminal Features

Features	Description
High memory capacity	512 MB RAM and 512 MB nonvolatile memory (approx. 79 MB free user memory)
Power input	AC or DC
Network interface	Optional DH+™, DH-485, or ControlNet communication module
Communication ports	Ethernet, RS-232 serial
USB ports	2 USB host ports for connecting a USB mouse, keyboard, printer, and USB drives that are hot swappable 1 USB device port for connecting a host personal computer
Secure Digital (SD) card slot	Hot-swappable card slot supports 1784-SDx and SDHCx SD cards for transferring files, upgrading firmware, or logging data
Operating system	All terminals run the Windows CE 6.0 operating system (OS) which provides OS functionality that meets the needs of most users: <ul style="list-style-type: none"> • FTP server • VNC client/server • PDF reader • Active X controls • Third-party device support • FactoryTalk ViewPoint Additional functionality is available by ordering terminals with optional, extended features: <ul style="list-style-type: none"> • Internet Explorer™ web browser • Remote desktop connection • Media player • Microsoft file viewers for PowerPoint, Excel, and Word • WordPad text editor
Software	FactoryTalk® View Machine Edition Station (runtime) software, version 6.0 or later, is preloaded and activated on each terminal Single license support for FactoryTalk ViewPoint software, version 1.2 or later, gives remote users access to terminal displays via a standard web browser HMI applications are developed with FactoryTalk View Studio for Machine Edition software, which is purchased separately
Preferred controller	ControlLogix or CompactLogix

For complete technical specifications, certifications, and environmental specifications on the PanelView Plus 6 terminals, refer to the PanelView Plus 6 Specifications Technical Data, publication [2711P-TD005](#).

Terminal Selection

Model ⁽¹⁾	Input Type			Color Display Size	Input Power	Operating System
	Keypad	Touch	Keypad/Touch			
700	2711P-K7C4D8	2711P-T7C4D8	2711P-B7C4D8	7-in.	DC	Windows CE 6.0
	–	2711P-T7C4D8K ⁽²⁾	–		AC	
	2711P-K7C4A8	2711P-T7C4A8	2711P-B7C4A8		DC	Windows CE 6.0 with extended features
	2711P-K7C4D9	2711P-T7C4D9	2711P-B7C4D9		AC	
	2711P-K7C4A9	2711P-T7C4A9	2711P-B7C4A9			
1000	2711P-K10C4D8	2711P-T10C4D8	2711P-B10C4D8	10-in	DC	Windows CE 6.0
	2711P-K10C4A8	2711P-T10C4A8	2711P-B10C4A8		AC	
	2711P-K10C4D9	2711P-T10C4D9	2711P-B10C4D9		DC	Windows CE 6.0 with extended features
	2711P-K10C4A9	2711P-T10C4A9	2711P-B10C4A9		AC	
1250	2711P-K12C4D8	2711P-T12C4D8	2711P-B12C4D8	12-in	DC	Windows CE 6.0
	–	2711P-T12C4D8K ⁽²⁾	–		AC	
	2711P-K12C4A8	2711P-T12C4A8	2711P-B12C4A8		DC	Windows CE 6.0 with extended features
	2711P-K12C4D9	2711P-T12C4D9	2711P-B12C4D9		AC	
	2711P-K12C4A9	2711P-T12C4A9	2711P-B12C4A9			
1500	2711P-K15C4D8	2711P-T15C4D8	2711P-B15C4D8	15-in.	DC	Windows CE 6.0
	2711P-K15C4A8	2711P-T15C4A8	2711P-B15C4A8		AC	
	2711P-K15C4D9	2711P-T15C4D9	2711P-B15C4D9		DC	Windows CE 6.0 with extended features
	2711P-K15C4A9	2711P-T15C4A9	2711P-B15C4A9		AC	

(1) These PanelView Plus 6 terminals include Ethernet and RS-232 Communication ports, and two USB ports.

(2) This model includes conformal coating.

Modular Components

Display modules, logic modules, and communication modules can be ordered as separate components for field installation.

Display Modules

Model	Cat. No.	Input Type	Display	Marine Certified	Conformal Coated	Built-in Antiglare Overlay
700	2711P-RDK7C	Keypad	7-in. color			
	2711P-RDK7CK				X	
	2711P-RDT7C	Touch				
	2711P-RDT7CK				X	
	2711P-RDT7CM			X		
	2711P-RDB7C	Keypad/Touch				
	2711P-RDB7CK				X	
	2711P-RDB7CM			X		
1000	2711P-RDK10C	Keypad	10-in. color			
	2711P-RDT10C	Touch				
	2711P-RDT10CM			X		
	2711P-RDB10C	Keypad/Touch				
	2711P-RDB10CM			X		
1250	2711P-RDK12C	Keypad	12-in. color			
	2711P-RDK12CK				X	
	2711P-RDT12C	Touch				
	2711P-RDT12CK				X	
	2711P-RDT12AG					X
	2711P-RDT12H ⁽¹⁾	Keypad/Touch				
	2711P-RDB12C					
	2711P-RDB12CK				X	
1500	2711P-RDK15C	Keypad	15-in. color			
	2711P-RDT15C	Touch				
	2711P-RDT15AG					X
	2711P-RDB15C	Keypad/Touch				

(1) This catalog number is a high-bright display module, indicated by the H at end of cat. no., which is designed for outdoor applications. The high-bright display module can be used only with DC-powered logic modules.

Logic Modules

Extended Features	Cat. No.	Power Input	Memory RAM/Nonvolatile	Communication	Marine Certified	Conformal Coated	Included Software
No	2711P-RP8A	AC	512 MB/512 MB (approximately 79 MB free user memory)	<ul style="list-style-type: none"> Ethernet RS-232 Network interface for communication module 	x		<ul style="list-style-type: none"> Windows CE 6.0 operating system without extended features/file viewers FactoryTalk View Machine Edition Station (runtime), version 6.0 or later FactoryTalk ViewPoint software, version 1.2 or later
	2711P-RP8D	DC			x		
	2711P-RP8DK				x	x	
Yes	2711P-RP9A	AC	512 MB/512 MB (approximately 79 MB free user memory)	<ul style="list-style-type: none"> Ethernet RS-232 Network interface communication module 	x		<ul style="list-style-type: none"> Windows CE 6.0 operating system with extended features/file viewers FactoryTalk View Machine Edition Station (runtime), version 6.0 or later FactoryTalk ViewPoint software, version 1.2 or later
	2711P-RP9D	DC			x		
	2711P-RP9DK				x	x	

Communication Modules

Cat. No.	Communication				Conformal Coated	Marine Certified
	Ethernet	DH+	DH-485	ControlNet ⁽²⁾		
2711P-RN6		x	x			
2711P-RN6K		x	x		x	
2711P-RN15S				x		x
2711P-RN15SK				x	x	
2711P-RN20 ⁽¹⁾	x					

(1) All terminals have an Ethernet port. The cat. no. 2711P-RN20 module provides an additional Ethernet port.

(2) Scheduled and unscheduled communication.

For information about accessories that are available for these terminals, see page [47](#).

PanelView Plus 6 – 400 and 600 Terminals

The smaller PanelView™ Plus 6 - 400 and 600 terminals combine the display, logic, memory, and power into one base unit:

- The 400 model has a 3.5-in. color graphic display with keypad or combination key and touch input, or a grayscale display with keypad input.
- The 600 model has a 5.7-in. color or grayscale graphic display with keypad, touch screen, or combination keypad/touch-screen input.



This new generation of terminals runs the Windows CE 6.0 operating system similar to the PanelView Plus 6 - 700...1500 terminals. The terminals run HMI applications but also allow access to the desktop. For users with more complex application requirements, the 600 color terminals can be ordered with optional, extended features and file viewers.

Terminal Features

Features	Description
High memory capacity	256 MB RAM and 512 MB nonvolatile memory (approximately 73 MB free user memory)
Power input	AC or DC
Communication ports	Units are available with one of these communication options: <ul style="list-style-type: none"> • RS-232 • Ethernet and RS-232 Separate communication modules are not supported.
USB ports	<ul style="list-style-type: none"> • 1 USB host ports for connecting a USB mouse, keyboard, printer, and USB drives that are hot swappable • 1 USB device port for connecting a host personal computer
Secure Digital (SD) card slot	Hot-swappable card slot supports 1784-SDx SD cards for transferring files, upgrading firmware, or logging data
Operating system	All terminals run the Windows CE 6.0 operating system (OS) which provides OS functionality that meets the needs of most users: <ul style="list-style-type: none"> • FTP server • VNC client/server • PDF reader • FactoryTalk Viewpoint • Active X controls • Third-party device support Additional functionality is available for the 600 terminals by ordering terminals with these optional, extended features: <ul style="list-style-type: none"> • Internet Explorer™ web browser • Media player • Microsoft file viewers for PowerPoint, Excel, and Word • WordPad text editor
Software	<ul style="list-style-type: none"> • FactoryTalk® View Machine Edition Station (runtime) software, version 6.10 or later, is preloaded and activated on each terminal • HMI applications are developed with FactoryTalk View Studio for Machine Edition software, which is purchased separately
Reset and default switches	Provide easy access to diagnostic and repair operations
Preferred controller	CompactLogix™ or ControlLogix®

For complete technical specifications, certifications, and environmental specifications on the PanelView Plus 6 terminals, refer to the PanelView Plus 6 Specifications Technical Data, publication [2711P-TD005](#).

Terminal Selection

Model ⁽¹⁾	Input Type			Display Size	Communication		Input Power	Operating System
	Keypad	Touch	Keypad/Touch		RS-232	Ethernet		
400	2711P-K4M5A8	—	—	4-in. Grayscale	x		AC	Windows CE 6.0
	2711P-K4M5D8	—	—		x		DC	
	2711P-K4M20A8	—	—		x	x	AC	
	2711P-K4M20D8	—	—		x	x	DC	
	2711P-K4C5A8	—	2711P-B4C5A8	4-in. Color	x		AC	
	2711P-K4C5D8	—	2711P-B4C5D8		x		DC	
	2711P-K4C20A8	—	2711P-B4C20A8		x	x	AC	
	2711P-K4C20D8	—	2711P-B4C20D8		x	x	DC	
600	2711P-K6M5A8	2711P-T6M5A8	2711P-B6M5A8	6-in. Grayscale	x		AC	
	2711P-K6M5D8	2711P-T6M5D8	2711P-B6M5D8		x		DC	
	2711P-K6M20A8	2711P-T6M20A8	2711P-B6M20A8		x	x	AC	
	2711P-K6M20D8	2711P-T6M20D8	2711P-B6M20D8		x	x	DC	
	2711P-K6C5A8	2711P-T6C5A8	2711P-B6C5A8	6-in. Color TFT	x		AC	
	2711P-K6C5D8	2711P-T6C5D8	2711P-B6C5D8		x		DC	
	2711P-K6C20A8	2711P-T6C20A8	2711P-B6C20A8		x	x	AC	
	2711P-K6C20D8	2711P-T6C20D8	2711P-B6C20D8		x	x	DC	
	2711P-K6C5A9	2711P-T6C5A9	2711P-B6C5A9		x		AC	
	2711P-K6C5D9	2711P-T6C5D9	2711P-B6C5D9		x		DC	
	2711P-K6C20A9	2711P-T6C20A9	2711P-B6C20A9		x	x	AC	
	2711P-K6C20D9	2711P-T6C20D9	2711P-B6C20D9		x	x	DC	

(1) These PanelView™ Plus 6 terminals include one USB port.

For information about accessories available for these terminals, see page [47](#).

PanelView Plus 6 – Compact Terminals

The next generation PanelView™ Plus 6 Compact 400, 600, and 1000 terminals offer just the right hardware and software functionality to meet the needs of mid-size applications. Any application that is created for a compact terminal is also compatible with other PanelView Plus 6 terminals. Key features include the following:



- 25 displays and 200 alarm messages supported in the FactoryTalk® View Compact Machine Edition application
- Fixed hardware configurations without the addition or replacement of modular components

Terminal Features

Features	Description
High memory capacity	256 MB RAM and 512 MB nonvolatile memory (approximately 73 MB free user memory) ⁽¹⁾
Power input	DC
Communication ports	RS-232 serial and Ethernet
USB ports	1 USB device port for connecting a host personal computer
Secure Digital (SD) card slot	Hot-swappable card slot supports 1784-SDx SD cards for transferring files, upgrading firmware, or logging data
Operating system	All terminals run the Windows CE 6.0 operating system (OS) providing OS functionality needed for most users needs: <ul style="list-style-type: none"> • FTP server • VNC client/server • PDF reader • FactoryTalk Viewpoint • Active X controls • Third-party device support
Software	<ul style="list-style-type: none"> • FactoryTalk® View Machine Edition Station (runtime) software, version 6.10 or later, is preloaded and activated on each terminal • Single license support for FactoryTalk ViewPoint software, version 1.2 or later, gives remote users access to a terminal display via standard web browser • HMI applications are developed with FactoryTalk View Studio for Machine Edition software, which is purchased separately • Connection to single controller by using either RSLinx® Enterprise software, version 5.51 or later, or KEPServer software
Preferred controller	CompactLogix™

(1) The 10.4-in. terminal comes with 512 MB RAM and 512 MB nonvolatile memory (approximately 79 MB free user memory).

For complete technical specifications, certifications, and environmental specifications on the PanelView Plus 6 terminals, refer to the PanelView Plus 6 Specifications Technical Data, publication [2711P-TD005](#).

Terminal Selection

Model	Input Type			Display	
	Keypad	Touch	Keypad/Touch	Size	Type
400	2711PC-K4M20D8	—	—	4-in.	Grayscale
	—	—	2711PC-B4C20D8		Color
	—	—	2711PC-B4C20D8-LR		Low Reflective
600	—	2711PC-T6M20D8	—	6-in.	Grayscale
	—	2711PC-T6C20D8	—		Color
1000	—	2711PC-T10C4D8	—	10-in.	

For information about accessories that are available for these terminals, see page [50](#).

Notes:

MobileView Tethered Operator Terminals

The MobileView™ 2711T family of human machine interface (HMI) devices have a rugged design with Microsoft® Windows® 7 Embedded Standard. The MobileView 2711T terminal features include a 3-position enable switch, touch and function keys, and stop push buttons. These features allow operator access to the safety system of the machine and the general interface to its control system.



The MobileView 2711T terminal is ideal for various applications, including:

- Operator panel for machines and plants
- Teach and programming panel for robots
- Test, maintenance, and startup

The MobileView 2711T terminal easily adapts to specific applications by using configurable operating and control elements. A cable and junction box are required for the operation of a MobileView terminal.

Terminal Features

Features	Description
Display size	10 in.
Enabling Switch	Yes
High memory capacity	4 GB RAM/32 GB SSD
Power input	DC
Communication ports	10/100 Ethernet
USB ports	One USB host port
Secure Digital (SD) card slot	Internal SD card
Operating system	All terminals run the Windows® 7 Embedded Standard operating system (OS).
Software	FactoryTalk® View Studio for Machine Edition
Preferred controller	ControlLogix®

For complete technical specifications, certifications, and environmental specifications on the MobileView tethered operator terminals, refer to the MobileView Tethered Operator Terminals and Junction Boxes Technical Data, publication [2711T-ID001](#).

Terminal Selection – First Generation MobileView Terminals

Cat. No.	Display Size (in.)	Touch Screen	Function Keys	3-position Enabling Switch	3-position Key Switch	Momentary Button	2-circuit Push Button	
							E-stop (red/yellow)	Stop (gray)
2711T-B10R1K1	10.1	Yes	Yes	Yes	No	No	Yes	No
2711T-B10R1M1								
2711T-F10G1N1								
2711T-T10G1N1								
2711T-T10R1N1								

Terminal Selection – Second Generation MobileView Terminals

Cat. No.	Display Size (in.)	Touch Screen	Function Keys	3-position Enabling Switch	3-position Key Switch	Momentary Button	2-circuit Push Button	
							Illuminated E-stop (red/yellow)	Stop (gray)
2711T-B10I1N1	10.1	Yes	Yes	Yes	No	No	Yes	No
2711T-T10I1N1-TC			No					

For information about accessories that are available for these terminals, see page [52](#).

Notes:

PanelView 800 Terminals

When you need an essential component but with a reduced cost, look to the PanelView™ 800 family of operator interface devices. The PanelView 800 platform features a full line of 4-inch, 7-inch, and 10-inch displays (PanelView Component terminals maintain their 2-inch and 3-inch displays). Preferred integration with Allen-Bradley® MicroLogix™, Micro800®, CompactLogix™ 5370, and SLC™ 500 families of logic controllers offers a control and visualization solution for various applications. The PanelView 800 platform includes the Connected Components Workbench™ software as the common programming software.



Other key features include the ability to do the following:

- Secure information on screens with user name and password protection.
- Remote monitoring with Virtual Network Computing (VNC) server.
- Display information in languages including Chinese, Portuguese, French, Italian, German, Spanish, and Korean.
- Alert operators with alarm messages that include embedded variables and an alarm status/history.
- Upload and download groups of data or parameter settings within the recipe feature.
- Use Connected Components Workbench software, the integrated design and configuration software that offers HMI programming and controller programming within the same common platform.

Terminal Features

Features	Description
High memory capacity	256 MB RAM and 256 MB storage
Power input	24V DC
Communication ports	Serial ⁽¹⁾ and Ethernet
USB ports	One USB high-speed 2.0 host port
Software	Connected Components Workbench with DesignStation
Preferred controller	MicroLogix, Micro800, and CompactLogix 5370 controllers ⁽²⁾

(1) Serial refers to RS-232 (DF1), RS-232 (DH-485), RS-485 communication.

(2) CompactLogix 5370, excluding L37 and L38.

For complete technical specifications, certifications, and environmental specifications on the PanelView 800 terminals, refer to the PanelView 800 Terminals Technical Data, publication [2711R-TD001](#).

For complete technical specifications, certifications, and environmental specifications on the PanelView Component terminals, refer to the PanelView Component Specifications Technical Data, publication [2711C-TD001](#).

Terminal Selection

Model	Cat. No.	Display		Input Type
		Size	Type	
PanelView 800	2711R-T4T	4 in.	Color transmissive TFT	Analog touch and function keys
	2711R-T7T	7 in.		Analog touch
	2711R-T10T	10 in.		
PanelView Component C200	2711C-F2M	2-in.	Monochrome transfective STN	Four function keys
	2711C-K2M			Ten function keys and numeric keypad
PanelView Component C300	2711C-T3M	3-in.		Touch screen
	2711C-K3M			Ten function keys and numeric keypad

For information about accessories that are available for these terminals, see page [53](#).

PanelView Terminal Accessories

The tables in this chapter list accessories and communication cables available for PanelView™ terminals.

PanelView 5000 Accessories

The following tables list accessories for PanelView 5000 terminals. For information about keyboards and pointing devices that are compatible with the PanelView 5000 terminals, see page [83](#).

Protective Overlays

Cat. No.	PanelView 5000 Terminal Model	Input	Display	Quantity
2711P-RGT7SP ⁽¹⁾	7 in.	Touch	—	3
2711P-RGB7P		Touch with key-pad		
2711P-RGT7W		Touch	Wide	
2711P-RGT9SP ⁽¹⁾	9 in.	Touch	—	
2711P-RGT10SP ⁽¹⁾	10 in.			
2711P-RGB10P		12 in.	Touch	
2711P-RGT12SP ⁽¹⁾	15 in.			
2711P-RGT15SP				
2711P-RGB15P				
2711P-RGT19P	19 in.	Touch	—	

(1) Although this protective overlay was designed for the PanelView 5510 terminal, it can also be used for the corresponding size PanelView 5310 terminal. Cat. No. 2711P-RGT6S can be used for the 6-in. PanelView 5310 terminal. When these overlays are used on a PanelView 5310 terminal, there is an increased air gap between the overlay and the terminal screen.

Power Supplies and Power Terminal Blocks

Cat. No.	Description	Quantity
1606-XLP95E	DIN-rail power supply, 24...28V DC output voltage, 95 W	1
1606-XLP100E	DIN-rail power supply, 24...28V DC output voltage, 100 W	
2711P-RSACDIN	DIN-rail power supply, AC-to-DC, 85...265V AC, 47...63 Hz	
2711P-RTBDSP	3-pin DC power terminal block	10

USB Programming Cable

Cat. No.	Description	Length
6189V-USBCBL2	Programming cable that connects the device port of the terminal to a USB host port of a computer	1.8 m (5.9 ft)

Mounting Hardware

Cat. No.	Description	Quantity
2711P-RMCP	Mounting levers	16

Battery Replacement

Cat. No.	Description	Quantity
2711P-RY2032	Lithium coin cell battery, CR2032 equivalent	1

Secure Digital (SD) Cards⁽¹⁾

Cat. No.	Description
1784-SD1	1 GB SD card
1784-SD2	2 GB SD card
1784-SDHC8	8 GB SDHC card
1784-SDHC32	32 GB SDHC card
2711C-RCSA	USB to SD adapter for SD card

(1) To help reduce the chance of corruption when you use SD Cards or USB drives with the terminal, Rockwell Automation recommends that you use only the above SD card catalog numbers.

The SD™ and SDHC™ accessory cards in the above table have been designed to meet industrial robustness and environmental requirements. Rockwell Automation recommends that you use these accessory cards with the terminal to help reduce the chances of corruption. Studio 5000 View Designer software requires the following for SD cards that are inserted into the HMI device:

- 4 GB of free space
- A supported SDHC card type, preferably one listed in the [Secure Digital \(SD\) Cards](#) table
- An environmental rating for the PanelView 5000 environment
- A supported format of either FAT32 or ext3

ArmorView Plus 7 Accessories

The following tables list accessories for ArmorView Plus 7 terminals.

Mounting Hardware

Cat. No.	Description	Quantity
2711P-RVESA01	VESA kit (VESA access cover and I/O plate)	1

Handle

Cat. No.	Description	Quantity
2711P-RHNDL01 ⁽¹⁾	Handle (83.1 x 345 x 50.7 (3.27 x 13.58 x 2.0))	1

(1) Operators can install one, two, or three handles to the ArmorView Plus 7 terminal. Indentations for installing the handle are located opposite the arm mount adapter (or the I/O plate), and on both sides. To install more than one handle, order multiple handle kits.

Stack Light

Cat. No.	Description	Quantity
854J-BVMC (vertical mount) ⁽¹⁾	40 mm (1.57 in.) control tower stack light, black base, vertical mount, cap included	1

(1) The stack light can be installed on the right, left, or both sides of the ArmorView Plus 7 terminal. If it is attached on the left side, it faces upward, and if it is attached on the right side, it faces downward. To install more than one stack light, order multiple stack lights.

Cables

Cat. No.	Description	Quantity
2711P-RIOIN3M	Input point cable for customer-installed switch (3-pin male Pico™ style connector for Ethernet I/O module)	1
2711P-RIOUT3M	Output point cable for customer-installed indicator light (3-pin male Pico style connector for Ethernet I/O module)	1

PanelView Plus 7 Accessories – Performance Terminals

The following tables list accessories for PanelView Plus 7 Performance terminals. For information about keyboards and pointing devices that are compatible with the PanelView Plus 7 Performance terminals, see page [83](#).

Protective Overlays

Cat. No.	PanelView Plus 7 Terminal Model	Input	Quantity
2711P-RGT7SP	7 in.	Touch	3
2711P-RGB7P		Touch with keypad	
2711P-RGT9SP	9 in. (wide)	Touch	
2711P-RGT10SP	10 in.	Touch	
2711P-RGB10P		Touch with keypad	
2711P-RGT12SP	12 in. (wide)	Touch	
2711P-RGT15SP	15 in.	Touch	
2711P-RGB15P		Touch with keypad	
2711P-RGT19P	19 in.	Touch	

Mounting Hardware

Cat. No.	Description	Quantity
2711P-RMCP ⁽¹⁾	Mounting levers	16
2711P-RTMC ⁽²⁾	Mounting clips	8

(1) These levers are also used with the PanelView 5510 terminals.

(2) Catalog number 2711P-RTMC mounting clips are used for stainless steel terminals, catalog numbers 2711P-T9W22D9P-BSHK, or 2711P-T12W22D9P-BSHK. Catalog number 2711P-T12W22D9P-BSHK requires 10 mounting clips. If you need more than eight clips, order two 2711P-RTMC mounting clip kits.

Battery Replacement

Cat. No.	Description	Quantity
2711P-RY2032	Lithium coin cell battery, CR2032 equivalent	1

Battery Cover

Cat. No.	Description	Quantity
2711P-RYKS	Replacement cover for the battery compartment.	3

Cables

Cat. No.	Description	Quantity
9300-USBCBL-CP3	USB-A, 9 pin D-sub connector, serial, 2 m (6.56 ft)	1
9300-USBCBL-PM02	USB-A, 8-pin MicroLogix, serial, 2 m (6.56 ft)	1

Secure Digital (SD) Cards⁽¹⁾

Cat. No.	Description	Quantity
1784-SD1	1 GB SD card	1
1784-SD2	2 GB SD card	
1784-SDHC8	8 GB SDHC card	
1784-SDHC32	32 GB SDHC card	
2711C-RCSD	USB to SD adapter for SD card	

(1) To help reduce the chance of corruption when you use SD Cards or USB drives with the terminal, Rockwell Automation recommends that you use only the above SD card catalog numbers.

Power Supplies

Cat. No.	Description	Quantity
1606-XLP95E	DIN-rail power supply, 24 . . . 28V DC output voltage, 95 W	1
1606-XLP100E	DIN-rail power supply, 24 . . . 28V DC output voltage, 100 W	
2711P-RSACDIN	DIN-rail power supply, AC-to-DC, 85 . . . 265V AC, 47 . . . 63 Hz	

Terminal Blocks

Cat. No.	Description	Quantity
2711P-RTBAP	3-pin AC power terminal block	10
2711P-RTBDSP	3-pin DC power terminal block	

IMPORTANT Before you select the appropriate replacement gasket, you must identify the series of the PanelView Plus 7 Performance Stainless Steel terminal. The terminal's series information is located on the terminal's product nameplate label. In the following table, gaskets that are listed for use on Series B terminals are not certified for use on Series A terminals, and gaskets that are listed for use on Series A terminals are not certified for use on Series B terminals.

Gaskets

Cat. No.	Description	Terminal Series	Quantity
2711P-RGST9W	Hygienic gasket, blue silicone For 9-in. Series A Stainless Steel Terminals	A	1
2711P-RGST12W	Hygienic gasket, blue silicone For 12-in. Series A Stainless Steel Terminals	A	1
2711P-RGST9WB	Hygienic gasket, blue, silicone, with ribs For 9-in. Series B Stainless Steel Terminals	B	1
2711P-RGST9WB	Hygienic gasket, blue, silicone, with ribs For 12-in. Series B Stainless Steel Terminals	B	1

PanelView Plus 7 Accessories – Standard Terminals

The following tables list accessories for PanelView Plus 7 standard 4, 6, 7, 9, 10, 12, and 15-inch terminals. Display modules, logic modules, and communication modules can be ordered as separate components for field installation. For information about keyboards and pointing devices that are compatible with the PanelView Plus 7 standard terminals, see page [83](#).

Protective Overlays

Cat. No.	PanelView Plus 7 Terminal Model	Input	Quantity
2711P-RGT4S	4 in. (Wide)	Touch	3
2711P-RGT6S	5 in.		
2711P-RGB7SP	6 in.		
2711P-RGT9SP	9 in. (Wide)		
2711P-RGT10SP	10 in.		
2711P-RGT12SP	12 in. (Wide)		
2711P-RGT15SP	15 in.		

Mounting Hardware

Cat. No.	Description	Quantity
2711P-RMCS	Mounting levers	12

Battery Replacement

Cat. No.	Description	Quantity
2711P-RY2032	Replacement battery CR2032 coin-cell equivalent battery	1

Battery Cover

Cat. No.	Description	Quantity
2711P-RYKS	Replacement cover for the battery compartment.	3

Cables

Cat. No.	Description	Quantity
9300-USBCBL-CP3	USB-A, 9 pin D-sub connector, serial, 2 m (6.56 ft)	1
9300-USBCBL-PM02	USB-A, 8-pin MicroLogix, serial, 2 m (6.56 ft)	1

Secure Digital (SD) Cards⁽¹⁾

Cat. No.	Description	Quantity
1784-SD1	1 GB SD card	1
1784-SD2	2 GB SD card	1
1784-SDHC8	8 GB SDHC card	1
1784-SDHC32	32 GB SDHC card	1
2711C-RCSD	USB to SD adapter for SD card	1

(1) To help reduce the chance of corruption when you use SD Cards or USB drives with the terminal, Rockwell Automation recommends that you use only the above SD card catalog numbers.

SD Cover

Cat. No.	Description	Quantity
2711P-RCKS	Replacement cover for the SD compartment.	3

Power Supplies

Cat. No.	Description
1606-XLP95E	DIN-rail power supply, 24 . . . 28V DC output voltage, 95 W
1606-XLP100E	DIN-rail power supply, 24 . . . 28V DC output voltage, 100 W
2711P-RSACDIN	DIN-rail power supply, AC-to-DC, 85 . . . 265V AC, 47 . . . 63 Hz

Terminal Blocks

Cat. No.	Description	Quantity
2711P-RTBAP	DC power terminal block	10

PanelView Plus 6 Accessories

The following tables list accessories for PanelView Plus 6 – 400, 600, 700, 1000, 1250, and 1500 terminals. For information about keyboards and pointing devices that are compatible with the PanelView Plus 6 terminals, see page [83](#).

Programming Cables

Cat. No.	Terminal Model	Description	Length
6189V-USBCBL2	400, 600	Programming cable that connects the USB device port of the terminal to a USB host port of a computer	1.8 m (6 ft)
2711C-CBL-UU02	700, 1000, 1250, 1500		2 m (6.5 ft)

Function Key Legend Inserts

Cat. No.	Terminal Model ⁽¹⁾	Description
2711P-RFK6	600 keypad and keypad/ touch	Blank legend inserts and software
2711P-RFK7	700 keypad	
2711P-RFK10	1000 keypad	
2711P-RFK12	1250 keypad	
2711P-RFK15	1500 keypad	

(1) Applies to keypad and keypad/touch-screen terminals.

Secure Digital (SD) Cards⁽¹⁾

Cat. No.	Terminal Model	Description	Quantity
1784-SD1	400, 600, 700, 1000, 1250, 1500	1 GB SD card	1
1784-SD2		2 GB SD card	1
1784-SDHC8	700, 1000, 1250, 1500	8 GB SDHC card	1
1784-SDHC32		32 GB SDHC card	1

(1) To help reduce the chance of corruption when you use SD Cards or USB drives with the terminal, Rockwell Automation recommends that you use only the above SD card catalog numbers.

Antiglare Overlays

Cat. No. ⁽¹⁾	Terminal Model	Type
2711P-RGB4	400 grayscale or color	Keypad, Key/Touch
2711P-RGK6	600 grayscale or color	
2711P-RGT6		Touch
2711P-RGK7	700	Keypad, Key/Touch
2711P-RGT7		Touch
2711P-RGK10	1000	Keypad, Key/Touch
2711P-RGT10		Touch
2711P-RGK12	1250	Keypad, Key/Touch
2711P-RGT12		Touch
2711P-RGK15	1500	Keypad, Key/Touch
2711P-RGT15		Touch

(1) Three overlays are shipped with each catalog number.

Mounting Hardware

Cat. No.	Terminal Model	Description	Quantity
2711P-RTFC	400, 600	Mounting levers	8
2711P-RTMC	700, 1000, 1250, 1500	Mounting clips	

Battery Replacement

Cat. No.	Terminal Model	Description	Quantity
2711P-RY2032	400, 600, 700, 1000, 1250, 1500	Replacement battery CR2032 coin-cell equivalent battery	1

Power Supply and Power Terminal Blocks

Cat. No.	Terminal Model	Description	Quantity
1606-XLE120E	400, 600, 700, 1000, 1250, 1500	DIN-rail power supply, AC-to-DC, 85 . . . 265V AC, 47 . . . 63 Hz	1
2711P-6RSA	400, 600	AC power module converts a DC-powered terminal to AC power	
2711P-RVAC		AC power terminal block	10
2711P-TBDC		DC power terminal block	
2711P-RTBAC3	700, 1000, 1250, 1500	AC power terminal block	
2711P-RTBDC2		2-pin DC power terminal block	

Solar Visor

Cat. No.	Terminal Model	Description
2711P-RVT12	1250	Solar visor for 1250 high-bright display module, cat. no. 2711P-RDT12H

Backlight Replacements

Cat. No.	Terminal Model	Series	Number of Backlights
2711P-RL7C	700	A and B	1
2711P-RL7C2		C and D	
2711P-RL10C2	1000	B and C	
2711P-RL12C	1250	A and B	2
2711P-RL12C2		C	1
2711P-RL15C	1500	B	2

Bezel Replacements

Cat. No.	Terminal Model	Type
2711P-RBK7	700	Keypad
2711P-RBT7		Touch
2711P-RBB7		Key/Touch
2711P-RBK10	1000	Keypad
2711P-RBT10		Touch
2711P-RBB10		Key/Touch
2711P-RBK12	1250	Keypad
2711P-RBT12		Touch
2711P-RBT12H ⁽¹⁾		
2711P-RBB12		Key/Touch
2711P-RBK15	1500	Keypad
2711P-RBT15		Touch
2711P-RBB15		Key/Touch

(1) Applies to the cat. no. 2711P-RDT12H 1250 high-bright display module.

PlusView Plus 6 Compact Accessories

The tables list accessories for PanelView Plus 6 Compact terminals.

Secure Digital (SD) Cards⁽¹⁾

Cat. No.	Description
1784-SD1	1 GB SD card
1784-SD2	2 GB SD card
1784-SDHC8	8 GB SDHC card
1784-SDHC32	32 GB SDHC card
2711C-RCSD	USB to SD adapter for SD card

(1) To help reduce the chance of corruption when you use SD Cards or USB drives with the terminal, Rockwell Automation recommends that you use only the above SD card catalog numbers.

Antiglare Overlays

Cat. No. ⁽¹⁾	Terminal Model	Input Type		
		Keypad	Touch	Key/Touch
2711P-RGB4	400 grayscale or color	x		x
2711P-RGT6	600 grayscale or color		x	
2711P-RGT10	1000 color		x	

(1) Three overlays are shipped with each catalog number.

Mounting Hardware

Cat. No.	Description	Quantity
2711P-RTFC	Mounting levers (600 only)	8
2711P-RTMC	Mounting levers for (1000 only)	

Power Supply and Power Terminal Blocks

Cat. No.	Description	Quantity
1606-XLE120E	DIN-rail power supply, AC-to-DC, 85...265V AC, 47...63 Hz	1
2711P-6RSA	AC power module converts a DC-powered terminal to AC power (400 and 600 only)	
2711P-TBDC	DC power terminal block (400 and 600 only)	10
2711P-RTBDC2	2-pin DC power terminal block (1000 only)	

Cables

Cat. No.	Description	Length
6189V-USBCBL2	Programming cable that connects the USB device port of the terminal to a USB host port of a computer (400 and 600 only)	1.8 m (6 ft)
2711C-CBL-UU02	Programming cable that connects the USB device port of the terminal to a USB host port of a computer (1000 only)	2 m (6.5 ft)

Battery Replacement

Cat. No.	Description	Quantity
2711P-RY2032	Replacement battery CR2032 coin-cell equivalent battery	1

MobileView Tethered Operator Terminal Accessories

The tables list accessories for the 2711T tethered operator terminals.

For First Generation MobileView Terminals (cat. nos. 2711T-B10R1K1, -B10R1M1, -F10G1N1, -T10G1N1, and -T10R1N1)

Cat. No.	Description
2711T-5MCABLE	Connection cable 5 m (16.4 ft) with silver connector to connect a 20-pin MobileView™ terminal to an IP20 junction box.
2711T-10MCABLE	Connection cable 10 m (32.8 ft) with silver connector to connect a 20-pin MobileView terminal to an IP20 junction box.
2711T-15MCABLE	Connection cable 15 m (49.2 ft) with silver connector to connect a 20-pin MobileView terminal to an IP20 junction box.
2711T-JBIP20DC	A 24V DC powered, IP20 junction box that includes a junction box cap.
2711T-JUMP	A silver, 20-pin bridge connector to bypass emergency stop (E-stop) contactors in an IP20 MobileView junction box. ⁽¹⁾

(1) For applications where the customer plans to move one MobileView terminal between many MobileView junction boxes.

For Second Generation MobileView Terminals (cat. nos. 2711T-B10I1N1 and -T10I1N1-TC)

Cat. No.	Description
2711T-5MCABLE2	Connection cable 5 m (16.4 ft) with black connector to connect a 22-pin MobileView terminal to an IP65 junction box.
2711T-10MCABLE2	Connection cable 10 m (32.8 ft) with black connector to connect a 22-pin MobileView terminal to an IP65 junction box.
2711T-15MCABLE2	Connection cable 15 m (49.2 ft) with black connector to connect a 22-pin MobileView terminal to an IP65 junction box.
2711T-JBIP65DC1 ⁽¹⁾	A 24V DC powered, IP65 junction box with cord grips, and Box ID and E-stop bypass functionality.
2711T-JBIP65DM1 ⁽¹⁾	A 24V DC powered, IP65 junction box with M12 on-machine connectors, and Box ID and E-stop bypass functionality.
2711T-JBBKCOVER	A back cover accessory plate for the 2711T-JBIP65DC1 and 2711T-JBIP65DM1 junction boxes.
2711T-22JUMP	A black, 22-pin bridge connector to bypass emergency stop (E-stop) contactors in an IP65 MobileView junction box. ⁽²⁾

(1) First generation MobileView terminals 2711T-T10G1N1 and 2711T-F10G1N1 can be used with IP65 junction boxes and 22-pin connection cables.

(2) For applications where the customer plans to move one MobileView terminal between many MobileView junction boxes.

For All MobileView Terminals

Cat. No.	Description
2711T-BRACKET	Mounting bracket for stationary operation or to store the terminal.
2711T-VMBRACKET	VESA Mounting bracket for stationary operation, to store the terminal, or to lock the terminal for security reasons.

PanelView 800 Terminal Accessories

The tables list accessories for PanelView 800 and PanelView Component terminals.

Antiglare Overlays

Cat. No. ⁽¹⁾	PanelView Component Model	Input Type		
		Function Key	Numeric Keypad	Touch
2711C-RG2F	C200	x		
	C300			x
2711C-RG2K	C200		x	
	C300		x	
2711C-RG6T ⁽²⁾	C600			x
2711C-RG10T ⁽²⁾	C1000			x

(1) Three overlays are shipped with each catalog number.

(2) This product is scheduled to reach end-of-life (EOL) status in December 2017.

Power Terminal Blocks

Cat. No.	Description	Quantity
2711C-RJ422	RS-422/RS-485 connector with resistor ⁽¹⁾	10
2711R-TBDC	DC power terminal block	

(1) This power terminal block is also used with PanelView 800 terminals.

Power Supply

Cat. No.	Description	Quantity
2711P-RSACDIN	DIN-rail mount AC-to-DC power supply, 85...265V AC, 47...63 Hz ⁽¹⁾	1

(1) This power supply is also used with PanelView 800 terminals.

Adapter Plate Kit

Cat. No.	Description	Quantity
2711R-APK7	PanelView 800 Adapter Plate Kit for 7-Inch Terminal	1
2711R-APK10	PanelView 800 Adapter Plate Kit for 10-Inch Terminal	

PanelView Terminal Communication Cables

The following tables list communication cables available for the PanelView family of terminals.

PanelView Plus 7 Terminals

The following tables list runtime communication cables for PanelView Plus 7 Standard (400W, 600, 700, 900W, 1000, 1200W, 1500) and PanelView Plus 7 Performance (700, 900W, 1000, 1200W, 1500, and 1900) terminals.

All PanelView Plus 7 terminals use a standard Ethernet 1585J-M type or 2711P-CBL-EX04 (4m/14 ft) cable for application transfers between a computer and the terminal and between the terminal and the Ethernet connection of the controller. There are two optional cables to use when serial communication is a must: 9300-USBCBL-CP3 and 9300-USBCBL-PMO2 for USB-to-serial connections.

Communication Cables: PanelView Plus 7 Terminals to PLC-5® Controllers

	PLC-5®E
PanelView Plus 7 Standard (400W, 600, 700, 900W, 1000, 1200W, 1500)	Port: CH2 Ethernet RJ45 Protocol: EtherNet/IP
PanelView Plus 7 Performance (700, 900W, 1000, 1200W, 1500, and 1900)	1585J-M type cable or 2711P-CBL-EX04 (4 m/14 ft)

Communication Cables: PanelView Plus 7 Terminals to SLC Controllers

	SLC™ 5/05
PanelView Plus 7 Standard (400W, 600, 700, 900W, 1000, 1200W, 1500))	Port: CH1 - Ethernet - RJ45 Protocol: EtherNet/IP
PanelView Plus 7 Performance (700, 900W, 1000, 1200W, 1500, and 1900)	1585J-M type cable or 2711P-CBL-EX04 (4 m/14 ft) 9300-USBCBL-CP3 cable for USB-to-serial communication

Communication Cables: PanelView Plus 7 Terminals to MicroLogix Controllers

	MicroLogix™ 1100, 1400
PanelView Plus 7 Standard (400W, 600, 700, 900W, 1000, 1200W, 1500)	Port: Ethernet - RJ45 Protocol: EtherNet/IP
PanelView Plus 7 Performance (700, 900W, 1000, 1200W, 1500, and 1900)	1585J-M type cable or 2711P-CBL-EX04 (4 m/14 ft) 9300-USBCBL-PMO2 for USB-to-serial communication

Communication Cables: PanelView Plus 7 Terminals to CompactLogix Controllers

	CompactLogix™ L35E, L23E, L32E, 1768-ENBT, and 5370 L1, L2, L3
PanelView Plus 7 Standard (400W, 600, 700, 900W, 1000, 1200W, 1500)	Port: Ethernet - RJ45 Protocol: EtherNet/IP
PanelView Plus 7 Performance (700, 900W, 1000, 1200W, 1500, and 1900)	1585J-M type cable or 2711P-CBL-EX04 (4 m/14 ft) 9300-USBCBL-CP3 cable for USB-to-serial communication

Communication Cables: PanelView Plus 7 Terminals to ControlLogix Controllers

	ControlLogix®
PanelView Plus 7 Standard (400W, 600, 700, 900W, 1000, 1200W, 1500)	Communication Module: 1756-ENBT, 1756-ENxT Protocol: EtherNet/IP
PanelView Plus 7 Performance (700, 900W, 1000, 1200W, 1500, and 1900)	1585J-M type cable or 2711P-CBL-EX04 (4 m/14 ft) 9300-USBCBL-CP3 cable for USB-to-serial communication

PanelView Plus 6 Terminals

The following tables list runtime communication cables for PanelView Plus 6 (400, 600, 700, 1000, 1250, 1500) terminals. PanelView Plus 6 Compact terminals use the same cables as PanelView Plus 6 (400 and 600) terminals.

All PanelView Plus 6 terminals use a standard Ethernet 1585J-M type or 2711P-CBL-EX04 (4m/14 ft) cable for application transfers between a computer and the terminal.

Communication Cables: PanelView Plus 6 Terminals to PLC-5 Controllers

	PLC-5, PLC-5C, PLC-5E	PLC-5, PLC-5C, PLC-5E	PLC-5E	PLC-5C
	Port: CH0 - 25-pin RS-232 Protocol: DF1	Port: CH1/CH2 DH+™ Protocol: DH+™	Port: CH2 Ethernet RJ45 Protocol: EtherNet/IP	Port: ControlNet Port Protocol: ControlNet
PanelView Plus 6 Compact 400, 600, 1000	2711-NC13 (5 m/16 ft) or 2711-NC14 (10 m/32 ft) cable (Requires DB9 to DB25 adapter)	—	1585J-M type cable or 2711P-CBL-EX04 (4 m/14 ft)	—
PanelView Plus 6 400, 600		—		—
PanelView Plus 6 700, 1000, 1250, 1500		Requires 2711P-RN6 or 2711P-RN6K module, with shielded twinaxial cable (1770-CD)		Requires 2711P-RN155 or 2711P-RN155K module, and 1786 ControlNet media

Communication Cables: PanelView Plus 6 Terminals to SLC Controllers

	SLC 5/01, 5/02, 5/03	SLC 5/03, 5/04, 5/05	SLC 5/04	SLC 5/05
	Port: CH1 - RJ45 Protocol: DH-485	Port: CH0 - 9-pin RS-232 Protocol: DF1 or DH-485 (point-to-point)	Port: CH1 Protocol: DH+	Port: CH1 - Ethernet - RJ45 Protocol: EtherNet/IP
PanelView Plus 6 Compact 400, 600, 1000	Requires 1761-NET-AIC module, and 2711-NC13 (5 m/16 ft) or 2711-NC14 (10 m/32 ft) cable	2711-NC13 (5 m/16 ft) 2711-NC14 (10 m/32 ft)	—	1585J-M type cable or 2711P-CBL-EX04 (4 m/14 ft)
PanelView Plus 6 400, 600			—	
PanelView Plus 6 700, 1000, 1250, 1500			Requires 2711P-RN6 or 2711P-RN6K module, with shielded twinaxial cable (1770-CD)	

Communication Cables: PanelView Plus 6 Terminals to MicroLogix Controllers

	MicroLogix 1400, 1500LRP	MicroLogix 1000, 1100, 1200, 1400, 1500LSP	MicroLogix 1100, 1400
	Port: CH1/CH2 - 9-pin RS-232 Protocol: DF1 or DH-485 (point-to-point)	Port: CH0 - 8-pin Mini-DIN Protocol: DF1 or DH-485 (point-to-point)	Port: Ethernet - RJ45 Protocol: EtherNet/IP
PanelView Plus 6 Compact 400, 600, 1000	2711-NC13 (5 m/16 ft) or 2711-NC14 (10 m/32 ft) cable (Requires DB9 to DB25 adapter)	2711-NC21 (5 m/16 ft) or 2711-NC22 (15 m/49 ft)	1585J-M type cable or 2711P-CBL-EX04 (4 m/14 ft)
PanelView Plus 6 400, 600			
PanelView Plus 6 700, 1000, 1250, 1500			

Communication Cables: PanelView Plus 6 Terminals to CompactLogix Controllers

	CompactLogix	CompactLogix L35E, L23E, L32E, 1768-ENBT	CompactLogix L35CR, L32C, 1768-CNB, 1768-CNBR
	Port: CH0 - 9-pin RS-232 Protocol: DF1 or DH-485 (point-to-point)	Port: Ethernet - RJ45 Protocol: EtherNet/IP	Port: ControlNet Port Protocol: ControlNet
PanelView Plus 6 Compact 400, 600, 1000	2711-NC13 (5 m/16 ft) 2711-NC14 (10 m/32 ft)	1585J-M type cable or 2711P-CBL-EX04 (4 m/14 ft)	1786 ControlNet media
PanelView Plus 6 400, 600			
PanelView Plus 6 700, 1000, 1250, 1500			

Communication Cables: PanelView Plus 6 Terminals to ControlLogix Controllers

	ControlLogix	ControlLogix	ControlLogix	ControlLogix
	Port: CH0 - 9-pin RS-232 Protocol: DF1 or DH-485 (point-to-point)	Communication Module: 1756-ENBT, 1756-EN2T Protocol: EtherNet/IP	Communication Module: 1756-CNB Protocol: ControlNet	Communication Module: 1756-DHRIO Protocol: DH+
PanelView Plus 6 Compact 400, 600, 1000	2711-NC13 (5 m/16 ft) 2711-NC14 (10 m/32 ft)	1585J-M type cable or 2711P-CBL-EX04 (4 m/14 ft)	1786 ControlNet media	—
PanelView Plus 6 400, 600				—
PanelView Plus 6 700, 1000, 1250, 1500				Shielded twinaxial cable (1770-CD)

Communication Cables: PanelView Plus 6 Terminals to Interface Modules

Protocol	PanelView Plus 6 Comm Port 400, 600 700, 1000, 1250, 1500	1747-AIC	1761-NET-AIC			1761-NET-ENI
			Port 1 (9-pin)	Port 2 (8-pin Mini DIN)	Port 3 (DH-485)	Port 2 (8-pin Mini DIN)
DF1	RS-232 port All terminals	—	2711-NC13 (5 m/16 ft) 2711-NC14 (10 m/32 ft)	2711-NC21 (5 m/16 ft) 2711-NC22 (15 m/49 ft) Null modem required	—	1761-CBL-AP00 (5 m) 1761-CBL-PM02 (2 m) 2711-CBL-PM05 (5 m) 2711-CBL-PM10 (10 m)
DH-485	RS-232 port All terminals	—	2711-NC13 (5 m/16 ft) 2711-NC14 (10 m/32 ft)	2711-NC21 (5 m/16 ft) 2711-NC22 (15 m/49 ft) Null modem required	—	—
	DH-485 port 700...1500 terminals only Requires 2711P-RN6 or 2711P-RN6K	Direct connection to single AIC with Belden 9842 cable ⁽¹⁾	—	—	Direct connection to single AIC+ with Belden 9842 cable ⁽¹⁾	—

(1) Use the serial port on the PanelView Plus 6 terminal with an AIC+ module for a DH-485 network solution.

PanelView 800 and PanelView Component Terminals

This section lists the cables that can be used to connect PanelView 800 and PanelView Component terminals to various controllers.

Cables for PanelView 800 and PanelView Component Terminals

Cat. No.	Description	For Use With
2711C-CBL-UU02	USB-A host to USB-B device cable, 2 m (6.5 ft)	C200, C300
2711P-CBL-EX04	Ethernet crossover CAT5 cable, 4.3 m (14 ft)	PanelView 800: 4-in, 7-in., and 10-in.
1747-CP3	Serial 9-pin D-shell to 9-pin D-shell null modem cable, 3 m (10 ft)	C200, C300 PanelView 800: 4-in, 7-in., and 10-in.
1761-CBL-PM02	Serial 9-pin D-shell to 8-pin mini DIN cable, 2 m (6.5 ft)	
2711C-CBL-AB03	RS-485 5-pin to RJ45 cable	
1763-NC01 series A	8-pin Mini DIN to 6-pin RS-485 terminal block	PanelView 800: 4-in, 7-in., and 10-in.

Communication Cables: PanelView 800 and PanelView Component Terminals to MicroLogix Controllers⁽¹⁾

Protocol	Port	MicroLogix (8-pin Mini DIN) 1000, 1100, 1400, 1200LSP, 1500LSP (CH0)	MicroLogix (9-pin D-shell) 1500LRP (CH1)	MicroLogix 1100/1400 RS-485 (1763-NC01)	MicroLogix 1100, 1400 Ethernet
DF1				—	
DH-485	RS-232	1761-CBL-PM002	1747-CP3	Use AIC+ module (1761-NET-AIC) connect to port 3	—
	RS-485 ⁽²⁾	—	—	Belden 3106A or #9842 or equivalent	
Modbus	RS-232	1761-CBL-PM002	1747-CP3	Use AIC+ module (1761-NET-AIC) connect to port 3	
Ethernet (MicroLogix/ENI)2	Ethernet	—	—	—	CAT5 Ethernet

(1) The communication cables that are listed in this table are also used to connect PanelView 800 terminals to MicroLogix controllers.

(2) RS-485 is isolated and is recommended for connecting to only one device with an isolated port.

Communication Cables: PanelView 800 Terminals to Micro800 Controllers

Protocol	PanelView 800 Port	Micro820	Micro830	Micro850	Micro800 Plug-in Module (2080-SERIALISOL)
Modbus (RTU) (HD)	RS-232	— ⁽²⁾	1761-CBL-PM02	1761-CBL-PM02	— ⁽²⁾
	RS-485 ⁽¹⁾		— ⁽²⁾	— ⁽²⁾	
Modbus unsolicited (HD)	RS-232		1761-CBL-PM02	1761-CBL-PM02	
	RS-485 ⁽¹⁾		— ⁽²⁾	— ⁽²⁾	
Ethernet (AB CIP)	Ethernet	2711P-CBL-EX04 (CAT5 Ethernet)	N/A ⁽³⁾	2711P-CBL-EX04 (CAT5 Ethernet)	N/A ⁽³⁾
Modbus TCP					
Serial (AB CIP)	RS-232	— ⁽²⁾	1761-CBL-PM02	1761-CBL-PM02	— ⁽²⁾

(1) RS-485 is isolated and is recommended for connecting to only one device with an isolated port.

(2) This controller includes a terminal block and requires wiring.

(3) This connectivity is not available for this controller.

Communication Cables: PanelView 800 Terminals to CompactLogix 5370 Controllers

Protocol (CIP)	PanelView 800 Port	CompactLogix 5370 L1
Ethernet (CompactLogix)	2711P-CBL-EX04 (CAT5 Ethernet)	2711P-CBL-EX04 (CAT5 Ethernet)

Notes:

VersaView 5000 Computers



The Allen-Bradley® VersaView® 5000 portfolio is a complete line of open architecture industrial PCs, thin clients, and monitors. Offerings include integrated modern edge-to-edge all-glass displays and compact non-display models. The VersaView 5000 platform can be used for both standalone machine level and distributed HMI applications. The open architecture supports modern operating systems and various software applications, but the ideal deployment is to use FactoryTalk® View SE software for distributed applications. The line is completely fanless and maintenance free to reduce costly machine downtime.

VersaView 5200 Compact Non-display ThinManager Thin Clients

The VersaView 5200 compact non-display computers offer a small footprint, dual video output, and a light-weight, fanless design. In addition, they provide multiple mounting options, including DIN Rail.

Terminal Features and Terminal Selection

Features	Description			
	6200T-BA	6200T-NA, 6200T-NAK	6200T-KB	6200T-RC, 6200T-RE
External Display Output	Single	Dual	Dual 4K	Multi 4K Display
Processor	Intel single core Atom E3815; 1.46Ghz		Intel quad core Atom x7-E3950	Intel quad core i5-7500T
RAM	2 GB	1 GB	4 GB	
Storage	None			
Optical Storage	None			
Expansion Slots	None			
I/O Ports	1x DisplayPort 1x VGA 2x USB 2.0 1x USB 3.0 1x RS-232 2x 1Gb Ethernet			
Operating System	ThinManager Ready			
Power	100-240V AC external adapter included	24V DC		
Operating Temperature	0...50 °C (32...122 °F)	-20...+60 °C (-4...+140 °F)	0...55 °C (32...131 °F)	0...45 °C (32...113 °F)
Certifications/Regulations	CE, cULus Listed, EAC, KC, and RCM	CE, cULus Listed Class 1/Div 2, ATEX 2/22, EAC, KC, RCM, and BIS	CE, cULus Listed, EAC, KC, and RCM	
Mounting Options	Wall, VESA, DIN Rail, Bookshelf, Machine			Machine
Conformal Coat	Not Available	Optional	Not Available	

For complete technical specifications, certifications, and environmental specifications on the VersaView computers, see the Industrial Computers and Monitors Specifications Technical Data, publication [IC-TD001](#).

For information about accessories that are available for these terminals, see page [78](#).

VersaView 5200 Integrated Display ThinManager Thin Clients

The VersaView 5200 integrated-display computers provide an edgeless, all-glass, ten-point, multi-touch screen. This design keeps the computers cleaner and helps them respond better to users. Additional features include:

- Dual external-display support
- Available in 12 in., 15 in., 19 in., 22 in. sizes, all in wide-screen orientation
- Full, high-definition resolution available at 1920 x 1080
- Plant PAX and FactoryTalk View SE templates perfectly fit the 1080p screen, allowing identical screens to be shared between the control room and the machine

Terminal Features

Features	Description
Processor	Intel single core Atom E3815; 1.46Ghz
RAM	2 GB
Storage	None
Optical Storage	None
Expansion Slots	None
I/O Ports	1x DisplayPort 2x USB 2.0 1x USB 3.0 1x RS-232 2x 1Gb Ethernet
Power	24V DC
Operating System	ThinManager Ready

Terminal Selection

Cat. No.	Display Size	Aspect Ratio	Bezel Type	Storage	Windows Operating System	Power
6200T-12WA	12.1 in.	16:9 Widescreen	Glass front and aluminum ring	None	ThinManager Ready	24V DC
6200T-15WA	15.6 in.					
6200T-19WA	18.5 in.					
6200T-22WA	21.5 in.					

For complete technical specifications, certifications, and environmental specifications on the VersaView computers, see the Industrial Computers and Monitors Specifications Technical Data, publication [IC-TD001](#).

For information about accessories that are available for these terminals, see page [78](#).

VersaView 5400 Compact Non-display Computers

The VersaView 5400 compact non-display computers offer a small footprint, dual video output, and a light-weight, fanless design. With the same performance as the integrated display computers and the flexibility to load a variety of software applications, the non-display computers are well-suited for many applications. In addition, they provide multiple mounting options, including DIN Rail.

Terminal Features

Features	Description
Processor	Intel quad core Atom E3845; 1.91Ghz
RAM	4 GB
Storage	128GB MLC SSD
Optical Storage	None
Expansion Slots	None
I/O Ports	1x DisplayPort 1x VGA 2x USB 2.0 1x USB 3.0 1x RS-232 2x 1Gb Ethernet
Power	24V DC
Operating System	Windows 7 SP1 (64bit) Windows Embedded Standard 7 (64bit) Windows 10 IoT Enterprise (64bit)

Terminal Selection

Cat. No.	Display Size	Aspect Ratio	Bezel Type	Storage	Windows Operating System	Power
6200P-NS3A1	—	—	—	128 GB MLC SSD	Windows 7 SP1 (64-bit)	12...24V DC
6200P-NS3A1K ⁽¹⁾						
6200P-NS3B1					Windows Embedded Standard 7 (64-bit)	
6200P-NS3B1K ⁽¹⁾						
6200P-NS3C1					Windows 10 IoT Enterprise (64-bit)	
6200P-NS3C1K ⁽¹⁾						

(1) This model includes conformal coating.

For complete technical specifications, certifications, and environmental specifications on the VersaView computers, see the Industrial Computers and Monitors Specifications Technical Data, publication [IC-TD001](#).

For information about accessories that are available for these terminals, see page [78](#).

VersaView 5400 Integrated Display Computers

The VersaView 5400 integrated-display computers provide an edgeless, all-glass, ten-point, multi-touch screen. This design keeps the computers cleaner and helps them respond better to users. Additional features include:

- Boots quickly into your application
- 128 GB SSD offers plenty of capacity for applications
- Windows 7/WES 7/Windows 10 IoT Enterprise 32 bit and 64 bit operating systems

Terminal Features

Features	Description
Processor	Intel quad core Atom E3845; 1.91Ghz
RAM	4 GB
Storage	128GB MLC SSD
Optical Storage	None
Expansion Slots	None
I/O Ports	1x DisplayPort 2x USB 2.0 1x USB 3.0 1x RS-232 2x 1Gb Ethernet
Power	24V DC
Operating System	Windows 7 Pro SP1 (64 bit) Windows Embedded Standard 7 (64 bit) Windows 10 IoT Enterprise (64 bit)

Terminal Selection — Integrated-display Computers

Cat. No.	Display Size	Aspect Ratio	Bezel Type	Storage	Windows Operating System	Power
6200P-12WS3A1	12.1 in.	16:9 Widescreen	Glass front and aluminum ring	128 GB MLC SSD	Windows 7 SP1 (64-bit)	24V DC
6200P-12WS3B1					Windows Embedded Standard 7 (64-bit)	
6200P-12WS3C1					Windows 10 IoT Enterprise (64-bit)	
6200P-15WS3A1	15.6 in.				Windows 7 SP1 (64-bit)	
6200P-15WS3B1					Windows Embedded Standard 7 (64-bit)	
6200P-15WS3C1					Windows 10 IoT Enterprise (64-bit)	
6200P-19WS3A1	18.5 in.				Windows 7 SP1 (64-bit)	
6200P-19WS3B1					Windows Embedded Standard 7 (64-bit)	
6200P-19WS3C1					Windows 10 IoT Enterprise (64-bit)	
6200P-22WS3A1	21.5 in.				Windows 7 SP1 (64-bit)	
6200P-22WS3B1					Windows Embedded Standard 7 (64-bit)	
6200P-22WS3C1					Windows 10 IoT Enterprise (64-bit)	

For complete technical specifications, certifications, and environmental specifications on the VersaView computers, see the Industrial Computers and Monitors Specifications Technical Data, publication [IC-TD001](#).

For information about accessories that are available for these terminals, see page [78](#).

6181P Integrated Display Computers



When you require a view into your operations, Rockwell Automation® integrated display computers serve as the foundation for visualization control of processes and machinery by using information displays to repair, maintain, or start a process. Industrially rated components are selected to ensure continuous operation in the most demanding environments. Fanless designs are available for mission-critical applications. Integrated display computers provide seamless integration with the full suite of Rockwell Software® solutions, including the Integrated Architecture® platform and FactoryTalk® View software.

Performance Models (Series F)

Performance models are equipped with features designed to meet the most demanding integrated display computer needs:

- MLC or SLC solid-state drives with both AC and DC power input options
- 12-, 15-, 17-, or 19-inch display options
- Stainless steel NEMA 4X options
- Non-display options are available
- Lockable front-accessible USB 3.0 port
- Core i3 processor and expandable memory up to 16 GB
- Expansion options through a PCIe slot and an accessory kit for adding PCI or additional PCIe
- CompactFlash Type II slot with cover
- Rated to 55 °C (131 °F) for 12-, 15-, and 17-inch displays, and 50 °C (122 °F) for 19-inch displays
- Flush panel design minimizes debris buildup
- Single-touch resistive touch screens
- Front user interface button

Advanced Models (Series F)

Advanced models offer many of the same features as the Performance models, but the Advanced models include greater computing capacity:

- MLC or SLC solid-state drives with both AC and DC power input options
- 15-, 17-, or 19-inch display options, including 15-inch and 19-inch wide screen versions
- Core i7 processor and expandable memory up to 16 GB
- CompactFlash Type II slot with cover
- Expansion options through a PCIe slot and an accessory kit for adding PCI or additional PCIe
- Rated to 0...50 °C (32...122 °F) for 15-inch and 19-inch widescreen models and 19-inch non-widescreen models
- Rated 0...55 °C (32...131 °F) for 15-inch and 17-inch non-widescreen models
- Multi-touch capacitive touch screens
- Front user interface button
- RAID server model available

Terminal Features

Features	Description	
	Performance	Advanced
Processor	Intel i3-4102E; two cores; 1.6 GHz	Intel i7-4700EQ; four cores; 2.4 GHz
RAM	4 GB (2x 2 GB) ⁽¹⁾	8 GB (2 x 4 GB) ⁽¹⁾
Storage	Solid State - 1x 32 GB SLC, 2.5 in. SATA SSD Solid State - 1x 256 GB MLC, 2.5 in. SATA SSD	Solid State - 1x 32 GB SLC, 2.5 in. SATA SSD Solid State - 1x 256 GB MLC, 2.5 in. SATA SSD RAID - 2x 256 GB, 2.5 in. SATA SSD
Optical Storage	None supplied, but can be added via the 6189V-ODD kit	1 DVD-RW/CD-RW
Expansion Slots	1 PCI Express x8 (upgradable to 1 PCI, 2PCI, 2 PCIe x4, or 1 PCIe x4+ 1 PCI with Separate PCI riser kits)	1 PCI Express x8 (upgradable to 1 PCI, 2PCI, 2 PCIe x4, or 1 PCIe x4+ 1 PCI with Separate PCI riser kits)
Power	AC or DC	
Operating System	Windows 7 SP1 (64-bit) or Windows 10 IoT Enterprise LTSB (64-bit)	
	Windows Embedded Standard 7	Windows Server 2008 R2 SP1

(1) Can be upgraded to 16 GB RAM.

For complete technical specifications, certifications, and environmental specifications on the industrial computers and monitors, refer to the Industrial Computers and Monitors Specifications Technical Data, publication [IC-TD001](#).

Terminal Selection — 6181P Integrated Display Computers - Performance Models (Series F)

Model	Cat. No.	Display Size	Aspect Ratio	Bezel Type	Storage	Windows Operating System	Power
Non-display	6181P-00N2MW71AC	—	—	—	256 GB MLC SSD	Windows 7 SP1 (64-bit)	AC
	6181P-00N2MW71DC						DC
	6181P-00N2MWX1AC					Windows 10 IoT Enterprise LTSB (64-bit)	AC
	6181P-00N2MWX1DC						DC
	6181P-00N2SW71AC				32 GB SLC SSD	Windows 7 SP1 (64-bit)	AC
	6181P-00N2SW71DC						DC
	6181P-00N2SE71AC					Windows Embedded Standard 7	AC
	6181P-00N2SE71DC						DC
	6181P-00N3MWX1AC				256 GB MLC SSD	Windows 10 IoT Enterprise LTSB (64-bit)	AC
	6181P-00N3MWX1DC						DC

Terminal Selection — 6181P Integrated Display Computers - Performance Models (Series F)

Model	Cat. No.	Display Size	Aspect Ratio	Bezel Type	Storage	Windows Operating System	Power					
12-inch	6181P-12A2MW71AC	12.1 in.	4:3	Aluminum	256 GB MLC SSD	Windows 7 SP1 (64-bit)	AC					
	DC											
	Windows 10 IoT Enterprise LTSB (64-bit)					AC						
						DC						
	6181P-12A2SW71AC				6181P-12A2SE71AC	6181P-12A2SW71DC	6181P-12A2SE71DC	32 GB SLC SSD	Windows 7 SP1 (64-bit)	AC		
										DC		
									Windows Embedded Standard 7	AC		
										DC		
15-inch	6181P-15A2MW71AC	15 in.	4:3	Aluminum	256 GB MLC SSD	Windows 7 SP1 (64-bit)	AC					
	DC											
	Windows 10 IoT Enterprise LTSB (64-bit)					AC						
						DC						
	6181P-15C2MW71AC					6181P-15C2MW71DC	6181P-15C2MWX1AC	6181P-15C2MWX1DC	Stainless Steel	32 GB SLC SSD	Windows 7 SP1 (64-bit)	AC
												DC
											Windows 10 IoT Enterprise LTSB (64-bit)	AC
												DC
	6181P-15A2SW71AC			6181P-15A2SW71DC	6181P-15A2SE71AC	6181P-15A2SE71DC	Aluminum	32 GB SLC SSD	Windows 7 SP1 (64-bit)	AC		
										DC		
									Windows Embedded Standard 7	AC		
										DC		
	6181P-15C2SW71AC			6181P-15C2SW71DC	6181P-15C2SW71AC	6181P-15C2SW71DC	Stainless Steel	32 GB SLC SSD	Windows 7 SP1 (64-bit)	AC		
										DC		
									Windows Embedded Standard 7	AC		
										DC		

Terminal Selection — 6181P Integrated Display Computers - Performance Models (Series F)

Model	Cat. No.	Display Size	Aspect Ratio	Bezel Type	Storage	Windows Operating System	Power
17-inch	6181P-17A2MW71AC	17 in.	5:4	Aluminum	256 GB MLC SSD	Windows 7 SP1 (64-bit)	AC
	DC						
	Windows 10 IoT Enterprise LTSB (64-bit)					AC	
						DC	
	Stainless Steel			Windows 7 SP1 (64-bit)		AC	
						DC	
				Windows 10 IoT Enterprise LTSB (64-bit)		AC	
						DC	
	Aluminum			32 GB SLC SSD	Windows 7 SP1 (64-bit)	AC	
						DC	
					Windows Embedded Standard 7	AC	
						DC	
	256 GB MLC SSD			Windows 10 IoT Enterprise LTSB (64-bit)	AC		
					DC		
	Stainless Steel			32 GB SLC SSD	Windows 7 SP1 (64-bit)	AC	
						DC	
DC							
DC							
19-inch	6181P-19A2MW71AC	19 in.	5:4	Aluminum	256 GB MLC SSD	Windows 7 SP1 (64-bit)	AC
	DC						
	Windows 10 IoT Enterprise LTSB (64-bit)					AC	
						DC	
	Stainless Steel			Windows 7 SP1 (64-bit)		AC	
						DC	
				Windows 10 IoT Enterprise LTSB (64-bit)		AC	
						DC	
	Aluminum			32 GB SLC SSD	Windows 7 SP1 (64-bit)	AC	
						DC	
					Windows Embedded Standard 7	AC	
						DC	
	256 GB MLC SSD			Windows 10 IoT Enterprise LTSB (64-bit)	AC		
					DC		
	Stainless Steel			32 GB SLC SSD	Windows 7 SP1 (64-bit)	AC	
						DC	
DC							
DC							

Terminal Selection — 6181P Integrated Display Computers - Advanced Models (Series F)

Model	Cat. No.	Display Size	Aspect Ratio	Bezel Type	Storage	Windows Operating System	Power	
Non-display	6181P-00N3MW71AC	—	—	—	256 GB MLC SSD	Windows 7 SP1 (64-bit)	AC	
	6181P-00N3MW71DC					DC		
	6181P-00N3MWX1AC					Windows 10 IoT Enterprise LTSB (64-bit)	AC	
	6181P-00N3MWX1DC					DC		
	6181P-00N3SW71AC				32 GB SLC SSD	Windows 7 SP1 (64-bit)	AC	
	6181P-00N3SW71DC					DC		
	6181P-00N3MS81AC					RAID ⁽¹⁾	Windows Server 2008 R2 SP1	AC
	6181P-00N3MS81DC					DC		
15-inch	6181P-15A3MW71AC	15 in.	4:3	Aluminum	256 GB MLC SSD	Windows 7 SP1 (64-bit)	AC	
	6181P-15A3MW71DC					DC		
	6181P-15A3MWX1AC					Windows 10 IoT Enterprise LTSB (64-bit)	AC	
	6181P-15A3MWX1DC					DC		
	6181P-15A3SW71AC				32 GB SLC SSD	Windows 7 SP1 (64-bit)	AC	
	6181P-15A3SW71DC					DC		
	6181P-15B3MW71AC	15.6 in.	16:9		256 GB MLC SSD	Windows 7 SP1 (64-bit)	AC	
	6181P-15B3MW71DC					DC		
	6181P-15B3MWX1AC					Windows 10 IoT Enterprise LTSB (64-bit)	AC	
	6181P-15B3MWX1DC					DC		
	6181P-15B3SW71AC				32 GB SLC SSD	Windows 7 SP1 (64-bit)	AC	
	6181P-15B3SW71DC					DC		
17-inch	6181P-17A3MWX1AC	17 in.	4.3	Aluminum	256 GB MLC SSD	Windows 10 IoT Enterprise LTSB (64-bit)	AC	
	6181P-17A3MWX1DC		5:4			DC		
	6181P-17A3MW71AC					Windows 7 SP1 (64-bit)	AC	
	6181P-17A3MW71DC		DC					
	6181P-17A3SW71AC		32 GB SLC SSD		Windows 7 SP1 (64-bit)	AC		
	6181P-17A3SW71DC				DC			
19-inch	6181P-19A3MW71AC	19 in.	4.3		Aluminum	256 GB MLC SSD	Windows 10 IoT Enterprise LTSB (64-bit)	AC
	6181P-19A3MW71DC						5:4	DC
	6181P-19A3MWX1AC							Windows 7 SP1 (64-bit)
	6181P-19A3MWX1DC		DC					
	6181P-19A3SW71AC		32 GB SLC SSD			Windows 7 SP1 (64-bit)	AC	
	6181P-19A3SW71DC					DC		
	6181P-19B3MW71AC	18.5 in.	16:9	256 GB MLC SSD		Windows 7 SP1 (64-bit)	AC	
	6181P-19B3MW71DC					5:4	DC	
	6181P-19B3MWX1AC						Windows 10 IoT Enterprise LTSB (64-bit)	AC
	6181P-19B3MWX1DC					DC		
	6181P-19B3SW71AC			32 GB SLC SSD		Windows 7 SP1 (64-bit)	AC	
	6181P-19B3SW71DC					DC		

(1) RAID = Redundant Array of Independent Disks

For information about accessories that are available for these terminals, see page [78](#).

Notes:

Hazardous Location Computers



Non-display Version

Analog Resistive Display

PCAP Display

This extreme environment computer combines safety with extended operating temperature ratings. Industries from oil and gas to chemicals and mining must regularly work with potentially explosive materials, in locations where hardware often takes a beating. These computers are designed to endure the harsh extremes of heat and cold.

With Class 1 Division 2, ATEX, INMETRO, and IECEx hazardous location certification, the extreme environment computer can be safely used globally in areas where explosive materials may be present. The display version of this computer is panel mounted while the non-display version mounts within an enclosure or cabinet. Both can withstand temperatures between -20...70 °C (-4...158 °F) inside a cabinet or enclosure. The surface temperature of the front of the display computer can withstand ambient temperatures in the range -20...55 °C (-4...131 °F).

Terminal Features

Features	Description	
	Series F/G	Series H
Processor	Core Duo U2500, 1.2GHz	i3-5010u 2.1 GHz
RAM	2 GB (4 GB max)	8 GB (16 GB max)
Optical Storage	16 GB SSD	128 GB SSD
Display	12-in. touch screen, 800 x 600, resistive anti-glare, sunlight readable (non-display option available)	12-in. touch screen, 1024 x 768, resistive anti-glare, projected capacitive anti-glare, sunlight readable (non-display option available)
Expansion Slots	1 half-length PCI	PCI-Express (1 slot)
I/O	4 USB 2.0, 2x RS-232, 2x Gigabit Ethernet, CompactFlash, DVI (single video output)	4 USB 3.0, 2x RS-232, 2x Gigabit Ethernet, CompactFlash, DVI & DisplayPort (dual video output)
Power	DC	DC
Operating System	Windows 7 Professional (32-bit), Service Pack 1	Windows 7 Professional (64-bit) or Windows 10 IoT Enterprise LTSB (64-bit) 6181X PCAP is offered with Windows 10 IoT Enterprise LTSC (64-bit)

Terminal Selection

Model	Cat. No.	Display Size	Storage Drive	Operating System	Power	Mounting
1200XT Series F/G	6181X-12TPW7DC	12.1-in. TFT display	16 GB SSD ⁽¹⁾	Windows 7 Professional (32-bit), Service Pack 1	DC	Panel
	6181X-NPW7DC	Non-display				Wall
1200XT Series H	6181X-12A2SW71DC	12.1-in. TFT display	128 GB SSD ⁽¹⁾	Windows 7 Professional (64-bit)		Panel
	6181X-00N2SW71DC	Non-display				Wall
	6181X-12A2SWX1DC	12.1-in. TFT display		Windows 10 IoT Enterprise LTSB (64-bit)		Panel
	6181X-00N2SWX1DC	Non-display				Wall
	6181X-12P2SWX1DC	12.1 in TFT display (PCAP)			Windows 10 IoT Enterprise LTSC (64-bit)	Panel

(1) CompactFlash Type 2 slot available.

Notes:

Non-display Computers



6177R non-display computers take advantage of the Intel second-generation core processors to provide powerful, highly-reliable platforms suited for industrial environments. These computers are available in rugged machine-mount (750R) and rack-mount (1450R) form factors and offer powerful remote management, onboard backup/restore, and integrated diagnostic capabilities. Numerous expansion slots extend the versatility of these computers.

Terminal Features

Features	Description	
	750R Model	1450R Model
Processor	Intel Core i3-2120, 3.3 GHz Or Intel Core i5-2400, 3.1 GHz	
RAM	4 GB (32 GB max) Or 8 GB (32 GB max)	
Optical Storage	DVD-RW	
Expansion Slots	<ul style="list-style-type: none"> • 1 PCI • 1 PCI Express x16 • 1 PCI Express x4 • 1 PCI Express x1 	<ul style="list-style-type: none"> • 4 PCI • 1 PCI Express x16 • 1 PCI Express x4 • 1 PCI Express x 1
Power	AC	
Operating System	No Operating System Windows 10 IoT Enterprise LTSB (64-bit) Windows 7 Professional (64 bit) SP1 Windows Server 2008 R2 (64 bit) SP1 Windows 8.1 Industry Pro (64 bit) Windows Server 2012 Standard R2 (64 bit)	

For complete technical specifications, certifications, and environmental specifications on the industrial computers and monitors, refer to the Industrial Computers and Monitors Specifications Technical Data, publication [IC-TD001](#).

Terminal Selection — 750R Machine-mount Non-display Computers

Model	Cat. No.	Package Features	Windows Operating System	Processor	RAM	Hard Disk Drive
750R	6177R-MMPWX	Performance	Windows 10 IoT Enterprise LTSB (64-bit)	Intel Core i3-2120 3.3 GHz	4 GB 32 GB max	1 TB
	6177R-MMPXP		Windows XP Professional SP (32 bit)			
	6177R-MMPW7		Windows 7 Professional (64 bit) SP1			
	6177R-MMPN0		No Operating System			
	6177R-MMAW7	Advanced	Windows 7 Professional (64 bit) SP1	Intel Core i5-2400 3.1 GHz	8 GB 32 GB max	1 TB ⁽¹⁾
	6177R-MMSS8	Server	Windows Server 2008 R2 (64 bit) SP1			
	6177R-MMSN0		No Operating System			
	6177R-MMAWX	Advanced	Windows 10 IoT Enterprise LTSB (64-bit)			
	6177R-MMAW8		Windows 8.1 Industry Pro (64 bit)			
	6177R-MMS12	Server	Windows Server 2012 Standard R2 (64 bit)			

(1) Enabled for RAID 1 operation.

Terminal Selection — 1450R Rack-mount Non-display Computers

Model	Cat. No.	Mounting	Package Features	Windows Operating System	Processor	RAM	Hard Disk Drive
1450R	6177R-RMPWX	4U Rack	Performance	Windows 10 IoT Enterprise LTSB (64-bit)	Intel Core i3-2120 3.3 GHz	4 GB 32 GB max	1 TB
	6177R-RMPW7			Windows 7 Professional (64 bit) SP1			
	6177R-RMPNO			No Operating System			
	6177R-RMAW7		Advanced	Windows 7 Professional (64 bit) SP1	Intel Core i5-2400 3.1 GHz	8 GB 32 GB max	1 TB ⁽¹⁾
	6177R-RMSS8		Server	Windows Server 2008 R2 (64 bit)SP1			
	6177R-RMSNO			No Operating System			
	6177R-RMAW8		Advanced	Windows 8.1 Industry Pro (64 bit)			
	6177R-RMAWX			Windows 10 IoT Enterprise LTSB (64-bit)			
	6177R-RMS12		Server	Windows Server 2012 Standard R2 (64 bit)	1 TB ⁽¹⁾		

(1) Enabled for RAID 1 operation.

For information about accessories that are available for these terminals, see page [81](#).

VersaView 5100 Monitors



The VersaView® 5100 industrial monitors provide edgeless, all-glass, ten-point, multi-touch screens. This design keeps the computers cleaner and helps them respond better to users.

Additional features include:

- Native support for DisplayPort, DVI, and VGA video connections
- Widescreen 16:9 displays for modern application content
- Pre-calibrated, ten-point multi-touch screen that never require recalibration
- Tempered-glass and stainless-steel construction suitable for NEMA 4X and IP66 applications

Terminal Selection

Cat. No.	Display Size	Resolution	Bezel Type	Mounting	Projected Capacitive Touchscreen
6200M-12WBN	12.1 in.	1280 x 800	Tempered glass with stainless steel ring	Panel (IP66/ NEMA 4X) VESA (IP20)	Yes Ten-point multi-touch
6200M-15WBN	15.6 in.	1366 x 768			
6200M-19WBN	18.5 in.				
6200M-22WBN	21.5 in.	1920 x 1080			

For complete technical specifications, certifications, and environmental specifications on the industrial computers, see the Industrial Computers and Monitors Specifications Technical Data, publication [IC-TD001](#).

Notes:

Industrial Monitors

Industrial monitors deliver the latest in LCD technology for rugged industrial environments. Combine these monitors with any of the Rockwell Automation® non-display computers to create a powerful visualization, maintenance, control, or information computing solution:

- The performance monitors are ideal for special purpose environments such as UL Class I Division II, and food and beverage areas, providing excellent protection against heat, shock, and vibration. Combine with the 6181X hazardous location computer for a complete system solution.
- The standard monitors are suited for control-room and non-hazardous location use.
- Cables and power supplies are included with these monitors.



Performance Monitors



Standard Monitors



For complete technical specifications, certifications, and environmental specifications on the industrial computers and monitors, refer to the Industrial Computers and Monitors Specifications Technical Data, publication [IC-TD001](#).

Terminal Selection — 6176M Standard Monitors

Model	Cat. No.	Display Size	Mounting	Resistive Touch Screen	Bezel
1550M	6176M-15PN	15-in. TFT LCD display	Panel		Aluminum
	6176M-15PT			x	
	6176M-15VN		VESA		Plastic
	6176M-15VT			x	
1750M	6176M-17PN	17-in. TFT LCD display	Panel		Aluminum
	6176M-17PT			x	
	6176M-17VN		VESA		Plastic
	6176M-17VT			x	
1950M	6176M-19PN	19-in. TFT LCD display	Panel		Aluminum
	6176M-19PT			x	
	6176M-19VN		VESA		Plastic
	6176M-19VT			x	

Terminal Selection — 6186M Performance Monitors

Model	Cat. No.	Display Size	Mounting	Resistive Touch Screen	Bezel
1200M	6186M-12PN	12.1-in. TFT LCD display	Panel		Aluminum
	6186M-12PT			x	
1500M	6186M-15PN	15-in. TFT LCD display			Aluminum
	6186M-15PT			x	
	6186M-15PNSS				Stainless Steel
	6186M-15PTSS			x	
1700M	6186M-17PN	17-in. TFT LCD display			Aluminum
	6186M-17PT			x	
	6186M-17PNSS				Stainless Steel
	6186M-17PTSS			x	
1900M	6186M-19PN	19-in. TFT LCD display			Aluminum
	6186M-19PT			x	
	6186M-19PNSS			Stainless Steel	
	6186M-19PTSS		x		

For information about accessories that are available for these terminals, see page [81](#).

Industrial Computer Accessories

VersaView 5000 Computers and VersaView 5100 Monitors

The following tables list accessories for the VersaView® 5000 computers and the VersaView 5100 monitors.

Power Supply

Cat. No.	Description	For Use With
6200V-MPS4	90W External AC or DC Power Supply	VersaView 5100 Monitors VersaView 5200 Compact Non-display Computers VersaView 5200 Integrated-display Computers VersaView 5400 Compact Non-display Computers VersaView 5400 Integrated-display Computers
6200V-MPS5	Replacement AC to DC power adapter	6200T-BA
6200V-MPS6	AC to 40W, 24V DC power adapter	All except 6200T-BA, 6200P-22WS3x1

Mounting Hardware

Cat. No.	Description	For Use With
6200V-MCLPS4	Replacement Mounting Clips, 14	VersaView 5100 Monitors VersaView 5200 Integrated-display Computers VersaView 5400 Integrated-display Computers
6200V-BXDIN	DIN Rail Mounting Bracket Kit	VersaView 5200 Compact Non-display Computers VersaView 5400 Compact Non-display Computers
6200V-BXWALL	Wall Mounting Bracket Kit	
6200V-BXMACH	Machine Mounting Bracket Kit	
6200V-BXLGKY	6155R Legacy Mounting Bracket Kit	
6200V-BXVESA	VESA Mounting Bracket Kit	
6200V-BXMACH2	VersaView 5200 Multi 4K Machine Mounting Kit	6200T-RC, 6200T-RE
6200V-BXWALL2	VersaView 5200 Single-Display Wall Bracket	6200T-BA
6200V-BXDIN2	VersaView 5200 Single-Display DIN Rail Bracket	
6200V-BXVESA2	VersaView 5200 Single-Display VESA Bracket	

Cables

Cat. No.	Description	For Use With
6200V-DPCBL2M	DisplayPort Cable, 2 m (6.5 ft)	VersaView 5100 Monitors VersaView 5200 Compact Non-display Computers VersaView 5200 Integrated-display Computers VersaView 5400 Compact Non-display Computers VersaView 5400 Integrated-display Computers
6200V-DVICBL2M	DVI Cable, 2 m (6.5 ft)	
6200V-VGACBL2M	VGA Cable, 2 m (6.5 ft)	
6200V-USBCBL2M	USB Cable, 2 m (6.5 ft)	
6200V-DPHDMI4K	VersaView Accessory Display Port to HDMI	

Adapters

Cat. No.	Description	For Use With
6189V-DVIVGA	DVI-I to VGA Adapter	VersaView 5100 Monitors
6200V-DPVGA2	DisplayPort to VGA Adapter	VersaView 5200 Compact Non-display Computers VersaView 5200 Integrated-display Computers VersaView 5400 Compact Non-display Computers VersaView 5400 Integrated-display Computers
6200V-DPDVI2	DisplayPort to DVI Adapter	
6200V-MDP2HDMI4K	VersaView 5200 mDP to HDMI Adapter	6200T-RC, 6200T-RE
6200V-MDP2DP	VersaView 5200 mDP to DP Adapter	

Housing Kits

Cat. No.	Description	For Use With
6200V-DCCONN	DC Power Connector Housing Kit	VersaView 5100 Monitors VersaView 5200 Compact Non-display Computers VersaView 5200 Integrated-display Computers VersaView 5400 Compact Non-display Computers VersaView 5400 Integrated-display Computers
6200V-DCCONN2	Replacement DC terminal block	6200T-KB, 6200T-RC, 6200T-RE

Accessories

Cat. No.	Description	For Use With
6200V-PLUGS	Protective I/O port dust caps	6200T-NAK, 6200T-NS3x1K

Integrated Display Computers

The following tables list accessories for the 6181P integrated display computers.

Storage Drives

Cat. No.	Description	For Use With
6189V-CFSSD8GB	CompactFlash 8 GB solid-state drive	6181P (Series F)
6189V-CFSSD16GB	CompactFlash 16 GB solid-state drive	
6189V-6181TRAY	Empty 2.5" HDD Tray	
6189V-6181HDD100GB	Replacement 2.5-in. 100 GB HDD mounted in HDD Tray	
6189V-6181SSD32GB	Replacement 2.5-in. 32 GB SLC SSD mounted in SSD Tray	
6189V-6181SSD64GB	Replacement 2.5-in. 64 GB SLC SSD mounted in SSD Tray	
6189V-6181SSD256GB	Replacement 2.5-in. 256 GB MLC SSD mounted in SSD Tray	

Memory Modules

Cat No.	Description	For Use With
6189V-8GSODDR3	Replacement DDR3 Memory 2 x 4 GB SO-DIMM	6181P (Series F)
6189V-16GSODDR3	Upgrade DDR3 Memory 2 x 8 GB SO-DIMM	

Add-in Cards and Modules

Cat No.	Description	For Use With
6189V-PCINET	Ethernet PCI card, 10/100/1000Mbps	6181P (Series F)
6189V-EXTPCI2	PCIe Slot Expansion Kit: Contains extended back panel and three riser cards total: <ul style="list-style-type: none"> • 1 PCIe 4x and 1 PCI • 2 PCIe 4x • 2 PCI 	
6189V-PCIR	PCIe Slot Legacy Kit: Riser card for 1 PCI	

Power Supply

Cat. No.	Description	For Use With
6189V-PSU6181DC	Replacement DC Power Supply	6181P (Series F) ⁽¹⁾
6189V-PSU6181AC	Replacement AC Power Supply	6181P (Series F) ⁽²⁾

(1) Must only be used with DC units.

(2) Must only be used with AC units.

Protective Screen Covers

Cat. No.	Description	Quantity	For Use With
6189V-SCRNCOVER12	Protective Screen Cover	10	6181P/F, 6181P (Series F)
6189V-SCRNCOVER15			6181P/F, 6181P (Series F) ⁽¹⁾
6189V-SCRNCOVER17			6181P/F, 6181P (Series F)

(1) Excludes 16:9 wide screen models.

Mounting Hardware

Cat. No.	Description	For Use With
6189V-MCLPS3	14 Replacement Mounting Clips	6181P (Series F)
6189V-BOOKBRKT	Bookshelf Bracket for Non-Display Model	6181P Non-Display (Series F)

Cable

Cat. No.	Description	For Use With
6189V-DVICBL5	Digital video cable, 5 m (16.4 ft)	6181P (Series F)

Adapters

Cat. No.	Description	For Use With
6189V-DPDMI	Display Port to DVI-D Adapter	6181P (Series F)
6189V-DPVGA	Display Port to VGA Adapter	

Replacement Parts

Cat. No.	Description	For Use With
6189V-ODD	Replacement and Upgrade Kit - CD/DVD	6181P (Series F)
6189V-USBKEY	Key for front USB port	
6189V-ACCESSBOX6181	Replacement accessory box	

Hazardous Location Computers

The following tables list accessories for hazardous location computers.

Memory Modules

Cat. No.	Description	For Use With
6189X-16GDDR3	16 GB DDR3 memory	6181X – Series H
6189X-4GDDR2	4 GB DDR2 memory	6181X – Series F/G

Mounting Hardware

Cat. No.	Description	Quantity
6189X-MCLPS	Mounting clips	10

UV/IR Protection Accessory

Cat. No.	Description	Quantity
6189X-SUNSHIELD,	Sunshield accessory for 12-in resistive and PCAP display models	1

Storage Drives

Cat. No.	Description	For Use With
6189X-128GBSSD	128 GB solid-state drive	6181X – Series H
6189X-256GBSSD	256 GB solid-state drive	
6189V-CFSSD8GB	CompactFlash 8 GB solid-state drive	6181X – Series F/G
6189V-CFSSD16GB	CompactFlash 16 GB solid-state drive	

PCI/e Riser Card

Cat. No.	Description	Quantity
6189X-PCIRISER	PCI Riser card for use with 6181X PCs only	1

Non-display Computers

The following tables list accessories for the 6177R non-display computers.

Storage Drives

Cat. No.	Description	For Use With
6189V-35HDD500GB	3.5-in. 500 GB SATA hard disk drive	750R, 1450R (6177R Series C)
6189V-35HDDTRAY	Empty hard disk drive tray	
6189V-35HDD1TB	3.5-in 1 TB SATA hard disk drive	

Memory Modules

Cat. No.	Description	For Use With
6189V-4GDDR3	4 GB RAM upgrade, 2 x 2 GB DDR3	750R, 1450R (6177R Series C)
6189V-8GDDR3	8 GB RAM upgrade, 2 x 4 GB DDR3	
6189V-16GDDR3	16 GB RAM upgrade, 2 x 8 GB DDR3	

Add-in Cards and Modules

Cat No.	Description	For Use With
6189V-PCINET	Ethernet PCI card, 10/100/1000 Mbps	6177R
6189V-PCIBARMM	I/O card retention bracket	6177R Machine Mount
6189V-PCIBARRM	I/O card retention bracket	6177R Rack Mount

Mounting Hardware

Cat. No.	Description	For Use With
6189V-RACKSLIDES	Rackslides for mounting computer in rack cabinet	6177R Rack Mount

Cables

Cat. No.	Description	For Use With
6189V-DVIVGA	DVI-I to VGA adapter	6177R

Industrial Monitors

The following tables list accessories for the 6176M and 6186M industrial monitors.

Power Supply

Cat. No.	Description	For Use With
6189V-MPS3	AC-to-DC power adapter	6176M, 6186M

Protective Screen Covers

Cat. No.	Description	Quantity	For Use With
6189V-SCRNCOVER12	Protective screen cover	10	6186M-12
6189V-SCRNCOVER15			6176M-15, 6186M-15
6189V-SCRNCOVER17			6176M-17, 6186M-17

Mounting Hardware

Cat. No.	Description	Quantity	For Use With
6189V-MCLPS2	Mounting Clips	12	6176M
6189V-MCLPS3		14	6186M

Cables

Cat No.	Description	For Use With
6189V-DVICBL2	Digital video cable, 2 m (6.5 ft)	6176M, 6186M
6189V-DVICBL5	Digital video cable, 5 m (16.4 ft)	
6189V-TCHCBL2	Serial touch screen cable, 2 m (6.5 ft)	
6189V-VGACBL2	Analog VGA video cable, 1.8 m (6 ft)	
6189V-USBCBL2	USB touch screen cable, 1.8 m (6 ft)	

Operating System Upgrade

Cat No.	Description	For Use With
6189V-WIN10UPG	Windows 10 IoT Enterprise LTSB (64-bit) Upgrade License	6181P – Series F Only 6177R – Series C Only

Industrial Keyboards and Pointing Devices

The following table lists the keyboards and pointing devices that are available for the industrial computers.

Industrial Keyboards and Pointing Devices

Cat. No.	Description (Connection Port)	For Use With
6189V-HPMOUSE	Pointing device, SS ⁽¹⁾ (PS/2™)	PanelView Plus 6, PanelView Plus 7, PanelView 5000, 6181P, 6181X, 6177R, VersaView
6189V-HPMOUSEP	Panel-mount pointing device, SS (PS/2)	
6189V-HPMOUSEPU	Panel-mount pointing device, SS (USB)	
6189V-HPMOUSEU	Desktop mouse, SS (USB)	
6189V-KBDEPC1U	Desktop keyboard with pointing device, PC ⁽²⁾ (USB)	
6189V-KBDEPP1UC	Desktop keyboard with pointing device, PC (USB)	
6189V-KBDEPS1	Desktop keyboard with pointing device, SS (PS/2)	
6189V-KBDEPS1U	Desktop keyboard with pointing device, SS (USB)	
6189V-KBPEPS1	Panel-mount keyboard with pointing device, SS (PS/2)	
6189V-KBPEPS1U	Panel-mount keyboard with pointing device, SS (USB)	
6189V-MOUSEU	Fully sealed, waterproof optical mouse, PC (USB)	

(1) SS = stainless steel
 (2) PC = polycarbonate



Notes:

ThinManager Software

ThinManager® provides software solutions for automation networks that enable secure, centralized configuration and deployment of applications and content to every PC, thin client, mobile device and user. ThinManager increases safety and security through powerful visualization and authentication features allowing you to reduce your maintenance and downtime by simplifying the management of all devices and users.

You can also go mobile with ThinManager's built-in mobility solution, Relevance®—the only location-based mobile management platform that allows applications and content to be securely delivered to specific locations within your facility and nowhere else.

FactoryTalk HMI Software

FactoryTalk® View performance and visibility HMI software, including FactoryTalk View Machine Edition, FactoryTalk View Site Edition, FactoryTalk ViewPoint, and FactoryTalk View Studio are designed with a common look, feel, and navigation to help speed HMI development and training time.

Supporting the Rockwell Automation® Integrated Architecture® platform, FactoryTalk View software is part of the scalable and unified suite of monitoring and control solutions that are designed to span machine-level applications through supervisory-level HMI applications across a network. This suite of HMI software products offers you a common development environment, application reuse, and architecture to increase productivity, reduce operation costs, and improve quality.

Combining Rockwell Automation hardware with its software provides comprehensive application support from an industry leader. For a complete list of available HMI software, visit <http://www.rockwellautomation.com/rockwellsoftware>.

FactoryTalk View Machine Edition Software



FactoryTalk View Machine Edition (ME) software supports both open and embedded operator interface solutions for monitoring and controlling individual machines or small processes. This software features a consistent operator interface across multiple platforms, including Microsoft Windows 8.1, 7, XP, Server, and Embedded Compact solutions. FactoryTalk View ME software consists of a design and runtime environment.

FactoryTalk View Studio Software

FactoryTalk View Studio software is the design environment for creating and testing HMI applications, including graphic displays, trends, alarms, and real-time animation. Runtime files can be generated to run on a PanelView™ Plus terminal or industrial computer.

FactoryTalk View ME Station

FactoryTalk View ME Station is the runtime environment for HMI applications. FactoryTalk View ME Station is automatically installed and activated on PanelView Plus terminals. FactoryTalk View ME Station activation is required when running HMI applications on industrial computers.

FactoryTalk View ME software offers many advantages:

- Alarms to alert operators to conditions that require immediate action
- Security to restrict operator access to specific displays
- RecipePlus for machine or process recipe management
- Runtime language switching supports up to 20 languages per runtime application⁽¹⁾
- Global and predefined objects are time and memory savers
- RSLogix 5000® and Studio 5000 Logix Designer® process faceplates
- Ability to convert runtime application to design application
- Parameter passing to facilitate reuse of displays and design efficiency

FactoryTalk View Site Edition Software

FactoryTalk® View Site Edition (SE) is a supervisory-level HMI software for monitoring and controlling distributed-server/multi-user applications. It provides a comprehensive and accurate picture of operations, meeting the demands of multiple stakeholders including engineering, maintenance, operations, and production Information Technology (IT).

FactoryTalk View SE provides robust and reliable functionality in a single software package that scales from a stand-alone HMI system to a distributed visualization solution. As our customers have experienced over the past few years, FactoryTalk View SE enables you to take advantage of mobility, virtualization, and other new technologies, meeting HMI challenges in process, batch and discrete applications and delivering critical visibility when and where you need it.



FactoryTalk View SE applications are created and tested within the FactoryTalk View Studio design environment:

- Share data and seamless integration with other FactoryTalk enabled products. The FactoryTalk Services Platform provides common services such as security, alarming, and diagnostics across products.
- Optimize plant communication with FactoryTalk Live Data and premier connectivity to Rockwell Automation controllers.
- Access tag information directly in the controller, which eliminates the need to create HMI tags.
- Configure an application from anywhere on the network and make changes to a running system with a remote, multi-user configuration capability.
- Define graphic displays once and reference them throughout a distributed system.
- Provide an audit trail of operator and alarm information in a centralized log database.
- Customize the operator experience by using client-side VBA and the exposed graphics object model.
- Maximize system availability with online creation and editing of graphics and optional server redundancy.
- TrendPro, a new trending tool, helps operators to access real time data with built-in analysis tools. The tool showcases contextualized production data by pulling from a variety of sources that were once difficult to access: FactoryTalk View SE data logs, FactoryTalk Live Data and FactoryTalk Historian data. The latest release provides operators easy, ad-hoc, drag-and-drop capabilities that bring trends front and center.

(1) An application can support up to 40 languages, but only 20 languages are allowed in the runtime application.

- With new tag-extended properties, developers have direct access to tag descriptions, engineering units, and min/max settings from the controller. This leaves less room for duplication errors and streamlines the design process. Additionally, the new tag-extended properties enable simplified language switching. Instead of requiring a developer to program language strings within the HMI, translated content can now be directly accessed from the controller, further saving design time.
- The new recipe manager offers an easy way to download and upload multiple machine parameters at once. The RecipePro+ editor includes a user-friendly interface to create and edit recipe files, and allows for importing and exporting files. For Rockwell Software RSView® 32 users looking to modernize their HMI SCADA, RecipePro+ will greatly streamline migration to FactoryTalk View SE software

FactoryTalk View Studio Software

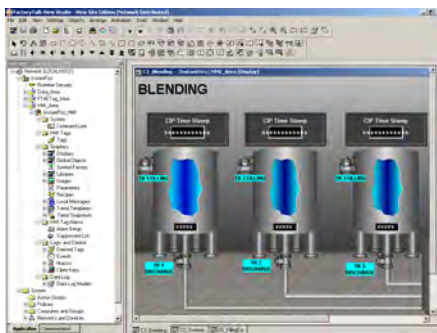

FactoryTalk View Machine Edition and FactoryTalk View Site Edition share a common design environment called FactoryTalk View Studio for creating applications. The ability to edit and reuse projects in FactoryTalk View Studio improves portability between embedded machine and supervisory HMI systems.

With FactoryTalk View software, all products in the suite are built on the same integrated, scalable architecture. Application developers can import entire machine-level applications into supervisory-level applications or drag individual components and drop them right into supervisory projects, which saves development time and reduces engineering and training costs.

Plus, you can protect your current HMI investments by importing PanelBuilder® 32 (PanelView™) applications into FactoryTalk View ME software and RSView® 32 applications into FactoryTalk View SE software.

With FactoryTalk View Studio software, you can do the following:

- Configure one operator station or an entire distributed application from one location.
- Access tags from OPC servers throughout the system via a tag browser that presents direct controller tags and HMI tags in a logical hierarchy.
- Remotely configure RSLinx® and FactoryTalk View SE servers.
- Create displays by using a full-featured graphics editor.
- Define display test in multiple languages, allowing operators to switch the language at runtime.
- Use pre-engineered faceplates to interface with the process control functions in the Logix controllers.

FactoryTalk ViewPoint Software



An add-on to FactoryTalk View SE software and PanelView Plus 6 or 7 terminals, FactoryTalk ViewPoint software provides on-demand access to important information about your plant or process from a web browser. Plant managers, supervisors, OEMs, system integrators, and other key stakeholders can now access, monitor, and interact with plant floor operations from virtually any location. The thin-client configuration means no client software to install and maintain, which lowers the total cost of ownership:

- Fully scalable, animated web applications viewable in the office, at home, or on the road.
- Gives managers, OEMs, and system integrators read and write capability to both view and control real-time plant floor operations by logging in via an internet browser.
- Gain fast access to real-time information by using a standard web browser.
- Supports multiple browsers and client devices for increased flexibility.
- Lets FactoryTalk View projects be web-enabled without requiring application changes.

- Monitor and control HMI applications, perform diagnostics, and provide remote support without having to be at customer sites.
- As part of a continued focus on the mobile workforce, [FactoryTalk ViewPoint mobile HMI software](#) offers yet another layer of improved productivity in version 9.0. Operators are now able to acknowledge or shelve an alarm notification directly from a mobile device.

Software Comparison

Technology

Customer Requirements	FactoryTalk View Site Edition (SE)	FactoryTalk View Machine Edition (ME)
Operating systems (32-bit)	<ul style="list-style-type: none"> • Windows 8.1 Professional • Windows 8.1 Enterprise • Windows 8 Professional • Windows 8 Enterprise • Windows 7 Professional or Professional SP1 both supported • Windows Server 2008 Standard SP2 and 2008 R2 Standard SP2 supported <ul style="list-style-type: none"> • Windows XP Professional SP3 • Windows Server 2003 R2 Standard SP2 	
Operating systems (64-bit)	<ul style="list-style-type: none"> • Windows 10 Professional • Windows 10 Enterprise • Windows 8.1 Professional • Windows 8.1 Enterprise • Windows 8 Professional • Windows 8 Enterprise • Windows 7 Professional SP1 • Windows 7 Enterprise SP1 • Windows 7 Ultimate SP1 • Windows Server 2016 • Windows Server 2012 Standard • Windows Server 2012 R2 Standard • Windows Server 2008 Standard SP2 • Windows Server 2008 R2 Enterprise SP1 or 2008 Server R2 Standard SP1 • XP Professional 32-bit SP3 supported only, not 64 bit • Windows Server 2008 R2 Standard SP1 	
Embedded platforms		x
Windows domain security	x	x
OPC/ActiveX	x	x
FactoryTalk enabled	x	x
Server-side VBA		
Client-side VBA	x	

Architecture

Customer Requirements	FactoryTalk View Site Edition	FactoryTalk View Machine Edition
Primary application	Supervisory level: single-station or multiple-server, multiple-client	Machine level: single-station
Tag-based HMI	x	x
Direct referencing	x	x
	Network (Distributed)	Local

Architecture

Customer Requirements	FactoryTalk View Site Edition		FactoryTalk View Machine Edition
Max number of servers/clients	10/50		
FactoryTalk ViewPoint	x	x	x ⁽¹⁾
Thin clients (terminal services)	x		
Multi-user development	x		
Remote configuration at runtime	x		
Redundancy - data server	x		
Redundancy - HMI server	x		

(1) Supported only on PanelView™ Plus 6 and PanelView™ Plus 7 terminals.

Features

Customer Requirements	FactoryTalk View Site Edition	FactoryTalk View Machine Edition
Animation ⁽¹⁾	And touch	No touch animation
Alarms	<ul style="list-style-type: none"> FactoryTalk Alarms and Events HMI alarms Digital and analog Defined alarm severities Alarm log 	<ul style="list-style-type: none"> Tag-based (from controller) Alarm log
Data logging	<ul style="list-style-type: none"> 20 data log models per project Each with up to 10,000 tags Log to ODBC or proprietary database 	<ul style="list-style-type: none"> 1 data log model per project With up to 100 tags 1,000 K records max Export to dbf
Trend version	<ul style="list-style-type: none"> TrendX 4.0 TrendPro 	<ul style="list-style-type: none"> TrendX 4.0 subset
Security	<ul style="list-style-type: none"> Security assigned to tags, graphic displays, macros, commands, OLE objects Local or Windows security 	<ul style="list-style-type: none"> Display-based Local or Windows security
Other features	<ul style="list-style-type: none"> Test run macros Derived tags Event detector 	<ul style="list-style-type: none"> Test run macros Derived tags S/CTest RunMacrosDerived Tags
Price model	<ul style="list-style-type: none"> Display-based pricing Multiple levels 	<ul style="list-style-type: none"> Included with PanelView Plus 6 or display-based pricing Multiple levels for FactoryTalk View ME Station

(1) Includes visibility, color, fill, horizontal and vertical position, width, height, rotation, horizontal and vertical slider, and more.

Studio 5000 View Designer HMI Software

Studio 5000 View Designer® is the development environment for PanelView 5000 operator interface terminals, and is included as part of the Studio 5000 Automation Engineering and Design Environment™. This integrated environment allows engineers to enter configuration information only once and leverage it across the entire automation design system. The integration of the PanelView 5000 with Studio 5000® can help you build modern applications more easily and make data-driven decisions faster.

Using Studio 5000 View Designer with ControlLogix® controllers provides enhanced integration with features such as:

- Logix-based alarms that are automatically available on the PanelView 5000 platform. No alarm configuration is necessary in the HMI application.
- Pre-configured system banner, alarm summary, and diagnostic displays that reduce design time and offer a consistent user experience.
- High-speed HMI buttons that provide quick response and feedback for machine-jogging applications.
- Logix tag extended-property support that helps to develop richer content.
- An intuitive View Designer environment that reduces configuration time.
- Scalable vector graphics that automatically adjust objects and screens to any terminal size.
- A searchable toolbox of graphic elements with built-in animations that simplify configuration.
- Create custom, re-usable add-on graphics to more efficiently build your applications.
- Multi-language support with a language switching feature enables users to switch between languages on the PanelView 5500 to support global user needs.

Operating System and Service Pack Compatibility

This version of the Studio 5000 View Designer application has been tested on the following operating systems:

- Microsoft® Windows® 7 Professional (64-bit) with Service Pack 1
- Microsoft Windows Server 2008 R2 Standard Edition with Service Pack 1
- Microsoft Windows 8.1 Professional (64-bit)
- Windows 10 Professional
- Microsoft Windows Server 2012 Standard Edition (server version of Windows 8)
- Windows Server 2016 Standard Edition.

Note: While the Windows 8 and Windows 8.1 operating systems run on many touch-enabled devices, various features of the View Designer application may not be touch-enabled. Most functions are expected to work with touch, but the software has only been tested with a keyboard and mouse.

This version of the Studio 5000 View Designer application is expected to operate correctly on all other editions and service packs of the following operating systems, but has not been tested:

- Microsoft Windows 7
- Microsoft Windows Server 2008 R2
- Microsoft Windows 8
- Microsoft Windows Server 2012
- Microsoft Windows Server 2012 R2
- Windows Server 2016
- Other versions of Microsoft Windows 10

Software Selection

The tables in this section provide catalog numbers and descriptions for the available HMI software.

ThinManager Software

Please visit our software portal at commerce.rockwellautomation.com to select and order your tailored ThinManager software license.

FactoryTalk HMI Software

To choose your preferred language, replace the xx in the catalog number with EN for English, DE for German, FR for French, JP for Japanese, or ZH for Chinese.

FactoryTalk View Machine Edition (ME) Software

Cat. No.	Description
9701-VWSTMxxE	FactoryTalk View Studio for Machine Edition - Configuration software to develop and test machine level HMI applications. FactoryTalk View Machine Edition includes RSLinx® Enterprise and KEPServer Enterprise software.

To choose your preferred language, replace the xx in the catalog number with EN for English, DE for German, FR for French, JP for Japanese, or ZH for Chinese.

FactoryTalk View Machine Edition (ME) Station

Cat. No.	Description ⁽¹⁾ ⁽²⁾
9701-VWMR015AxxE	FactoryTalk View ME Station runtime 15 displays
9701-VWMR030AxxE	FactoryTalk View ME Station runtime 30 displays
9701-VWMR075AxxE	FactoryTalk View ME Station runtime 75 displays
9701-VWMR250AxxE	FactoryTalk View ME Station runtime 250 displays RS-232 operating cable, 9-pin D-shell to 8-pin Mini DIN

(1) FactoryTalk View Machine Edition Station is the Runtime environment where FactoryTalk View ME projects created with FactoryTalk View Studio software are run on any computer with a Windows operating system.

(2) FactoryTalk View ME Station Runtime is included with all PanelView Plus 6 or PanelView Plus 7 terminals.

To choose your preferred language, replace the xx in the catalog number with EN for English, DE for German, FR for French, JP for Japanese, or ZH for Chinese.

FactoryTalk View Site Edition (SE) Software

Cat. No.	Description ⁽¹⁾
9701-VWSTxxE	FactoryTalk View Studio for FactoryTalk View Enterprise- configuration software to develop and test machine level and supervisory level HMI applications
9701-VWSCWAxxE	FactoryTalk View SE Client - software to view and interact with FactoryTalk View SE Servers ⁽²⁾
9701-VWSCRAxxE	FactoryTalk View SE View Client - provides read-only capabilities
9701-VWSB015AxxE	FactoryTalk View SE Station 15 display
9701-VWSB025AxxE	FactoryTalk View SE Station 25 display
9701-VWSB100AxxE	FactoryTalk View SE Station 100 display
9701-VWSB250AxxE	FactoryTalk View SE Station 250 display
9701-VWSB000AxxE	FactoryTalk View SE Station unlimited display

FactoryTalk View Site Edition (SE) Software

Cat. No.	Description ⁽¹⁾
9701-VWSS025LxxE	FactoryTalk View SE Server 25 display with RSLinx® Enterprise
9701-VWSS100LxxE	FactoryTalk View SE Server 100 display with RSLinx Enterprise
9701-VWSS250LxxE	FactoryTalk View SE Server 250 display with RSLinx Enterprise
9701-VWSS000LxxE	FactoryTalk View SE Server unlimited display with RSLinx Enterprise

- (1) FactoryTalk View Station and FactoryTalk View SE Server include RSLinx Enterprise and RSLinx Classic software, version 3.70.
 (2) FactoryTalk View SE Server stores HMI project components and serves to clients, for example, graphic displays.

FactoryTalk ViewPoint Software

Cat. No. ⁽¹⁾	Description ⁽²⁾
9522-VWP01RENE	FactoryTalk ViewPoint 1-client system
9522-VWP03RENE	FactoryTalk ViewPoint 3-client system
9522-VWP05RENE	FactoryTalk ViewPoint 5-client system
9522-VWP10RENE	FactoryTalk ViewPoint 10-client system
9522-VWP25RENE	FactoryTalk ViewPoint 25-client system
9522-VWP50RENE	FactoryTalk ViewPoint 50-client system

- (1) Order any of these catalog numbers to use FactoryTalk ViewPoint software with FactoryTalk View SE network or local applications.
 (2) FactoryTalk ViewPoint server and one client access license is included with the purchase of a PanelView Plus 6 or PanelView Plus 7 terminal. No other catalog numbers are required to use FactoryTalk ViewPoint software with PanelView Plus 6 or PanelView Plus 7 terminals.

Third-party Connectivity

Cat. No.	Description
9301-OPCSRVE	KEPServer Enterprise FactoryTalk View Site Edition and FactoryTalk View Machine Edition

Studio 5000 View Designer HMI Software

The table describes the available Studio 5000 View Designer software. View Designer software is included as part of the following Studio 5000 software catalog numbers.

Studio 5000 HMI Software

Cat. No.	Description
9324-RLD200ENE	ESD - Studio 5000 Mini, English
9324-RLD200ENM	MEDIA - Studio 5000 Mini, English
9324-RLD250ENE	ESD - Studio 5000 Lite Edition, English
9324-RLD250ENM	MEDIA - Studio 5000 Lite Edition, English
9324-RLD300ENE	ESD - Studio 5000 Standard, English
9324-RLD300ENM	MEDIA - Studio 5000 Standard, English
9324-RLD600ENE	ESD - Studio 5000 Full Edition, English
9324-RLD600ENM	MEDIA - Studio 5000 Full Edition, English
9324-RLD700XENE	ESD - Studio 5000 Professional Edition, English
9324-RLD700XENM	MEDIA - Studio 5000 Professional Edition, English

Notes:

Additional Resources

These documents contain additional information concerning related products from Rockwell Automation.

Resource	Description
PanelView 5310 Terminals Specifications Technical Data, publication 2713P-TD001	Provides technical specifications, certifications, and environmental specifications for the PanelView 5310 terminals.
PanelView 5510 Terminals Specifications Technical Data, publication 2715P-TD001	Provides technical specifications, certifications, and environmental specifications for the PanelView 5510 terminals.
ArmorView Plus 7 Installation Instructions, publication 2711P-IN013	Provides instructions on how to install and configure the ArmorView Plus 7 components.
PanelView Plus 7 Performance Terminals Technical Data, publication 2711P-TD009	Provides technical specifications, certifications, and environmental specifications for the PanelView Plus 7 Performance terminals.
PanelView Plus 7 Standard Terminals Technical Data, publication 2711P-TD008	Provides technical specifications, certifications, and environmental specifications for the PanelView Plus 7 Standard terminals.
PanelView Plus 6 Specifications Technical Data, publication 2711P-TD005	Provides technical specifications, certifications, and environmental specifications for the PanelView Plus 6 terminals.
MobileView Tethered Operator Terminal Technical Data, publication 2711T-TD001	Provides technical specifications, certifications, and environmental specifications for the MobileView tethered operator terminals.
PanelView 800 Terminals Technical Data, publication 2711R-TD001	Provides technical specifications, certifications, and environmental specifications for the PanelView 800 terminals.
Industrial Computers and Monitors Specifications Technical Data, publication IC-TD001	Provides technical specifications, certifications, and environmental specifications for the industrial computers and monitors.
PanelView Plus 6 Terminals to PanelView Plus 7 Terminals Catalog Number Conversions Migration Guide, publication 2711P-AP004	Provides information on how to convert PanelView Plus 6 terminals to the new generation terminals: PanelView Plus 7 Performance terminals and PanelView Plus 7 Standard terminals.
Industrial Automation Wiring and Grounding Guidelines, publication 1770-4.1	Provides general guidelines for installing a Rockwell Automation industrial system.
Product Certifications website, rok.auto/certifications .	Provides declarations of conformity, certificates, and other certification details.

You can view or download publications at rok.auto/literature.

Rockwell Automation Support

Use these resources to access support information.

Technical Support Center	Find help with how-to videos, FAQs, chat, user forums, and product notification updates.	rok.auto/support
Knowledgebase	Access Knowledgebase articles.	rok.auto/knowledgebase
Local Technical Support Phone Numbers	Locate the telephone number for your country.	rok.auto/phonesupport
Literature Library	Find installation instructions, manuals, brochures, and technical data publications.	rok.auto/literature
Product Compatibility and Download Center (PCDC)	Download firmware, associated files (such as AOP, EDS, and DTM), and access product release notes.	rok.auto/pcdc

Documentation Feedback

Your comments help us serve your documentation needs better. If you have any suggestions on how to improve our content, complete the form at rok.auto/docfeedback.

Allen-Bradley, ArmorView, CompactLogix, Connected Components Workbench, ControlLogix, DH+, FactoryTalk, Integrated Architecture, LISTEN. THINK. SOLVE., Micro800, MicroLogix, MobileView, PLC-5, PanelBuilder, PanelView, RSLinx, RSLogix 5000, RSVIEW, Relevance, Rockwell Automation, Rockwell Software, SLC, Studio 5000, Studio 5000 Logix Designer, Studio 5000 View Designer, ThinManager, and VersaView are trademarks of Rockwell Automation, Inc.

CIP and EtherNet/IP are trademarks of ODVA, Inc.





Microsoft and Windows are trademarks of Microsoft Corporation.

SD and SDHC are trademarks of SD-3C LLC.

Trademarks not belonging to Rockwell Automation are property of their respective companies.

Rockwell Automation maintains current product environmental compliance information on its website at rok.auto/pec.

Rockwell Otomasyon Ticaret A.Ş. Kar Plaza İş Merkezi E Blok Kat:6 34752, İçerenköy, İstanbul, Tel: +90 (216) 5698400 EEE Yönetmeliğine Uygundur

Connect with us.    



rockwellautomation.com ————— expanding **human possibility**[™]

AMERICAS: Rockwell Automation, 1201 South Second Street, Milwaukee, WI 53204-2496 USA, Tel: (1) 414.382.2000, Fax: (1) 414.382.4444

EUROPE/MIDDLE EAST/AFRICA: Rockwell Automation NV, Pegasus Park, De Kleetlaan 12a, 1831 Diegem, Belgium, Tel: (32) 2 663 0600, Fax: (32) 2 663 0640

ASIA PACIFIC: Rockwell Automation, Level 14, Core F, Cyberport 3, 100 Cyberport Road, Hong Kong, Tel: (852) 2887 4788, Fax: (852) 2508 1846