

1606-XLSDNET4 24V, 3.8A; Single Phase Input

1606-XLSDNET4

24V, 3.8A Single Phase Input

POWER SUPPLY

- Ultra-small size
- Extra-low inrush current
- Active power factor correction
- Wide range AC/DC input; auto select input
- Superior reserve power (can support 150% rated power for five seconds)
- Superior efficiency and temperature rating
- DC-OK and overload LED



1. GENERAL DESCRIPTION

The 1606-XLSDNET4 power supply is a derivative of the Dimension XLS family, which is specially designed to meet the DeviceNet[®] requirement. The 1606-XLSDNET4 exists beside the 1606-XLSDNET8, which is the right choice to supply networks with the thick cable.

The specialties of DeviceNet[®] power supplies are:

- The nominal and overload currents are sized for the ratings of the DeviceNet[®] cables.
- Large load capacitors can be charged in a very short period of time.
- After turn on, the output voltage increases according to the DeviceNet[®] timing specification.
- The upper level of the output level is limited to protect the network.







The most outstanding features are a high efficiency, compact size, wide-range input voltage, a very low inrush surge and a DC-ok contact. High immunity to transients and power surges and a low electromagnetic emission makes usage in nearly every environment possible.

Unique quick-connect spring-clamp terminals allow a safe and fast installation. A large international approval package makes this unit suitable for nearly every situation.

2. SPECIFICATION QUICK REFERENCE

Output voltage	DC 24V	
Adjustment range	fixed	not adjustable
Output current	3.8A	
Output power	91.2W	continuous, 24V
Output ripple	< 50mVpp	20Hz to 20MHz
Input voltage	AC 100-240V	+10/-15%
Line frequency	50-60Hz	±6%
AC Input current	0.85 / 0.48A	at 120 / 230Vac
Power factor	0.98 / 0.90	at 120 / 230Vac
AC Inrush current	typ. 9 / 11A peak	at 120 / 230Vac
DC Input voltage	DC 110-300V	±20%
DC Input current	0.91 / 0.33A	at 110 / 300Vdc
Efficiency	91.4 / 92.0%	at 120 / 230Vac
Losses	8.6 / 7.9W	at 120 / 230Vac
Temperature range	-25°C to +70°C	operational
Derating	2W/°C	+60 to +70°C
Hold-up time	typ. 44 / 85ms	at 120 / 230Vac
Dimensions	40x124x117mm	WxHxD

3. AGENCY APPROVALS

 IND. CONT. EQ. UL 508	 UL 60950-1
 Class I Div 2	
 EMC, LVD	

4. RELATED PRODUCTS

1606-XLSDNET8	8 AMP DeviceNet Power Supply
1606-XLB	Wall mount bracket
1606-XLSRED	Redundancy Module
1606-XLBUFFER	Buffer unit

Rockwell Automation

1606-XLSDNET4 24V, 3.8A; Single Phase Input

INDEX	PAGE	INDEX	PAGE
1. General Description	1	19. Safety	12
2. Specification Quick reference	1	20. Dielectric Strength	12
3. Agency Approvals	1	21. Approvals	13
4. Related Products	1	22. Fulfilled Standards	13
5. AC-Input	3	23. Used Substances	13
6. Input Inrush Current	4	24. Physical Dimensions and Weight	14
7. DC-Input	4	25. Installation and Operation Instructions	14
8. Output	5	26. Accessories	15
9. Hold-up Time	6	27. Application Notes	16
10. DC-OK Relay Contact	6	27.1. Peak Current Capability	16
11. Efficiency and Power Losses	7	27.2. Back-feeding Loads	16
12. Functional Diagram	8	27.3. Parallel and Serial Use	16
13. Product Face label	8	27.4. Output Circuit Breakers	17
14. Terminals and Wiring	9	27.5. External Input Protection	17
15. Reliability	9	27.6. Inductive and Capacitive Loads	18
16. EMC	10	27.7. Operation on Two Phases	18
17. Environment	11	27.8. Use in a Tightly Sealed Enclosure	18
18. Protection Features	12	27.9. Mounting Orientations	19

INTENDED USE

Those responsible for the application and use of the products must satisfy themselves that all necessary steps have been taken to assure that each application and use meets all performance and safety requirements, including and applicable laws, regulation , codes, and standards.

TERMINOLOGY AND ABBREVIATIONS

PE and \oplus symbol	PE is the abbreviation for Protective Earth and has the same meaning as the symbol \oplus .
Earth, Ground	This document uses the term “earth” which is the same as the U.S. term “ground”.
T.b.d.	To be defined, value or description will follow later.
AC 230V	A figure displayed with the AC or DC before the value represents a nominal voltage with standard tolerances (usually $\pm 20\%$) included. E.g.: DC 12V describes a 12V battery disregarding whether it is full (13.7V) or flat (10V) As long as not otherwise stated, AC 100V and AC 230V parameters are valid at 50Hz and AC 120V parameters are valid at 60Hz mains frequency.
230Vac	A figure with the unit (Vac) at the end is a momentary figure without any additional tolerances included.
PELV	Protective Extra Low Voltage
SELV	Safety Extra Low Voltage

DISCLAIMER

The information presented in this document is believed to be accurate and reliable and may change without notice.

1606- XLSDNET4 24V, 3.8A; Single Phase Input

5. AC-INPUT

AC input	nom.	AC 100-240V	wide-range input, see Fig. 5-1
AC input range	min.	85-264Vac	continuous operation
	min.	60-85Vac	full power for 200ms, no damage between 0 and 85Vac
	min.	264-300Vac	< 500ms
Input frequency	nom.	50 – 60Hz	±6%
Turn-on voltage	typ.	82Vac	steady-state value, see Fig. 5-1
Shut-down voltage	typ.	78Vac	steady-state value, see Fig. 5-1

		AC 100V	AC 120V	AC 230V	
Input current	typ.	1.02A	0.85A	0.48A	at 24V, 3.8A, see Fig. 5-3
Power factor *	typ.	0.99	0.98	0.90	at 24V, 3.8A, see Fig. 5-4
Crest factor **	typ.	1.48	1.55	1.71	at 24V, 3.8A
Start-up delay	typ.	120ms	110ms	85ms	see Fig. 5-2
Rise time	typ.	18ms	18ms	18ms	0mF, 24V, 3.8A, see Fig. 5-2
	typ.	38ms	38ms	38ms	5mF, 24V, 3.8A, see Fig. 5-2
Turn-on overshoot	max.	100mV	100mV	100mV	see Fig. 5-2

* The power factor is the ratio of the true (or real) power to the apparent power in an AC circuit.

** The crest factor is the mathematical ratio of the peak value to RMS value of the input current waveform.

Fig. 5-1 Input voltage range

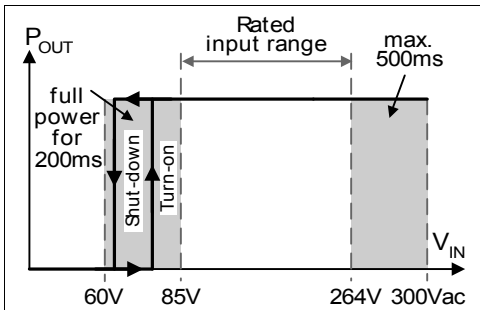

Fig. 5-2 Turn-on behavior, definitions

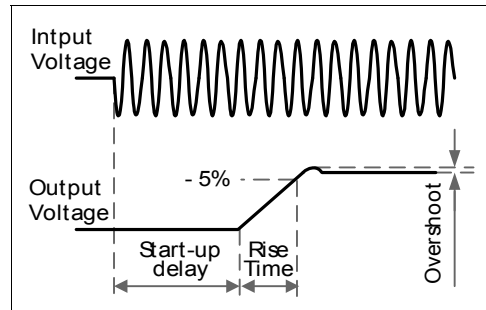

Fig. 5-3 Input current vs. output load at 24V

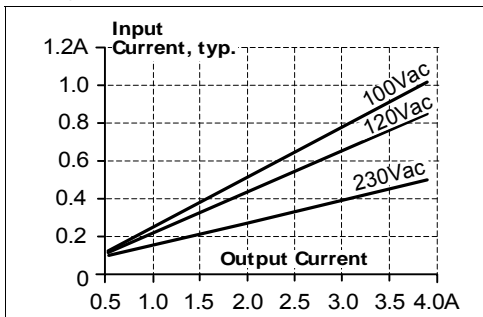
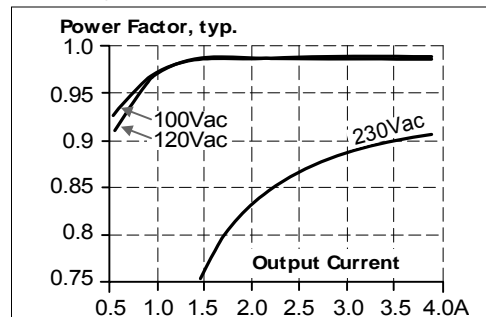

Fig. 5-4 Power factor vs. output load



1606- XLSDNET4 24V, 3.8A; Single Phase Input

6. INPUT INRUSH CURRENT

An active inrush limitation circuitry limits the input inrush current after turn-on of the input voltage and after short input voltage interruptions.

The charging current into EMI suppression capacitors is disregarded in the first milliseconds after switch-on.

		AC 100V	AC 120V	AC 230V	
Inrush current	max.	15A _{peak}	15A _{peak}	15A _{peak}	-25°C to +70°C
	typ.	8A _{peak}	9A _{peak}	11A _{peak}	-25°C to +70°C
Inrush energy	max.	1A ² s	1A ² s	1A ² s	-25°C to +70°C

Fig. 6-1 Input inrush current, typical behavior

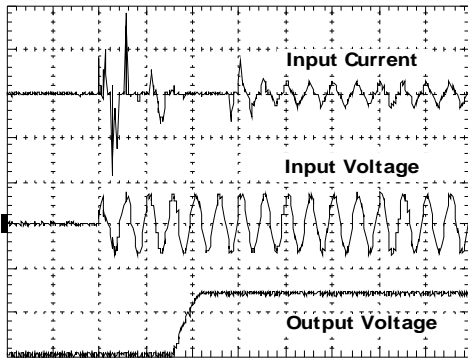

Input: 230Vac
 Output: 24V, 3.8A
 Ambient: 25°C
 Upper curve: Input current 5A / DIV
 Medium curve: Input voltage 500V / DIV
 Lower curve: Output voltage 20V / DIV
 Time basis: 40ms / DIV

7. DC-INPUT

DC input	nom.	DC 110-300V	
DC input range	min.	88-375Vdc	continuous operation
DC input current	typ.	2.37A / 0.87A	110Vdc / 300Vdc, 24V, 10A
Turn-on voltage	typ.	80Vdc	steady state value
Shut-down voltage	typ.	55Vdc	steady state value

Fig. 7-1 Wiring for DC Input

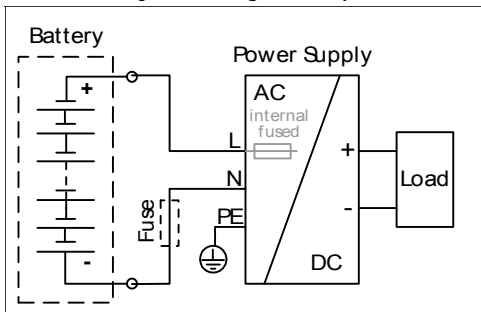

Instructions for DC use:

- Use a battery or similar DC source.
- Connect +pole to L and -pole to N.
- Connect the PE terminal to a earth wire or to the machine ground.

When the -pole of the battery is not connected to earth, use an appropriate fuse to protect the N terminal.

1606- XLSDNET4 24V, 3.8A; Single Phase Input

8. OUTPUT

Output voltage	nom.	24V	
Adjustment range	min.	fixed	Not adjustable
Line regulation	max.	20mV	85 to 264Vac
Load regulation	max.	70mV	static value, 0A → 3.8A → 0A
Ripple and noise voltage	max.	50mVpp	20Hz to 20MHz, 50Ohm
Output capacitance	typ.	3 500μF	
Output current	nom.	3.8A	see Error! Reference source not found.
		5.7A	for typ. 200ms to charge network capacitors (= Power-Boost)
Output power	nom.	91.2W	continuous
Short-circuit current	min.	4.0A	load impedance 200mOhm, see Error! Reference source not found.
	max.	7.0A	load impedance 200mOhm, see Error! Reference source not found.

Peak current capability (up to several ms)

The power supply can deliver a peak current which is higher than the specified short term current. This helps to start current demanding loads or to safely operate subsequent circuit breakers.

The extra current is supplied by the output capacitors inside the power supply. During this event, the capacitors will be discharged and causes a voltage dip on the output. Detailed curves can be found in chapter 27.1.

Peak current voltage dips	typ.	from 24V to 21.5V	at 7.6A for 20ms
	typ.	from 24V to 20.5V	at 15A for 2ms
	typ.	from 24V to 17.5V	at 15A for 5ms

Fig. 8-1 Output voltage vs. output current, typ.

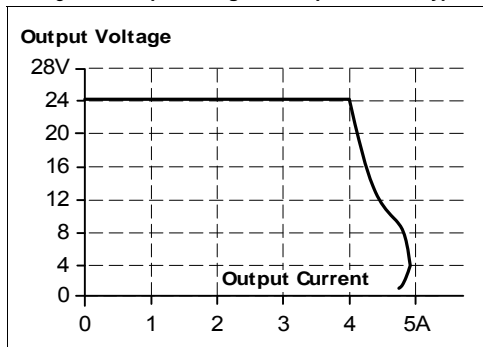

The Power-Boost is available as soon as power comes on and immediately after the end of an output short circuit.

Fig. 8-2 Power-Boost after input turn-on

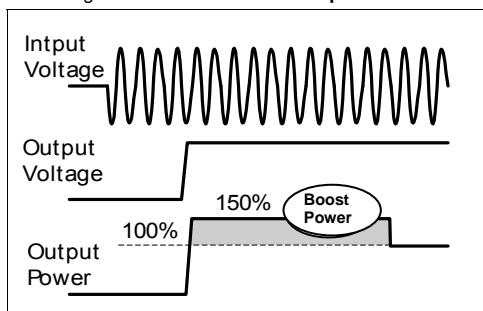
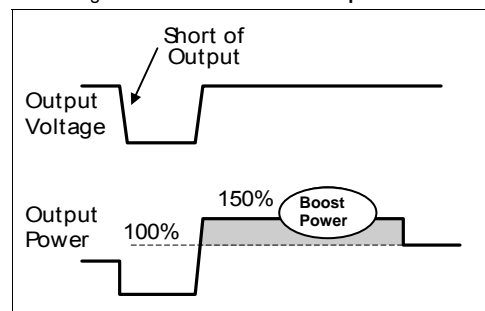

Fig. 8-3 Power-Boost after output short



Rockwell Automation

1606- XLSDNET4 24V, 3.8A; Single Phase Input

9. HOLD-UP TIME

		AC 100V	AC 120V	AC 230V	
Hold-up Time	typ.	44ms	44ms	85ms	3.8A, 24V, see Fig. 9-1
	typ.	87ms	87ms	167ms	1.9A, 24V, see Fig. 9-1

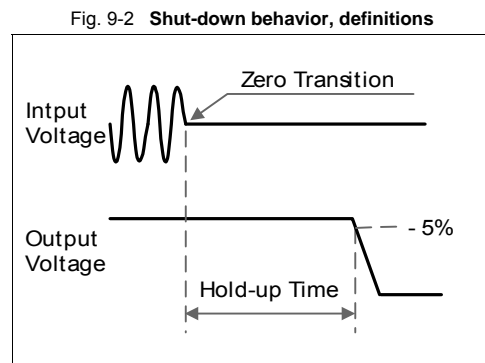
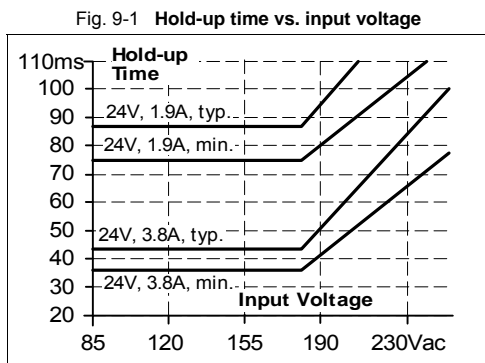

Note: At no load, the hold-up time can be up to one minute. The green DC-ok lamp is on during this time.

10. DC-OK RELAY CONTACT

This feature monitors the output voltage, which is produced by the power supply itself. It is independent of a back-fed voltage from a unit which is connected in parallel to the power supply output.

Contact closes	As soon as the output voltage reaches the adjusted output voltage.		
Contact opens	As soon as the output voltage dips more than 10% below the adjusted output voltage. Short dips will be extended to a signal length of 250ms. Dips shorter than 1ms will be ignored.		
Contact re-closes	As soon as the output voltage exceeds 90% of the adjusted voltage.		
Contact ratings	max	60Vdc 0.3A, 30Vdc 1A, 30Vac 0.5A	resistive load
	min	1mA at 5Vdc	min. permissible load
Isolation voltage	See dielectric strength table in section 20		

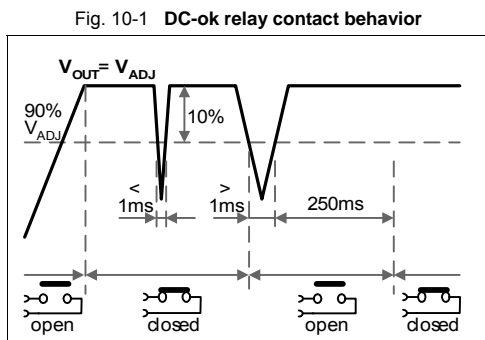

Note:

The DC-ok feature requires that the output voltage reaches the nominal (=adjusted) level after turn-on in order to function according to specification. If this level cannot be achieved, the overload lamp will be on and the DC-ok contact will be open. The overload signal will only shut off as soon as the adjusted voltage is reached. This is an important condition to consider particularly, if the load is a battery, the power supply is used in parallel or the power supply is used for N+1 redundant systems.

1606- XLSDNET4 24V, 3.8A; Single Phase Input

11. EFFICIENCY AND POWER LOSSES

		AC 100V	AC 120V	AC 230V	
Efficiency	typ.	90.4%	91.4%	92.0%	3.8A, 24V
Power losses	typ.	9.7W	8.6W	7.9W	3.8A, 24V
	typ.	3.7W	3.8W	4.3W	0A, 24V

Fig. 11-1 Efficiency vs. output current at 24V

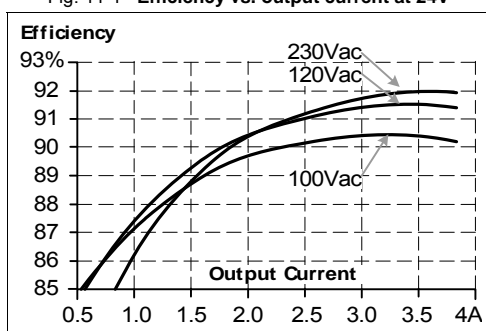

Fig. 11-2 Losses vs. output current at 24V

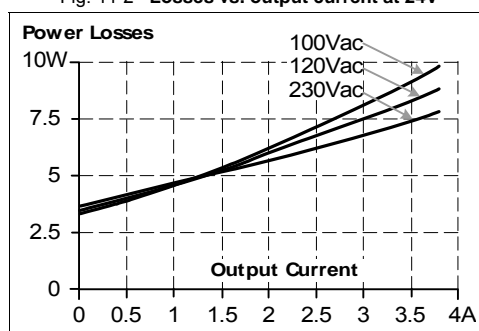

Fig. 11-3 Efficiency vs. input voltage, 24V, 3.8A

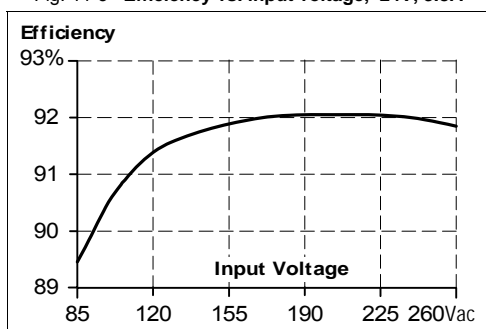
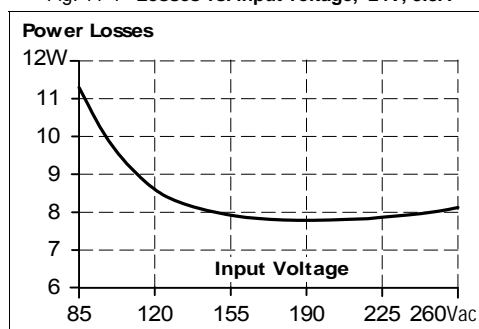
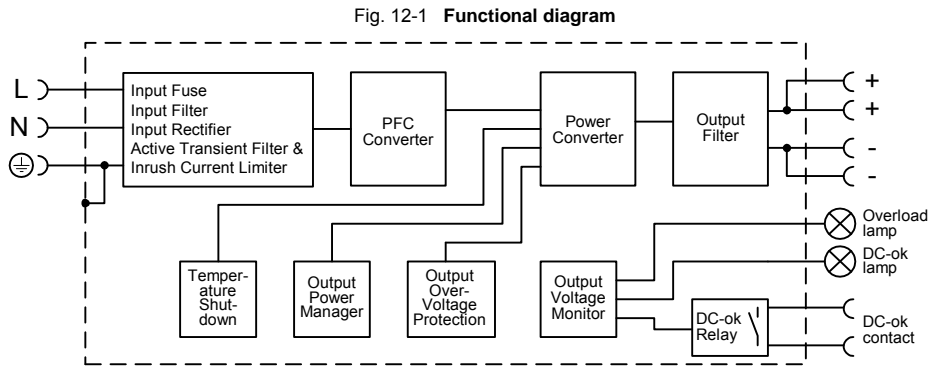

Fig. 11-4 Losses vs. input voltage, 24V, 3.8A



1606- XLSDNET4 24V, 3.8A; Single Phase Input

12. FUNCTIONAL DIAGRAM



13. PRODUCT FACE LABEL

Fig. 13-1 Front side

Output Terminals

Quick-connect spring-clamp terminals, no tools required

- + Positive output
- Negative (return) output
Dual pins per pole
- DC ok Relay contact (NO-contact)

Input Terminals

Quick-connect spring-clamp terminals, no tools required

- N ... Neutral input
- L ... Line (hot) input
- ⊕ ... PE (Protective Earth) input

See chapter 14 "Terminals and Wiring" to choose appropriate wire gauges

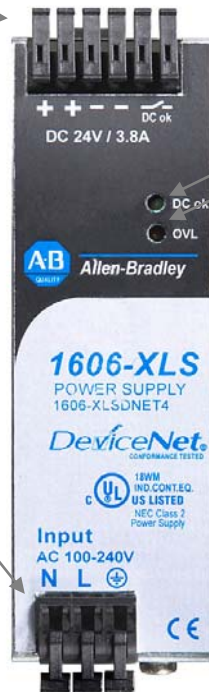

DC-ok lamp (green)
Overload lamp (red)

	Overload LED	DC-ok LED	DC-ok LED
Normal mode	OFF	ON	Closed
Power-Boost Mode	OFF	ON	Closed
Overload ($V_{OUT} < 90\%$)	ON	OFF	Open
Short-circuit ($V_{OUT} = \text{ca. } 0V$)	ON	OFF	Open
Over-temperature	Intermitted	OFF	Open
No input power	OFF	OFF	Open

DC-ok lamp and DC-ok contact function synchronized

1606- XLSDNET4 24V, 3.8A; Single Phase Input

14. TERMINALS AND WIRING

Type	Bi-stable, quick-connect spring clamp terminals. IP20 Finger safe construction. Suitable for field- and factory installation. Shipped in open position.
Ferrules	allowed, but not required
Pull-out force	10AWG:80N, 12AWG:60N, 14AWG:50N, 16AWG:40N (according to UL486E)

	Input terminals	Output and DC-OK-Signal terminals
Solid wire	0.5-6mm ²	0.3-4mm ²
Stranded wire	0.5-4mm ²	0.3-2.5mm ²
American wire gauge	20-10 AWG	26-12 AWG
Wire stripping length	10mm / 0.4inch	6mm / 0.25inch

Fig. 14-1 Connecting a wire

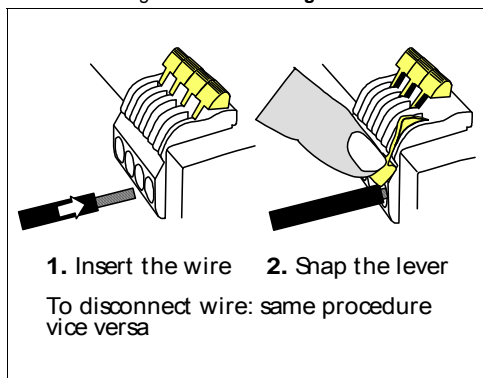

Instructions:

- Use appropriate copper cables that are designed for an operating temperature of:
60°C for ambient up to 45°C and
75°C for ambient up to 60°C minimum.
- Follow national installation codes and installation regulations!
- Ensure that all strands of a stranded wire enter the terminal connection!
- Up to two stranded wires with the same cross section are permitted in one connection point (except PE wire).
- Do not use the unit without PE connection.

15. RELIABILITY

		AC 100V	AC 120V	AC 230V	
Lifetime expectancy	min.	68 000h	75 000h	94 000h	40°C, 24V, 3.8A
	min.	122 000h	126 000h	126 000h	40°C, 24V, 1.9A
	min.	15 years	15 years	15 years	25°C, 24V, 3.8A
MTBF SN 29500, IEC 61709		787 000h	812 000h	831 000h	40°C, 24V, 3.8A
		1 374 000h	1 409 000h	1 338 000h	25°C, 24V, 3.8A
MTBF MIL HDBK 217F		352 000h	375 000h	391 000h	40°C, 24V, 3.8A, Ground Benign GB40
		482 000h	509 300h	536 000h	25°C, 24V, 3.8A, Ground Benign GB25

The **Lifetime expectancy** shown in the table indicates the operating hours (service life) and is determined by the lifetime expectancy of the built-in electrolytic capacitors.

Lifetime expectancy is specified in operational hours. Lifetime expectancy is calculated according to the capacitor's manufacturer specification. The prediction model allows a calculation of up to 15 years from date of shipment.

MTBF stands for **Mean Time Between Failure**, which is calculated according to statistical device failures, and indicates reliability of a device. It is the statistical representation of the likelihood of the unit to fail and does not necessarily represent the life of a product.

1606- XLSDNET4 24V, 3.8A; Single Phase Input

16. EMC

The power supply is suitable for applications in industrial environment as well as in residential, commercial and light industry environment without any restrictions. CE mark is in conformance with EMC guideline 89/336/EEC and 93/68/EEC and the low-voltage directive (LVD) 73/23/EWG.

EMC Immunity	EN 61000-6-1 EN 61000-6-2		Generic standards	
Electrostatic discharge	EN 61000-4-2	Contact discharge	8kV	Criterion A
		Air discharge	15kV	Criterion A
Electromagnetic RF field	EN 61000-4-3	80MHz-1GHz	10V/m	Criterion A
Fast transients (Burst)	EN 61000-4-4	Input lines	4kV	Criterion A
		Output lines	2kV	Criterion A
Surge voltage on input	EN 61000-4-5	L → N	2kV	Criterion A
		N / L → PE	4kV	Criterion A
Surge voltage on output	EN 61000-4-5	+ → -	500V	Criterion A
		+ / - → PE	500V	Criterion A
Conducted disturbance	EN 61000-4-6	0.15-80MHz	10V	Criterion A
Mains voltage dips	EN 61000-4-11	70% of 100Vac	70Vac, 10ms	Criterion A
		40% of 100Vac	40Vac, 100ms	Criterion C
		40% of 100Vac	40Vac, 1000ms	Criterion C
Voltage interruptions	EN 61000-4-11		0Vac, 5000ms	Criterion C
Voltage sags	SEMI F47 0200		96Vac, 1000ms	Criterion A
			84Vac, 500ms	Criterion A
			60Vac, 200ms	Criterion A
Input voltage swells	RA internal standard		300Vac, 500ms	Criterion A
Powerful transients	VDE 0160	over entire load range	750V, 1.3ms	Criterion A

Criteria:

A: Power supply shows normal operation behavior within the defined limits.

C: Temporary loss of function is possible. Power supply might shut-down and restarts by itself. No damages or hazards for the power supply occur.

EMC Emission	EN 61000-6-3 and EN 61000-6-4		Generic standards
Conducted emission	EN 55011, EN 55022, FCC Part 15, CISPR 11, CISPR 22		Class B, input lines
		EN 55022	Class B, output lines
Radiated emission	EN 55011, EN 55022		Class B
Harmonic input current	EN 61000-3-2		Fulfilled, active PFC
Voltage fluctuations, flicker	EN 61000-3-3		Fulfilled

This device complies with FCC Part 15 rules.

Operation is subjected to following two conditions: (1) this device may not cause harmful interference, and (2) this device must accept any interference received, including interference that may cause undesired operation.

Switching Frequencies	The power supply has three converters with three different switching frequencies included. Two are nearly constant. The other one is input voltage and load dependent.	
Switching frequency 1	110kHz	nearly constant
Switching frequency 2	400kHz	nearly constant
Switching frequency 3	65kHz to 280kHz	input voltage and load dependent

1606- XLSDNET4 24V, 3.8A; Single Phase Input

17. ENVIRONMENT

Operational temperature	-25°C to +70°C (-13°F to 158°F)	reduce output power above +60°C
Output de-rating	2W/°C	+60 to +70°C (140°F to 158°F), see Fig. 17-1
Storage temperature	-40 to +85°C (-40°F to 185°F)	storage and transportation
Humidity	5 to 95% r.H.	IEC 60068-2-30 Do not energize while condensation is present
Vibration sinusoidal	2-17.8Hz: ±1.6mm; 17.8-500Hz: 2g 2 hours / axis	IEC 60068-2-6
Vibration random	0.5m ² (s ³) 2 hours / axis	IEC 60068-2-64
Shock	30g 6ms, 20g 11ms 3 bumps / direction, 18 bumps in total	IEC 60068-2-27
Altitude	0 to 6000m (0 to 20 000ft)	Reduce output power or ambient temperature above 2000m sea level.
Output de-rating (for altitude)	5W/1000m or 5°C/1000m	above 2000m (6500ft), see Fig. 17-2
Over-voltage category	III II	EN 50178, altitudes up to 2000m Altitudes from 2000m to 6000m
Degree of pollution	2	EN 50178, not conductive

Fig. 17-1 Output current vs. ambient temp.,

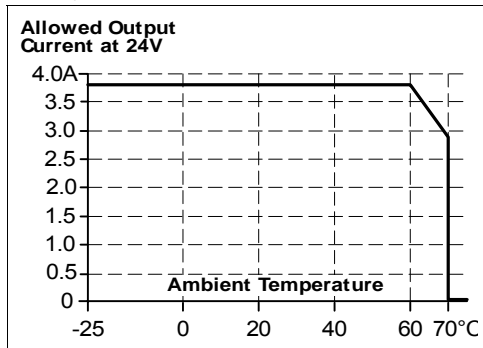
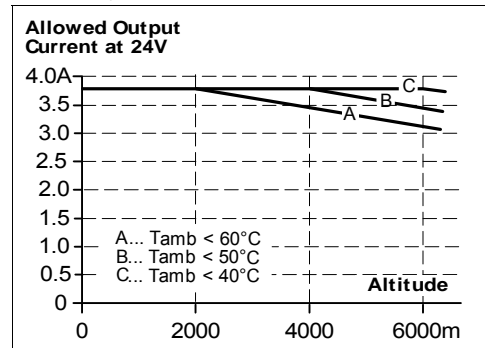

Fig. 17-2 Output current vs. altitude



The ambient temperature is defined as the air temperature 2cm below the unit.

1606- XLSDNET4 24V, 3.8A; Single Phase Input

18. PROTECTION FEATURES

Output protection	Electronically protected against overload, no-load and short-circuits	
Output over-voltage protection	typ. 27Vdc max. 29Vdc	In case of an internal power supply defect, a redundant circuitry limits the maximum output voltage. The output shuts-down and automatically attempts to restart.
Output over-current protection	Electronically limited	See Error! Reference source not found.
Degree of protection	IP 20	EN/IEC 60529
Penetration protection	> 3.5mm	e.g. screws, small parts
Over-temperature protection	yes	output shut-down with automatic restart
Input transient protection	MOV (Metal Oxide Varistor) and active transient filter	
Internal input fuse	T3.15A H.B.C.	not user replaceable

Note: In case of a protection event, audible noise may occur.

19. SAFETY

Input / output separation	SELV PELV double or reinforced insulation	IEC/EN 60950-1 EN 60204-1, EN 50178, IEC 60364-4-41
Class of protection	I	PE (Protective Earth) connection required
Isolation resistance	> 5MΩ	input to output, 500Vdc
PE resistance	< 0.1Ω	between housing and PE terminal
Touch current (leakage current)	typ. 0.11mA typ. 0.16mA typ. 0.27mA < 0.14mA < 0.22mA < 0.40mA	100Vac, 50Hz, TN mains 120Vac, 60Hz, TN mains 230Vac, 50Hz, TN mains 110Vac, 50Hz, TN mains 132Vac, 60Hz, TN mains 264Vac, 50Hz, TN mains

20. DIELECTRIC STRENGTH

⚠ WARNING

To fulfill the PELV requirements according to EN60204-1 § 6.4.1, we recommend that either the + pole, the – pole or any other part of the output circuit shall be connected to the protective earth system. This helps to avoid situations in which a load starts unexpectedly or can not be switched off any more when unnoticed earth faults occur.

Fig. 20-1 Dielectric strength

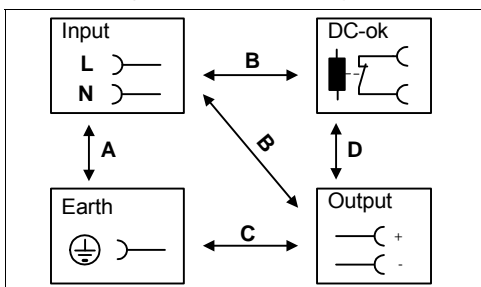

The output voltage is floating and has no ohmic connection to ground.

		A	B	C	D
Type test	60s	2500Vac	3000Vac	500Vac	500Vac
Factory test	5s	2500Vac	2500Vac	500Vac	500Vac
Field test	5s	2000Vac	2000Vac	500Vac	500Vac

Type tests and factory tests:

Conducted by the manufacturer. Do not repeat test in field!

Rules for field test:

Use appropriate test equipment which applies the voltage with a slow ramp! Connect L and N together as well as all output poles.

Rockwell Automation

1606- XLSDNET4 24V, 3.8A; Single Phase Input

21. APPROVALS

IEC 60950-1	 CB SCHEME	CB Scheme, Information Technology Equipment
UL 508		LISTED E198865 listed for use in U.S.A. (UL 508) and Canada (C22.2 No. 14-95) Industrial Control Equipment
UL 60950-1		RECOGNIZED E137006 recognized for the use in U.S.A. (UL 60950-1) and Canada (C22.2 No. 60950) Information Technology Equipment, Level 5
UL 1604		RECOGNIZED E246877 recognized for use in U.S.A. (UL 1604) and Canada (C22.2 No. 213-M1987) Hazardous Location Class I Div 2 T4 Groups A,B,C,D and Class I Zone 2 Groups IIA, IIB and IIC
<p>The unit is suitable for use in Class I Division 2 Groups A, B, C, D locations as well as for Class I Zone 2 Groups IIA, IIB and IIC locations. Substitution of components may impair suitability for Class I Division 2 environment. Do not disconnect equipment unless power has been switched off. Wiring must be in accordance with Class I, Division 2 wiring methods of the National Electrical Code, NFPA 70, and in accordance with other local or national codes.</p>		
SEMI F47		SEMI F47-0200 Power Quality Star Ride-through compliance for semiconductor industry. Full SEMI range compliance (Input: 120Vac or 208Vac, output: 240W)

22. FULFILLED STANDARDS

EN 61558-2-17	Safety of Power Transformers
EN/IEC 60204-1	Safety of Electrical Equipment of Machines
EN/IEC 61131-2	Programmable Controllers
EN 50178, IEC 62103	Electronic Equipment in Power Installations

23. USED SUBSTANCES

The unit does not release any silicone and is suitable for the use in paint shops.

Electrolytic capacitors included in this unit do not use electrolytes such as Quaternary Ammonium Salt Systems.

Plastic housings and other molded plastic materials are free of halogens, wires and cables are not PVC insulated.

The materials used in our production process do not include the following toxic chemicals:
Polychlorinated Biphenyl (PCB), Pentachlorophenol (PCP), Polychlorinated naphthalene (PCN), Polybrominated Biphenyl (PBB), Polybrominated Biphenyl Oxide (PBO), Polybrominated Diphenyl Ether (PBDE), Polychlorinated Diphenyl Ether (PCDE), Polybrominated Diphenyl Oxide (PBDO), Cadmium, Asbestos, Mercury, Silica

1606- XLSDNET4 24V, 3.8A; Single Phase Input

24. PHYSICAL DIMENSIONS AND WEIGHT

Weight	620g / 1.37lb
DIN-Rail	Use 35mm DIN-rails according to EN 60715 or EN 50022 with a height of 7.5 or 15mm. The DIN-rail height must be added to the depth (117mm) to calculate the total required installation depth.

Fig. 24-1 Front view

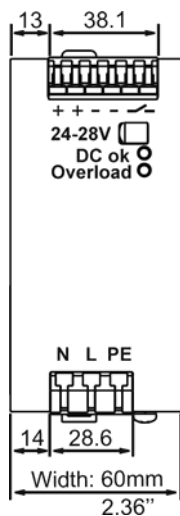
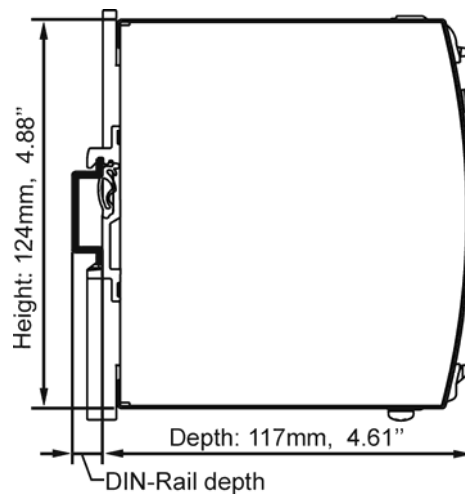

Fig. 24-2 Side view



25. INSTALLATION AND OPERATION INSTRUCTIONS

⚠ WARNING

Hazardous voltage inside device. Risk of electric shock, severe burns, or death.

- Do not use the unit without proper earth connection (Protective Earth). Use the pin on the terminal block for earth connection and not one of the screws on the housing.
- Turn power off before working on the power supply. Protect against inadvertent re-powering.
- Make sure the wiring is correct by following all local and national codes.
- Do not open, modify or repair the unit.
- Use caution to prevent any foreign objects from entering into the housing.
- Do not use in wet locations or in areas where moisture or condensation can be expected.

Mounting:

Output terminal must be located on top and input terminal on the bottom. For other orientations see section 27.9. An appropriate electrical and fire end-product enclosure needs to be considered in the end use application.

Cooling:

Convection cooled, no forced cooling required. Do not cover ventilation grid (e.g. cable conduits) by more than 30%!

Installation clearances:

40mm on top, 20mm on the bottom, 5mm on the left and right side are recommended when loaded permanently with full power. In case the adjacent device is a heat source, 15mm clearance is recommended.

Service parts:

The unit does not contain any serviceable parts. The tripping of an internal fuse is caused by an internal defect.

1606- XLSDNET4 24V, 3.8A; Single Phase Input

26. ACCESSORIES

1606-XLB Wall mounting bracket

This bracket is used to mount Dimension units onto a flat surface without utilizing a DIN-Rail. The two aluminum brackets and the black plastic slider of the unit have to be detached, so that the two steel brackets can be mounted.

Fig. 26-1 1606-XLB Wall Mounting Bracket

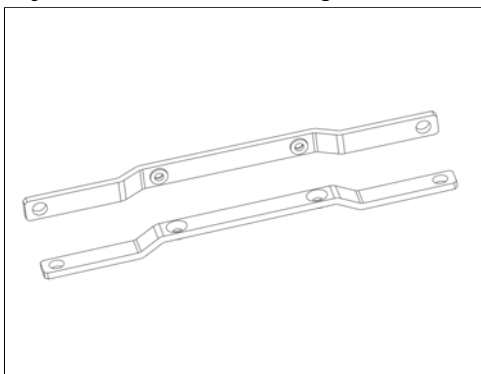
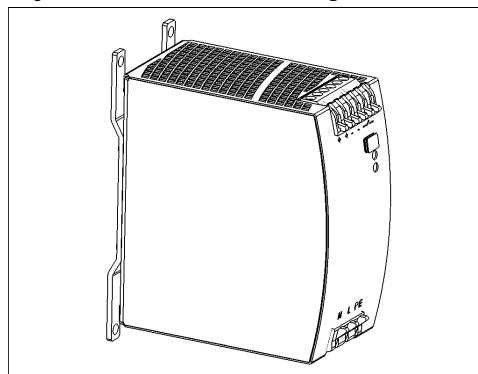

Fig. 26-2 Assembled Wall Mounting Bracket



1606- XLSDNET4 24V, 3.8A; Single Phase Input

27. APPLICATION NOTES

27.1. PEAK CURRENT CAPABILITY

Solenoids, contactors and pneumatic modules often have a steady state coil and a pick-up coil. The inrush current demand of the pick-up coil is several times higher than the steady state current and usually exceeds the nominal output current (including the Power-Boost) The same situation applies, when starting a capacitive load.

Branch circuits are often protected with circuit breakers or fuses. In case of a short or an overload in the branch circuit, the fuse needs a certain amount of over-current to trip or to blow. The peak current capability ensures the safe operation of subsequent circuit breakers.

Assuming the input voltage is turned on before such an event, the built-in large sized output capacitors inside the power supply can deliver extra current. Discharging this capacitor causes a voltage dip on the output. The following two examples show typical voltage dips:

Fig. 27-1 Peak load 7.6A for 50ms, typ.

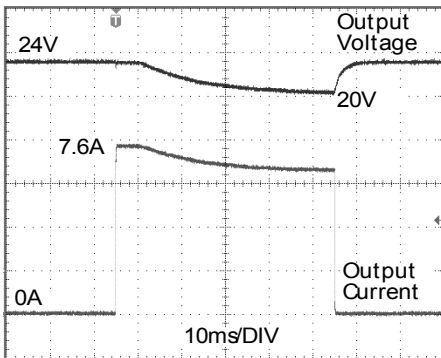

Peak load 7.6A (resistive) for 50ms
Output voltage dips from 24V to 20V.

Fig. 27-2 Peak load 15A for 5ms, typ.

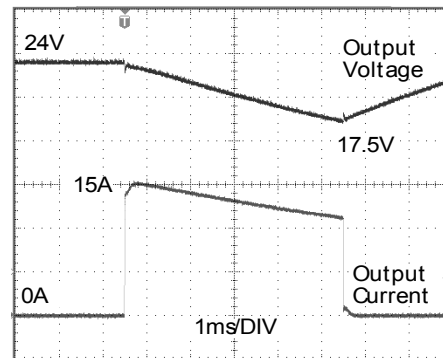

Peak load 15A (resistive) for 5ms
Output voltage dips from 24V to 17.5V.

Please note: The DC-OK relay triggers when the voltage dips more than 10% for longer than 1ms.

27.2. BACK-FEEDING LOADS

Loads such as decelerating motors and inductors can feed voltage back to the power supply. This feature is also called return voltage immunity or resistance against Back- E.M.F. (Electro Magnetic Force).

This power supply is resistant and does not show malfunctioning when a load feeds back voltage to the power supply. It does not matter, whether the power supply is on or off.

The maximum allowed feed back voltage is 28Vdc. The absorbing energy can be calculated according to the built-in large sized output capacitor which is specified in chapter 8.

27.3. PARALLEL AND SERIAL USE

Do not use the 1606-XLSDNET4 power supplies in parallel to increase the output power or in series for a higher output voltage. The NEC Class 2 requirements in the system will be violated if such power supplies are used in parallel. If higher power is needed choose 1606-XLSDNET8. However, power supplies can be used in parallel to build redundant systems.

1606- XLSDNET4 24V, 3.8A; Single Phase Input

27.4. OUTPUT CIRCUIT BREAKERS

Standard miniature circuit breakers (MCBs) can be used for branch protection. Ensure that the MCB is rated for DC voltage, too. The following tests show which circuit breakers the power supply typically trips.

Circuit breakers have huge tolerances in their tripping behavior. Therefore, these typical tests can only be used as a recommendation or for comparing two different power supplies. Furthermore, the loop impedance has a major influence on whether a breaker trips or not. Two tests were performed, representing typical situations:

Test 1: Short circuit with S1 on the power supply end of the cable (loop impedance approx. 20mOhm)

Fig. 27-3 Branch protectors, test circuit 1

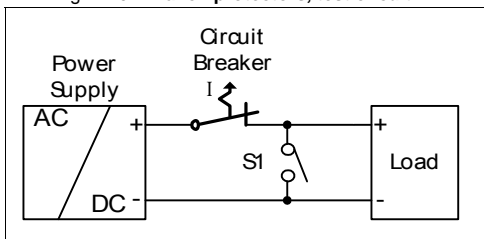

Parameters:

Input voltage: 230Vac, load current: 0A
 Tripping time shorter than 5s.

The following circuit breaker tripped during the test:

- A- or Z- Characteristic: equal or smaller 10A
- B- Characteristic: equal or smaller 6A
- C- Characteristic: equal or smaller 3A

Test 2: Short circuit with S1 on the load end (additional impedance included; represents longer load wire length).

Fig. 27-4 Branch protectors, test circuit 2

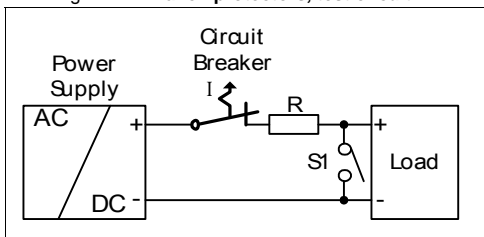

Parameters:

Input voltage: 230Vac, load current: 0A
 Tripping time shorter than 5s.

The following circuit breaker tripped during the test:

- A- or Z- Characteristic: ≤ 6A and R < 180mOhm
- C- Characteristic: ≤ 2A and R < 270mOhm

What does this resistance mean in wire length?

	0.5mm ²	0.7mm ²	1.0mm ²	1.5mm ²	2.5mm ²	4.0mm ²
180mOhm	5.0m	7.0m	10.0m	15.0m	25.1m	40.1m
270mOhm	7.5m	10.5m	15.0m	22.6m	37.6m	60.2m

Example:

Which wire gauge must be used to trip a C-Characteristic circuit breaker with a rating of 2A? The load wire length is 21m.

Answer: A 2A C-Characteristic circuit breaker requires a loop impedance of less than 270mOhm (test results). The wire length table shows that up to 22.6m wire with a cross section of 1.5mm² are below 270mOhm. A wire not smaller than 1.5mm² shall be used.

27.5. EXTERNAL INPUT PROTECTION

The unit is tested and approved for branch circuits up to 20A. External protection is only required, if the supplying branch has an ampacity greater than this. In some countries local regulations might apply. Check also local codes and local requirements.

If an external fuse is necessary or utilized, a minimum value is required to avoid undesired tripping of the fuse.

		B-Characteristic	C-Characteristic
Ampacity	max.	20A	20A
	min.	6A	3A

1606- XLSDNET4 24V, 3.8A; Single Phase Input

27.6. INDUCTIVE AND CAPACITIVE LOADS

The unit is designed to supply any kind of load, including unlimited capacitive and inductive loads.

27.7. OPERATION ON TWO PHASES

Fig. 27-5 Schematic for two phase operation

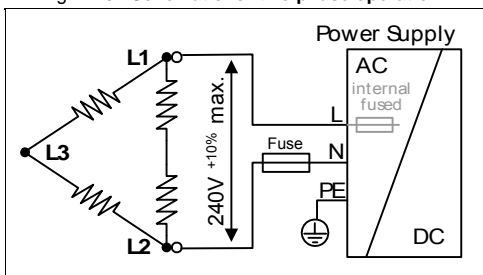

Instructions for two phase operation:

- A phase to phase connection is allowed as long as the supplying voltage is below 240V(10%).
- Use a fuse or a circuit breaker to protect the N input. The N input is internally not protected and is in this case connected to a hot wire.

Appropriate fuses or circuit breakers are specified in section 27.3 "External Input Protection".

27.8. USE IN A TIGHTLY SEALED ENCLOSURE

When the power supply is installed in a tightly sealed enclosure, the temperature inside the enclosure will be higher than outside. The inside temperature defines the ambient temperature for the power supply.

Results from such an installation:

Power supply is placed in the middle of the box, no other heat producer inside the box

Enclosure: Typ IP66 Box PK 9516 100, plastic, 110x180x165mm

Load: 24V, 3.8A; (=80%) load is placed outside the box

Input: 230Vac

Temperature inside enclosure: 42.3°C (in the middle of the right side of the power supply with a distance of 2cm)

Temperature outside enclosure: 23.3°C

Temperature rise: 19.0 °C

1606- XLSDNET4 24V, 3.8A; Single Phase Input

27.9. MOUNTING ORIENTATIONS

Mounting orientations other than input terminals on the bottom and output on the top require a reduction in continuous output power or a limitation in the max. allowed ambient temperature. The amount of reduction influences the lifetime expectancy of the power supply. Therefore, two different derating curves for continuous operation can be found below:

Curve A1 Recommended output current.

Curve A2 Max allowed output current (results approx. in half the lifetime expectancy of A1).

Fig. 27-6 Mounting Orientation A
Standard Orientation

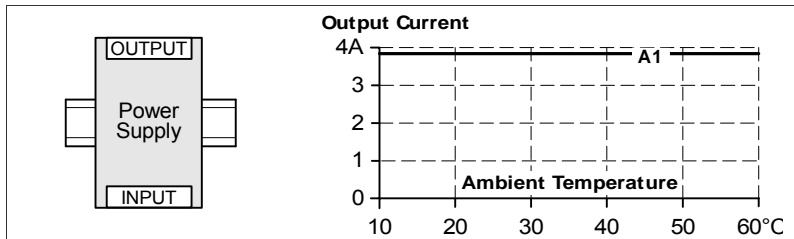

Fig. 27-7 Mounting Orientation B
(Upside down)

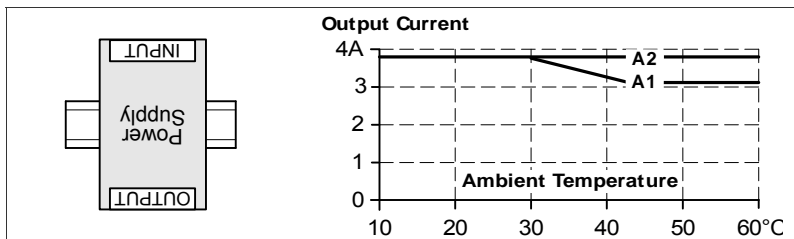

Fig. 27-8 Mounting Orientation C
(Table-top mounting)

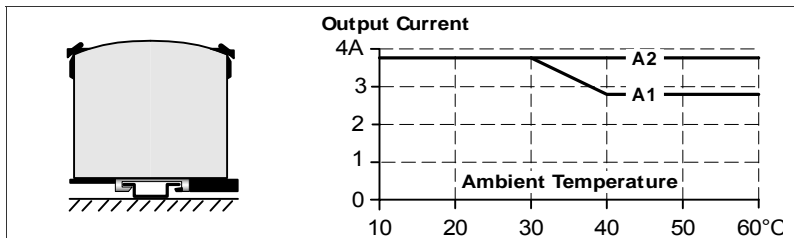

Fig. 27-9 Mounting Orientation D
(Horizontal cw)

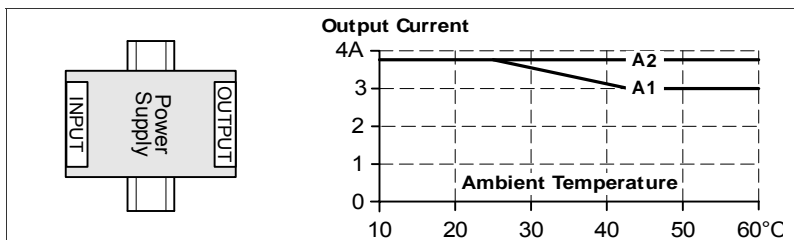

Fig. 27-10 Mounting Orientation E
(Horizontal ccw)

