

Installation Instructions

42JT VisiSight™ Photoelectric Diffuse Sensors with IO-Link

IMPORTANT: SAVE THESE INSTRUCTIONS FOR FUTURE USE.

Default Settings:

The factory default settings are configured so that no teaching is required for a vast majority of the applications.

Sensing Range: Maximum Setting

Output Mode: Light Operate (Output ON when target is detected)

Output Type: Auto PNP/NPN or IO-Link. In Auto PNP/NPN mode, the sensor continuously monitors the load connection and automatically configures the output to PNP or NPN.

Sensor User Interface

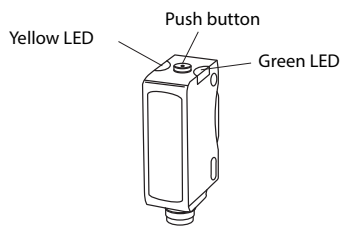

LED Status

The table below provides LED status in the RUN mode, during operation. The sensor is always in RUN mode, except when being taught.

Auto PNP/NPN Operation

Green	OFF	Power is OFF
	ON	Power is ON
	Flashing (6 Hz)	Unstable light level (0.5 < margin < 2)
	Flashing (1.5 Hz)	Output short circuit protection active
Yellow	OFF	Output de-energized
	ON	Output energized

IO-Link Operation

Green	OFF	Power is OFF
	Flashing (1 Hz)	Power is ON
Yellow	OFF	Output de-energized
	ON	Output energized

① Connection Types

Cat. No. Suffix	Description
-A2	2 m cable
-P4	Integral 4-pin pico (M8) QD
-F4	4-pin DC micro (M12) QD on 150 mm (6 in.) pigtail
-Y4	4-pin pico (M8) QD on 150 mm (6 in.) pigtail

General Specifications

	42JT-D2LAT1-①	42JT-D8LAT1-①
Environmental		
Certifications	cULus and CE Marked for all applicable directives	
Operating Environment	IP67, IP69K, ECOLAB②	
Operating Temperature [C (F)]	-20...+60° (-4...+140°)③	
Storage Temperature [C (F)]	-20...+80° (-4...+179°)	
Optical		
Light Source	Visible red 660 nm	Class 1 laser 650 nm
Sensing Range	3...800 mm (0.12...31.5 in.)	1...250 mm (0.04...9.8 in.)
Adjustments	Push button	
Electrical		
Voltage	10...30V DC④	
Current Consumption	30 mA max.	
Sensor Protection	Reverse polarity, short circuit, overload protection	
Outputs		
Response Time	0.5 ms max.	0.33 ms max.
Output Type	Auto NPN or PNP	
Output Function	Selectable light operate or dark operate	
Output Current	100 mA max.	
Output Leakage Current	10 µA max.	
Mechanical		
Housing Material	ABS	
Lens Material	PMMA	
Cover Material	PMMA	

① see Connection Types table

② ECOLAB on P4 and A2 models only.

③ UL: -20...+50°C (-4...122°F)

④ UL: Class 2 source

Mounting the Sensor

Securely mount the sensor on a firm, stable surface or support. An application which is subject to excessive vibration or shifting may cause intermittent operation. For installation convenience, Rockwell Automation offers a wide range of mounting brackets (see the Accessories section for more details).

Alignment Indication

For short range applications the visible light beam of the sensor suffices as alignment aid.

The alignment feature may be used for longer range applications. Alignment of the sensor is indicated via change in intensity of the green LED in the Alignment Mode, as follows:

1. Press and release the push button twice within three seconds. After three seconds, the green LED turns OFF for 0.5 second indicating the sensor is in the alignment mode.
2. Align sensor to the target to be detected. Intensity of green LED increases with better alignment. Secure it in a position that yields the highest intensity of the green LED. Press and release the button once to return to the RUN mode, or the sensor automatically returns to RUN mode in two minutes.

VisiSight™ Configuration

The 42JT VisiSight is configured using the push button or Remote Teach or IO-Link and the LED indicators on the sensor. Five features may be configured:

- Static Teach: Standard or precision teach for sensitivity/sensing range
- Dynamic Teach (running process)
- Light operate (LO) or dark operate (DO) output
- Auto PNP/NPN, dedicated NPN or dedicated PNP
- Push button lock/unlock

The sensor output is disabled during Teach.

Teach Sensitivity/Sensing Range

The default setting is the maximum sensitivity/range.

Static Teach:

Teaching the sensitivity/sensing range is a two step process: teach “target” (1st condition) and teach “no target” (2nd condition). Switching threshold for output ON vs. OFF is set in between the two conditions.

Standard Teach:

1. To teach the “target” (first condition):

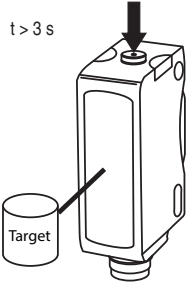
$t > 3 \text{ s}$ 	<p>Place the target at the desired maximum distance. Press and hold the button for three seconds until the yellow LED starts flashing. Release the button. The first condition has now been taught.</p>
--	---

2. Teach “no target” (second condition):

$t < 0.5 \text{ s}$ 	<p>Remove the target. Press and release the button. The teach process is complete.</p> <p>If the push button is not pressed within 30 seconds, the sensor exits teach mode and returns to RUN mode without learning the new setting.</p>
--	--

Note: The sensor can also be taught by teaching “no target” as the first condition and “target” as the second condition.

Precision Teach: If there is nothing in the field of view in step two, the sensing range will be set farther than the target to maximize excess gain and improve detection reliability. For a more precise setting with less excess gain, do not remove the target in step two (i.e. the target is present for both step one and step two). Also use precision teach for contrast applications.

Restore to factory default setting of maximum range: Perform steps one and two with “no target” in the sensor’s field of view.

Dynamic Teach (Running Process):

If the targets to be detected are moving with the sensor aimed at the running process, press and hold the button for three seconds until the yellow LED starts flashing. The sensitivity will automatically be taught in the next 30 seconds provided the sensor sees two cycles of “target” and “no target.” The switching threshold for output ON vs. OFF is set in between the two conditions.

Teach Light Operate (L.O.) or Dark Operate (D.O.)

The default setting of the output is light operate (L.O.)

The L.O. setting means that output turns ON when the target is detected. If the application requires the output to turn OFF when the target is detected, the setting may be changed to dark operate (D.O.).

1. To access the teach output mode setting:

$t > 6 \text{ s}$ 	<p>Press and hold button for six seconds until green LED starts flashing. Release the button. The current setting is indicated by the yellow LED: L.O.: Yellow LED ON D.O.: Yellow LED OFF</p>
---	--

2. To change the sensor output mode setting:

$t < 0.5 \text{ s}$ 	<p>Press and release the button within ten seconds to toggle from L.O. to D.O., the selection indicated by the yellow LED.</p> <p>The sensor retains the setting per the last button depression and returns to the RUN mode ten seconds after the last button is depressed.</p>
---	---

Output Type Selection:

Auto PNP/NPN, Dedicated NPN, Dedicated PNP

The default setting is Auto PNP/NPN. This means the sensor monitors the load connection and automatically configures for the proper operation, i.e., PNP or NPN. If no load is connected, the sensor defaults to PNP.

The following applications are covered with dedicated PNP or dedicated NPN selection:

- Parallel wiring of multiple sensor outputs: select dedicated PNP or dedicated NPN setting, as needed.
- If the load is connected for NPN configuration but to a different power supply than the power to the sensor or via a load enabling contact (e.g., a relay contact in series with the load): select dedicated NPN.

Selection can be made as follows:

- To access output type:** Press and hold the push button for 12 seconds (until both LEDs start flashing synchronously). At the release of the button, the current setting of output type is indicated by the slow flashing of the LED (or LEDs) as follows:

- Auto PNP/NPN: both LEDs flashing
- Dedicated NPN: green LED flashing
- Dedicated PNP: yellow LED flashing

- To change output type:** Press and release the push button within ten seconds to select desired type. Each press of the button will cycle to the next output setting. The type selected is indicated by the LEDs. The sensor retains the setting per the last button depression and returns to the RUN mode ten seconds after the last button is pressed.

Push Button Lock/Unlock

The push button or remote teach (RT) can be used to prevent unauthorized users from changing teach settings.

To lock the push button: press and release the button three times within three seconds. Both LEDs flash synchronously for three seconds indicating that the push button is now locked.

To unlock the push button: press and release the button three times within three seconds. Both LEDs flash asynchronously for three seconds indicating that the push button is now unlocked.

Permanent lock: The push button may be permanently locked by connecting the white wire (pin 2) to -V.

Remote Teach (RT)

The sensor can be taught remotely via the white wire (pin 2). Connection to +V acts the same as the button being pressed and no connection is the same as the button not being pressed. The sensor can be taught by following the same teach/timing sequence as used in the push button teach (e.g., connect to the +V for more than three seconds to teach the "target," disconnect from the +V; remove the target and connect to the +V for less than one second to teach the "no target" condition. All push button functions can also be carried out via RT.

IO-Link

See instructions for IO-Link on www.ab.com. Remote Teach (pin 2) is disabled in IO-Link operation. If output is selected as dedicated NPN, IO-Link communication is unavailable.

Wiring Diagrams

The quick-disconnect connector is shown in the following diagrams. The pin numbers correspond to male connectors on the sensor.

Micro (M12) Male QD on Pigtail and Integral Pico (M8) Male QD

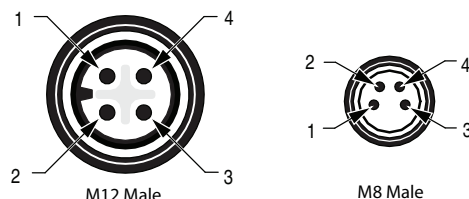

Output Wiring

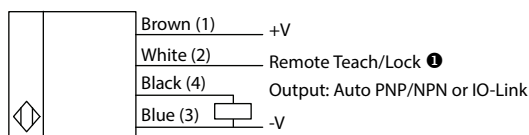

- Normal operation:** No connection. Disabled in IO-Link operation.
- Remote Teach:** Refer to the Remote Teach section.
- Push Button Lock:** Connect to -V. See the Push button Lock/Unlock section.

Approximate Dimensions [mm (in.)]

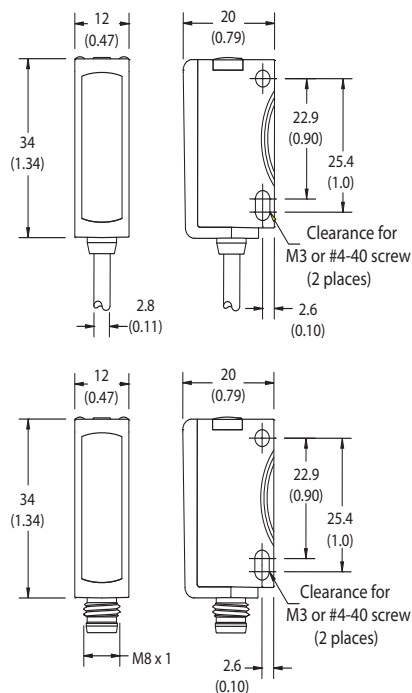

Accessories

Stainless Steel Mounting Brackets

1) 60-BJS-L1

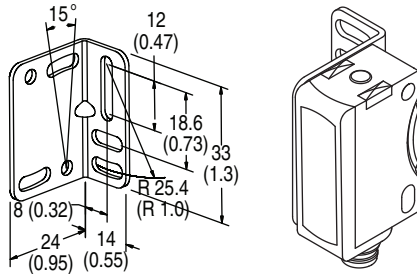

2) 60-BJT-L2

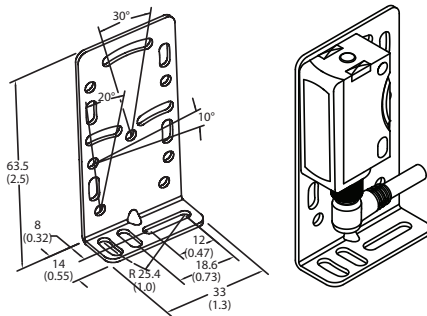

3) 60-2619 VisiSight-compatible swivel/tilt mounting bracket

Typical Response Curves

Standard Diffuse (800 mm)

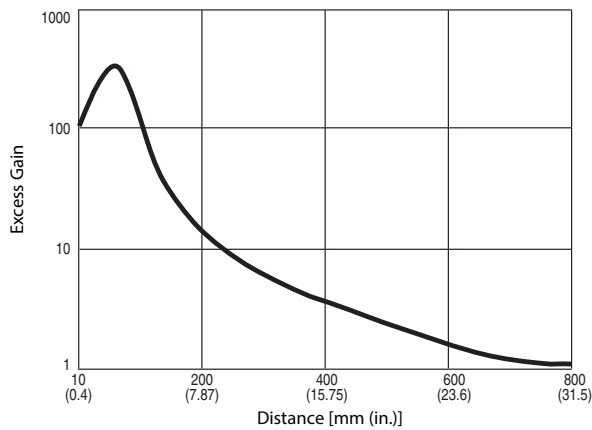

Spot Size (800 mm)

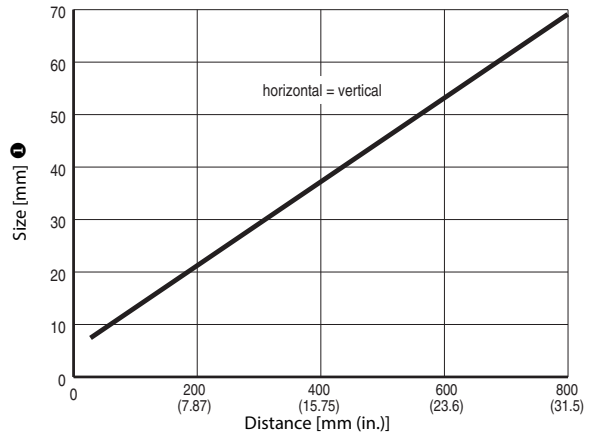

Laser Diffuse (250 mm)

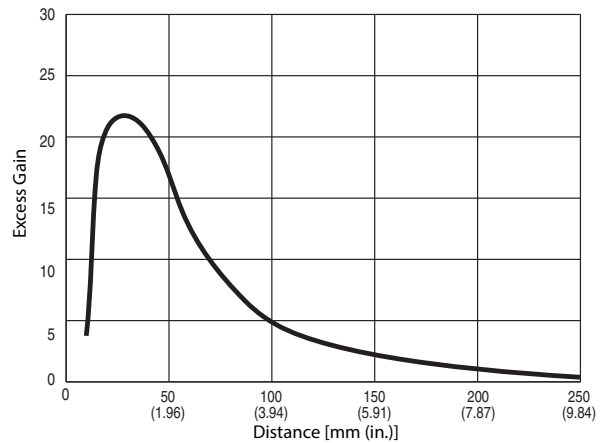

Laser Spot Size (250 mm)

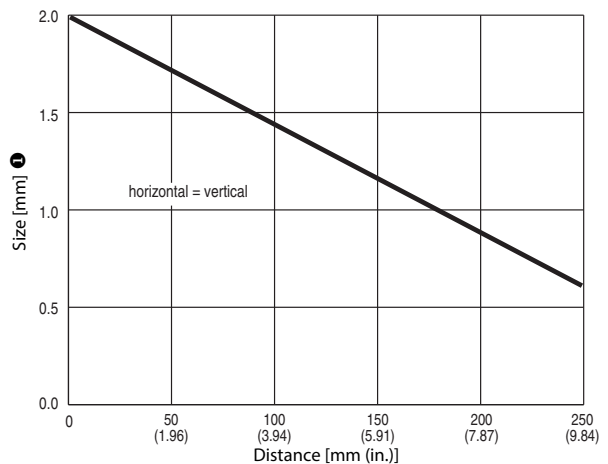

① The spot size is square in shape with one side dimension per the graph.

Rockwell Automation maintains current product environmental information on its website at

<http://www.rockwellautomation.com/rockwellautomation/about-us/sustainability-ethics/product-environmental-compliance.page>

www.rockwellautomation.com

Power, Control and Information Solutions Headquarters

Americas: Rockwell Automation, 1201 South Second Street, Milwaukee, WI 53204-2496 USA, Tel: (1) 414.382.2000, Fax: (1) 414.382.4444

Europe/Middle East/Africa: Rockwell Automation NV, Pegasus Park, De Kleetlaan 12a, 1831 Diegem, Belgium, Tel: (32) 2 663 0600, Fax: (32) 2 663 0640

Asia Pacific: Rockwell Automation, Level 14, Core F, Cyberport 3, 100 Cyberport Road, Hong Kong, Tel: (852) 2887 4788, Fax: (852) 2508 1846