

30.75 [1 13/64]

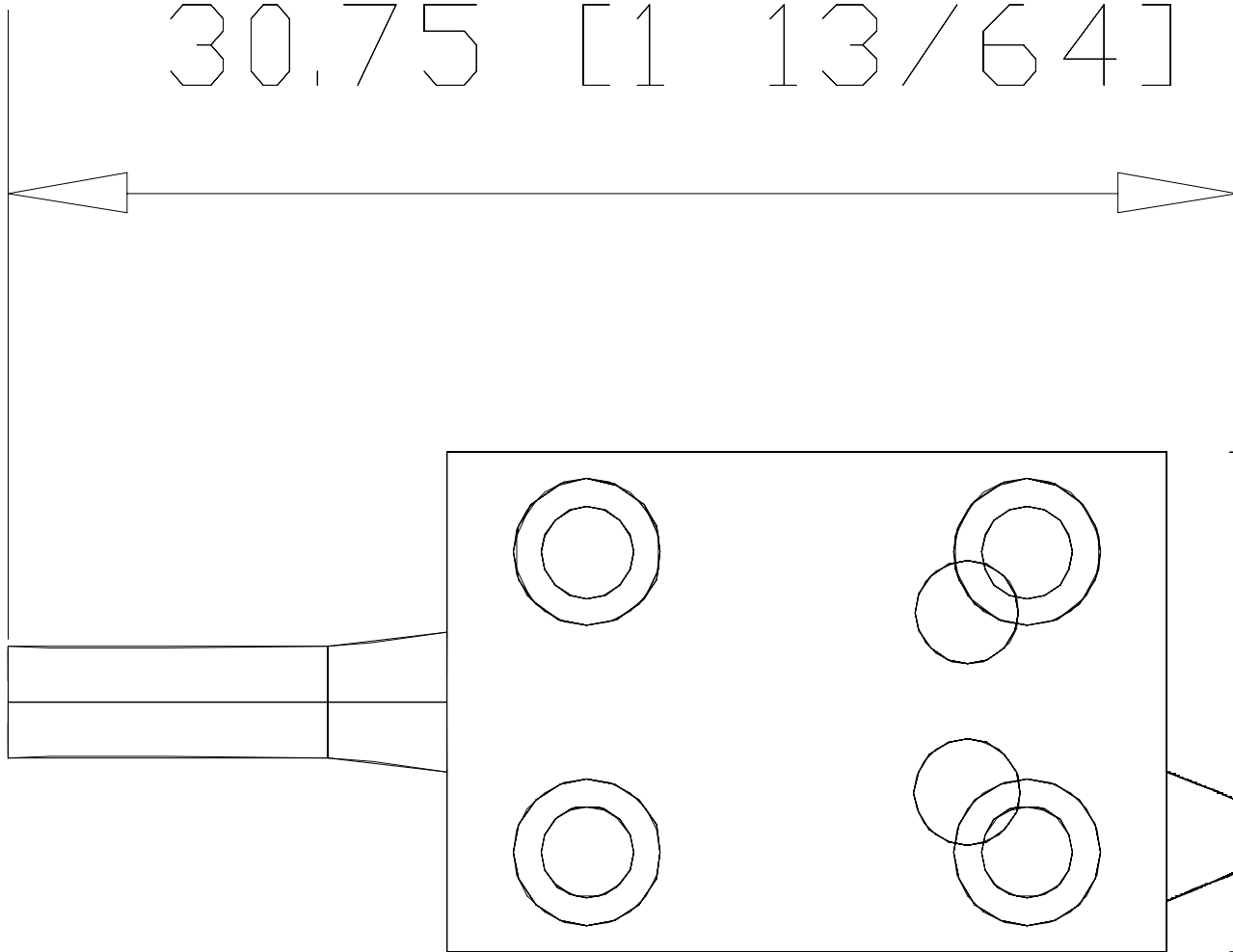

12.50 [31/64]

