

Push-in Terminal Block Specifications

Bulletin Number 1492-P

Topic	Page
Single-level, Feed-through Terminal Blocks	2
Single-level, Feed-through Grounding Terminal Blocks	14
Double-level, Feed-through Terminal Blocks	25
Double-level, Feed-through Grounding Terminal Blocks	27
Three-level, Feed-through Terminal Blocks	29
Three-level, Feed-through Grounding Terminal Blocks	31
Four-level Feed-through Terminal Blocks	33
Disconnect Terminal Blocks	34
Sensor Terminal Blocks	37
Control Power Distribution Terminal Blocks	42
Single-level Flex Plug-in Terminal Blocks	58
Double-level Flex Plug-in Terminal Blocks	60
Accessory Plug-in Terminal Blocks	64
Fuse Terminal Blocks	67
Panduit Ferrules and Tools for use with 1492-P2 Terminal Blocks	68
Panduit Ferrules and Tools for use with 1492-P3 Terminal Blocks	69
Panduit Ferrules and Tools for use with 1492-P4 Terminal Blocks	70
Panduit Ferrules and Tools for use with 1492-P6 Terminal Blocks	71
Panduit Ferrules and Tools for use with 1492-P10 Terminal Blocks	72



Single-level, Feed-through Terminal Blocks

1492-P2

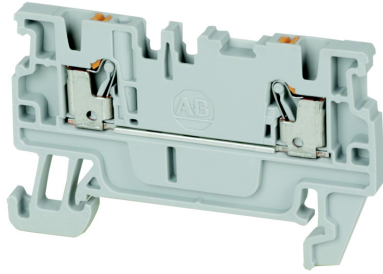

Terminal Blocks—Dimensions (W x H x L): 3.5 x 33.5 x 55 mm

Color	Cat. No.	Pkg. Qty.	Color	Cat. No.	Pkg. Qty.
Grey	1492-P2	100	Green	1492-P2-G	100
Red	1492-P2-RE	100	Yellow	1492-P2-Y	100
Blue	1492-P2-B	100	Orange	1492-P2-OR	100
Black	1492-P2-BL	100	White	1492-P2-W	100

Specifications — Single-level Feed-through Terminal Block

Certifications	UL / CSA	IEC	ATEX
Voltage Rating	300V AC/DC	500V AC/DC	550V AC/DC
Maximum Current	13 A	17.5 A	15 A
Wire Range/ Rated Cross Section	26...14 AWG	1.5 mm ²	1.5 mm ²
Wire Strip Length	0.31 in. (8 mm)		
Density	87 pcs/ft (285 pcs/m)		
Housing Temperature Range	-76...266°F (-60...130 °C)		

Accessories	Cat. No.	Pkg Qty.
-------------	----------	----------

Mounting Rails, End Barriers, End Anchors and Retainers

Mounting Rail 1 m Symmetrical DIN	Steel	199-DR1	10
	Aluminum	1492-DR5	10
	Hi-Rise (Aluminum)	1492-DR6	2
	Angled (Steel)	1492-DR7	2
End Barriers	Grey	1492-EBP2	50
	Blue	1492-EBP2-B	50
	Yellow	1492-EBP2-Y	50
End Retainer		1492-ERL35	20
End Anchor DIN Rail	Normal Duty	1492-EAJ35	100
	Heavy Duty	1492-EAHJ35	50
	Normal Duty	1492-EAP35	50

Accessories	Cat. No.	Pkg Qty.
Center Jumpers⁽¹⁾		
2-pole	1492-CJP2-2	20
3-pole	1492-CJP2-3	
4-pole	1492-CJP2-4	
5-pole	1492-CJP2-5	
6-pole	1492-CJP2-6	
7-pole	1492-CJP2-7	
8-pole	1492-CJP2-8	
9-pole	1492-CJP2-9	
10-pole	1492-CJP2-10	
20-pole	1492-CJP2-20	
50-pole	1492-CJP2-50	

Test Plugs			
Test Plugs	Start Test Plug	1492-PTPS	50
	Test Plug	1492-P2TPE	50

Marking Systems		
ClearPlot™ Basic Marker Cards	1492-M3x5 (100/card)	5 cards
ClearMultiprint™ Markers	1492-MT3X8 (1000/roll)	1 roll

(1) Available in orange as standard, to order other colors add the appropriate suffix to the catalog number listed: Blue =B, Red = RE. Example for a red 2-pole center jumper, the catalog number will be 1492-CJP2-2-RE.

Wiring Diagram



IMPORTANT See page 68 for ferrule selection.

1492-P2T

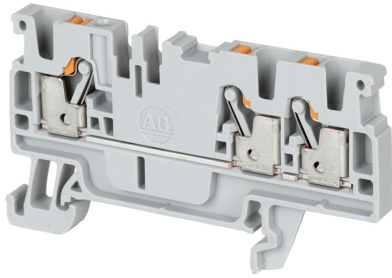

Terminal Blocks—Dimensions (W x H x L): 3.5 x 33.5 x 61.5 mm							
Color	Cat. No.	Pkg. Qty.	Color	Cat. No.	Pkg. Qty.		
	Grey	1492-P2T	50		Green	1492-P2T-G	50
	Red	1492-P2T-RE	50		Yellow	1492-P2T-Y	50
	Blue	1492-P2T-B	50		Orange	1492-P2T-OR	50
	Black	1492-P2T-BL	50		White	1492-P2T-W	50

Specifications — Single-level Feed-through Terminal Block			
Certifications	UL/CSA	IEC	ATEX
Voltage Rating	300V AC/DC	500V AC/DC	550V AC/DC
Maximum Current	13 A	17.5 A	15 A
Wire Range (Rated Cross Section)	26...14 AWG	1.5 mm ²	1.5 mm ²
Wire Strip Length	0.31 in. (8 mm)		
Density	87 pcs/ft (285 pcs/m)		
Housing Temperature Range	-76...266°F (-60...130 °C)		

Accessories	Cat. No.	Pkg Qty.	
Mounting Rails, End Barriers, End Anchors and Retainers			
Mounting Rail 1 m Symmetrical DIN	Steel	199-DR1	10
	Aluminum	1492-DR5	10
	Hi-Rise (Aluminum)	1492-DR6	2
	Angled (Steel)	1492-DR7	2
End Barriers	Grey	1492-EBP2T	50
	Blue	1492-EBP2T-B	50
	Yellow	1492-EBP2T-Y	50
End Retainer	1492-ERL35	20	
End Anchor DIN Rail	Normal Duty	1492-EAJ35	100
	Heavy Duty	1492-EAHJ35	50
	Normal Duty	1492-EAP35	50

Accessories	Cat. No.	Pkg Qty.	
Center Jumpers⁽¹⁾			
2-pole	1492-CJP2-2	20	
3-pole	1492-CJP2-3		
4-pole	1492-CJP2-4		
5-pole	1492-CJP2-5		
6-pole	1492-CJP2-6		
7-pole	1492-CJP2-7		
8-pole	1492-CJP2-8		
9-pole	1492-CJP2-9		
10-pole	1492-CJP2-10		
20-pole	1492-CJP2-20		
50-pole	1492-CJP2-50		
Test Plugs			
Test Plugs	Start Test Plug	1492-PTPS	50
	Test Plug	1492-P2TPE	50
Marking Systems			
ClearPlot Basic Marker Cards	1492-M3x5 (100/card)	5 cards	
ClearMultiprint Markers	1492-MT3X8 (1000/roll)	1 roll	

(1) Available in orange as standard, to order other colors add the appropriate suffix to the catalog number listed: Blue =B, Red = RE. Example for a red 2-pole center jumper, the catalog number will be 1492-CJP2-2-RE.

Wiring Diagram



IMPORTANT See page 68 for ferrule selection.

1492-P2Q

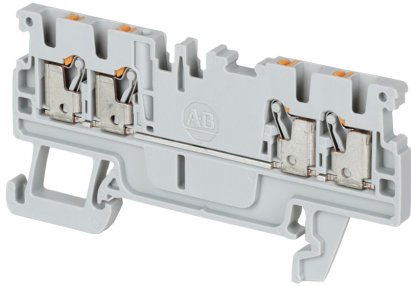

Terminal Blocks—Dimensions (W x H x L): 3.5 x 33.5 x 67.5 mm					
Color	Cat. No.	Pkg. Qty.	Color	Cat. No.	Pkg. Qty.
Grey	1492-P2Q	100	Green	1492-P2Q-G	100
Red	1492-P2Q-RE	100	Yellow	1492-P2Q-Y	100
Blue	1492-P2Q-B	100	Orange	1492-P2Q-OR	100
Black	1492-P2Q-BL	100	White	1492-P2Q-W	100

Specifications — Single-level Feed-through Terminal Block			
Certifications	UL /CSA	IEC	ATEX
Voltage Rating	300V AC/DC	500V AC/DC	550V AC/DC
Maximum Current	13 A	17.5 A	15 A
Wire Range (Rated Cross Section)	26...14 AWG	1.5 mm ²	1.5 mm ²
Wire Strip Length	0.31 in. (8 mm)		
Density	87 pcs/ft (285 pcs/m)		
Housing Temperature Range	-76...266°F (-60...130 °C)		

Accessories	Cat. No.	Pkg Qty.	
Mounting Rails, End Barriers, End Anchors and Retainers			
Mounting Rail 1 m Symmetrical DIN	Steel	199-DR1	10
	Aluminum	1492-DR5	10
	Hi-Rise (Aluminum)	1492-DR6	2
	Angled (Steel)	1492-DR7	2
End Barriers	Grey	1492-EBP2Q	50
	Blue	1492-EBP2Q-B	50
	Yellow	1492-EBP2Q-Y	50
End Retainer	1492-ERL35	20	
End Anchor DIN Rail	Normal Duty	1492-EAJ35	100
	Heavy Duty	1492-EAHJ35	50
	Normal Duty	1492-EAP35	50

Accessories	Cat. No.	Pkg Qty.
Center Jumpers⁽¹⁾		
2-pole	1492-CJP2-2	20
3-pole	1492-CJP2-3	
4-pole	1492-CJP2-4	
5-pole	1492-CJP2-5	
6-pole	1492-CJP2-6	
7-pole	1492-CJP2-7	
8-pole	1492-CJP2-8	
9-pole	1492-CJP2-9	
10-pole	1492-CJP2-10	
20-pole	1492-CJP2-20	
50-pole	1492-CJP2-50	

Test Plugs			
Test Plugs	Start Test Plug	1492-PTPS	50
	Test Plug	1492-P2TPE	50

Marking Systems		
ClearPlot Basic Marker Cards	1492-M3x5 (100/card)	5 cards
ClearMultiprint Markers	1492-MT3X8 (1000/roll)	1 roll

(1) Available in orange as standard, to order other colors add the appropriate suffix to the catalog number listed: Blue =B, Red = RE. Example for a red 2-pole center jumper, the catalog number will be 1492-CJP2-2-RE.

Wiring Diagram



IMPORTANT See page 68 for ferrule selection.

1492-P3

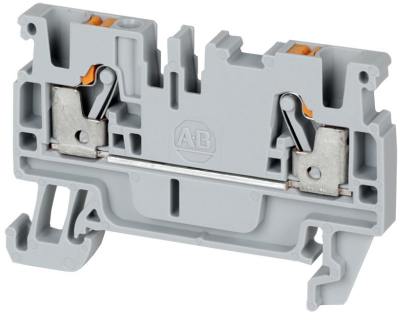

Terminal Blocks—Dimensions (W x H x L): 5.1 x 36.5 x 55 mm

Color	Cat. No.	Pkg. Qty.	Color	Cat. No.	Pkg. Qty.
Grey	1492-P3	100	Green	1492-P3-G	100
Red	1492-P3-RE	100	Yellow	1492-P3-Y	100
Blue	1492-P3-B	100	Orange	1492-P3-OR	100
Black	1492-P3-BL	100	White	1492-P3-W	100

Specifications — Single-level Feed-through Terminal Block

Certifications	UL /CSA	IEC	ATEX
Voltage Rating	600V AC/DC	800V AC/DC	550V AC/DC
Maximum Current	20 A	24 A	21 A
Wire Range (Rated Cross Section)	28...12 AWG	2.5 mm ²	2.5 mm ²
Wire Strip Length	0.4 in. (10 mm)		
Density	59 pcs/ft (196 pcs/m)		
Housing Temperature Range	-76...266°F (-60...130 °C)		

Accessories	Cat. No.	Pkg Qty.
Mounting Rails, End Barriers, End Anchors and Retainers		
Mounting Rail 1 m Symmetrical DIN	Steel	199-DR1 10
	Aluminum	1492-DR5 10
	Hi-Rise (Aluminum)	1492-DR6 2
	Angled (Steel)	1492-DR7 2
End Barriers	Grey	1492-EBP3 50
	Blue	1492-EBP3-B 50
	Yellow	1492-EBP3-Y 50
End Retainer	1492-ERL35	20
End Anchor DIN Rail	Normal Duty	1492-EAJ35 100
	Heavy Duty	1492-EAHJ35 50
	Normal Duty	1492-EAP35 50

Accessories	Cat. No.	Pkg Qty.
Center Jumpers⁽¹⁾		
2-pole	1492-CJP3-2	60
3-pole	1492-CJP3-3	20
4-pole	1492-CJP3-4	
5-pole	1492-CJP3-5	
6-pole	1492-CJP3-6	
7-pole	1492-CJP3-7	
8-pole	1492-CJP3-8	
9-pole	1492-CJP3-9	
10-pole	1492-CJP3-10	
20-pole	1492-CJP3-20	
50-pole	1492-CJP3-50	

Test Plugs			
Test Plugs	Start Test Plug	1492-PTPS	50
	Test Plug	1492-P3TPE	50

Marking Systems		
ClearPlot Basic Marker Cards	1492-MR5X8 (120/card)	5 cards
ClearMultiprint Markers	1492-MT5X8 (800/roll)	1 roll

(1) Available in orange as standard, to order other colors add the appropriate suffix to the catalog number listed: Blue =B, Red = RE. Example for a red 2-pole center jumper, the catalog number will be 1492-CJP3-2-RE.

Wiring Diagram



IMPORTANT See page 69 for ferrule selection.

1492-P3T

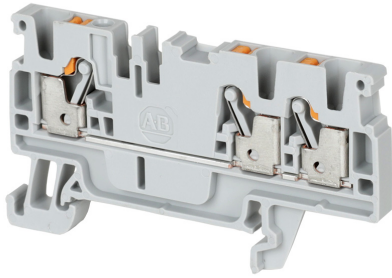

Terminal Blocks—Dimensions (W x H x L): 5.1 x 36.5 x 66.5 mm					
Color	Cat. No.	Pkg. Qty.	Color	Cat. No.	Pkg. Qty.
Grey	1492-P3T	100	Green	1492-P3T-G	100
Red	1492-P3T-RE	100	Yellow	1492-P3T-Y	100
Blue	1492-P3T-B	100	Orange	1492-P3T-OR	100
Black	1492-P3T-BL	100	White	1492-P3T-W	100

Specifications — Single-level Feed-through Terminal Block			
Certifications	UL /CSA	IEC	ATEX
Voltage Rating	600V AC	800V AC	550V AC
Maximum Current	20 A	24 A	21 A
Wire Range (Rated Cross Section)	28...12 AWG	2.5 mm ²	2.5 mm ²
Wire Strip Length	0.4 in. (10 mm)		
Density	59 pcs/ft (196 pcs/m)		
Housing Temperature Range	-76...266°F (-60...130 °C)		

Accessories	Cat. No.	Pkg Qty.	
Mounting Rails, End Barriers, End Anchors and Retainers			
Mounting Rail 1 m Symmetrical DIN	Steel	199-DR1	10
	Aluminum	1492-DR5	10
	Hi-Rise (Aluminum)	1492-DR6	2
	Angled (Steel)	1492-DR7	2
End Barriers	Grey	1492-EBP3T	50
	Blue	1492-EBP3T-B	50
	Yellow	1492-EBP3T-Y	50
End Retainer	1492-ERL35	20	
End Anchor DIN Rail	Normal Duty	1492-EAJ35	100
	Heavy Duty	1492-EAHJ35	50
	Normal Duty	1492-EAP35	50

Accessories	Cat. No.	Pkg Qty.	
Center Jumpers⁽¹⁾			
2-pole	1492-CJP3-2	60	
3-pole	1492-CJP3-3	20	
4-pole	1492-CJP3-4		
5-pole	1492-CJP3-5		
6-pole	1492-CJP3-6		
7-pole	1492-CJP3-7		
8-pole	1492-CJP3-8		
9-pole	1492-CJP3-9		
10-pole	1492-CJP3-10		
20-pole	1492-CJP3-20		
50-pole	1492-CJP3-50		
Test Plugs			
Test Plugs	Start Test Plug	1492-PTPS	50
	Test Plug	1492-P3TPE	50
Marking Systems			
ClearPlot Basic Marker Cards	1492-MR5X8 (120/card)	5 cards	
ClearMultiprint Markers	1492-MT5X8 (800/roll)	1 roll	

(1) Available in orange as standard, to order other colors add the appropriate suffix to the catalog number listed: Blue =B, Red = RE. Example for a red 2-pole center jumper, the catalog number will be 1492-CJP3-2-RE

Wiring Diagram



IMPORTANT See page 69 for ferrule selection.

1492-P3Q

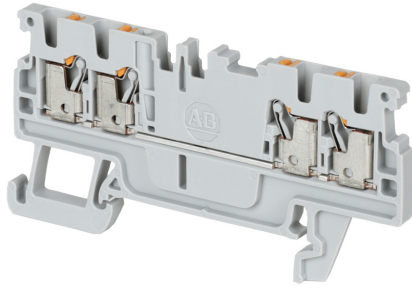

Terminal Blocks—Dimensions (W x H x L): 5.1 x 36.5 x 77.5 mm							
Color	Cat. No.	Pkg. Qty.	Color	Cat. No.	Pkg. Qty.		
	Grey	1492-P3Q	100		Green	1492-P3Q-G	100
	Red	1492-P3Q-RE	100		Yellow	1492-P3Q-Y	100
	Blue	1492-P3Q-B	100		Orange	1492-P3Q-OR	100
	Black	1492-P3Q-BL	100		White	1492-P3Q-W	100

Specifications — Single-level Feed-through Terminal Block			
Certifications	UL /CSA	IEC	ATEX
Voltage Rating	600V AC	800V AC	550V AC
Maximum Current	20 A	24 A	21 A
Wire Range (Rated Cross Section)	28...12 AWG	2.5 mm ²	2.5 mm ²
Wire Strip Length	0.4 in. (10 mm)		
Density	59 pcs/ft (196 pcs/m)		
Housing Temperature Range	-76...266°F (-60...130 °C)		

Accessories	Cat. No.	Pkg Qty.	
Mounting Rails, End Barriers, End Anchors and Retainers			
Mounting Rail 1 m Symmetrical DIN	Steel	199-DR1	10
	Aluminum	1492-DR5	10
	Hi-Rise (Aluminum)	1492-DR6	2
	Angled (Steel)	1492-DR7	2
End Barriers	Grey	1492-EBP3Q	50
	Blue	1492-EBP3Q-B	50
	Yellow	1492-EBP3Q-Y	50
End Retainer	1492-ERL35	20	
End Anchor DIN Rail	Normal Duty	1492-EAJ35	100
	Heavy Duty	1492-EAHJ35	50
	Normal Duty	1492-EAP35	50

Accessories	Cat. No.	Pkg Qty.	
Center Jumpers⁽¹⁾			
2-pole	1492-CJP3-2	60	
3-pole	1492-CJP3-3	20	
4-pole	1492-CJP3-4		
5-pole	1492-CJP3-5		
6-pole	1492-CJP3-6		
7-pole	1492-CJP3-7		
8-pole	1492-CJP3-8		
9-pole	1492-CJP3-9		
10-pole	1492-CJP3-10		
20-pole	1492-CJP3-20		
50-pole	1492-CJP3-50		
Test Plugs			
Test Plugs	Start Test Plug	1492-PTPS	50
	Test Plug	1492-P3TPE	50
Marking Systems			
ClearPlot Basic Marker Cards	1492-MR5X8 (120/card)	5 cards	
ClearMultiprint Markers	1492-MT5X8 (800/roll)	1 roll	

(1) Available in orange as standard, to order other colors add the appropriate suffix to the catalog number listed: Blue =B, Red = RE. Example for a red 2-pole center jumper, the catalog number will be 1492-CJP3-2-RE.

Wiring Diagram



IMPORTANT See page 69 for ferrule selection.

1492-P4

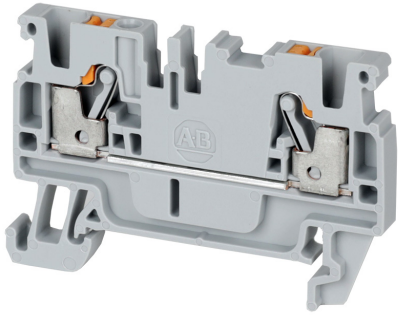

Terminal Blocks—Dimensions (W x H x L): 6.1 x 39.5 x 60 mm							
Color	Cat. No.	Pkg. Qty.	Color	Cat. No.	Pkg. Qty.		
	Grey	1492-P4	100		Green	1492-P4-G	100
	Red	1492-P4-RE	100		Yellow	1492-P4-Y	100
	Blue	1492-P4-B	100		Orange	1492-P4-OR	100
	Black	1492-P4-BL	100		White	1492-P4-W	100

Specifications — Single-level Feed-through Terminal Block			
Certifications	UL /CSA	IEC	ATEX
Voltage Rating	600V AC/DC	800V AC/DC	550V AC/DC
Maximum Current	30 A	32 A	30 A
Wire Range (Rated Cross Section)	26...10 AWG	4 mm ²	4 mm ²
Wire Strip Length	0.47 in. (12 mm)		
Density	49 pcs/ft (163 pcs/m)		
Housing Temperature Range	-76...266°F (-60...130 °C)		

Accessories	Cat. No.	Pkg Qty.	
Mounting Rails, End Barriers, End Anchors and Retainers			
Mounting Rail 1 m Symmetrical DIN	Steel	199-DR1	10
	Aluminum	1492-DR5	10
	Hi-Rise (Aluminum)	1492-DR6	2
	Angled (Steel)	1492-DR7	2
End Barriers	Grey	1492-EBP4	50
	Blue	1492-EBP4-B	50
	Yellow	1492-EBP4-Y	50
End Retainer	1492-ERL35	20	
End Anchor DIN Rail	Normal Duty	1492-EAJ35	100
	Heavy Duty	1492-EAHJ35	50
	Normal Duty	1492-EAP35	50

Accessories	Cat. No.	Pkg Qty.	
Center Jumpers⁽¹⁾			
2-pole	1492-CJP4-2	60	
3-pole	1492-CJP4-3	20	
4-pole	1492-CJP4-4		
5-pole	1492-CJP4-5		
6-pole	1492-CJP4-6		
7-pole	1492-CJP4-7		
8-pole	1492-CJP4-8		
9-pole	1492-CJP4-9		
10-pole	1492-CJP4-10		
50-pole	1492-CJP4-50		5
Test Plugs			
Test Plugs	Start Test Plug	1492-PTPS	50
	Test Plug	1492-P4TPE	50
Marking Systems			
ClearPlot Basic Marker Cards	1492-MR6X8 (120/card)	5 cards	
ClearMultiprint Markers	1492-MT6X8 (600/roll)	1 roll	

(1) Available in orange as standard, to order other colors add the appropriate suffix to the catalog number listed: Blue =B, Red = RE. Example for a red 2-pole center jumper, the catalog number will be 1492-CJP4-4-RE.

Wiring Diagram



IMPORTANT See page 70 for ferrule selection.

1492-P4T

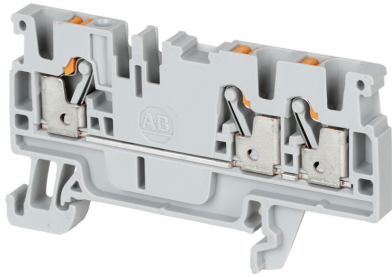

Terminal Blocks—Dimensions (W x H x L): 6.1 x 39.5 x 74 mm							
Color	Cat. No.	Pkg. Qty.	Color	Cat. No.	Pkg. Qty.		
	Grey	1492-P4T	50		Green	1492-P4T-G	50
	Red	1492-P4T-	50		Yellow	1492-P4T-Y	50
	Blue	1492-P4T-B	50		Orange	1492-P4T-OR	50
	Black	1492-P4T-	50		White	1492-P4T-W	50

Specifications — Single-level Feed-through Terminal Block			
Certifications	UL /CSA	IEC	ATEX
Voltage Rating	600V AC/DC	800V AC/DC	550V AC/DC
Maximum Current	30 A	32 A	30 A
Wire Range (Rated Cross Section)	26...10 AWG	4 mm ²	4 mm ²
Wire Strip Length	0.47 in. (12 mm)		
Density	49 pcs/ft (163 pcs/m)		
Housing Temperature Range	-76...266°F (-60...130 °C)		

Accessories	Cat. No.	Pkg Qty.	
Mounting Rails, End Barriers, End Anchors and Retainers			
Mounting Rail 1 m Symmetrical DIN	Steel	199-DR1	10
	Aluminum	1492-DR5	10
	Hi-Rise (Aluminum)	1492-DR6	2
	Angled (Steel)	1492-DR7	2
End Barriers	Grey	1492-EBP4T	20
	Blue	1492-EBP4T-B	20
	Yellow	1492-EBP4T-Y	50
End Retainer	1492-ERL35	20	
End Anchor DIN Rail	Normal Duty	1492-EAJ35	100
	Heavy Duty	1492-EAHJ35	50
	Normal Duty	1492-EAP35	50

Accessories	Cat. No.	Pkg Qty.	
Center Jumpers⁽¹⁾			
2-pole	1492-CJP4-2	60	
3-pole	1492-CJP4-3	20	
4-pole	1492-CJP4-4		
5-pole	1492-CJP4-5		
6-pole	1492-CJP4-6		
7-pole	1492-CJP4-7		
8-pole	1492-CJP4-8		
9-pole	1492-CJP4-9		
10-pole	1492-CJP4-10		
50-pole	1492-CJP4-50		5
Test Plugs			
Test Plugs	Start Test Plug	1492-PTPS	50
	Test Plug	1492-P4TPE	50
Marking Systems			
ClearPlot Basic Marker Cards	1492-MR6X8 (120/card)	5 cards	
ClearMultiprint Markers	1492-MT6X8 (600/roll)	1 roll	

(1) Available in orange as standard, to order other colors add the appropriate suffix to the catalog number listed: Blue =B, Red =RE. Example for a red 2-pole center jumper, the catalog number will be 1492-CJP4-2-RE.

Wiring Diagram



IMPORTANT See page 70 for ferrule selection.

1492-P4Q

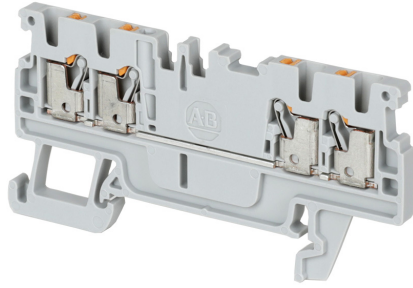

Terminal Blocks—Dimensions (W x H x L): 6.1 x 39.5 x 87.5 mm							
Color	Cat. No.	Pkg. Qty.	Color	Cat. No.	Pkg. Qty.		
	Grey	1492-P4Q	50		Green	1492-P4Q-G	50
	Red	1492-P4Q-RE	50		Yellow	1492-P4Q-Y	50
	Blue	1492-P4Q-B	50		Orange	1492-P4Q-OR	50
	Black	1492-P4Q-BL	50		White	1492-P4Q-W	50

Specifications — Single-level Feed-through Terminal Block			
Certifications	UL /CSA	IEC	ATEX
Voltage Rating	600V AC/DC	800V AC/DC	550V AC/DC
Maximum Current	30 A	32 A	30 A
Wire Range (Rated Cross Section)	26...10 AWG	4 mm ²	4 mm ²
Wire Strip Length	0.47 in. (12 mm)		
Density	49 pcs/ft (163 pcs/m)		
Housing Temperature Range	-76...266°F (-60...130 °C)		

Accessories	Cat. No.	Pkg Qty.	
Mounting Rails, End Barriers, End Anchors and Retainers			
Mounting Rail 1 m Symmetrical DIN	Steel	199-DR1	10
	Aluminum	1492-DR5	10
	Hi-Rise (Aluminum)	1492-DR6	2
	Angled (Steel)	1492-DR7	2
End Barriers	Grey	1492-EBP4Q	20
	Blue	1492-EBP4Q-B	20
	Yellow	1492-EBP4Q-Y	50
End Retainer	1492-ERL35	20	
End Anchor DIN Rail	Normal Duty	1492-EAJ35	100
	Heavy Duty	1492-EAHJ35	50
	Normal Duty	1492-EAP35	50

Accessories	Cat. No.	Pkg Qty.	
Center Jumpers⁽¹⁾			
2-pole	1492-CJP4-2	60	
3-pole	1492-CJP4-3	20	
4-pole	1492-CJP4-4		
5-pole	1492-CJP4-5		
6-pole	1492-CJP4-6		
7-pole	1492-CJP4-7		
8-pole	1492-CJP4-8		
9-pole	1492-CJP4-9		
10-pole	1492-CJP4-10		
50-pole	1492-CJP4-50		5
Test Plugs			
Test Plugs	Start Test Plug	1492-PTPS	50
	Test Plug	1492-P4TPE	50
Marking Systems			
ClearPlot Basic Marker Cards	1492-MR6X8 (120/card)	5 cards	
ClearMultiprint Markers	1492-MT6X8 (600/roll)	1 roll	

(1) Available in orange as standard, to order other colors add the appropriate suffix to the catalog number listed: Blue =B, Red = RE. Example for a red 2-pole center jumper, the catalog number will be 1492-CJP4-2-RE.

Wiring Diagram



IMPORTANT See page 70 for ferrule selection.

1492-P6

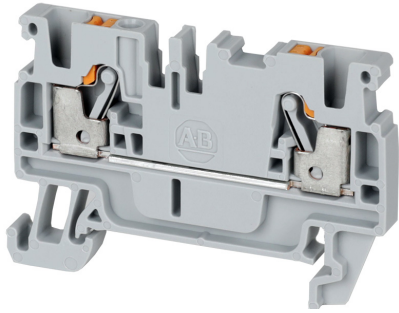

Terminal Blocks—Dimensions (W x H x L): 8.1 x 45.5 x 66.5 mm

Color	Cat. No.	Pkg. Qty.	Color	Cat. No.	Pkg. Qty.
Grey	1492-P6	50	Green	1492-P6-G	50
Red	1492-P6-RE	50	Yellow	1492-P6-Y	50
Blue	1492-P6-B	50	Orange	1492-P6-OR	50
Black	1492-P6-BL	50	White	1492-P6-W	50

Specifications — Single-level Feed-through Terminal Block

Certifications	UL /CSA	IEC	ATEX
Voltage Rating	600V AC/DC	800V AC/DC	550V AC/DC
Maximum Current	38 A	41 A	36 A
Wire Range (Rated Cross Section)	22...8 AWG	6 mm ²	6 mm ²
Wire Strip Length	0.47 in. (12 mm)		
Density	37 pcs/ft (123 pcs/m)		
Housing Temperature Range	-76...266°F (-60...130 °C)		

Accessories	Cat. No.	Pkg Qty.
Center Jumpers⁽¹⁾		
2-pole	1492-CJP6-2	60
3-pole	1492-CJP6-3	20
4-pole	1492-CJP6-4	60
Test Plugs		
Start Test Plug	1492-PTPS	50
Test Plug	1492-P6TPE	50
Marking Systems		
ClearPlot Basic Marker Cards	1492-MR6X8 (120/card)	5 cards
ClearMultiprint Markers	1492-MT8X8 (500/roll)	1 roll

Mounting Rails, End Barriers, End Anchors and Retainers			
Mounting Rail 1 m Symmetrical DIN	Steel	199-DR1	10
	Aluminum	1492-DR5	10
	Hi-Rise (Aluminum)	1492-DR6	2
	Angled (Steel)	1492-DR7	2
End Barriers	Grey	1492-EBP6	50
	Blue	1492-EBP6-B	50
	Yellow	1492-EBP6-Y	50
End Retainer		1492-ERL35	20
End Anchor DIN Rail	Normal Duty	1492-EAJ35	100
	Heavy Duty	1492-EAHJ35	50
	Normal Duty	1492-EAP35	50

Accessories	Cat. No.	Pkg Qty.
Center Jumpers⁽¹⁾		
2-pole	1492-CJP6-2	60
3-pole	1492-CJP6-3	20
4-pole	1492-CJP6-4	60
Test Plugs		
Start Test Plug	1492-PTPS	50
Test Plug	1492-P6TPE	50
Marking Systems		
ClearPlot Basic Marker Cards	1492-MR6X8 (120/card)	5 cards
ClearMultiprint Markers	1492-MT8X8 (500/roll)	1 roll

(1) Available in orange as standard, to order in blue, add B to the catalog number listed: Example for a blue 2-pole center jumper, the catalog number will be 1492-CJP6-2-B.

Wiring Diagram



IMPORTANT See page 71 for ferrule selection.

1492-P6T

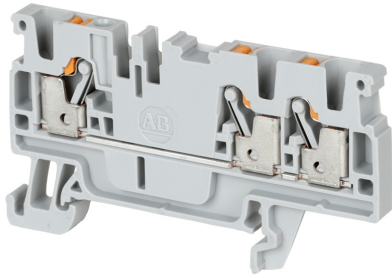

Terminal Blocks — Dimensions (W x H x L): 8.1 x 45.5 x 84.5 mm							
Color	Cat. No.	Pkg. Qty.	Color	Cat. No.	Pkg. Qty.		
	Grey	1492-P6T	50		Green	1492-P6T-G	50
	Red	1492-P6T-RE	50		Yellow	1492-P6T-Y	50
	Blue	1492-P6T-B	50		Orange	1492-P6T-OR	50
	Black	1492-P6T-BL	50		White	1492-P6T-W	50

Specifications — Single-level Feed-through Terminal Block			
Certifications	UL /CSA	IEC	ATEX
Voltage Rating	600V AC/DC	800V AC/DC	550V AC/DC
Maximum Current	38 A	41 A	36 A
Wire Range (Rated Cross Section)	22...8 AWG	6 mm ²	6 mm ²
Wire Strip Length	0.47 in. (12 mm)		
Density	37 pcs/ft (123 pcs/m)		
Housing Temperature Range	-76...266 °F (-60...130 °C)		

Accessories	Cat. No.	Pkg Qty.
Center Jumpers⁽¹⁾		
2-pole	1492-CJP6-2	60
3-pole	1492-CJP6-3	20
4-pole	1492-CJP6-4	60
Test Plugs		
Test Plugs	Start Test Plug	1492-PTPS
	Test Plug	1492-P6TPE
Marking Systems		
ClearPlot Basic Marker Cards	1492-MR6X8 (120/card)	5 cards
ClearMultiprint Markers	1492-MT8X8 (500/roll)	1 roll

Mounting Rails, End Barriers, End Anchors and Retainers			
Mounting Rail 1 m Symmetrical DIN	Steel	199-DR1	10
	Aluminum	1492-DR5	10
	Hi-Rise (Aluminum)	1492-DR6	2
	Angled (Steel)	1492-DR7	2
End Barriers	Grey	1492-EBP6T	50
	Blue	1492-EBP6T-B	20
	Yellow	1492-EBP6T-Y	20
End Retainer		1492-ERL35	20
End Anchor DIN Rail	Normal Duty	1492-EAJ35	100
	Heavy Duty	1492-EAHJ35	50
	Normal Duty	1492-EAP35	50

Accessories	Cat. No.	Pkg Qty.
Center Jumpers⁽¹⁾		
2-pole	1492-CJP6-2	60
3-pole	1492-CJP6-3	20
4-pole	1492-CJP6-4	60
Test Plugs		
Test Plugs	Start Test Plug	1492-PTPS
	Test Plug	1492-P6TPE
Marking Systems		
ClearPlot Basic Marker Cards	1492-MR6X8 (120/card)	5 cards
ClearMultiprint Markers	1492-MT8X8 (500/roll)	1 roll

(1) Available in orange as standard, to order in blue, add B to the catalog number listed: Example for a blue 2-pole center jumper, the catalog number will be 1492-CJP6-2-B.

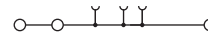

Wiring Diagram

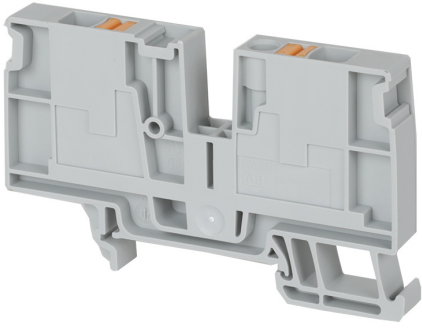

IMPORTANT See page 71 for ferrule selection.

1492-P6D



Terminal Blocks — Dimensions (W x H x L): 9 x 45.5 x 77 mm					
Color	Cat. No.	Pkg. Qty.	Color	Cat. No.	Pkg. Qty.
 Grey	1492-P6D	20	 Blue	1492-P6D-B	20

Specifications — Single-level Feed-through Distribution Terminal Block			
Certifications	UL / CSA	IEC	ATEX
Voltage Rating	600V AC/DC	800V AC/DC	550V AC/DC
Maximum Current	38 A	41 A	33 A
Wire Range (Rated Cross Section)	22...8 AWG	6 mm ²	6 mm ²
Wire Strip Length	0.47 in. (12 mm)		
Density	34 pcs/ft (111 pcs/m)		
Housing Temperature Range	-76...266 °F (-60...130 °C)		

Accessories		Cat. No.	Pkg Qty.
Mounting Rails, End Barriers, End Anchors and Retainers			
Mounting Rail 1 m Symmetrical DIN	Steel	199-DR1	10
	Aluminum	1492-DR5	10
	Hi-Rise	1492-DR6	2
	Angled (Steel)	1492-DR7	2
End Barriers	Included as part of 1492-P6D or 1492-P6D-B		
End Retainer	1492-ERL35	20	
End Anchor DIN Rail	Normal Duty	1492-EAJ35	100
	Heavy Duty	1492-EAHJ35	50
	Normal Duty	1492-EAP35	50

Accessories	Cat. No.	Pkg Qty.
Center Jumpers⁽¹⁾		
2-pole	1492-CJP2-2	20
3-pole	1492-CJP2-3	
4-pole	1492-CJP2-4	
5-pole	1492-CJP2-5	
6-pole	1492-CJP2-6	
7-pole	1492-CJP2-7	
8-pole	1492-CJP2-8	
9-pole	1492-CJP2-9	
10-pole	1492-CJP2-10	
20-pole	1492-CJP2-20	
50-pole	1492-CJP2-50	

Test Plugs			
Test Plugs	Start Test Plug	1492-PTPS	50
	Test Plug	1492-P6TPE	50

Marking Systems		
ClearPlot Basic Marker Cards	1492-MR6X8 (120/card)	5 cards
ClearMultiprint Markers	1492-MT8X8 (500/roll)	1 roll

(1) Available in orange as standard, to order other colors add the appropriate suffix to the catalog number listed: Blue =B, Red = RE. Example for a red 2-pole center jumper, the catalog number will be 1492-CJP2-2-RE.

Wiring Diagram





IMPORTANT See page 71 for ferrule selection.

Single-level, Feed-through Grounding Terminal Blocks

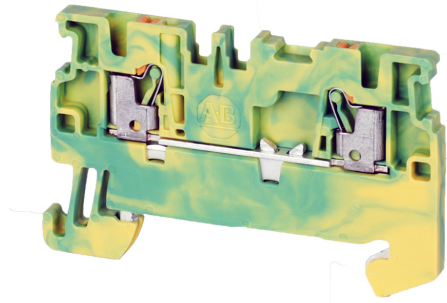
1492-PG2



Terminal Blocks—Dimensions (W x H x L): 3.5 x 33.5 x 55 mm			
Color	Cat. No.	Pkg. Qty.	
 Green/Yellow	1492-PG2	50	

Specifications — Single-level Feed-through Grounding Terminal Block			
Certifications	 /CSA	IEC	ATEX
Voltage Rating	300V AC/DC	500V AC/DC	550V AC/DC
Wire Range (Rated Cross Section)	26...14 AWG	1.5 mm ²	1.5 mm ²
Wire Strip Length	0.31 in. (8 mm)		
Density	87 pcs/ft (285 pcs/m)		
Housing Temperature Range	-76...266°F (-60...130 °C)		

Accessories		Cat. No.	Pkg. Qty.
Mounting Rails, End Barriers, End Anchors and Retainers			
Mounting Rail 1 m Symmetrical DIN	Steel	199-DR1	10
	Aluminum	1492-DR5	10
	Hi-Rise (Aluminum)	1492-DR6	2
	Angled (Steel)	1492-DR7	2
End Barriers	Grey	1492-EBP2	50
	Blue	1492-EBP2-B	50
	Yellow	1492-EBP2-Y	50
End Retainer		1492-ERL35	20
End Anchor DIN Rail	Normal Duty	1492-EAJ35	100
	Heavy Duty	1492-EAHJ35	50
	Normal Duty	1492-EAP35	50

Accessories		Cat. No.	Pkg. Qty.
Center Jumper⁽¹⁾			
2-pole	Orange	1492-CJP2-2	20
3-pole		1492-CJP2-3	
4-pole		1492-CJP2-4	
5-pole		1492-CJP2-5	
6-pole		1492-CJP2-6	
7-pole		1492-CJP2-7	
8-pole		1492-CJP2-8	
9-pole		1492-CJP2-9	
10-pole		1492-CJP2-10	
20-pole		1492-CJP2-20	
50-pole		1492-CJP2-50	

Test Plugs			
Test Plugs	Start Test Plug	1492-PTPS	50
	Test Plug	1492-P2TPE	50

Marking Systems		
ClearPlot Basic Marker Cards	1492-M3x5 (100/card)	5 cards
ClearMultiprint Markers	1492-MT3X8 (1000/roll)	1 roll

(1) Available in orange as standard, to order other colors add the appropriate suffix to the catalog number listed: Blue =B, Red = RE. Example for a red 2-pole center jumper, the catalog number will be 1492-CJP2-2-RE.

Wiring Diagram

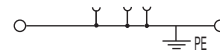

IMPORTANT See page 68 for ferrule selection.

1492-PG2T

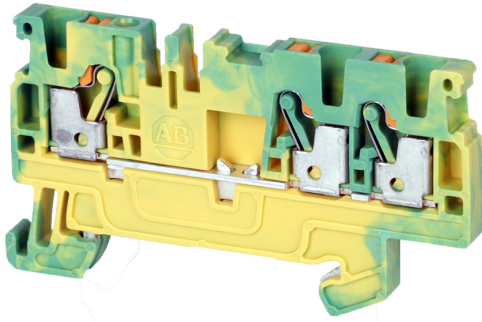

Terminal Blocks—Dimensions (W x H x L): 3.5 x 33.5 x 61.5 mm			
Color	Cat. No.	Pkg. Qty.	
 Green/Yellow	1492-PG2T	50	

Specifications — Single-level Feed-through Grounding Terminal Block			
Certifications	 /CSA	IEC	ATEX
Voltage Rating	300V AC/DC	500V AC/DC	500V AC/DC
Wire Range (Rated Cross Section)	26...14 AWG	1.5 mm ²	1.5 mm ²
Wire Strip Length	0.31 in. (8 mm)		
Density	87 pcs/ft (285 pcs/m)		
Housing Temperature Range	-76...266°F (-60...130 °C)		

Accessories	Cat. No.	Pkg. Qty.	
Mounting Rails, End Barriers, End Anchors and Retainers			
Mounting Rail 1 m Symmetrical DIN	Steel	199-DR1	10
	Aluminum	1492-DR5	10
	Hi-Rise (Aluminum)	1492-DR6	2
	Angled (Steel)	1492-DR7	2
End Barriers	Grey	1492-EBP2T	50
	Blue	1492-EBP2T-B	50
	Yellow	1492-EBP2T-Y	50
End Retainer	1492-ERL35	20	
End Anchor DIN Rail	Normal Duty	1492-EAJ35	100
	Heavy Duty	1492-EAHJ35	50
	Normal Duty	1492-EAP35	50

Accessories	Cat. No.	Pkg. Qty.
Center Jumpers⁽¹⁾		
2-pole	1492-CJP2-2	20
3-pole	1492-CJP2-3	
4-pole	1492-CJP2-4	
5-pole	1492-CJP2-5	
6-pole	1492-CJP2-6	
7-pole	1492-CJP2-7	
8-pole	1492-CJP2-8	
9-pole	1492-CJP2-9	
10-pole	1492-CJP2-10	
20-pole	1492-CJP2-20	
50-pole	1492-CJP2-50	

Test Plugs			
Test Plugs	Start Test Plug	1492-PTPS	50
	Test Plug	1492-P2TPE	50

Marking Systems		
ClearPlot Basic Marker Cards	1492-M3x5 (100/card)	5 cards
ClearMultiPrint Markers	1492-MT3X8 (1000/roll)	1 roll

(1) Available in orange as standard, to order other colors add the appropriate suffix to the catalog number listed: Blue =B, Red = RE. Example for a red 2-pole center jumper, the catalog number will be 1492-CJP2-2-RE.

Wiring Diagram



IMPORTANT See page 68 for ferrule selection.

1492-PG2Q

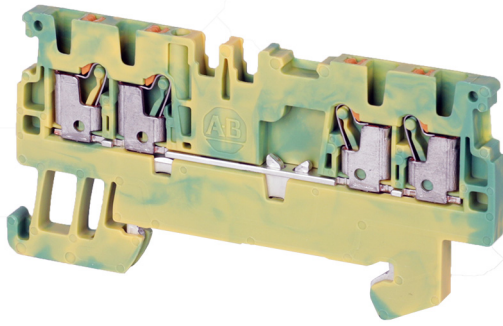

Terminal Blocks—Dimensions (W x H x L): 3.5 x 33.5 x 67.5 mm			
Color	Cat. No.	Pkg. Qty.	
 Green/Yellow	1492-PG2Q	50	

Specifications — Single-level Feed-through Grounding Terminal Block			
Certifications	 /CSA	IEC	ATEX
Voltage Rating	300V AC/DC	500V AC/DC	550V AC/DC
Wire Range (Rated Cross Section)	26...14 AWG	1.5 mm ²	1.5 mm ²
Wire Strip Length	0.31 in. (8 mm)		
Density	87 pcs/ft (285 pcs/m)		
Housing Temperature Range	-76...266°F (-60...130 °C)		

Accessories	Cat. No.	Pkg. Qty.	
Mounting Rails, End Barriers, End Anchors and Retainers			
Mounting Rail 1 m Symmetrical DIN	Steel	199-DR1	10
	Aluminum	1492-DR5	10
	Hi-Rise (Aluminum)	1492-DR6	2
	Angled (Steel)	1492-DR7	2
End Barriers	Grey	1492-EBP2Q	50
	Blue	1492-EBP2Q-B	50
	Yellow	1492-EBP2Q-Y	50
End Retainer	1492-ERL35	20	
End Anchor DIN Rail	Normal Duty	1492-EAJ35	100
	Heavy Duty	1492-EAHJ35	50
	Normal Duty	1492-EAP35	50

Accessories	Cat. No.	Pkg. Qty.
Center Jumpers⁽¹⁾		
2-pole	1492-CJP2-2	20
3-pole	1492-CJP2-3	
4-pole	1492-CJP2-4	
5-pole	1492-CJP2-5	
6-pole	1492-CJP2-6	
7-pole	1492-CJP2-7	
8-pole	1492-CJP2-8	
9-pole	1492-CJP2-9	
10-pole	1492-CJP2-10	
20-pole	1492-CJP2-20	

Test Plugs			
Test Plugs	Start Test Plug	1492-PTPS	50
	Test Plug	1492-P2TPE	50

Marking Systems			
ClearPlot Basic Marker Cards	1492-M3x5 (100/card)	5 cards	
ClearMultiprint Markers	1492-MT3X8 (1000/roll)	1 roll	

(1) Available in orange as standard, to order other colors add the appropriate suffix to the catalog number listed: Blue =B, Red = RE. Example for a red 2-pole center jumper, the catalog number will be 1492-CJP2-2-RE.

Wiring Diagram



IMPORTANT See page 68 for ferrule selection.

1492-PG3

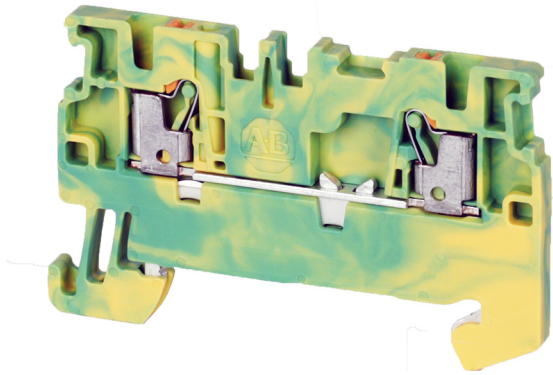

Terminal Blocks—Dimensions (W x H x L): 5.1 x 36.5 x 55 mm

Color	Cat. No.	Pkg. Qty.
 Green/Yellow	1492-PG3	50

Specifications — Single-level Feed-through Grounding Terminal Block

Certifications	 /CSA	IEC	ATEX
Voltage Rating	600V AC/DC	800V AC/DC	550V AC/DC
Wire Range (Rated Cross Section)	28...12 AWG	2.5 mm ²	2.5 mm ²
Wire Strip Length	0.4 in. (10 mm)		
Density	59 pcs/ft (196 pcs/m)		
Housing Temperature Range	-76...266°F (-60...130 °C)		

Accessories	Cat. No.	Pkg Qty.
-------------	----------	----------

Mounting Rails, End Barriers, End Anchors and Retainers

Mounting Rail 1 m Symmetrical DIN	Steel	199-DR1	10
	Aluminum	1492-DR5	10
	Hi-Rise (Aluminum)	1492-DR6	2
	Angled (Steel)	1492-DR7	2
End Barriers	Grey	1492-EBP3	50
	Blue	1492-EBP3-B	50
	Yellow	1492-EBP3-Y	50
End Retainer		1492-ERL35	20
End Anchor DIN Rail	Normal Duty	1492-EAJ35	100
	Heavy Duty	1492-EAHJ35	50
	Normal Duty	1492-EAP35	50

Accessories	Cat. No.	Pkg Qty.
Center Jumpers⁽¹⁾		
2-pole	1492-CJP3-2	60
3-pole	1492-CJP3-3	20
4-pole	1492-CJP3-4	
5-pole	1492-CJP3-5	
6-pole	1492-CJP3-6	
7-pole	1492-CJP3-7	
8-pole	1492-CJP3-8	
9-pole	1492-CJP3-9	
10-pole	1492-CJP3-10	
20-pole	1492-CJP3-20	
50-pole	1492-CJP3-50	

Test Plugs			
Test Plugs	Start Test Plug	1492-PTPS	50
	Test Plug	1492-P3TPE	50

Marking Systems			
ClearPlot Basic Marker Cards	1492-MR5X8 (120/card)	5 cards	
ClearMultiPrint Markers	1492-MT5X8 (800/roll)	1 roll	

(1) Available in orange as standard, to order other colors add the appropriate suffix to the catalog number listed: Blue =B, Red = RE. Example for a red 2-pole center jumper, the catalog number will be 1492-CJP3-2-RE.

Wiring Diagram



IMPORTANT See page 69 for ferrule selection.

1492-PG3T

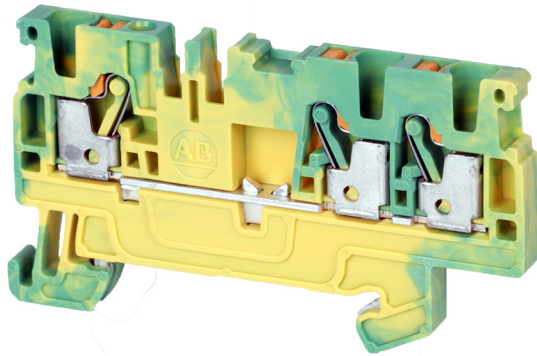

Terminal Blocks—Dimensions (W x H x L): 5.1 x 36.5 x 66.5 mm

Color	Cat. No.	Pkg. Qty.
 Green/Yellow	1492-PG3T	50

Specifications — Single-level Feed-through Grounding Terminal Block

Certifications	 /CSA	IEC	ATEX
Voltage Rating	600V AC/DC	800V AC/DC	550V AC/DC
Wire Range (Rated Cross Section)	28...12 AWG	2.5 mm ²	2.5 mm ²
Wire Strip Length	0.4 in. (10 mm)		
Density	59 pcs/ft (196 pcs/m)		
Housing Temperature Range	-76...266°F (-60...130 °C)		

Accessories	Cat. No.	Pkg Qty.
-------------	----------	----------

Mounting Rails, End Barriers, End Anchors and Retainers

Mounting Rail 1 m Symmetrical DIN	Steel	199-DR1	10
	Aluminum	1492-DR5	10
	Hi-Rise (Aluminum)	1492-DR6	2
	Angled (Steel)	1492-DR7	2
End Barriers	Grey	1492-EBP3T	50
	Blue	1492-EBP3T-B	50
	Yellow	1492-EBP3T-Y	50
End Retainer		1492-ERL35	20
End Anchor DIN Rail	Normal Duty	1492-EAJ35	100
	Heavy Duty	1492-EAHJ35	50
	Normal Duty	1492-EAP35	50

Accessories	Cat. No.	Pkg Qty.
Center Jumpers⁽¹⁾		
2-pole	1492-CJP3-2	60
3-pole	1492-CJP3-3	20
4-pole	1492-CJP3-4	
5-pole	1492-CJP3-5	
6-pole	1492-CJP3-6	
7-pole	1492-CJP3-7	
8-pole	1492-CJP3-8	
9-pole	1492-CJP3-9	
10-pole	1492-CJP3-10	
20-pole	1492-CJP3-20	
50-pole	1492-CJP3-50	

Test Plugs			
Test Plugs	Start Test Plug	1492-PTPS	50
	Test Plug	1492-P3TPE	50

Marking Systems			
ClearPlot Basic Marker Cards	1492-MR5X8 (120/card)	5 cards	
ClearMultiprint Markers	1492-MT5X8 (800/roll)	1 roll	

(1) Available in orange as standard, to order other colors add the appropriate suffix to the catalog number listed: Blue =B, Red = RE. Example for a red 2-pole center jumper, the catalog number will be 1492-CJP3-2-RE.

Wiring Diagram

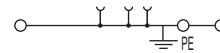

IMPORTANT See page 69 for ferrule selection.

1492-PG3Q

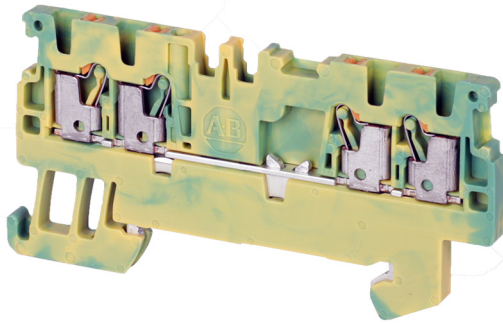

Terminal Blocks—Dimensions (W x H x L): 5.1 x 36.5 x 77.5 mm		
Color	Cat. No.	Pkg. Qty.
 Green/Yellow	1492-PG3Q	50

Specifications — Single-level Feed-through Grounding Terminal Block			
Certifications	UL /CSA	IEC	ATEX
Voltage Rating	600V AC/DC	800V AC/DC	550V AC/DC
Wire Range (Rated Cross Section)	26...12 AWG	2.5 mm ²	2.5 mm ²
Wire Strip Length	0.4 in. (10 mm)		
Density	59 pcs/ft (196 pcs/m)		
Housing Temperature Range	-76...266°F (-60...130 °C)		

Accessories	Cat. No.	Pkg Qty.	
Mounting Rails, End Barriers, End Anchors and Retainers			
Mounting Rail 1 m Symmetrical DIN	Steel	199-DR1	10
	Aluminum	1492-DR5	10
	Hi-Rise (Aluminum)	1492-DR6	2
	Angled (Steel)	1492-DR7	2
End Barriers	Grey	1492-EBP3Q	50
	Blue	1492-EBP3Q-B	50
	Yellow	1492-EBP3Q-Y	50
End Retainer	1492-ERL35	20	
End Anchor DIN Rail	Normal Duty	1492-EAJ35	100
	Heavy Duty	1492-EAHJ35	50
	Normal Duty	1492-EAP35	50

Accessories	Cat. No.	Pkg Qty.
Center Jumpers⁽¹⁾		
2-pole	1492-CJP3-2	60
3-pole	1492-CJP3-3	20
4-pole	1492-CJP3-4	
5-pole	1492-CJP3-5	
6-pole	1492-CJP3-6	
7-pole	1492-CJP3-7	
8-pole	1492-CJP3-8	
9-pole	1492-CJP3-9	
10-pole	1492-CJP3-10	
20-pole	1492-CJP3-20	
50-pole	1492-CJP3-50	

Test Plugs			
Test Plugs	Start Test Plug	1492-PTPS	50
	Test Plug	1492-P3TPE	50

Marking Systems		
ClearPlot Basic Marker Cards	1492-MR5X8 (120/card)	5 cards
ClearMultiprint Markers	1492-MT5X8 (800/roll)	1 roll

(1) Available in orange as standard, to order other colors add the appropriate suffix to the catalog number listed: Blue =B, Red = RE. Example for a red 2-pole center jumper, the catalog number will be 1492-CJP3-2-RE.

Wiring Diagram



IMPORTANT See page 69 for ferrule selection.

1492-PG4

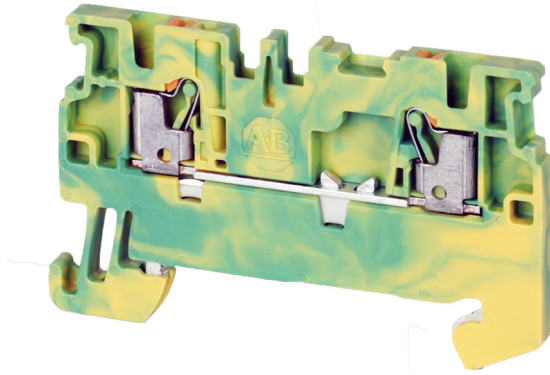

Terminal Blocks—Dimensions (W x H x L): 6.1 x 39.5 x 60 mm			
Color		Cat. No.	Pkg. Qty.
	Green/Yellow	1492-PG4	50

Specifications — Single-level Feed-through Grounding Terminal Block			
Certifications	/CSA	IEC	ATEX
Voltage Rating	600V AC/DC	800V AC/DC	550V AC/DC
Wire Range (Rated Cross Section)	26...10 AWG	4 mm ²	4 mm ²
Wire Strip Length	0.47 in. (12 mm)		
Density	49 pcs/ft (163 pcs/m)		
Housing Temperature Range	-76...266°F (-60...130 °C)		

Accessories		Cat. No.	Pkg Qty.
Mounting Rails, End Barriers, End Anchors and Retainers			
Mounting Rail 1 m Symmetrical DIN	Steel	199-DR1	10
	Aluminum	1492-DR5	10
	Hi-Rise (Aluminum)	1492-DR6	2
	Angled (Steel)	1492-DR7	2
End Barriers	Grey	1492-EBP4	50
	Blue	1492-EBP4-B	50
	Yellow	1492-EBP4-Y	50
End Retainer		1492-ERL35	20
End Anchor DIN Rail	Normal Duty	1492-EAJ35	100
	Heavy Duty	1492-EAHJ35	50
	Normal Duty	1492-EAP35	50

Accessories		Cat. No.	Pkg Qty.
Center Jumpers⁽¹⁾			
2-pole	Orange	1492-CJP4-2	60
3-pole		1492-CJP4-3	20
4-pole		1492-CJP4-4	
5-pole		1492-CJP4-5	
6-pole		1492-CJP4-6	
7-pole		1492-CJP4-7	
8-pole		1492-CJP4-8	
9-pole		1492-CJP4-9	
10-pole		1492-CJP4-10	
50-pole		1492-CJP4-50	5

Test Plugs			
Test Plugs	Start Test Plug	1492-PTPS	50
	Test Plug	1492-P4TPE	50

Marking Systems			
ClearPlot Basic Marker Cards	1492-MR6X8 (120/card)	5 cards	
ClearMultiprint Markers	1492-MT6X8 (600/roll)	1 roll	

(1) Available in orange as standard, to order other colors add the appropriate suffix to the catalog number listed: Blue =B, Red = RE. Example for a red 2-pole center jumper, the catalog number will be 1492-CJP4-2-RE.

Wiring Diagram



IMPORTANT See page [70](#) for ferrule selection.

1492-PG4T

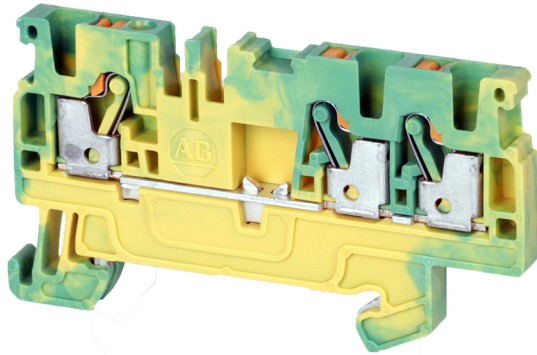

Terminal Blocks—Dimensions (W x H x L): 6.1 x 39.5 x 74 mm			
Color		Cat. No.	Pkg. Qty.
	Green/Yellow	1492-PG4T	50

Specifications — Single-level Feed-through Grounding Terminal Block			
Certifications	UL /CSA	IEC	ATEX
Voltage Rating	600V AC/DC	800V AC/DC	550V AC/DC
Wire Range (Rated Cross Section)	26...10 AWG	4 mm ²	4 mm ²
Wire Strip Length	0.47 in. (12 mm)		
Density	49 pcs/ft (163 pcs/m)		
Housing Temperature Range	-76...266°F (-60...130 °C)		

Accessories		Cat. No.	Pkg Qty.
Mounting Rails, End Barriers, End Anchors and Retainers			
Mounting Rail 1 m Symmetrical DIN	Steel	199-DR1	10
	Aluminum	1492-DR5	10
	Hi-Rise (Aluminum)	1492-DR6	2
	Angled (Steel)	1492-DR7	2
End Barriers	Grey	1492-EBP4T	20
	Blue	1492-EBP4T-B	20
	Yellow	1492-EBP4T-Y	50
End Retainer		1492-ERL35	20
End Anchor DIN Rail	Normal Duty	1492-EAJ35	100
	Heavy Duty	1492-EAHJ35	50
	Normal Duty	1492-EAP35	50

Accessories		Cat. No.	Pkg Qty.
Center Jumpers⁽¹⁾			
2-pole	Orange	1492-CJP4-2	60
3-pole		1492-CJP4-3	20
4-pole		1492-CJP4-4	
5-pole		1492-CJP4-5	
6-pole		1492-CJP4-6	
7-pole		1492-CJP4-7	
8-pole		1492-CJP4-8	
9-pole		1492-CJP4-9	
10-pole		1492-CJP4-10	
50-pole			1492-CJP4-50

Test Plugs			
Test Plugs	Start Test Plug	1492-PTPS	50
	Test Plug	1492-P4TPE	50

Marking Systems			
ClearPlot Basic Marker Cards	1492-MR6X8 (120/card)	5 cards	
ClearMultiprint Markers	1492-MT6X8 (600/roll)	1 roll	

(1) Available in orange as standard, to order other colors add the appropriate suffix to the catalog number listed: Blue =B, Red = RE. Example for a red 2-pole center jumper, the catalog number will be 1492-CJP4-2-RE.

Wiring Diagram

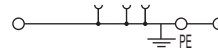

IMPORTANT See page 70 for ferrule selection.

1492-PG4Q

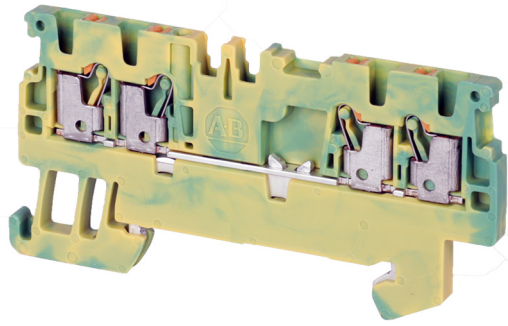

Terminal Blocks—Dimensions (W x H x L): 6.1 x 39.5 x 87.5 mm			
Color		Cat. No.	Pkg. Qty.
	Green/Yellow	1492-PG4Q	50

Specifications — Single-level Feed-through Grounding Terminal Block			
Certifications	UL / CSA	IEC	ATEX
Voltage Rating	600V AC/DC	800V AC/DC	550V AC/DC
Wire Range (Rated Cross Section)	26...10 AWG	4 mm ²	4 mm ²
Wire Strip Length	0.47 in. (12 mm)		
Density	49 pcs/ft (163 pcs/m)		
Housing Temperature Range	-76...266°F (-60...130 °C)		

Accessories		Cat. No.	Pkg Qty.
Mounting Rails, End Barriers, End Anchors and Retainers			
Mounting Rail 1 m Symmetrical DIN	Steel	199-DR1	10
	Aluminum	1492-DR5	10
	Hi-Rise (Aluminum)	1492-DR6	2
	Angled (Steel)	1492-DR7	2
End Barriers	Grey	1492-EBP4Q	20
	Blue	1492-EBP4Q-B	20
	Yellow	1492-EBP4Q-Y	50
End Retainer		1492-ERL35	20
End Anchor DIN Rail	Normal Duty	1492-EAJ35	100
	Heavy Duty	1492-EAHJ35	50
	Normal Duty	1492-EAP35	50

Accessories		Cat. No.	Pkg Qty.
Center Jumpers⁽¹⁾			
2-pole	Orange	1492-CJP4-2	60
3-pole		1492-CJP4-3	20
4-pole		1492-CJP4-4	
5-pole		1492-CJP4-5	
6-pole		1492-CJP4-6	
7-pole		1492-CJP4-7	
8-pole		1492-CJP4-8	
9-pole		1492-CJP4-9	
10-pole		1492-CJP4-10	
50-pole		1492-CJP4-50	

Test Plugs			
Test Plugs	Start Test Plug	1492-PTPS	50
	Test Plug	1492-P4TPE	50

Marking Systems			
ClearPlot Basic Marker Cards	1492-MR6X8 (120/card)	5 cards	
ClearMultiprint Markers	1492-MT6X8 (600/roll)	1 roll	

(1) Available in orange as standard, to order other colors add the appropriate suffix to the catalog number listed: Blue =B, Red = RE. Example for a red 2-pole center jumper, the catalog number will be 1492-CJP4-2-RE.

Wiring Diagram



IMPORTANT See page 70 for ferrule selection.

1492-PG6

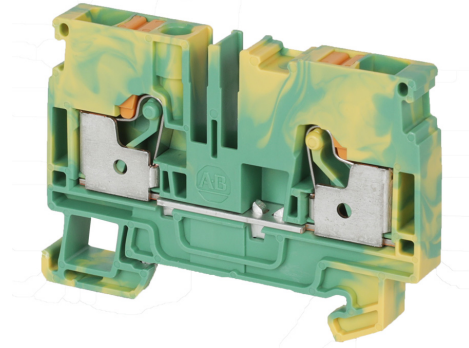

Terminal Blocks—Dimensions (W x H x L): 8.1x 45.5 x 66.5 mm

Color	Cat. No.	Pkg. Qty.
 Green/Yellow	1492-PG6	50

Specifications — Single-level Feed-through Grounding Terminal Block

Certifications	 /CSA	IEC	ATEX
Voltage Rating	600V AC/DC	800V AC	550V AC
Wire Range (Rated Cross Section)	22...8 AWG	6 mm ²	6 mm ²
Wire Strip Length	0.47 in (12 mm)		
Density	37 pcs/ft (123 pcs/m)		
Housing Temperature Range	-76...266°F (-60...130 °C)		

Accessories	Cat. No.	Pkg. Qty.
-------------	----------	-----------

Mounting Rails, End Barriers, End Anchors and Retainers

Mounting Rail 1 m Symmetrical DIN	Steel	199-DR1	10
	Aluminum	1492-DR5	10
	Hi-Rise (Aluminum)	1492-DR6	2
	Angled (Steel)	1492-DR7	2
End Barriers	Grey	1492-EBP6	50
	Blue	1492-EBP6-B	50
	Yellow	1492-EBP6-Y	50
End Retainer		1492-ERL35	20
End Anchor DIN Rail	Normal Duty	1492-EAJ35	100
	Heavy Duty	1492-EAHJ35	50
	Normal Duty	1492-EAP35	50

Accessories	Cat. No.	Pkg. Qty.	
Center Jumpers⁽¹⁾			
2-pole	Orange	1492-CJP6-2	60
3-pole		1492-CJP6-3	20
4-pole		1492-CJP6-4	60
Test Plugs			
Test Plugs	Start Test Plug	1492-PTPS	50
	Test Plug	1492-P6TPE	50
Marking Systems			
ClearPlot Basic Marker Cards	1492-MR6X8 (120/card)	5 cards	
ClearMultiprint Markers	1492-MT8X8 (500/roll)	1 roll	

(1) Available in orange as standard, to order in blue, add -B suffix to the catalog number listed. Example for a blue 2-pole center jumper, the catalog number will be 1492-CJP6-2-B.

Wiring Diagram



IMPORTANT See page 71 for ferrule selection.

1492-PG6T

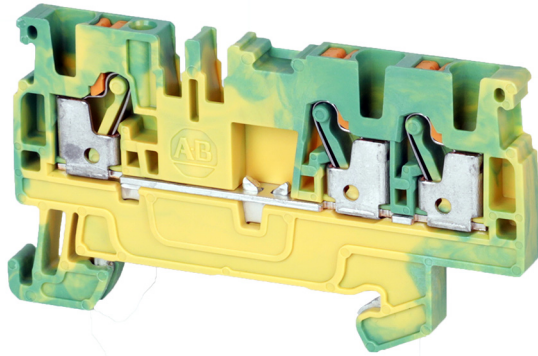

Terminal Blocks—Dimensions (W x H x L): 8.1x 45.5 x 84.5 mm			
Color		Cat. No.	Pkg. Qty.
	Green/Yellow	1492-PG6T	50

Specifications — Single-level Feed-through Grounding Terminal Block			
Certifications	/CSA	IEC	ATEX
Voltage Rating	600V AC/DC	800V AC	550V AC
Wire Range (Rated Cross Section)	22...8 AWG	6 mm ²	6 mm ²
Wire Strip Length	0.47 in (12 mm)		
Density	37 pcs/ft (123 pcs/m)		
Housing Temperature Range	-76...266°F (-60...130 °C)		

Accessories		Cat. No.	Pkg. Qty.
Mounting Rails, End Barriers, End Anchors and Retainers			
Mounting Rail 1 m Symmetrical DIN	Steel	199-DR1	10
	Aluminum	1492-DR5	10
	Hi-Rise (Aluminum)	1492-DR6	2
	Angled (Steel)	1492-DR7	2
End Barriers	Grey	1492-EBP6T	50
	Blue	1492-EBP6T-B	20
	Yellow	1492-EBP6T-Y	20
End Retainer		1492-ERL35	20
End Anchor DIN Rail	Normal Duty	1492-EAJ35	100
	Heavy Duty	1492-EAHJ35	50
	Normal Duty	1492-EAP35	50

Accessories		Cat. No.	Pkg. Qty.
Center Jumpers⁽¹⁾			
2-pole	Orange	1492-CJP6-2	60
3-pole		1492-CJP6-3	20
4-pole		1492-CJP6-4	60
Test Plugs			
Test Plugs	Start Test Plug	1492-PTPS	50
	Test Plug	1492-P6TPE	50
Marking Systems			
ClearPlot Basic Marker Cards		1492-MR6X8 (120/card)	5 cards
ClearMultiprint Markers		1492-MT8X8 (500/roll)	1 roll

(1) Available in orange as standard, to order in blue, add -B suffix to the catalog number listed. Example for a blue 2-pole center jumper, the catalog number will be 1492-CJP6-2-B.

Wiring Diagram



IMPORTANT See page [71](#) for ferrule selection.

Double-level, Feed-through Terminal Blocks

1492-PD3

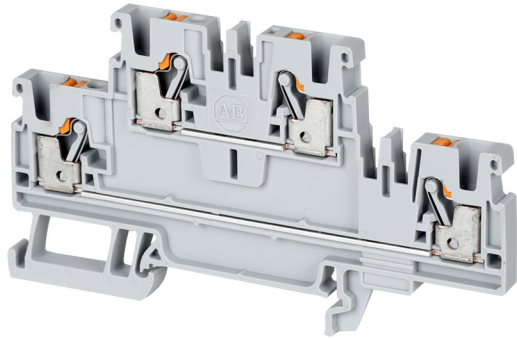

Terminal Blocks—Dimensions (W x H x L): 5.1 x 50.5 x 90 mm

Color	Cat. No.	Pkg. Qty.	Color	Cat. No.	Pkg. Qty.
Grey	1492-PD3	50	Green	1492-PD3-G	50
Red	1492-PD3-RE	50	Yellow	1492-PD3-Y	50
Blue	1492-PD3-B	50	Orange	1492-PD3-OR	50
Black	1492-PD3-BL	50	White	1492-PD3-W	50

Specifications — Double-level Feed-through Terminal Block

Certifications	UL / CSA	IEC	ATEX
Voltage Rating	600V AC/DC	800V AC/DC	550V AC/DC
Maximum Current	20 A	24 A	21 A
Wire Range (Rated Cross Section)	28...12 AWG	2.5 mm ²	2.5mm ²
Wire Strip Length	0.4 in. (10 mm)		
Density	59 pcs/ft (196 pcs/m)		
Housing Temperature Range	-76...266°F (-60...130 °C)		

Accessories	Cat. No.	Pkg Qty.	
Mounting Rails, End Barriers, End Anchors and Retainers			
Mounting Rail 1 m Symmetrical DIN	Steel	199-DR1	10
	Aluminum	1492-DR5	10
	Hi-Rise (Aluminum)	1492-DR6	2
	Angled (Steel)	1492-DR7	2
End Barriers	Grey	1492-EBPD3	20
	Blue	1492-EBPD3-B	20
	Yellow	1492-EBPD3-Y	20
End Retainer	1492-ERL35	20	
End Anchor DIN Rail	Normal Duty	1492-EAJ35	100
	Heavy Duty	1492-EAHJ35	50
	Normal Duty	1492-EAP35	50

Accessories	Cat. No.	Pkg Qty.
Center Jumpers⁽¹⁾		
2-pole	1492-CJP3-2	60
3-pole	1492-CJP3-3	20
4-pole	1492-CJP3-4	
5-pole	1492-CJP3-5	
6-pole	1492-CJP3-6	
7-pole	1492-CJP3-7	
8-pole	1492-CJP3-8	
9-pole	1492-CJP3-9	
10-pole	1492-CJP3-10	
20-pole	1492-CJP3-20	
50-pole	1492-CJP3-50	

Test Plugs			
Test Plugs	Start Test Plug	1492-PTPS	50
	Test Plug	1492-P3TPE	50

Marking Systems		
ClearPlot Basic Marker Cards	1492-MR5X8 (120/card)	5 cards
ClearMultiprint Markers	1492-MT5X8 (800/roll)	1 roll

(1) Available in orange as standard, to order other colors add the appropriate suffix to the catalog number listed: Blue =B, Red = RE. Example for a red 2-pole center jumper, the catalog number will be 1492-CJP3-2-RE.

Wiring Diagram

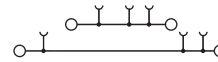

IMPORTANT See [page 69](#) for ferrule selection.

1492-PD3C

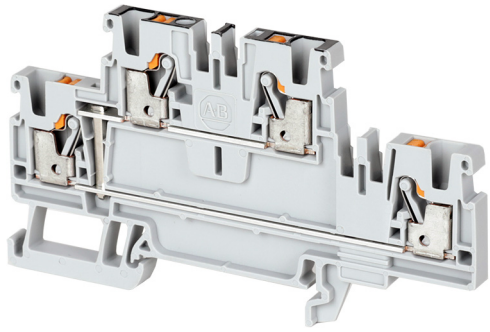

Terminal Blocks—Dimensions (W x H x L): 5.1 x 50.5 x 90 mm

Color	Cat. No.	Pkg. Qty.	Color	Cat. No.	Pkg. Qty.
Grey	1492-PD3C	50	Green	1492-PD3C-G	50
Red	1492-PD3C-RE	50	Yellow	1492-PD3C-Y	50
Blue	1492-PD3C-B	50	Orange	1492-PD3C-OR	50
Black	1492-PD3C-BL	50	White	1492-PD3C-W	50

Specifications — Double-level Feed-through Terminal Block

Certifications	UL /CSA	IEC	ATEX
Voltage Rating	600V AC/DC	800V AC/DC	550V AC/DC
Maximum Current	20 A	24 A	21 A
Wire Range (Rated Cross Section)	28...12 AWG	2.5 mm ²	2.5mm ²
Wire Strip Length	0.4 in. (10 mm)		
Density	59 pcs/ft (196 pcs/m)		
Housing Temperature Range	-76...266°F (-60...130 °C)		

Accessories	Cat. No.	Pkg Qty.	
Mounting Rails, End Barriers, End Anchors and Retainers			
Mounting Rail 1 m Symmetrical DIN	Steel	199-DR1	10
	Aluminum	1492-DR5	10
	Hi-Rise (Aluminum)	1492-DR6	2
	Angled (Steel)	1492-DR7	2
End Barriers	Grey	1492-EBPD3	20
	Blue	1492-EBPD3-B	20
	Yellow	1492-EBPD3-Y	20
End Retainer		1492-ERL35	20
End Anchor DIN Rail	Normal Duty	1492-EAJ35	100
	Heavy Duty	1492-EAHJ35	50
	Normal Duty	1492-EAP35	50

Accessories	Cat. No.	Pkg Qty.
Center Jumpers⁽¹⁾		
2-pole	1492-CJP3-2	60
3-pole	1492-CJP3-3	20
4-pole	1492-CJP3-4	
5-pole	1492-CJP3-5	
6-pole	1492-CJP3-6	
7-pole	1492-CJP3-7	
8-pole	1492-CJP3-8	
9-pole	1492-CJP3-9	
10-pole	1492-CJP3-10	
20-pole	1492-CJP3-20	
50-pole	1492-CJP3-50	

Test Plugs

Test Plugs	Start Test Plug	1492-PTPS	50
	Test Plug	1492-P3TPE	50

Marking Systems

ClearPlot Basic Marker Cards	1492-MR5X8 (120/card)	5 cards
ClearMultiprint Markers	1492-MT5X8 (800/roll)	1 roll

(1) Available in orange as standard, to order other colors add the appropriate suffix to the catalog number listed: Blue =B, Red = RE. Example for a red 2-pole center jumper, the catalog number will be 1492-CJP3-2-RE.

Wiring Diagram

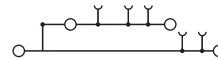

IMPORTANT See [page 69](#) for ferrule selection.

Double-level, Feed-through Grounding Terminal Blocks

1492-PDG3

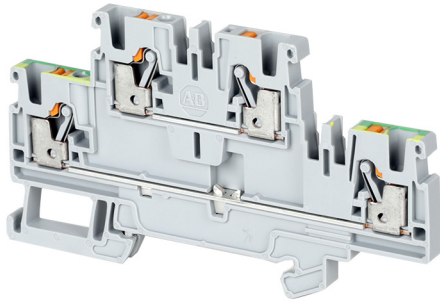

Terminal Blocks—Dimensions (W x H x L): 5.1x 50.5 x 90 mm			
Color		Cat. No.	Pkg. Qty.
	Grey	1492-PDG3	50

Specifications — Double-level Feed-through Grounding Terminal Block			
Certifications	UL /CSA	IEC	ATEX
Voltage Rating	600V AC/DC	800V AC/DC	550V AC/DC
Maximum Current	20 A	24 A	21 A
Wire Range (Rated Cross Section)	28...12 AWG	2.5 mm ²	2.5 mm ²
Wire Strip Length	0.4 in. (10 mm)		
Density	59 pcs/ft (196 pcs/m)		
Housing Temperature Range	-76...266°F (-60...130 °C)		

Accessories		Cat. No.	Pkg. Qty.
Mounting Rails, End Barriers, End Anchors and Retainers			
Mounting Rail 1 m Symmetrical DIN	Steel	199-DR1	10
	Aluminum	1492-DR5	10
	Hi-Rise (Aluminum)	1492-DR6	2
	Angled (Steel)	1492-DR7	2
End Barriers	Grey	1492-EBPD3	20
	Blue	1492-EBPD3-B	20
	Yellow	1492-EBPD3-Y	20
End Retainer		1492-ERL35	20
End Anchor DIN Rail	Normal Duty	1492-EAJ35	100
	Heavy Duty	1492-EAHJ35	50
	Normal Duty	1492-EAP35	50

Accessories		Cat. No.	Pkg. Qty.
Center Jumpers⁽¹⁾			
2-pole	Orange	1492-CJP3-2	60
3-pole		1492-CJP3-3	20
4-pole		1492-CJP3-4	
5-pole		1492-CJP3-5	
6-pole		1492-CJP3-6	
7-pole		1492-CJP3-7	
8-pole		1492-CJP3-8	
9-pole		1492-CJP3-9	
10-pole		1492-CJP3-10	
20-pole		1492-CJP3-20	
50-pole		1492-CJP3-50	

Test Plugs			
Test Plugs	Start Test Plug	1492-PTPS	50
	Test Plug	1492-P3TPE	50

Marking Systems			
ClearPlot Basic Marker Cards	1492-MRSX8 (120/card)	5 cards	
ClearMultiprint Markers	1492-MT5X8 (800/roll)	1 roll	

(1) Available in orange as standard, to order other colors add the appropriate suffix to the catalog number listed: Blue =B, Red = RE. Example for a red 2-pole center jumper, the catalog number will be 1492-CJP3-2-RE.

Wiring Diagram

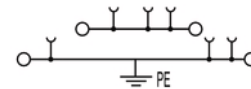

IMPORTANT See [page 69](#) for ferrule selection.

1492-PDG3C

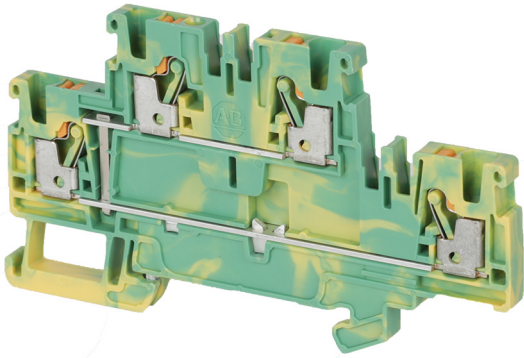

Terminal Blocks—Dimensions (W x H x L): 5.1x 50.5 x 90 mm			
Color	Cat. No.	Pkg. Qty.	
 Green/Yellow	1492-PDG3C	50	

Specifications — Double-level Feed-through Grounding Terminal Block			
Certifications	UL /CSA	IEC	ATEX
Voltage Rating	600V AC/DC	800V AC/DC	550V AC/DC
Wire Range (Rated Cross Section)	28...12 AWG	2.5 mm ²	2.5 mm ²
Wire Strip Length	0.4 in. (10 mm)		
Density	59 pcs/ft (196 pcs/m)		
Housing Temperature Range	-76...266°F (-60...130 °C)		

Accessories		Cat. No.	Pkg. Qty.
Mounting Rails, End Barriers, End Anchors and Retainers			
Mounting Rail 1 m Symmetrical DIN	Steel	199-DR1	10
	Aluminum	1492-DR5	10
	Hi-Rise (Aluminum)	1492-DR6	2
	Angled (Steel)	1492-DR7	2
End Barriers	Grey	1492-EBPD3	20
	Blue	1492-EBPD3-B	20
	Yellow	1492-EBPD3-Y	20
End Retainer		1492-ERL35	20
End Anchor DIN Rail	Normal Duty	1492-EAJ35	100
	Heavy Duty	1492-EAHJ35	50
	Normal Duty	1492-EAP35	50

Accessories		Cat. No.	Pkg. Qty.
Center Jumpers⁽¹⁾			
2-pole	Orange	1492-CJP3-2	60
3-pole		1492-CJP3-3	20
4-pole		1492-CJP3-4	
5-pole		1492-CJP3-5	
6-pole		1492-CJP3-6	
7-pole		1492-CJP3-7	
8-pole		1492-CJP3-8	
9-pole		1492-CJP3-9	
10-pole		1492-CJP3-10	
20-pole		1492-CJP3-20	
50-pole		1492-CJP3-50	

Test Plugs			
Test Plugs	Start Test Plug	1492-PTPS	50
	Test Plug	1492-P3TPE	50

Marking Systems			
ClearPlot Basic Marker Cards	1492-MR5X8 (120/card)	5 cards	
ClearMultiprint Markers	1492-MT5X8 (800/roll)	1 roll	

(1) Available in orange as standard, to order other colors add the appropriate suffix to the catalog number listed: Blue =B, Red = RE. Example for a red 2-pole center jumper, the catalog number will be 1492-CJP2-2-RE.

Wiring Diagram

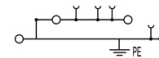



IMPORTANT See [page 69](#) for ferrule selection.

Three-level, Feed-through Terminal Blocks

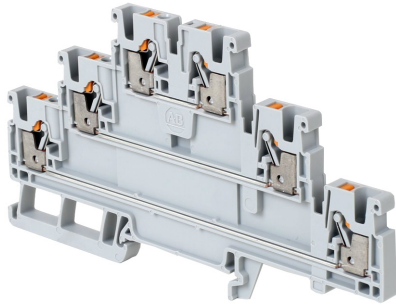
1492-PT3



Terminal Blocks—Dimensions (W x H x L): 5.1 x 64.5 x 116mm					
Color	Cat. No.	Pkg. Qty.	Color	Cat. No.	Pkg. Qty.
 Grey	1492-PT3	50	 Blue	1492-PT3-B	50

Specifications — Single-level Feed-through Terminal Block			
Certifications	UL / CSA	IEC	ATEX
Voltage Rating	600V AC/DC	800V AC/DC	550V AC/DC
Maximum Current	20 A	24 A	19 A
Wire Range (Rated Cross Section)	28...12 AWG	2.5 mm ²	2.5 mm ²
Wire Strip Length	0.4 in. (10 mm)		
Density	59 pcs/ft (196 pcs/m)		
Housing Temperature Range	-76...266°F (-60...130 °C)		

Accessories	Cat. No.	Pkg Qty.	
Mounting Rails, End Barriers, End Anchors and Retainers			
Mounting Rail 1 m Symmetrical DIN	Steel	199-DR1	10
	Aluminum	1492-DR5	10
	Hi-Rise (Aluminum)	1492-DR6	2
	Angled (Steel)	1492-DR7	2
End Barriers	Grey	1492-EBPT3	20
	Blue	1492-EBPT3-B	20
End Retainer	1492-ERL35	20	
End Anchor DIN Rail	Normal Duty	1492-EAJ35	100
	Heavy Duty	1492-EAHJ35	50
	Normal Duty	1492-EAP35	50

Accessories	Cat. No.	Pkg Qty.
Center Jumpers⁽¹⁾		
2-pole	1492-CJP3-2	60
3-pole	1492-CJP3-3	20
4-pole	1492-CJP3-4	
5-pole	1492-CJP3-5	
6-pole	1492-CJP3-6	
7-pole	1492-CJP3-7	
8-pole	1492-CJP3-8	
9-pole	1492-CJP3-9	
10-pole	1492-CJP3-10	
20-pole	1492-CJP3-20	
50-pole	1492-CJP3-50	

Test Plugs			
Test Plugs	Start Test Plug	1492-PTPS	50
	Test Plug	1492-P3TPE	50

Marking Systems		
ClearPlot Basic Marker Cards	1492-MR5X8 (120/card)	5 cards
ClearMultiprint Markers	1492-MT5X8 (800/roll)	1 roll

(1) Available in orange as standard, to order other colors add the appropriate suffix to the catalog number listed: Blue =B, Red = RE. Example for a red 2-pole center jumper, the catalog number will be 1492-CJP3-2-RE.

Wiring Diagram

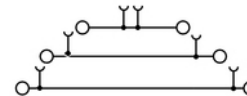

IMPORTANT See [page 69](#) for ferrule selection.

1492-PT3C

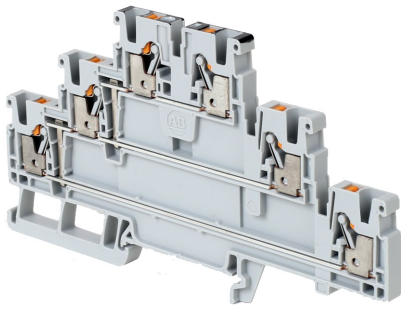

Terminal Blocks—Dimensions (W x H x L): 5.1 x 64.5 x 116mm					
Color	Cat. No.	Pkg. Qty.	Color	Cat. No.	Pkg. Qty.
Grey	1492-PT3C	50	Blue	1492-PT3C-B	50

Specifications — Single-level Feed-through Terminal Block				
Certifications	UL / CSA	IEC	ATEX	
Voltage Rating	600V AC/DC	800V AC/DC	550V AC/DC	
Maximum Current	20 A	24 A	19 A	
Wire Range (Rated Cross Section)	28...12 AWG	2.5 mm ²	2.5 mm ²	
Wire Strip Length	0.4 in. (10 mm)			
Density	59 pcs/ft (196 pcs/m)			
Housing Temperature Range	-76...266°F (-60...130 °C)			

Accessories		Cat. No.	Pkg Qty.
Mounting Rails, End Barriers, End Anchors and Retainers			
Mounting Rail 1 m Symmetrical DIN	Steel	199-DR1	10
	Aluminum	1492-DR5	10
	Hi-Rise (Aluminum)	1492-DR6	2
	Angled (Steel)	1492-DR7	2
End Barriers	Grey	1492-EBPT3	20
	Blue	1492-EBPT3-B	20
End Retainer		1492-ERL35	20
End Anchor DIN Rail	Normal Duty	1492-EAJ35	100
	Heavy Duty	1492-EAHJ35	50
	Normal Duty	1492-EAP35	50

Accessories	Cat. No.	Pkg Qty.
Center Jumpers⁽¹⁾		
2-pole	1492-CJP3-2	60
3-pole	1492-CJP3-3	20
4-pole	1492-CJP3-4	
5-pole	1492-CJP3-5	
6-pole	1492-CJP3-6	
7-pole	1492-CJP3-7	
8-pole	1492-CJP3-8	
9-pole	1492-CJP3-9	
10-pole	1492-CJP3-10	
20-pole	1492-CJP3-20	
50-pole	1492-CJP3-50	

Test Plugs			
Test Plugs	Start Test Plug	1492-PTPS	50
	Test Plug	1492-P3TPE	50

Marking Systems		
ClearPlot Basic Marker Cards	1492-MR5X8 (120/card)	5 cards
ClearMultiprint Markers	1492-MT5X8 (800/roll)	1 roll

(1) Available in orange as standard, to order other colors add the appropriate suffix to the catalog number listed: Blue =B, Red = RE. Example for a red 2-pole center jumper, the catalog number will be 1492-CJP3-2-RE.

Wiring Diagram

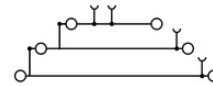

IMPORTANT See [page 69](#) for ferrule selection.

Three-level, Feed-through Grounding Terminal Blocks

1492-PTG3

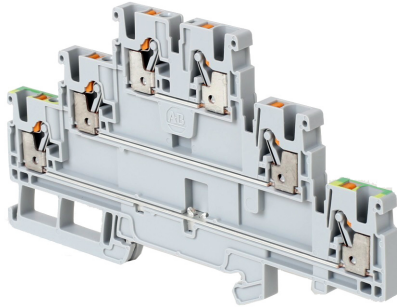

Terminal Blocks—Dimensions (W x H x L): 5.1 x 64.5 x 116 mm			
Color		Cat. No.	Pkg. Qty.
	Grey	1492-PTG3	50

Specifications — Single-level Feed-through Terminal Block			
Certifications	UL / CSA	IEC	ATEX
Voltage Rating	600V AC/DC	800V AC/DC	550V AC/DC
Maximum Current	20 A	24 A	19 A
Wire Range (Rated Cross Section)	28...12 AWG	2.5 mm ²	2.5 mm ²
Wire Strip Length	0.4 in. (10 mm)		
Density	59 pcs/ft (196 pcs/m)		
Housing Temperature Range	-76...266°F (-60...130 °C)		

Accessories		Cat. No.	Pkg Qty.
Mounting Rails, End Barriers, End Anchors and Retainers			
Mounting Rail 1 m Symmetrical DIN	Steel	199-DR1	10
	Aluminum	1492-DR5	10
	Hi-Rise (Aluminum)	1492-DR6	2
	Angled (Steel)	1492-DR7	2
End Barriers	Grey	1492-EBPT3	20
	Blue	1492-EBPT3-B	20
End Retainer		1492-ERL35	20
End Anchor DIN Rail	Normal Duty	1492-EAJ35	100
	Heavy Duty	1492-EAHJ35	50
	Normal Duty	1492-EAP35	50

Accessories		Cat. No.	Pkg Qty.
Center Jumpers⁽¹⁾			
2-pole	Orange	1492-CJP3-2	60
3-pole		1492-CJP3-3	20
4-pole		1492-CJP3-4	
5-pole		1492-CJP3-5	
6-pole		1492-CJP3-6	
7-pole		1492-CJP3-7	
8-pole		1492-CJP3-8	
9-pole		1492-CJP3-9	
10-pole		1492-CJP3-10	
20-pole		1492-CJP3-20	
50-pole		1492-CJP3-50	

Test Plugs			
Test Plugs	Start Test Plug	1492-PTPS	50
	Test Plug	1492-P3TPE	50

Marking Systems		
ClearPlot Basic Marker Cards	1492-MR5X8 (120/card)	5 cards
ClearMultiprint Markers	1492-MT5X8 (800/roll)	1 roll

(1) Available in orange as standard, to order other colors add the appropriate suffix to the catalog number listed: Blue =B, Red = RE. Example for a red 2-pole center jumper, the catalog number will be 1492-CJP3-2-RE.

Wiring Diagram

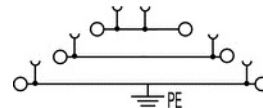

IMPORTANT See [page 69](#) for ferrule selection.

1492-PTG3C

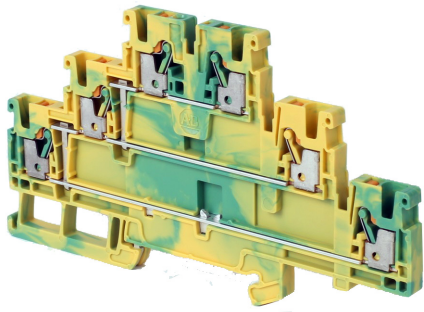

Terminal Blocks—Dimensions (W x H x L): 5.1 x 64.5 x 116 mm			
Color		Cat. No.	Pkg. Qty.
	Green/Yellow	1492-PTG3C	50

Specifications — Single-level Feed-through Terminal Block			
Certifications		IEC	ATEX
Voltage Rating	600V AC/DC	800V AC/DC	550V AC/DC
Maximum Current	20 A	24 A	19 A
Wire Range (Rated Cross Section)	28...12 AWG	2.5 mm ²	2.5 mm ²
Wire Strip Length	0.4 in. (10 mm)		
Density	59 pcs/ft (196 pcs/m)		
Housing Temperature Range	-76...266°F (-60...130 °C)		

Accessories		Cat. No.	Pkg Qty.
Mounting Rails, End Barriers, End Anchors and Retainers			
Mounting Rail 1 m Symmetrical DIN	Steel	199-DR1	10
	Aluminum	1492-DR5	10
	Hi-Rise (Aluminum)	1492-DR6	2
	Angled (Steel)	1492-DR7	2
End Barriers	Grey	1492-EBPT3	20
	Blue	1492-EBPT3-B	20
End Retainer		1492-ERL35	20
End Anchor DIN Rail	Normal Duty	1492-EAJ35	100
	Heavy Duty	1492-EAHJ35	50
	Normal Duty	1492-EAP35	50

Accessories		Cat. No.	Pkg Qty.
Center Jumpers⁽¹⁾			
2-pole	Orange	1492-CJP3-2	60
3-pole		1492-CJP3-3	20
4-pole		1492-CJP3-4	
5-pole		1492-CJP3-5	
6-pole		1492-CJP3-6	
7-pole		1492-CJP3-7	
8-pole		1492-CJP3-8	
9-pole		1492-CJP3-9	
10-pole		1492-CJP3-10	
20-pole		1492-CJP3-20	
50-pole	1492-CJP3-50		

Test Plugs			
Test Plugs	Start Test Plug	1492-PTPS	50
	Test Plug	1492-P3TPE	50

Marking Systems			
ClearPlot Basic Marker Cards	1492-MR5X8 (120/card)	5 cards	
ClearMultiPrint Markers	1492-MT5X8 (800/roll)	1 roll	

(1) Available in orange as standard, to order other colors add the appropriate suffix to the catalog number listed: Blue =B, Red = RE. Example for a red 2-pole center jumper, the catalog number will be 1492-CJP3-2-RE.

Wiring Diagram

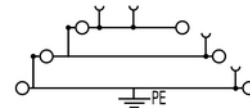

IMPORTANT See [page 69](#) for ferrule selection.

Four-level Feed-through Terminal Blocks

1492-PQ3

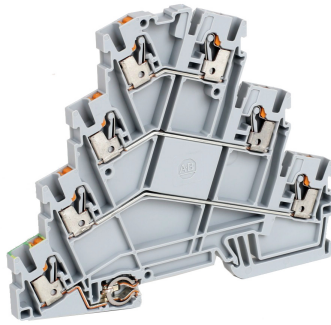

Terminal Blocks—Dimensions (W x H x L): 5.1 x 88.5 x 107 mm

Color		Cat. No.	Pkg. Qty.
■	Grey	1492-PQ3	50
■	Grey	1492-PQ3-800	50

Specifications — Single-level Feed-through Terminal Block

Certifications	UL /CSA	IEC	ATEX
Voltage Rating, -PQ3	600V AC/DC	690V AC/DC	440V AC/DC
Voltage Rating, -PQ3-800	600V AC/DC	800V AC/DC	550V AC/DC
Maximum Current	20 A	24 A	19 A
Wire Range (Rated Cross Section)	28...12 AWG	2.5 mm ²	2.5 mm ²
Wire Strip Length	0.4 in. (10 mm)		
Density	59 pcs/ft (196 pcs/m)		
Housing Temperature Range	-76...266°F (-60...130 °C)		

Accessories	Cat. No.	Pkg Qty.
-------------	----------	----------

Mounting Rails, End Barriers, End Anchors and Retainers

Mounting Rail 1 m Symmetrical DIN	Steel	199-DR1	10
	Aluminum	1492-DR5	10
	Hi-Rise (Aluminum)	1492-DR6	2
	Angled (Steel)	1492-DR7	2
End Barriers	Grey	1492-EBPQ3	20
		Included as part of 1492-PQ3-800	
End Retainer		1492-ERL35	20
End Anchor DIN Rail	Normal Duty	1492-EAJ35	100
	Heavy Duty	1492-EAHJ35	50
	Normal Duty	1492-EAP35	50

Accessories	Cat. No.	Pkg Qty.
Center Jumpers⁽¹⁾		
2-pole	1492-CJP3-2	60
3-pole	1492-CJP3-3	20
4-pole	1492-CJP3-4	
5-pole	1492-CJP3-5	
6-pole	1492-CJP3-6	
7-pole	1492-CJP3-7	
8-pole	1492-CJP3-8	
9-pole	1492-CJP3-9	
10-pole	1492-CJP3-10	
20-pole	1492-CJP3-20	
50-pole	1492-CJP3-50	

Test Plugs			
Test Plugs	Start Test Plug	1492-PTPS	50
	Test Plug	1492-P3TPE	50

Marking Systems			
ClearPlot Basic Marker Cards	1492-MR5X8 (120/card)	5 cards	
ClearMultiprint Markers	1492-MT5X8 (800/roll)	1 roll	

(1) Available in orange as standard, to order other colors add the appropriate suffix to the catalog number listed: Blue =B, Red = RE. Example for a red 2-pole center jumper, the catalog number will be 1492-CJP3-2-RE.

Wiring Diagram

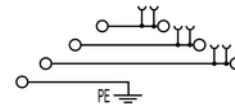

IMPORTANT See [page 69](#) for ferrule selection.

Disconnect Terminal Blocks

1492-PKD3

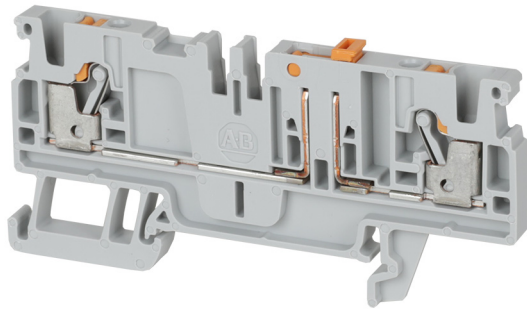

Terminal Blocks—Dimensions (W x H x L): 5.1 x 37.65 x 77.5 mm					
Color	Cat. No.	Pkg. Qty.	Color	Cat. No.	Pkg. Qty.
Grey	1492-PKD3	50	Blue	1492-PKD3-B	50

Specifications — Single-level Disconnect Terminal Block			
Certifications	UL / CSA	IEC	ATEX
Voltage Rating	300V AC/DC	500V AC/DC	400V AC/DC
Maximum Current	20 A	20 A	20 A
Wire Range (Rated Cross Section)	28...12 AWG	2.5 mm ²	2.5 mm ²
Wire Strip Length	0.4 in. (10 mm)		
Density	59 pcs/ft (196 pcs/m)		
Housing Temperature Range	-76...266°F (-60...130°C)		

Accessories	Cat. No.	Pkg. Qty.	
Mounting Rails, End Barriers, End Anchors and Retainers			
Mounting Rail 1 m Symmetrical DIN	Steel	199-DR1	10
	Aluminum	1492-DR5	10
	Hi-Rise (Aluminum)	1492-DR6	2
	Angled (Steel)	1492-DR7	2
End Barriers	Grey	1492-EBP3Q	50
	Blue	1492-EBP3Q-B	50
	Yellow	1492-EBP3Q-Y	50
End Retainer	1492-ERL35	20	
End Anchor DIN Rail	Normal Duty	1492-EAJ35	100
	Heavy Duty	1492-EAHJ35	50
	Normal Duty	1492-EAP35	50

Accessories	Cat. No.	Pkg. Qty.
Center Jumpers⁽¹⁾		
2-pole	1492-CJP3-2	60
3-pole	1492-CJP3-3	20
4-pole	1492-CJP3-4	
5-pole	1492-CJP3-5	
6-pole	1492-CJP3-6	
7-pole	1492-CJP3-7	
8-pole	1492-CJP3-8	
9-pole	1492-CJP3-9	
10-pole	1492-CJP3-10	
20-pole	1492-CJP3-20	
50-pole	1492-CJP3-50	

Test Plugs			
Test Plugs	Start Test Plug	1492-PTPS	50
	Test Plug	1492-P3TPE	50

Marking Systems		
ClearPlot Basic Marker Cards	1492-MR5X8 (120/card)	5 cards
ClearMultiprint Markers	1492-MT5X8 (800/roll)	1 roll

(1) Available in orange as standard, to order other colors add the appropriate suffix to the catalog number listed: Blue =B, Red = RE. Example for a red 2-pole center jumper, the catalog number will be 1492-CJP3-2-RE.

Wiring Diagram

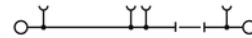

IMPORTANT See [page 69](#) for ferrule selection.

1492-PKD3T

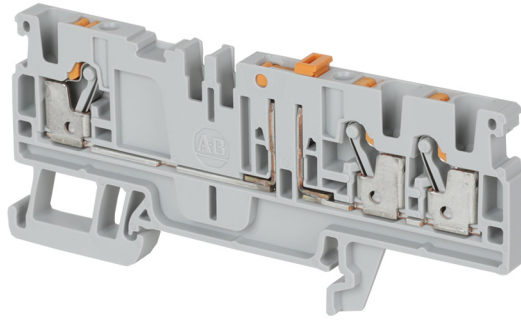

Terminal Blocks—Dimensions (W x H x L): 5.1 x 37.65 x 84.5 mm					
Color	Cat. No.	Pkg. Qty.	Color	Cat. No.	Pkg. Qty.
Grey	1492-PKD3T	50	Blue	1492-PKD3T-B	50

Specifications — Single-level Feed-through Terminal Block			
Certifications	/CSA	IEC	ATEX
Voltage Rating	300V AC/DC	500V AC/DC	400V AC/DC
Maximum Current	20 A	20 A	20 A
Wire Range (Rated Cross Section)	28...12 AWG	2.5 mm ²	2.5 mm ²
Wire Strip Length	0.4 in. (10 mm)		
Density	59 pcs/ft (196 pcs/m)		
Housing Temperature Range	-76...266°F (-60...130 °C)		

Accessories		Cat. No.	Pkg. Qty.
Mounting Rails, End Barriers, End Anchors and Retainers			
Mounting Rail 1 m Symmetrical DIN	Steel	199-DR1	10
	Aluminum	1492-DR5	10
	Hi-Rise (Aluminum)	1492-DR6	2
	Angled (Steel)	1492-DR7	2
End Barriers	Grey	1492-EBPKD3T	50
	Blue	1492-EBPKD3T-B	50
End Retainer		1492-ERL35	20
End Anchor DIN Rail	Normal Duty	1492-EAJ35	100
	Heavy Duty	1492-EAHJ35	50
	Normal Duty	1492-EAP35	50

Accessories		Cat. No.	Pkg. Qty.
Center Jumpers⁽¹⁾			
2-pole	Orange	1492-CJP3-2	20
3-pole		1492-CJP3-3	
4-pole		1492-CJP3-4	
5-pole		1492-CJP3-5	
6-pole		1492-CJP3-6	
7-pole		1492-CJP3-7	
8-pole		1492-CJP3-8	
9-pole		1492-CJP3-9	
10-pole		1492-CJP3-10	
20-pole		1492-CJP3-20	
50-pole		1492-CJP3-50	
Test Plugs			
Test Plugs	Start Test Plug	1492-PTPS	50
	Test Plug	1492-P3TPE	50
Marking Systems			
ClearPlot Basic Marker Cards	1492-MR5X8 (120/card)	5 cards	
ClearMultiprint Markers	1492-MT5X8 (800/roll)	1 roll	

(1) Available in orange as standard, to order other colors add the appropriate suffix to the catalog number listed: Blue =B, Red = RE. Example for a red 2-pole center jumper, the catalog number will be 1492-CJP3-2-RE.



Wiring Diagram

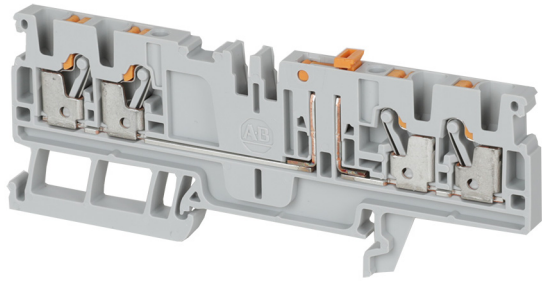

IMPORTANT See [page 69](#) for ferrule selection.

1492-PKD3Q



Terminal Blocks—Dimensions (W x H x L): 5.1 x 37.65 x 96 mm					
Color	Cat. No.	Pkg. Qty.	Color	Cat. No.	Pkg. Qty.
 Grey	1492-PKD3Q	50	 Blue	1492-PKD3Q-B	50

Specifications — Single-level Disconnect Terminal Block			
Certifications	 /CSA	IEC	ATEX
Voltage Rating	300V AC/DC	500V AC/DC	400V AC/DC
Maximum Current	20 A	20 A	20 A
Wire Range (Rated Cross Section)	28...12 AWG	2.5 mm ²	2.5 mm ²
Wire Strip Length	0.4 in. (10 mm)		
Density	59 pcs/ft (196 pcs/m)		
Housing Temperature Range	-76...266°F (-60...130 °C)		

Accessories	Cat. No.	Pkg. Qty.	
Mounting Rails, End Barriers, End Anchors and Retainers			
Mounting Rail 1 m Symmetrical DIN	Steel	199-DR1	10
	Aluminum	1492-DR5	10
	Hi-Rise (Aluminum)	1492-DR6	2
	Angled (Steel)	1492-DR7	2
End Barriers	Grey	1492-EBPKD3Q	50
	Blue	1492-EBPKD3Q-B	50
End Retainer	1492-ERL35	20	
End Anchor DIN Rail	Normal Duty	1492-EAJ35	100
	Heavy Duty	1492-EAHJ35	50
	Normal Duty	1492-EAP35	50

Accessories	Cat. No.	Pkg. Qty.
Center Jumpers⁽¹⁾		
2-pole	1492-CJP3-2	60
3-pole	1492-CJP3-3	20
4-pole	1492-CJP3-4	
5-pole	1492-CJP3-5	
6-pole	1492-CJP3-6	
7-pole	1492-CJP3-7	
8-pole	1492-CJP3-8	
9-pole	1492-CJP3-9	
10-pole	1492-CJP3-10	
20-pole	1492-CJP3-20	
50-pole	1492-CJP3-50	

Test Plugs			
Test Plugs	Start Test Plug	1492-PTPS	50
	Test Plug	1492-P3TPE	50

Marking Systems		
ClearPlot Basic Marker Cards	1492-MR5X8 (120/card)	5 cards
ClearMultiprint Markers	1492-MT5X8 (800/roll)	1 roll

(1) Available in orange as standard, to order other colors add the appropriate suffix to the catalog number listed: Blue =B, Red = RE. Example for a red 2-pole center jumper, the catalog number will be 1492-CJP3-2-RE.

Wiring Diagram

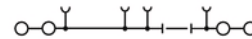

IMPORTANT See [page 69](#) for ferrule selection.

Sensor Terminal Blocks

1492-PS2-2

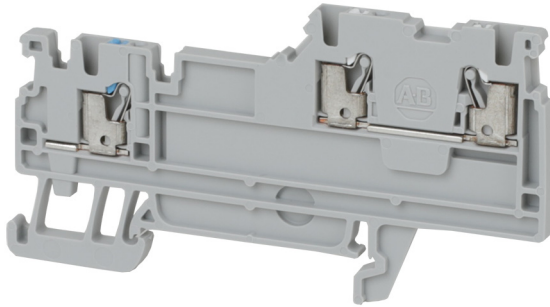

Terminal Blocks—Dimensions (W x H x L): 3.5 x 42 x 80 mm		
Color	Cat. No.	Pkg. Qty.
■ Grey	1492-PS2-2	100

Specifications — Sensor Terminal Block			
Certifications	UL/CSA	IEC	ATEX
Voltage Rating	150V AC/DC	250V AC/DC	220V AC/DC
Maximum Current	13 A	13.5 A	12 A
Wire Range (Rated Cross Section)	26...14 AWG	1.5 mm ²	1.5 mm ²
Wire Strip Length	0.31 in. (8 mm)		
Density	87 pcs/ft (285 pcs/m)		
Housing Temperature Range	-76...266°F (-60...130 °C)		

Accessories	Cat. No.	Pkg. Qty.	
Mounting Rails, End Barriers, End Anchors and Retainers			
Mounting Rail 1 m Symmetrical DIN	Steel	199-DR1	10
	Aluminum	1492-DR5	10
	Hi-Rise (Aluminum)	1492-DR6	2
	Angled (Steel)	1492-DR7	2
End Barriers	Grey	1492-EBPS-3	50
End Retainer		1492-ERL35	20
End Anchor DIN Rail	Normal Duty	1492-EAJ35	100
	Heavy Duty	1492-EAHJ35	50
	Normal Duty	1492-EAP35	50

Accessories	Cat. No.	Pkg. Qty.	
Center Jumpers⁽¹⁾			
2-pole	Blue	1492-CJP2-2-B	20
	Red	1492-CJP2-2-RE	20
3-pole	Blue	1492-CJP2-3-B	20
	Red	1492-CJP2-3-RE	20
4-pole	Blue	1492-CJP2-4-B	20
	Red	1492-CJP2-4-RE	20
5-pole	Blue	1492-CJP2-5-B	20
	Red	1492-CJP2-5-RE	20
6-pole	Blue	1492-CJP2-6-B	20
	Red	1492-CJP2-6-RE	20
7-pole	Blue	1492-CJP2-7-B	20
	Red	1492-CJP2-7-RE	20
8-pole	Blue	1492-CJP2-8-B	20
	Red	1492-CJP2-8-RE	20
9-pole	Blue	1492-CJP2-9-B	20
	Red	1492-CJP2-9-RE	20
10-pole	Blue	1492-CJP2-10-B	20
	Red	1492-CJP2-10-RE	20
20-pole	Blue	1492-CJP2-20-B	20
	Red	1492-CJP2-20-RE	20
50-pole	Blue	1492-CJP2-50-B	20
	Red	1492-CJP2-50-RE	20

Test Plugs			
Test Plugs	Start Test Plug	1492-PTPS	50
	Test Plug	1492-P2TPE	50

Marking Systems		
ClearPlot Basic Marker Cards	1492-M3X5 (100/card)	5 cards
ClearMultiprint Markers	1492-MT3X8 (1000/roll)	1 roll

(1) Available in orange, to order remove the -B or RE suffix from the catalog number. Example for an orange 2-pole center jumper, the catalog number will be 1492-CJP2-2.

Wiring Diagram



IMPORTANT See [page 68](#) for ferrule selection.

1492-PS2-3

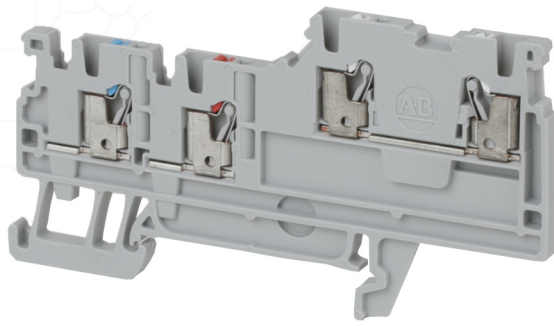

Terminal Blocks—Dimensions (W x H x L): 3.5 x 42 x 80 mm

Color	Cat. No.	Pkg. Qty.
■ Grey	1492-PS2-3	100

Specifications — Sensor Terminal Block

Certifications	UL / CSA	IEC	ATEX
Voltage Rating	150V AC/DC	250V AC/DC	220V AC/DC
Maximum Current	13 A	13.5 A	12 A
Wire Range (Rated Cross Section)	26...14 AWG	1.5 mm ²	1.5 mm ²
Wire Strip Length	0.31 in. (8 mm)		
Density	87 pcs/ft (285 pcs/m)		
Housing Temperature Range	-76...266°F (-60...130 °C)		

Accessories

Accessories	Cat. No.	Pkg. Qty.	
Mounting Rails, End Barriers, End Anchors and Retainers			
Mounting Rail 1 m Symmetrical DIN	Steel	199-DR1	10
	Aluminum	1492-DR5	10
	Hi-Rise (Aluminum)	1492-DR6	2
	Angled (Steel)	1492-DR7	2
End Barriers	Grey	1492-EBPS-3	50
End Retainer		1492-ERL35	20
End Anchor DIN Rail	Normal Duty	1492-EAJ35	100
	Heavy Duty	1492-EAHJ35	50
	Normal Duty	1492-EAP35	50

Accessories		Cat. No.	Pkg. Qty.
Center Jumpers⁽¹⁾			
2-pole	Blue	1492-CJP2-2-B	20
	Red	1492-CJP2-2-RE	20
3-pole	Blue	1492-CJP2-3-B	20
	Red	1492-CJP2-3-RE	20
4-pole	Blue	1492-CJP2-4-B	20
	Red	1492-CJP2-4-RE	20
5-pole	Blue	1492-CJP2-5-B	20
	Red	1492-CJP2-5-RE	20
6-pole	Blue	1492-CJP2-6-B	20
	Red	1492-CJP2-6-RE	20
7-pole	Blue	1492-CJP2-7-B	20
	Red	1492-CJP2-7-RE	20
8-pole	Blue	1492-CJP2-8-B	20
	Red	1492-CJP2-8-RE	20
9-pole	Blue	1492-CJP2-9-B	20
	Red	1492-CJP2-9-RE	20
10-pole	Blue	1492-CJP2-10-B	20
	Red	1492-CJP2-10-RE	20
20-pole	Blue	1492-CJP2-20-B	20
	Red	1492-CJP2-20-RE	20
50-pole	Blue	1492-CJP2-50-B	20
	Red	1492-CJP2-50-RE	20

Test Plugs			
Test Plugs	Start Test Plug	1492-PTPS	50
	Test Plug	1492-P2TPE	50

Marking Systems		
ClearPlot Basic Marker Cards	1492-M3X5 (100/card)	5 cards
ClearMultiprint Markers	1492-MT3X8 (1000/roll)	1 roll

(1) Available in orange, to order remove the -B or RE suffix from the catalog number. Example for an orange 2-pole center jumper, the catalog number will be 1492-CJP2-2.

Wiring Diagram

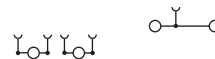

IMPORTANT See [page 68](#) for ferrule selection.

1492-PSG2-3

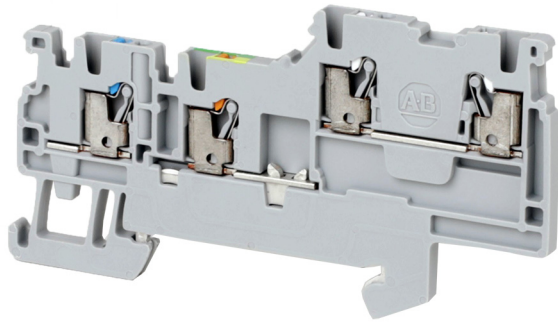

Terminal Blocks—Dimensions (W x H x L): 3.5 x 42 x 80 mm

Color	Cat. No.	Pkg. Qty.
■ Grey	1492-PSG2-3	100

Specifications — Sensor with Grounding Terminal Block

Certifications	UL / CSA	IEC	ATEX
Voltage Rating	150V AC/DC	250V AC/DC	220V AC/DC
Maximum Current	13 A	13.5 A	12 A
Wire Range (Rated Cross Section)	26...14 AWG	1.5 mm ²	1.5 mm ²
Wire Strip Length	0.31 in. (8 mm)		
Density	87 pcs/ft (285 pcs/m)		
Housing Temperature Range	-76...266°F (-60...130 °C)		

Accessories

Accessories	Cat. No.	Pkg. Qty.	
Mounting Rails, End Barriers, End Anchors and Retainers			
Mounting Rail 1 m Symmetrical DIN	Steel	199-DR1	10
	Aluminum	1492-DR5	10
	Hi-Rise (Aluminum)	1492-DR6	2
	Angled (Steel)	1492-DR7	2
End Barriers	Grey	1492-EBPS-3	50
End Retainer		1492-ERL35	20
End Anchor DIN Rail	Normal Duty	1492-EAJ35	100
	Heavy Duty	1492-EAHJ35	50
	Normal Duty	1492-EAP35	50

Accessories

Accessories	Cat. No.	Pkg. Qty.	
Center Jumpers⁽¹⁾			
2-pole	Blue	1492-CJP2-2-B	20
	Red	1492-CJP2-2-RE	20
3-pole	Blue	1492-CJP2-3-B	20
	Red	1492-CJP2-3-RE	20
4-pole	Blue	1492-CJP2-4-B	20
	Red	1492-CJP2-4-RE	20
5-pole	Blue	1492-CJP2-5-B	20
	Red	1492-CJP2-5-RE	20
6-pole	Blue	1492-CJP2-6-B	20
	Red	1492-CJP2-6-RE	20
7-pole	Blue	1492-CJP2-7-B	20
	Red	1492-CJP2-7-RE	20
8-pole	Blue	1492-CJP2-8-B	20
	Red	1492-CJP2-8-RE	20
9-pole	Blue	1492-CJP2-9-B	20
	Red	1492-CJP2-9-RE	20
10-pole	Blue	1492-CJP2-10-B	20
	Red	1492-CJP2-10-RE	20
20-pole	Blue	1492-CJP2-20-B	20
	Red	1492-CJP2-20-RE	20
50-pole	Blue	1492-CJP2-50-B	20
	Red	1492-CJP2-50-RE	20

Test Plugs

Test Plugs	Start Test Plug	1492-PTPS	50
	Test Plug	1492-P2TPE	50

Marking Systems

ClearPlot Basic Marker Cards	1492-M3X5 (100/card)	5 cards
ClearMultiprint Markers	1492-MT3X8 (1000/roll)	1 roll

(1) Available in orange, to order remove the -B or RE suffix from the catalog number. Example for an orange 2-pole center jumper, the catalog number will be 1492-CJP2-2.

Wiring Diagram

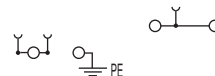

IMPORTANT See [page 68](#) for ferrule selection.

1492-PS2-4

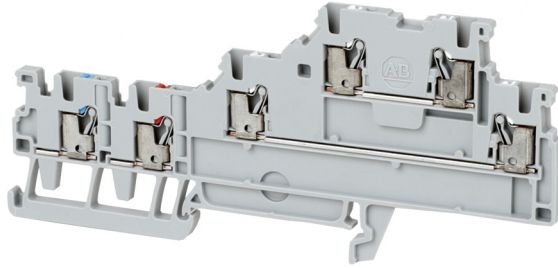

Terminal Blocks—Dimensions (W x H x L): 3.5 x 49.5 x 110 mm		
Color	Cat. No.	Pkg. Qty.
 Grey	1492-PS2-4	100

Specifications — Sensor Terminal Block			
Certifications	 /CSA	IEC	ATEX
Voltage Rating	150V AC/DC	250V AC/DC	220V AC/DC
Maximum Current	13 A	13.5 A	12 A
Wire Range (Rated Cross Section)	26...14 AWG	1.5 mm ²	1.5 mm ²
Wire Strip Length	0.31 in. (8 mm)		
Density	87 pcs/ft (285 pcs/m)		
Housing Temperature Range	-76...266°F (-60...130 °C)		

Accessories		Cat. No.	Pkg. Qty.
Mounting Rails, End Barriers, End Anchors and Retainers			
Mounting Rail 1 m Symmetrical DIN	Steel	199-DR1	10
	Aluminum	1492-DR5	10
	Hi-Rise (Aluminum)	1492-DR6	2
	Angled (Steel)	1492-DR7	2
End Barriers	Grey	1492-EBPS-4	50
End Retainer		1492-ERL35	20
End Anchor DIN Rail	Normal Duty	1492-EAJ35	100
	Heavy Duty	1492-EAHJ35	50
	Normal Duty	1492-EAP35	50

Accessories		Cat. No.	Pkg. Qty.
Center Jumpers⁽¹⁾			
2-pole	Blue	1492-CJP2-2-B	20
	Red	1492-CJP2-2-RE	20
3-pole	Blue	1492-CJP2-3-B	20
	Red	1492-CJP2-3-RE	20
4-pole	Blue	1492-CJP2-4-B	20
	Red	1492-CJP2-4-RE	20
5-pole	Blue	1492-CJP2-5-B	20
	Red	1492-CJP2-5-RE	20
6-pole	Blue	1492-CJP2-6-B	20
	Red	1492-CJP2-6-RE	20
7-pole	Blue	1492-CJP2-7-B	20
	Red	1492-CJP2-7-RE	20
8-pole	Blue	1492-CJP2-8-B	20
	Red	1492-CJP2-8-RE	20
9-pole	Blue	1492-CJP2-9-B	20
	Red	1492-CJP2-9-RE	20
10-pole	Blue	1492-CJP2-10-B	20
	Red	1492-CJP2-10-RE	20
20-pole	Blue	1492-CJP2-20-B	20
	Red	1492-CJP2-20-RE	20
50-pole	Blue	1492-CJP2-50-B	20
	Red	1492-CJP2-50-RE	20

Test Plugs			
Test Plugs	Start Test Plug	1492-PTPS	50
	Test Plug	1492-P2TPE	50

Marking Systems		
ClearPlot Basic Marker Cards	1492-M3X5 (100/card)	5 cards
ClearMultiprint Markers	1492-MT3X8 (1000/roll)	1 roll

(1) Available in orange. To order, remove the -B or RE suffix from the catalog number. Example for an orange 2-pole center jumper, the catalog number will be 1492-CJP2-2.

Wiring Diagram

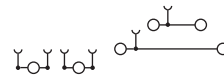

IMPORTANT See [page 68](#) for ferrule selection.

1492-PSG2-4

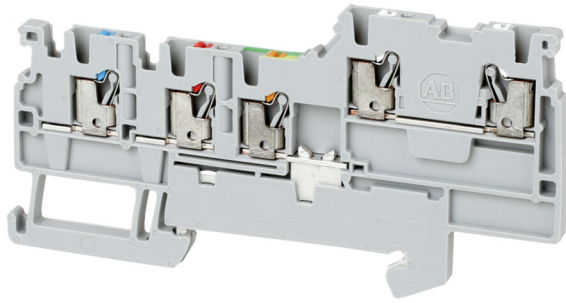

Terminal Blocks—Dimensions (W x H x L): 3.5 x 45x 89 mm		
Color	Cat. No.	Pkg. Qty.
 Grey	1492-PSG2-4	100

Specifications — Sensor with Grounding Terminal Block			
Certifications	UL /CSA	IEC	ATEX
Voltage Rating	150V AC/DC	250V AC/DC	220V AC/DC
Maximum Current	13 A	13.5 A	12 A
Wire Range (Rated Cross Section)	26...14 AWG	1.5 mm ²	1.5 mm ²
Wire Strip Length	0.31 in. (8 mm)		
Density	87 pcs/ft (285 pcs/m)		
Housing Temperature Range	-76...266°F (-60...130 °C)		

Accessories		Cat. No.	Pkg. Qty.
Mounting Rails, End Barriers, End Anchors and Retainers			
Mounting Rail 1 m Symmetrical DIN	Steel	199-DR1	10
	Aluminum	1492-DR5	10
	Hi-Rise (Aluminum)	1492-DR6	2
	Angled (Steel)	1492-DR7	2
End Barriers	Grey	1492-EBPGS-4	50
End Retainer		1492-ERL35	20
End Anchor DIN Rail	Normal Duty	1492-EAJ35	100
	Heavy Duty	1492-EAHJ35	50
	Normal Duty	1492-EAP35	50

Accessories		Cat. No.	Pkg. Qty.
Center Jumpers⁽¹⁾			
2-pole	Blue	1492-CJP2-2-B	20
	Red	1492-CJP2-2-RE	20
3-pole	Blue	1492-CJP2-3-B	20
	Red	1492-CJP2-3-RE	20
4-pole	Blue	1492-CJP2-4-B	20
	Red	1492-CJP2-4-RE	20
5-pole	Blue	1492-CJP2-5-B	20
	Red	1492-CJP2-5-RE	20
6-pole	Blue	1492-CJP2-6-B	20
	Red	1492-CJP2-6-RE	20
7-pole	Blue	1492-CJP2-7-B	20
	Red	1492-CJP2-7-RE	20
8-pole	Blue	1492-CJP2-8-B	20
	Red	1492-CJP2-8-RE	20
9-pole	Blue	1492-CJP2-9-B	20
	Red	1492-CJP2-9-RE	20
10-pole	Blue	1492-CJP2-10-B	20
	Red	1492-CJP2-10-RE	20
20-pole	Blue	1492-CJP2-20-B	20
	Red	1492-CJP2-20-RE	20
50-pole	Blue	1492-CJP2-50-B	20
	Red	1492-CJP2-50-RE	20

Test Plugs			
Test Plugs	Start Test Plug	1492-PTPS	50
	Test Plug	1492-P2TPE	50

Marking Systems		
ClearPlot Basic Marker Cards	1492-M3X5 (100/card)	5 cards
ClearMultiprint Markers	1492-MT3X8 (1000/roll)	1 roll

(1) Available in orange, to order remove the -B or RE suffix from the catalog number. Example for an orange 2-pole center jumper, the catalog number will be 1492-CJP2-2.

Wiring Diagram

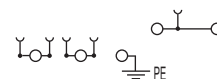



IMPORTANT See [page 68](#) for ferrule selection.

Control Power Distribution Terminal Blocks

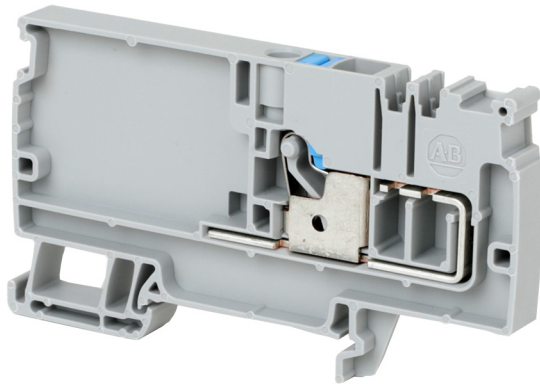
1492-P6PD2S-1B



Terminal Blocks—Dimensions (W x H x L): 8.1 x 48 x 85.5 mm		
Color	Cat. No.	Pkg. Qty.
 Grey	1492-P6PD2S-1B	20

Specifications — Control Power Distribution Terminal Block			
Certifications	 /CSA	IEC	ATEX
Voltage Rating	300V AC/DC	500V AC/DC	550V AC/DC
Maximum Current	36 A	41 A	33 A
Wire Range (Rated Cross Section)	22...8 AWG	6 mm ²	6 mm ²
Wire Strip Length	0.47 in. (12 mm)		
Density	37 pcs/ft (123 pcs/m)		
Housing Temperature Range	-76...266°F (-60...130 °C)		

Accessories	Cat. No.	Pkg. Qty.	
Mounting Rails, End Barriers, End Anchors and Retainers			
Mounting Rail 1 m Symmetrical DIN	Steel	199-DR1	10
	Aluminum	1492-DR5	10
	Hi-Rise (Aluminum)	1492-DR6	2
	Angled (Steel)	1492-DR7	2
End Barriers	Grey	1492-EBP6PD2	20
End Retainer		1492-ERL35	20
End Anchor DIN Rail	Normal Duty	1492-EAJ35	100
	Heavy Duty	1492-EAHJ35	50
	Normal Duty	1492-EAP35	50

Accessories	Cat. No.	Pkg. Qty.
Center Jumpers⁽¹⁾		
2-pole	1492-CJP2-2-B	20
3-pole	1492-CJP2-3-B	
4-pole	1492-CJP2-4-B	
5-pole	1492-CJP2-5-B	
6-pole	1492-CJP2-6-B	
7-pole	1492-CJP2-7-B	
8-pole	1492-CJP2-8-B	
9-pole	1492-CJP2-9-B	
10-pole	1492-CJP2-10-B	
20-pole	1492-CJP2-20-B	
50-pole	1492-CJP2-50-B	

Test Plugs			
Test Plugs	Start Test Plug	1492-PTPS	50
	Test Plug	1492-P6TPE	50

Marking Systems		
ClearPlot Basic Marker Cards	1492-MR6X8 (120/card)	5 cards
ClearMultiprint Markers	1492-MT8X8 (500/roll)	1 roll

(1) Available in orange, to order remove the -B suffix from the catalog number. Example for an orange 2-pole center jumper, the catalog number will be 1492-CJP2-2.

Wiring Diagram

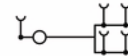

IMPORTANT See [page 71](#) for ferrule selection.

1492-P6PD2S-1RE

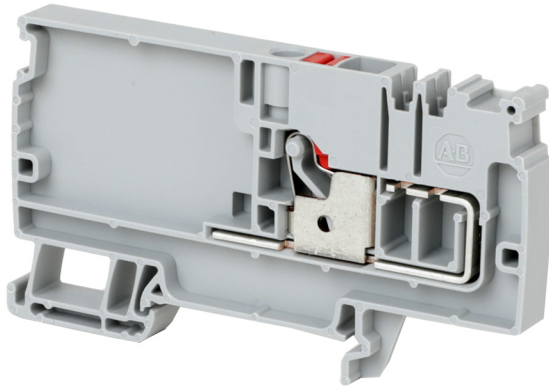

Terminal Blocks—Dimensions (W x H x L): 8.1 x 48 x 85.5 mm			
Color	Cat. No.	Pkg. Qty.	
Grey	1492-P6PD2S-1RE	20	

Specifications — Control Power Distribution Terminal Block			
Certifications	/CSA	IEC	ATEX
Voltage Rating	300V AC/DC	500V AC/DC	550V AC/DC
Maximum Current	36 A	41 A	33 A
Wire Range (Rated Cross Section)	22...8 AWG	6 mm ²	6 mm ²
Wire Strip Length	0.47 in. (12 mm)		
Density	37 pcs/ft (123 pcs/m)		
Housing Temperature Range	-76...266°F (-60...130 °C)		

Accessories	Cat. No.	Pkg. Qty.	
Mounting Rails, End Barriers, End Anchors and Retainers			
Mounting Rail 1 m Symmetrical DIN	Steel	199-DR1	10
	Aluminum	1492-DR5	10
	Hi-Rise (Aluminum)	1492-DR6	2
	Angled (Steel)	1492-DR7	2
End Barriers	Grey	1492-EBP6PD2	20
End Retainer		1492-ERL35	20
End Anchor DIN Rail	Normal Duty	1492-EAJ35	100
	Heavy Duty	1492-EAHJ35	50
	Normal Duty	1492-EAP35	50

Accessories	Cat. No.	Pkg. Qty.
Center Jumpers⁽¹⁾		
2-pole	1492-CJP2-2-RE	20
3-pole	1492-CJP2-3-RE	
4-pole	1492-CJP2-4-RE	
5-pole	1492-CJP2-5-RE	
6-pole	1492-CJP2-6-RE	
7-pole	1492-CJP2-7-RE	
8-pole	1492-CJP2-8-RE	
9-pole	1492-CJP2-9-RE	
10-pole	1492-CJP2-10-RE	
20-pole	1492-CJP2-20-RE	
50-pole	1492-CJP2-50-RE	

Test Plugs			
Test Plugs	Start Test Plug	1492-PTPS	50
	Test Plug	1492-P6TPE	50

Marking Systems		
ClearPlot Basic Marker Cards	1492-MR6X8 (120/card)	5 cards
ClearMultiprint Markers	1492-MT8X8 (500/roll)	1 roll

(1) Available in orange, to order remove the -RE suffix from the catalog number. Example for an orange 2-pole center jumper, the catalog number will be 1492-CJP2-2.

Wiring Diagram

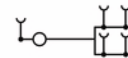

IMPORTANT See [page 71](#) for ferrule selection.

1492-PG6PD2S

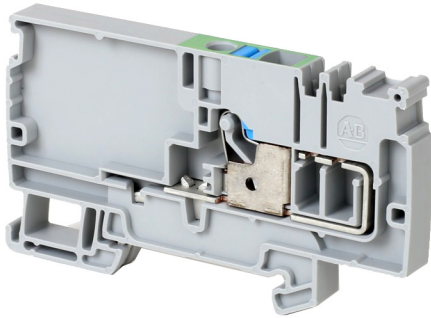

Terminal Blocks—Dimensions (W x H x L): 8.1 x 48 x 85.5 mm		
Color	Cat. No.	Pkg. Qty.
 Grey	1492-PG6PD2S	20

Specifications — Control Power Distribution with Grounding Terminal Block			
Certifications	 /CSA	IEC	ATEX
Voltage Rating	300V AC/DC	500V AC/DC	550V AC/DC
Wire Range (Rated Cross Section)	22...8 AWG	6 mm ²	6 mm ²
Wire Strip Length	0.47 in. (12 mm)		
Density	37 pcs/ft (123 pcs/m)		
Housing Temperature Range	-76...266°F (-60...130 °C)		

Accessories	Cat. No.	Pkg. Qty.	
Mounting Rails, End Barriers, End Anchors and Retainers			
Mounting Rail 1 m Symmetrical DIN	Steel	199-DR1	10
	Aluminum	1492-DR5	10
	Hi-Rise (Aluminum)	1492-DR6	2
	Angled (Steel)	1492-DR7	2
End Barriers	Grey	1492-EBP6PD2	20
End Retainer		1492-ERL35	20
End Anchor DIN Rail	Normal Duty	1492-EAJ35	100
	Heavy Duty	1492-EAHJ35	50
	Normal Duty	1492-EAP35	50

Accessories	Cat. No.	Pkg. Qty.
Center Jumpers⁽¹⁾		
2-pole	1492-CJP2-2-B	20
3-pole	1492-CJP2-3-B	
4-pole	1492-CJP2-4-B	
5-pole	1492-CJP2-5-B	
6-pole	1492-CJP2-6-B	
7-pole	1492-CJP2-7-B	
8-pole	1492-CJP2-8-B	
9-pole	1492-CJP2-9-B	
10-pole	1492-CJP2-10-B	
20-pole	1492-CJP2-20-B	
50-pole	1492-CJP2-50-B	

Test Plugs			
Test Plugs	Start Test Plug	1492-PTPS	50
	Test Plug	1492-P6TPE	50

Marking Systems		
ClearPlot Basic Marker Cards	1492-MR6X8 (120/card)	5 cards
ClearMultiprint Markers	1492-MT8X8 (500/roll)	1 roll

(1) Available in orange, to order remove the -B suffix from the catalog number. Example for an orange 2-pole center jumper, the catalog number will be 1492-CJP2-2.

Wiring Diagram

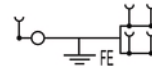

IMPORTANT See [page 71](#) for ferrule selection.

1492-P6PD2E-6B

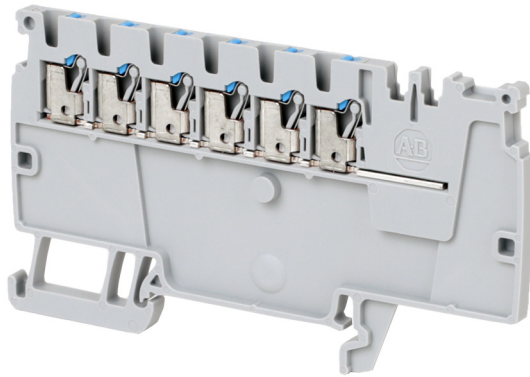

Terminal Blocks—Dimensions (W x H x L): 3.5x 48 x 85.5 mm

Color	Cat. No.	Pkg. Qty.
 Grey	1492-P6PD2E-6B	50

Specifications — Control Power Distribution Terminal Block

Certifications	UL /CSA	IEC	ATEX
Voltage Rating	300V AC/DC	500V AC/DC	550V AC/DC
Maximum Current	13 A	17.5 A	13 A
Wire Range (Rated Cross Section)	26...14 AWG	1.5 mm ²	1.5 mm ²
Wire Strip Length	0.31 in. (8 mm)		
Density	87 pcs/ft (285 pcs/m)		
Housing Temperature Range	-76...266°F (-60...130 °C)		

Accessories	Cat. No.	Pkg. Qty.
-------------	----------	-----------

Mounting Rails, End Barriers, End Anchors and Retainers

Mounting Rail 1 m Symmetrical DIN	Steel	199-DR1	10
	Aluminum	1492-DR5	10
	Hi-Rise (Aluminum)	1492-DR6	2
	Angled (Steel)	1492-DR7	2
End Barriers	Grey	1492-EBP6PD2	20
End Retainer		1492-ERL35	20
End Anchor DIN Rail	Normal Duty	1492-EAJ35	100
	Heavy Duty	1492-EAHJ35	50
	Normal Duty	1492-EAP35	50

Accessories	Cat. No.	Pkg. Qty.
Center Jumpers⁽¹⁾		
2-pole	1492-CJP2-2-B	20
3-pole	1492-CJP2-3-B	
4-pole	1492-CJP2-4-B	
5-pole	1492-CJP2-5-B	
6-pole	1492-CJP2-6-B	
7-pole	1492-CJP2-7-B	
8-pole	1492-CJP2-8-B	
9-pole	1492-CJP2-9-B	
10-pole	1492-CJP2-10-B	
20-pole	1492-CJP2-20-B	
50-pole	1492-CJP2-50-B	

Marking Systems

ClearPlot Basic Marker Cards	1492-M3X5 (100/card)	5 cards
ClearMultiprint Markers	1492-MT3X8 (1000/roll)	1 roll

(1) Available in orange, to order remove the -B suffix from the catalog number. Example for an orange 2-pole center jumper, the catalog number will be 1492-CJP2-2.

Wiring Diagram

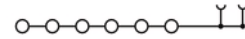

IMPORTANT See [page 68](#) for ferrule selection.

1492-P6PD2E-6RE

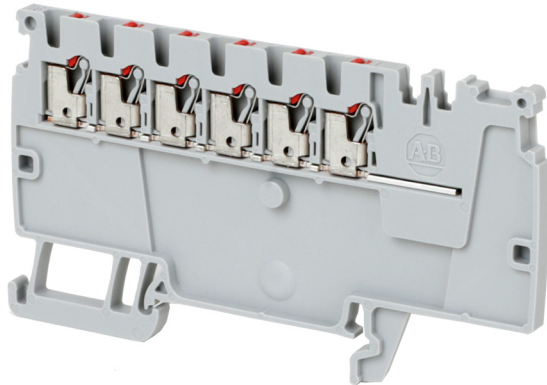

Terminal Blocks—Dimensions (W x H x L): 3.5x 48 x 85.5 mm			
Color		Cat. No.	Pkg. Qty.
	Grey	1492-P6PD2E-6RE	50

Specifications — Control Power Distribution Terminal Block			
Certifications	UL /CSA	IEC	ATEX
Voltage Rating	300V AC/DC	500V AC/DC	550V AC/DC
Maximum Current	13 A	17.5 A	13 A
Wire Range (Rated Cross Section)	26...14 AWG	1.5 mm ²	1.5 mm ²
Wire Strip Length	0.31 in. (8 mm)		
Density	87 pcs/ft (285 pcs/m)		
Housing Temperature Range	-76...266°F (-60...130 °C)		

Accessories		Cat. No.	Pkg. Qty.
Mounting Rails, End Barriers, End Anchors and Retainers			
Mounting Rail 1 m Symmetrical DIN	Steel	199-DR1	10
	Aluminum	1492-DR5	10
	Hi-Rise (Aluminum)	1492-DR6	2
	Angled (Steel)	1492-DR7	2
End Barriers	Grey	1492-EBP6PD2	20
End Retainer		1492-ERL35	20
End Anchor DIN Rail	Normal Duty	1492-EAJ35	100
	Heavy Duty	1492-EAHJ35	50
	Normal Duty	1492-EAP35	50

Accessories		Cat. No.	Pkg. Qty.
Center Jumpers⁽¹⁾			
2-pole	Red	1492-CJP2-2-RE	20
3-pole		1492-CJP2-3-RE	
4-pole		1492-CJP2-4-RE	
5-pole		1492-CJP2-5-RE	
6-pole		1492-CJP2-6-RE	
7-pole		1492-CJP2-7-RE	
8-pole		1492-CJP2-8-RE	
9-pole		1492-CJP2-9-RE	
10-pole		1492-CJP2-10-RE	
20-pole		1492-CJP2-20-RE	
50-pole		1492-CJP2-50-RE	

Marking Systems		
ClearPlot Basic Marker Cards	1492-M3X5 (100/card)	5 cards
ClearMultiprint Markers	1492-MT3X8 (1000/roll)	1 roll

(1) Available in orange, to order remove the -RE suffix from the catalog number. Example for an orange 2-pole center jumper, the catalog number will be 1492-CJP2-2.

Wiring Diagram

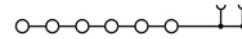

IMPORTANT See [page 68](#) for ferrule selection.

1492-P6PD2S-1B1RE

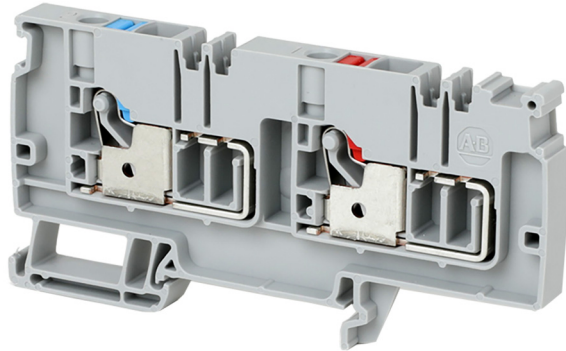

Terminal Blocks—Dimensions (W x H x L): 8.1 x 48 x 96 mm

Color	Cat. No.	Pkg. Qty.
■ Grey	1492-P6PD2S-1B1RE	20

Specifications — Control Power Distribution Terminal Block

Certifications	UL /CSA	IEC	ATEX
Voltage Rating	150V AC/DC	250V AC/DC	220V AC/DC
Maximum Current	36 A	41 A	33 A
Wire Range (Rated Cross Section)	22...8 AWG	6 mm ²	6 mm ²
Wire Strip Length	0.47 in. (12 mm)		
Density	37 pcs/ft (123 pcs/m)		
Housing Temperature Range	-76...266°F (-60...130 °C)		

Accessories	Cat. No.	Pkg. Qty.
-------------	----------	-----------

Mounting Rails, End Barriers, End Anchors and Retainers

Mounting Rail 1 m Symmetrical DIN	Steel	199-DR1	10
	Aluminum	1492-DR5	10
	Hi-Rise (Aluminum)	1492-DR6	2
	Angled (Steel)	1492-DR7	2
End Barriers	Grey	1492-EBP6PD2-BRE	20
End Retainer		1492-ERL35	20
End Anchor DIN Rail	Normal Duty	1492-EAJ35	100
	Heavy Duty	1492-EAHJ35	50
	Heavy Duty	1492-EAP35	50

Accessories		Cat. No.	Pkg. Qty.
Center Jumpers⁽¹⁾			
2-pole	Blue	1492-CJP2-2-B	20
	Red	1492-CJP2-2-RE	20
3-pole	Blue	1492-CJP2-3-B	20
	Red	1492-CJP2-3-RE	20
4-pole	Blue	1492-CJP2-4-B	20
	Red	1492-CJP2-4-RE	20
5-pole	Blue	1492-CJP2-5-B	20
	Red	1492-CJP2-5-RE	20
6-pole	Blue	1492-CJP2-6-B	20
	Red	1492-CJP2-6-RE	20
7-pole	Blue	1492-CJP2-7-B	20
	Red	1492-CJP2-7-RE	20
8-pole	Blue	1492-CJP2-8-B	20
	Red	1492-CJP2-8-RE	20
9-pole	Blue	1492-CJP2-9-B	20
	Red	1492-CJP2-9-RE	20
10-pole	Blue	1492-CJP2-10-B	20
	Red	1492-CJP2-10-RE	20
20-pole	Blue	1492-CJP2-20-B	20
	Red	1492-CJP2-20-RE	20
50-pole	Blue	1492-CJP2-50-B	20
	Red	1492-CJP2-50-RE	20

Test Plugs			
Test Plugs	Start Test Plug	1492-PTPS	50
	Test Plug	1492-P6TPE	50

Marking Systems			
ClearPlot Basic Marker Cards	1492-MR6X8 (120/card)	5 cards	
ClearMultiprint Markers	1492-MT8X8 (600/roll)	1 roll	

(1) Available in orange, to order remove the -B or RE suffix from the catalog number. Example for an orange 2-pole center jumper, the catalog number will be 1492-CJP2-2.

Wiring Diagram

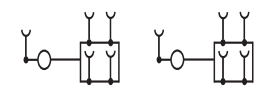

IMPORTANT See [page 71](#) for ferrule selection.

1492-P6PD2S-1RE1G

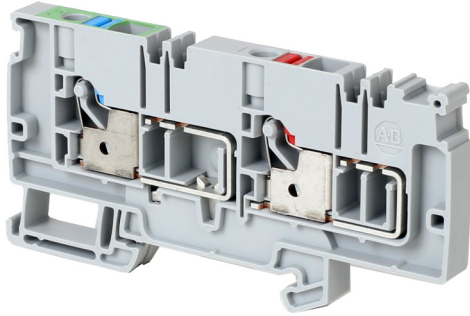

Terminal Blocks—Dimensions (W x H x L): 8.1 x 48 x 96 mm		
Color	Cat. No.	Pkg. Qty.
■ Grey	1492-P6PD2S-1RE1G	20

Specifications — Control Power Distribution with Grounding Terminal Block			
Certifications	UL /CSA	IEC	ATEX
Voltage Rating	150V AC/DC	250V AC/DC	220V AC/DC
Maximum Current	36 A	41 A	33 A
Wire Range (Rated Cross Section)	22...8 AWG	6 mm ²	6 mm ²
Wire Strip Length	0.47 in. (12 mm)		
Density	37 pcs/ft (123 pcs/m)		
Housing Temperature Range	-76...266°F (-60...130 °C)		

Accessories	Cat. No.	Pkg. Qty.	
Mounting Rails, End Barriers, End Anchors and Retainers			
Mounting Rail 1 m Symmetrical DIN	Steel	199-DR1	10
	Aluminum	1492-DR5	10
	Hi-Rise (Aluminum)	1492-DR6	2
	Angled (Steel)	1492-DR7	2
End Barriers	Grey	1492-EBP6PD2-BRE	20
End Retainer		1492-ERL35	20
End Anchor DIN Rail	Normal Duty	1492-EAJ35	100
	Heavy Duty	1492-EAHJ35	50
	Normal Duty	1492-EAP35	50

Accessories		Cat. No.	Pkg. Qty.
Center Jumpers⁽¹⁾			
2-pole	Blue	1492-CJP2-2-B	20
	Red	1492-CJP2-2-RE	20
3-pole	Blue	1492-CJP2-3-B	20
	Red	1492-CJP2-3-RE	20
4-pole	Blue	1492-CJP2-4-B	20
	Red	1492-CJP2-4-RE	20
5-pole	Blue	1492-CJP2-5-B	20
	Red	1492-CJP2-5-RE	20
6-pole	Blue	1492-CJP2-6-B	20
	Red	1492-CJP2-6-RE	20
7-pole	Blue	1492-CJP2-7-B	20
	Red	1492-CJP2-7-RE	20
8-pole	Blue	1492-CJP2-8-B	20
	Red	1492-CJP2-8-RE	20
9-pole	Blue	1492-CJP2-9-B	20
	Red	1492-CJP2-9-RE	20
10-pole	Blue	1492-CJP2-10-B	20
	Red	1492-CJP2-10-RE	20
20-pole	Blue	1492-CJP2-20-B	20
	Red	1492-CJP2-20-RE	20
50-pole	Blue	1492-CJP2-50-B	20
	Red	1492-CJP2-50-RE	20

Test Plugs			
Test Plugs	Start Test Plug	1492-PTPS	50
	Test Plug	1492-P6TPE	50

Marking Systems		
ClearPlot Basic Marker Cards	1492-MR6X8 (120/card)	5 cards
ClearMultiprint Markers	1492-MT8X8 (600/roll)	1 roll

(1) Available in orange, to order remove the -B or RE suffix from the catalog number. Example for an orange 2-pole center jumper, the catalog number will be 1492-CJP2-2.

Wiring Diagram

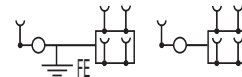

IMPORTANT See [page 71](#) for ferrule selection.

1492-P6PD2E-3B3RE

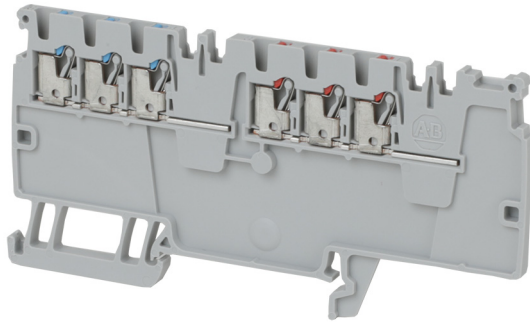

Terminal Blocks—Dimensions (W x H x L): 3.5x 48 x 96 mm			
Color	Cat. No.	Pkg. Qty.	
■ Grey	1492-P6PD2E-3B3RE	50	

Specifications — Control Power Distribution Terminal Block			
Certifications	UL /CSA	IEC	ATEX
Voltage Rating	150V AC/DC	250V AC/DC	220V AC/DC
Maximum Current	13 A	16 A	13 A
Wire Range (Rated Cross Section)	26...14 AWG	1.5 mm ²	1.5 mm ²
Wire Strip Length	0.31 in. (12 mm)		
Density	87 pcs/ft (285 pcs/m)		
Housing Temperature Range	-76...266°F (-60...130 °C)		

Accessories	Cat. No.	Pkg. Qty.	
Mounting Rails, End Barriers, End Anchors and Retainers			
Mounting Rail 1 m Symmetrical DIN	Steel	199-DR1	10
	Aluminum	1492-DR5	10
	Hi-Rise (Aluminum)	1492-DR6	2
	Angled (Steel)	1492-DR7	2
End Barriers	Grey	1492-EBP6PD2-BRE	20
End Retainer		1492-ERL35	20
End Anchor DIN Rail	Normal Duty	1492-EAJ35	100
	Heavy Duty	1492-EAHJ35	50
	Normal Duty	1492-EAP35	50

Accessories	Cat. No.	Pkg. Qty.	
Center Jumpers⁽¹⁾			
2-pole	Blue	1492-CJP2-2-B	20
	Red	1492-CJP2-2-RE	20
3-pole	Blue	1492-CJP2-3-B	20
	Red	1492-CJP2-3-RE	20
4-pole	Blue	1492-CJP2-4-B	20
	Red	1492-CJP2-4-RE	20
5-pole	Blue	1492-CJP2-5-B	20
	Red	1492-CJP2-5-RE	20
6-pole	Blue	1492-CJP2-6-B	20
	Red	1492-CJP2-6-RE	20
7-pole	Blue	1492-CJP2-7-B	20
	Red	1492-CJP2-7-RE	20
8-pole	Blue	1492-CJP2-8-B	20
	Red	1492-CJP2-8-RE	20
9-pole	Blue	1492-CJP2-9-B	20
	Red	1492-CJP2-9-RE	20
10-pole	Blue	1492-CJP2-10-B	20
	Red	1492-CJP2-10-RE	20
20-pole	Blue	1492-CJP2-20-B	20
	Red	1492-CJP2-20-RE	20
50-pole	Blue	1492-CJP2-50-B	20
	Red	1492-CJP2-50-RE	20

Marking Systems		
ClearPlot Basic Marker Cards	1492-M3X5 (100/card)	5 cards
ClearMultiprint Markers	1492-MT3X8 (1000/roll)	1 roll

(1) Available in orange, to order remove the -B or RE suffix from the catalog number. Example for an orange 2-pole center jumper, the catalog number will be 1492-CJP2-2.

Wiring Diagram

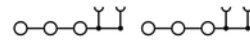

IMPORTANT See [page 68](#) for ferrule selection.

1492-P10PD3S-1B

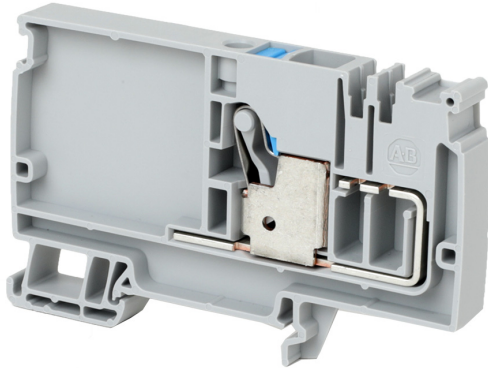

Terminal Blocks—Dimensions (W x H x L): 10 x 54 x 89 mm		
Color	Cat. No.	Pkg. Qty.
■ Grey	1492-P10PD3S-1B	20

Specifications — Control Power Distribution Terminal Block			
Certifications	UL /CSA	IEC	ATEX
Voltage Rating	600V AC/DC	800V AC/DC	690V AC/DC
Maximum Current	51 A	57 A	45 A
Wire Range (Rated Cross Section)	20...6 AWG	10 mm ²	10 mm ²
Wire Strip Length	0.71 (18 mm)		
Density	30 pcs/ft (100 pcs/m)		
Housing Temperature Range	-76...266°F (-60...130 °C)		

Accessories		Cat. No.	Pkg. Qty.
Mounting Rails, End Barriers, End Anchors and Retainers			
Mounting Rail 1 m Symmetrical DIN	Steel	199-DR1	10
	Aluminum	1492-DR5	10
	Hi-Rise (Aluminum)	1492-DR6	2
	Angled (Steel)	1492-DR7	2
End Barriers	Grey	1492-EBP10PD3	20
End Retainer		1492-ERL35	20
End Anchor DIN Rail	Normal Duty	1492-EAJ35	100
	Heavy Duty	1492-EAHJ35	50
	Normal Duty	1492-EAP35	50

Accessories		Cat. No.	Pkg. Qty.
Center Jumpers⁽¹⁾			
2-pole	Blue	1492-CJP3-2-B	60
3-pole		1492-CJP3-3-B	20
4-pole		1492-CJP3-4-B	
5-pole		1492-CJP3-5-B	
6-pole		1492-CJP3-6-B	
7-pole		1492-CJP3-7-B	
8-pole		1492-CJP3-8-B	
9-pole		1492-CJP3-9-B	
10-pole		1492-CJP3-10-B	
20-pole		1492-CJP3-20-B	
50-pole		1492-CJP3-50-B	

Test Plugs			
Test Plugs	Start Test Plug	1492-PTPS	50
	Test Plug	1492-P10TPE	50

Marking Systems ⁽²⁾		
ClearPlot Basic Marker Cards	1492-MR5X8 (120/card)	5 cards
ClearMultiprint Markers	1492-MT5X8 (800/roll)	1 roll

- (1) Available in orange, to order remove the -B suffix from the catalog number. Example for an orange 2-pole center jumper, the catalog number will be 1492-CJP3-2.
- (2) Use either two marker cards or two roll markers per terminal block.

Wiring Diagram

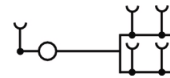

IMPORTANT See [page 72](#) for ferrule selection.

1492-P10PD3S-1RE

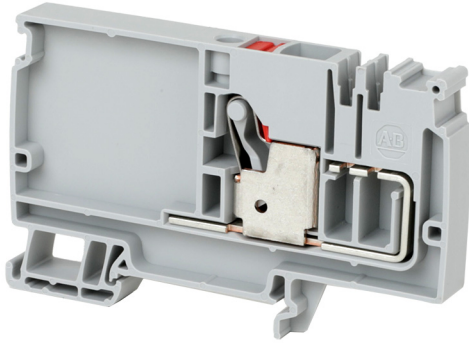

Terminal Blocks—Dimensions (W x H x L): 10 x 54 x 89 mm		
Color	Cat. No.	Pkg. Qty.
 Grey	1492-P10PD3S-1RE	20

Specifications — Control Power Distribution Terminal Block			
Certifications	 /CSA	IEC	ATEX
Voltage Rating	600V AC/DC	800V AC/DC	690V AC/DC
Maximum Current	51 A	57 A	45 A
Wire Range (Rated Cross Section)	20...6 AWG	10 mm ²	10 mm ²
Wire Strip Length	0.71 (18 mm)		
Density	30 pcs/ft (100 pcs/m)		
Housing Temperature Range	-76...266°F (-60...130 °C)		

Accessories	Cat. No.	Pkg. Qty.	
Mounting Rails, End Barriers, End Anchors and Retainers			
Mounting Rail 1 m Symmetrical DIN	Steel	199-DR1	10
	Aluminum	1492-DR5	10
	Hi-Rise (Aluminum)	1492-DR6	2
	Angled (Steel)	1492-DR7	2
End Barriers	Grey	1492-EBP10PD3	20
End Retainer		1492-ERL35	20
End Anchor DIN Rail	Normal Duty	1492-EAJ35	100
	Heavy Duty	1492-EAHJ35	50
	Normal Duty	1492-EAP35	50

Accessories	Cat. No.	Pkg. Qty.
Center Jumpers⁽¹⁾		
2-pole	1492-CJP3-2-RE	60
3-pole	1492-CJP3-3-RE	20
4-pole	1492-CJP3-4-RE	
5-pole	1492-CJP3-5-RE	
6-pole	1492-CJP3-6-RE	
7-pole	1492-CJP3-7-RE	
8-pole	1492-CJP3-8-RE	
9-pole	1492-CJP3-9-RE	
10-pole	1492-CJP3-10-RE	
20-pole	1492-CJP3-20-RE	
50-pole	1492-CJP3-50-RE	

Test Plugs			
Test Plugs	Start Test Plug	1492-PTPS	50
	Test Plug	1492-P10TPE	50

Marking Systems ⁽²⁾		
ClearPlot Basic Marker Cards	1492-MRSX8 (120/card)	5 cards
ClearMultiprint Markers	1492-MT5X8 (800/roll)	1 roll

(1) Available in orange, to order remove the -RE suffix from the catalog number. Example for an orange 2-pole center jumper, the catalog number will be 1492-CJP3-2.

(2) Use either two marker cards or two roll markers per terminal block.

Wiring Diagram

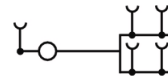

IMPORTANT See [page 72](#) for ferrule selection.

1492-PG10PD3S

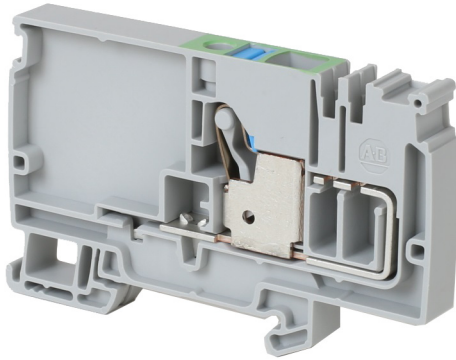

Terminal Blocks—Dimensions (W x H x L): 10 x 54 x 89 mm		
Color	Cat. No.	Pkg. Qty.
 Grey	1492-PG10PD3S	20

Specifications — Control Power Distribution with Grounding Terminal Block			
Certifications	UL /CSA	IEC	ATEX
Voltage Rating	600V AC/DC	800V AC/DC	690V AC/DC
Wire Range (Rated Cross Section)	20...6 AWG	10 mm ²	10 mm ²
Wire Strip Length	0.71 (18 mm)		
Density	30 pcs/ft (100 pcs/m)		
Housing Temperature Range	-76...266°F (-60...130 °C)		

Accessories	Cat. No.	Pkg. Qty.
-------------	----------	-----------

Mounting Rails, End Barriers, End Anchors and Retainers			
Mounting Rail 1 m Symmetrical DIN	Steel	199-DR1	10
	Aluminum	1492-DR5	10
	Hi-Rise (Aluminum)	1492-DR6	2
	Angled (Steel)	1492-DR7	2
End Barriers	Grey	1492-EBP10PD3	20
End Retainer		1492-ERL35	20
End Anchor DIN Rail	Normal Duty	1492-EAJ35	100
	Heavy Duty	1492-EAHJ35	50
	Normal Duty	1492-EAP35	50

Accessories	Cat. No.	Pkg. Qty.
Center Jumpers⁽¹⁾		
2-pole	1492-CJP3-2-B	60
3-pole	1492-CJP3-3-B	20
4-pole	1492-CJP3-4-B	
5-pole	1492-CJP3-5-B	
6-pole	1492-CJP3-6-B	
7-pole	1492-CJP3-7-B	
8-pole	1492-CJP3-8-B	
9-pole	1492-CJP3-9-B	
10-pole	1492-CJP3-10-B	
20-pole	1492-CJP3-20-B	
50-pole	1492-CJP3-50-B	

Test Plugs			
Test Plugs	Start Test Plug	1492-PTPS	50
	Test Plug	1492-P10TPE	50

Marking Systems ⁽²⁾		
ClearPlot Basic Marker Cards	1492-MR5X8 (120/card)	5 cards
ClearMultiprint Markers	1492-MT5X8 (800/roll)	1 roll

- (1) Available in orange, to order remove the -B suffix from the catalog number. Example for an orange 2-pole center jumper, the catalog number will be 1492-CJP3-2.
- (2) Use either two marker cards or two roll markers per terminal block.

Wiring Diagram

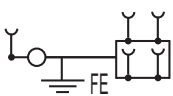

IMPORTANT See [page 72](#) for ferrule selection.

1492-P10PD3E- 5B

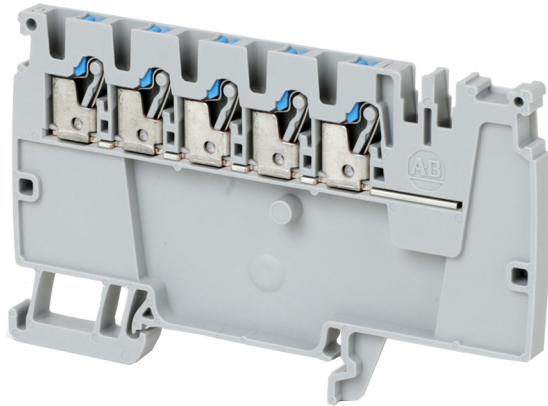

Terminal Blocks—Dimensions (W x H x L): 5.1 x 54x 89 mm			
Color		Cat. No.	Pkg. Qty.
	Grey	1492-P10PD3E-5B	50

Specifications — Control Power Distribution Terminal Block			
Certifications	 /CSA	IEC	ATEX
Voltage Rating	600V AC/DC	800V AC/DC	690V AC/DC
Maximum Current	20 A	24 A	20 A
Wire Range (Rated Cross Section)	28...12 AWG	2.5 mm ²	2.5 mm ²
Wire Strip Length	0.4 in. (10 mm)		
Density	59 pcs/ft (196 pcs/m)		
Housing Temperature Range	-76...266°F (-60...130 °C)		

Accessories	Cat. No.	Pkg. Qty.	
Mounting Rails, End Barriers, End Anchors and Retainers			
Mounting Rail 1 m Symmetrical DIN	Steel	199-DR1	10
	Aluminum	1492-DR5	10
	Hi-Rise (Aluminum)	1492-DR6	2
	Angled (Steel)	1492-DR7	2
End Barriers	Grey	1492-EBP10PD3	20
End Retainer		1492-ERL35	20
End Anchor DIN Rail	Normal Duty	1492-EAJ35	100
	Heavy Duty	1492-EAHJ35	50
	Normal Duty	1492-EAP35	50

Accessories	Cat. No.	Pkg. Qty.
Center Jumpers⁽¹⁾		
2-pole	1492-CJP3-2-B	60
3-pole	1492-CJP3-3-B	20
4-pole	1492-CJP3-4-B	
5-pole	1492-CJP3-5-B	
6-pole	1492-CJP3-6-B	
7-pole	1492-CJP3-7-B	
8-pole	1492-CJP3-8-B	
9-pole	1492-CJP3-9-B	
10-pole	1492-CJP3-10-B	
20-pole	1492-CJP3-20-B	
50-pole	1492-CJP3-50-B	

Marking Systems		
ClearPlot Basic Marker Cards	1492-MRSX8 (120/card)	5 cards
ClearMultiprint Markers	1492-MT5X8 (800/roll)	1 roll

(1) Available in orange, to order remove the -B suffix from the catalog number. Example for an orange 2-pole center jumper, the catalog number will be 1492-CJP3-2.

Wiring Diagram

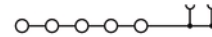

IMPORTANT See [page 69](#) for ferrule selection.

1492-P10PD3E-5RE

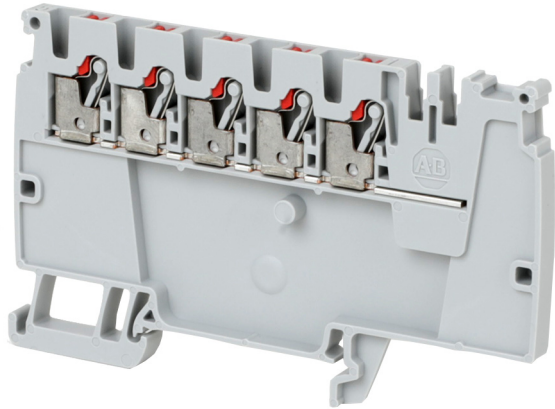

Terminal Blocks—Dimensions (W x H x L): 5.1 x 54x 89 mm			
Color		Cat. No.	Pkg. Qty.
	Grey	1492-P10PD3E-5RE	50

Specifications — Control Power Distribution Terminal Block			
Certifications	UL /CSA	IEC	ATEX
Voltage Rating	600V AC/DC	800V AC/DC	690V AC/DC
Maximum Current	20 A	24 A	20 A
Wire Range (Rated Cross Section)	28...12 AWG	2.5 mm ²	2.5 mm ²
Wire Strip Length	0.4 in. (10 mm)		
Density	59 pcs/ft (196 pcs/m)		
Housing Temperature Range	-76...266°F (-60...130 °C)		

Accessories		Cat. No.	Pkg. Qty.
Mounting Rails, End Barriers, End Anchors and Retainers			
Mounting Rail 1 m Symmetrical DIN	Steel	199-DR1	10
	Aluminum	1492-DR5	10
	Hi-Rise (Aluminum)	1492-DR6	2
	Angled (Steel)	1492-DR7	2
End Barriers	Grey	1492-EBP10PD3	20
End Retainer		1492-ERL35	20
End Anchor DIN Rail	Normal Duty	1492-EAJ35	100
	Heavy Duty	1492-EAHJ35	50
	Normal Duty	1492-EAP35	50

Accessories		Cat. No.	Pkg. Qty.
Center Jumpers⁽¹⁾			
2-pole	Red	1492-CJP3-2-RE	60
3-pole		1492-CJP3-3-RE	20
4-pole		1492-CJP3-4-RE	
5-pole		1492-CJP3-5-RE	
6-pole		1492-CJP3-6-RE	
7-pole		1492-CJP3-7-RE	
8-pole		1492-CJP3-8-RE	
9-pole		1492-CJP3-9-RE	
10-pole		1492-CJP3-10-RE	
20-pole		1492-CJP3-20-RE	
50-pole		1492-CJP3-50-RE	

Marking Systems		
ClearPlot Basic Marker Cards	1492-MRSX8 (120/card)	5 cards
ClearMultiprint Markers	1492-MT5X8 (800/roll)	1 roll

(1) Available in orange, to order remove the -RE suffix from the catalog number. Example for an orange 2-pole center jumper, the catalog number will be 1492-CJP3-2.

Wiring Diagram

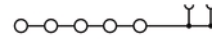

IMPORTANT See [page 69](#) for ferrule selection.

1492-P10PD3S-1B1RE

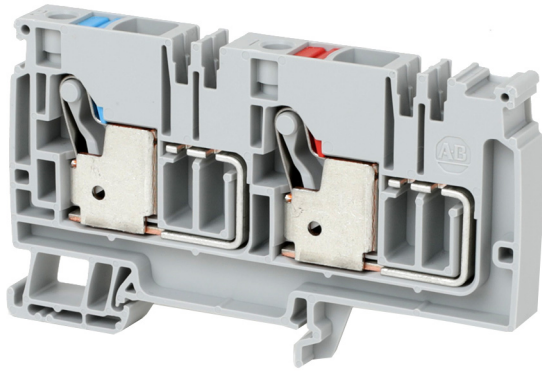

Terminal Blocks—Dimensions (W x H x L): 10 x 54 x 94 mm		
Color	Cat. No.	Pkg. Qty.
■ Grey	1492-P10PD3S-1B1RE	20

Specifications — Control Power Distribution Terminal Block			
Certifications	UL /CSA	IEC	ATEX
Voltage Rating	600V AC/DC	500V AC/DC	352V AC/DC
Maximum Current	51 A	41 A	45 A
Wire Range (Rated Cross Section)	20...6 AWG	10 mm ²	10 mm ²
Wire Strip Length	0.71 in. (18 mm)		
Density	30 pcs/ft (100 pcs/m)		
Housing Temperature Range	-76...266°F (-60...130 °C)		

Accessories		Cat. No.	Pkg. Qty.
Mounting Rails, End Barriers, End Anchors and Retainers			
Mounting Rail 1 m Symmetrical DIN	Steel	199-DR1	10
	Aluminum	1492-DR5	10
	Hi-Rise (Aluminum)	1492-DR6	2
	Angled (Steel)	1492-DR7	2
End Barriers	Grey	1492-EBP10PD3-BRE	20
End Retainer		1492-ERL35	20
End Anchor DIN Rail	Normal Duty	1492-EAJ35	100
	Heavy Duty	1492-EAHJ35	50
	Normal Duty	1492-EAP35	50

Accessories		Cat. No.	Pkg. Qty.
Center Jumpers⁽¹⁾			
2-pole	Blue	1492-CJP3-2-B	60
	Red	1492-CJP3-2-RE	60
3-pole	Blue	1492-CJP3-3-B	20
	Red	1492-CJP3-3-RE	20
4-pole	Blue	1492-CJP3-4-B	20
	Red	1492-CJP3-4-RE	20
5-pole	Blue	1492-CJP3-5-B	20
	Red	1492-CJP3-5-RE	20
6-pole	Blue	1492-CJP3-6-B	20
	Red	1492-CJP3-6-RE	20
7-pole	Blue	1492-CJP3-7-B	20
	Red	1492-CJP3-7-RE	20
8-pole	Blue	1492-CJP3-8-B	20
	Red	1492-CJP3-8-RE	20
9-pole	Blue	1492-CJP3-9-B	20
	Red	1492-CJP3-9-RE	20
10-pole	Blue	1492-CJP3-10-B	20
	Red	1492-CJP3-10-RE	20
20-pole	Blue	1492-CJP3-20-B	20
	Red	1492-CJP3-20-RE	20
50-pole	Blue	1492-CJP3-50-B	20
	Red	1492-CJP3-50-RE	20

Test Plugs			
Test Plugs	Start Test Plug	1492-PTPS	50
	Test Plug	1492-P10TPE	50

Marking Systems ⁽²⁾		
ClearPlot Basic Marker Cards	1492-MRSX8 (120/card)	5 cards
ClearMultiprint Markers	1492-MTSX8 (800/roll)	1 roll

(1) Available in orange, to order remove the -B or RE suffix from the catalog number. Example for an orange 2-pole center jumper, the catalog number will be 1492-CJP3-2.

(2) Use either two marker cards or two roll markers per terminal block.

Wiring Diagram

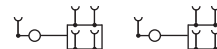

IMPORTANT See [page 72](#) for ferrule selection.

1492-P10PD3S-1RE1G

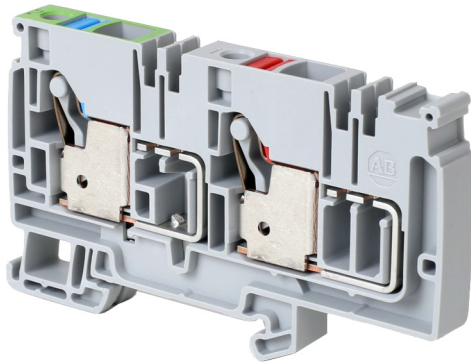

Terminal Blocks—Dimensions (W x H x L): 10 x 54 x 94 mm		
Color	Cat. No.	Pkg. Qty.
■ Grey	1492-P10PD3S-1RE1G	20

Specifications — Control Power Distribution with Grounding Terminal Block			
Certifications	UL /CSA	IEC	ATEX
Voltage Rating	600V AC/DC	500V AC/DC	352V AC/DC
Maximum Current	51 A	41 A	45 A
Wire Range (Rated Cross Section)	20...6 AWG	10 mm ²	10 mm ²
Wire Strip Length	0.71 in. (18 mm)		
Density	30 pcs/ft (100 pcs/m)		
Housing Temperature Range	-76...266°F (-60...130 °C)		

Accessories	Cat. No.	Pkg. Qty.
-------------	----------	-----------

Mounting Rails, End Barriers, End Anchors and Retainers			
Mounting Rail 1 m Symmetrical DIN	Steel	199-DR1	10
	Aluminum	1492-DR5	10
	Hi-Rise (Aluminum)	1492-DR6	2
	Angled (Steel)	1492-DR7	2
End Barriers	Grey	1492-EBP10PD3-BRE	20
End Retainer		1492-ERL35	20
End Anchor DIN Rail	Normal Duty	1492-EAJ35	100
	Heavy Duty	1492-EAHJ35	50
	Normal Duty	1492-EAP35	50

Accessories		Cat. No.	Pkg. Qty.
Center Jumpers⁽¹⁾			
2-pole	Blue	1492-CJP3-2-B	60
	Red	1492-CJP3-2-RE	60
3-pole	Blue	1492-CJP3-3-B	20
	Red	1492-CJP3-3-RE	20
4-pole	Blue	1492-CJP3-4-B	20
	Red	1492-CJP3-4-RE	20
5-pole	Blue	1492-CJP3-5-B	20
	Red	1492-CJP3-5-RE	20
6-pole	Blue	1492-CJP3-6-B	20
	Red	1492-CJP3-6-RE	20
7-pole	Blue	1492-CJP3-7-B	20
	Red	1492-CJP3-7-RE	20
8-pole	Blue	1492-CJP3-8-B	20
	Red	1492-CJP3-8-RE	20
9-pole	Blue	1492-CJP3-9-B	20
	Red	1492-CJP3-9-RE	20
10-pole	Blue	1492-CJP3-10-B	20
	Red	1492-CJP3-10-RE	20
20-pole	Blue	1492-CJP3-20-B	20
	Red	1492-CJP3-20-RE	20
50-pole	Blue	1492-CJP3-50-B	20
	Red	1492-CJP3-50-RE	20

Test Plugs			
Test Plugs	Start Test Plug	1492-PTPS	50
	Test Plug	1492-P10TPE	50

Marking Systems ⁽²⁾		
ClearPlot Basic Marker Cards	1492-MRSX8 (120/card)	5 cards
ClearMultiprint Markers	1492-MTSX8 (800/roll)	1 roll

(1) Available in orange, to order remove the -B or RE suffix from the catalog number. Example for an orange 2-pole center jumper, the catalog number will be 1492-CJP3-2.

(2) Use either two marker cards or two roll markers per terminal block.

Wiring Diagram

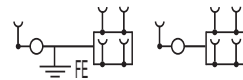

IMPORTANT See [page 72](#) for ferrule selection.

1492-P10PD3E-2B2RE

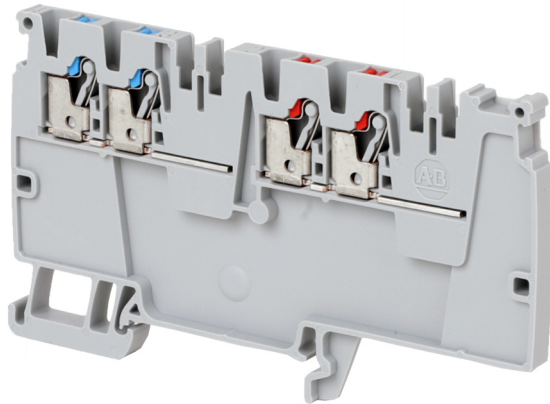

Terminal Blocks—Dimensions (W x H x L): 5.1 x 54x 94 mm		
Color	Cat. No.	Pkg. Qty.
■ Grey	1492-P10PD3E-2B2RE	20

Specifications — Control Power Distribution Terminal Block			
Certifications	UL /CSA	IEC	ATEX
Voltage Rating	150V AC/DC	500V AC/DC	352V AC/DC
Current Rating	20 A	24 A	20 A
Wire Range (Rated Cross Section)	28...12 AWG	2.5 mm ²	2.5 mm ²
Wire Strip Length	0.4 in (10 mm)		
Density	59 pcs/ft (196 pcs/m)		
Housing Temperature Range	-76...266°F (-60...130 °C)		

Accessories		Cat. No.	Pkg. Qty.
Mounting Rails, End Barriers, End Anchors and Retainers			
Mounting Rail 1 m Symmetrical DIN	Steel	199-DR1	10
	Aluminum	1492-DR5	10
	Hi-Rise (Aluminum)	1492-DR6	2
	Angled (Steel)	1492-DR7	2
End Barriers	Grey	1492-EBP10PD3-BRE	20
End Retainer		1492-ERL35	20
End Anchor DIN Rail	Normal Duty	1492-EAJ35	100
	Heavy Duty	1492-EAHJ35	50
	Normal Duty	1492-EAP35	50

Accessories		Cat. No.	Pkg. Qty.
Center Jumpers⁽¹⁾			
2-pole	Blue	1492-CJP3-2-B	60
	Red	1492-CJP3-2-RE	60
3-pole	Blue	1492-CJP3-3-B	20
	Red	1492-CJP3-3-RE	20
4-pole	Blue	1492-CJP3-4-B	20
	Red	1492-CJP3-4-RE	20
5-pole	Blue	1492-CJP3-5-B	20
	Red	1492-CJP3-5-RE	20
6-pole	Blue	1492-CJP3-6-B	20
	Red	1492-CJP3-6-RE	20
7-pole	Blue	1492-CJP3-7-B	20
	Red	1492-CJP3-7-RE	20
8-pole	Blue	1492-CJP3-8-B	20
	Red	1492-CJP3-8-RE	20
9-pole	Blue	1492-CJP3-9-B	20
	Red	1492-CJP3-9-RE	20
10-pole	Blue	1492-CJP3-10-B	20
	Red	1492-CJP3-10-RE	20
20-pole	Blue	1492-CJP3-20-B	20
	Red	1492-CJP3-20-RE	20
50-pole	Blue	1492-CJP3-50-B	20
	Red	1492-CJP3-50-RE	20

Marking Systems		
ClearPlot Basic Marker Cards	1492-MR5X8 (120/card)	5 cards
ClearMultiprint Markers	1492-MT5X8 (800/roll)	1 roll

(1) Available in orange, to order remove the -B or RE suffix from the catalog number. Example for an orange 2-pole center jumper, the catalog number will be 1492-CJP3-2.

Wiring Diagram



IMPORTANT See [page 69](#) for ferrule selection.

Single-level Flex Plug-in Terminal Blocks

1492-P31P

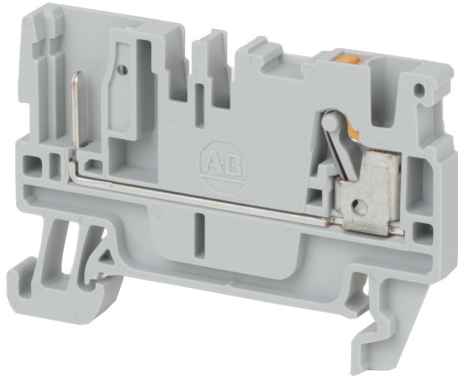

Terminal Blocks—Dimensions (W x H x L): 5.1 x 36.5x 55mm			
Color	Cat. No.	Pkg. Qty.	
Grey	1492-P31P	100	
Blue	1492-P31P-B	100	

Specifications — Single-level Flex Plug-in Terminal Block			
Certifications	UL /CSA	IEC	ATEX
Voltage Rating	600V AC/DC	800V AC/DC	800V AC/DC
Maximum Current	20 A	24 A	20 A
Wire Range (Rated Cross Section)	28...12 AWG	2.5 mm ²	2.5 mm ²
Wire Strip Length	0.4 in (10 mm)		
Density	59 pcs/ft (196 pcs/m)		
Housing Temperature Range	-76...266°F (-60...130 °C)		

Accessories		Cat. No.	Pkg Qty.
Mounting Rails, End Barriers, End Anchors and Retainers			
Mounting Rail 1 m Symmetrical DIN	Steel	199-DR1	10
	Aluminum	1492-DR5	10
	Hi-Rise (Aluminum)	1492-DR6	2
	Angled (Steel)	1492-DR7	2
End Barriers	Grey	1492-EBP3	50
	Blue	1492-EBP3-B	50
	Yellow	1492-EBP3-Y	50
End Retainer		1492-ERL35	20
End Anchor DIN Rail	Normal Duty	1492-EAJ35	100
	Heavy Duty	1492-EAHJ35	50
	Normal Duty	1492-EAP35	50

Accessories		Cat. No.	Pkg Qty.
Center Jumpers⁽¹⁾			
2-pole	Orange	1492-CJP3-2	20
3-pole		1492-CJP3-3	
4-pole		1492-CJP3-4	
5-pole		1492-CJP3-5	
6-pole		1492-CJP3-6	
7-pole		1492-CJP3-7	
8-pole		1492-CJP3-8	
9-pole		1492-CJP3-9	
10-pole		1492-CJP3-10	
20-pole		1492-CJP3-20	
50-pole		1492-CJP3-50	

Plugs and Plug Accessories			
Start Plug ⁽²⁾	Grey	1492-P3SSTP	50
	Blue	1492-P3SSTP-B	
	Green	1492-P3SSTP-G	
Middle Plug	Grey	1492-P3MSTP	
	Blue	1492-P3MSTP-B	
	Green	1492-P3MSTP-G	
End Plug	Grey	1492-P3ESTP	
	Blue	1492-P3ESTP-B	
	Green	1492-P3ESTP-G	
Plug End Barrier	Grey	1492-P3STPEB	
Coding Element	Orange	1492-P3STPCE	
Protective Cover	Orange	1492-P3STPPC	
Locking Element	Orange	1492-P3STPLE	25

Marking Systems			
ClearPlot Basic Marker Cards		1492-MR5X8 (120/card)	5 cards
ClearMultiprint Markers		1492-MT5X8 (800/roll)	1 roll

- (1) Available in orange as standard, to order other colors add the appropriate suffix to the catalog number listed: Blue =B, Red = RE. Example for a red 2-pole center jumper, the catalog number will be 1492-CJP3-2-RE.
- (2) Assembly option available, order catalog number: 1492-P3STP for (1) start plug and (1) plug end barrier.

Wiring Diagram



IMPORTANT See [page 69](#) for ferrule selection.

1492-PG31P

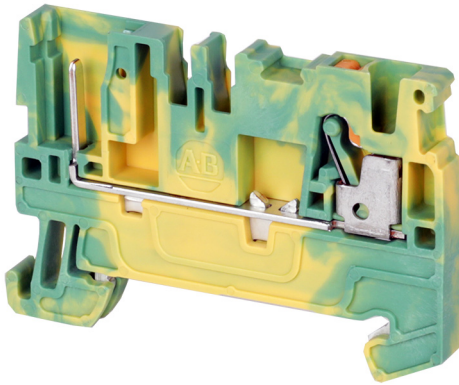

Terminal Blocks—Dimensions (W x H x L): 5.1 x 36.5 x 55 mm			
Color	Cat. No.	Pkg. Qty.	
 Green/Yellow	1492-PG31P	100	

Specifications — Single-level Flex Plug-in Grounding Terminal Block			
Certifications	UL /CSA	IEC	ATEX
Maximum Voltage	600V AC/DC	800V AC/DC	800V AC/DC
Wire Range (Rated Cross Section)	28...12 AWG	2.5 mm ²	2.5 mm ²
Wire Strip Length	0.4 in (10 mm)		
Density	59 pcs/ft (196 pcs/m)		
Housing Temperature Range	-76...266°F (-60...130 °C)		

Accessories	Cat. No.	Pkg. Qty.	
Mounting Rails, End Barriers, End Anchors and Retainers			
Mounting Rail 1 m Symmetrical DIN	Steel	199-DR1	10
	Aluminum	1492-DR5	10
	Hi-Rise (Aluminum)	1492-DR6	2
	Angled (Steel)	1492-DR7	2
End Barriers	Grey	1492-EBP3	50
	Blue	1492-EBP3-B	50
	Yellow	1492-EBP3-Y	50
End Retainer	1492-ERL35	20	
End Anchor DIN Rail	Normal Duty	1492-EAJ35	100
	Heavy Duty	1492-EAHJ35	50
	Normal Duty	1492-EAP35	50

Accessories	Cat. No.	Pkg. Qty.	
Center Jumpers⁽¹⁾			
2-pole	1492-CJP3-2	60	
3-pole	1492-CJP3-3	20	
4-pole	1492-CJP3-4		
5-pole	1492-CJP3-5		
6-pole	1492-CJP3-6		
7-pole	1492-CJP3-7		
8-pole	1492-CJP3-8		
9-pole	1492-CJP3-9		
10-pole	1492-CJP3-10		
20-pole	1492-CJP3-20		
50-pole	1492-CJP3-50		

Plugs and Plug Accessories			
Start Plug ⁽²⁾	Grey	1492-P3SSTP	50
	Blue	1492-P3SSTP-B	
	Green	1492-P3SSTP-G	
Middle Plug	Grey	1492-P3MSTP	
	Blue	1492-P3MSTP-B	
	Green	1492-P3MSTP-G	
End Plug	Grey	1492-P3ESTP	
	Blue	1492-P3ESTP-B	
	Green	1492-P3ESTP-G	
Plug End Barrier	Grey	1492-P3STPEB	
Coding Element	Orange	1492-P3STPCE	
Protective Cover	Orange	1492-P3STPPC	
Locking Element	Orange	1492-P3STPLE	25

Marking Systems		
ClearPlot Basic Marker Cards	1492-MRSX8 (120/card)	5 cards
ClearMultiprint Markers	1492-MTSX8 (800/roll)	1 roll

- (1) Available in orange as standard, to order other colors add the appropriate suffix to the catalog number listed: Blue =B, Red = RE. Example for a red 2-pole center jumper, the catalog number will be 1492-CJP3-2-RE.
- (2) Assembly option available, order catalog number: 1492-P3STP for (1) start plug and (1) plug end barrier.

Wiring Diagram

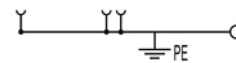

IMPORTANT See [page 69](#) for ferrule selection.

Double-level Flex Plug-in Terminal Blocks

1492-PD32P

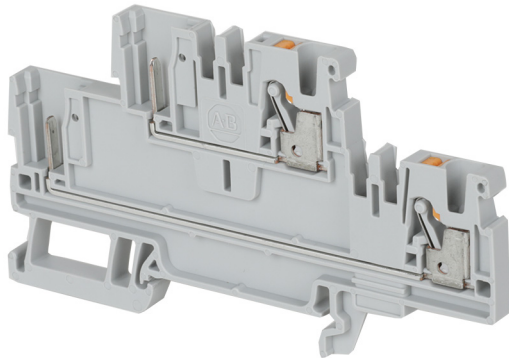

Terminal Blocks—Dimensions (W x H x L): 5.1 x 50.5 x 91 mm		
Color	Cat. No.	Pkg. Qty.
Grey	1492-PD32P	50
Blue	1492-PD32P-B	50

Specifications — Double-level Flex Plug-in Terminal Block			
Certifications	/CSA	IEC	ATEX
Voltage Rating	600V AC/DC	800V AC/DC	800V AC/DC
Maximum Current	20 A	24 A	20 A
Wire Range (Rated Cross Section)	28...12 AWG	2.5 mm ²	2.5 mm ²
Wire Strip Length	0.4 in (10 mm)		
Density	59 pcs/ft (196 pcs/m)		
Housing Temperature Range	-76...266°F (-60...130 °C)		

Accessories	Cat. No.	Pkg Qty.	
Mounting Rails, End Barriers, End Anchors and Retainers			
Mounting Rail 1 m Symmetrical DIN	Steel	199-DR1	10
	Aluminum	1492-DR5	10
	Hi-Rise (Aluminum)	1492-DR6	2
	Angled (Steel)	1492-DR7	2
End Barriers	Grey	1492-EBPD3	20
	Blue	1492-EBPD3-B	20
	Yellow	1492-EBPD3-Y	20
End Retainer		1492-ERL35	20
End Anchor DIN Rail	Normal Duty	1492-EAJ35	100
	Heavy Duty	1492-EAHJ35	50
	Normal Duty	1492-EAP35	50

Accessories	Cat. No.	Pkg Qty.
Center Jumpers⁽¹⁾		
2-pole	1492-CJP3-2	60
3-pole	1492-CJP3-3	20
4-pole	1492-CJP3-4	
5-pole	1492-CJP3-5	
6-pole	1492-CJP3-6	
7-pole	1492-CJP3-7	
8-pole	1492-CJP3-8	
9-pole	1492-CJP3-9	
10-pole	1492-CJP3-10	
20-pole	1492-CJP3-20	
50-pole	1492-CJP3-50	

Plugs and Plug Accessories			
Start Plug ⁽²⁾	Grey	1492-P3SSTP	50
	Blue	1492-P3SSTP-B	
	Green	1492-P3SSTP-G	
Middle Plug	Grey	1492-P3MSTP	
	Blue	1492-P3MSTP-B	
	Green	1492-P3MSTP-G	
End Plug	Grey	1492-P3ESTP	
	Blue	1492-P3ESTP-B	
	Green	1492-P3ESTP-G	
Plug End Barrier	Grey	1492-P3STPEB	
Coding Element	Orange	1492-P3STPCE	
Protective Cover	Orange	1492-P3STPPC	
Locking Element	Orange	1492-P3STPLE	25

Marking Systems		
ClearPlot Basic Marker Cards	1492-MRSX8 (120/card)	5 cards
ClearMultiprint Markers	1492-MTSX8 (800/roll)	1 roll

- (1) Available in orange as standard, to order other colors add the appropriate suffix to the catalog number listed: Blue =B, Red = RE. Example for a red 2-pole center jumper, the catalog number will be 1492-CJP3-2-RE.
- (2) Assembly option available, order catalog number: 1492-P3STP for (1) start plug and (1) plug end barrier.

Wiring Diagram

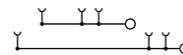

IMPORTANT See [page 69](#) for ferrule selection.

1492-PD32PC

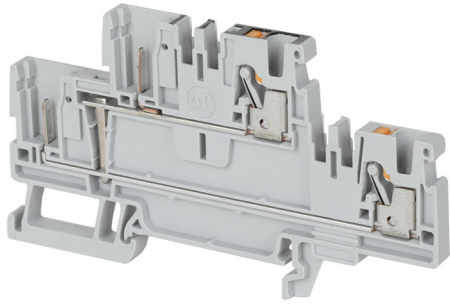

Terminal Blocks—Dimensions (W x H x L): 5.1 x 50.5 x 91 mm

Color	Cat. No.	Pkg. Qty.
Grey	1492-PD32PC	50
Blue	1492-PD32PC-B	50

Specifications — Double-level Flex Plug-in Terminal Block

Certifications	UL/CSA	IEC	ATEX
Voltage Rating	600V AC/DC	800V AC/DC	800V AC/DC
Maximum Current	20 A	24 A	20 A
Wire Range (Rated Cross Section)	28...12 AWG	2.5 mm ²	2.5 mm ²
Wire Strip Length	0.4 in (10 mm)		
Density	59 pcs/ft (196 pcs/m)		
Housing Temperature Range	-76...266°F (-60...130 °C)		

Accessories	Cat. No.	Pkg Qty.
-------------	----------	----------

Mounting Rails, End Barriers, End Anchors and Retainers

Mounting Rail 1 m Symmetrical DIN	Steel	199-DR1	10
	Aluminum	1492-DR5	10
	Hi-Rise (Aluminum)	1492-DR6	2
	Angled (Steel)	1492-DR7	2
End Barriers	Grey	1492-EBPD3	20
	Blue	1492-EBPD3-B	20
	Yellow	1492-EBPD3-Y	20
End Retainer		1492-ERL35	20
End Anchor DIN Rail	Normal Duty	1492-EAJ35	100
	Heavy Duty	1492-EAHJ35	50
	Normal Duty	1492-EAP35	50

Accessories	Cat. No.	Pkg Qty.
Center Jumpers⁽¹⁾		
2-pole	1492-CJP3-2	60
3-pole	1492-CJP3-3	20
4-pole	1492-CJP3-4	
5-pole	1492-CJP3-5	
6-pole	1492-CJP3-6	
7-pole	1492-CJP3-7	
8-pole	1492-CJP3-8	
9-pole	1492-CJP3-9	
10-pole	1492-CJP3-10	
20-pole	1492-CJP3-20	
50-pole	1492-CJP3-50	

Plugs and Plug Accessories

Start Plug ⁽²⁾	Grey	1492-P3SSTP	50
	Blue	1492-P3SSTP-B	
	Green	1492-P3SSTP-G	
Middle Plug	Grey	1492-P3MSTP	
	Blue	1492-P3MSTP-B	
	Green	1492-P3MSTP-G	
End Plug	Grey	1492-P3ESTP	
	Blue	1492-P3ESTP-B	
	Green	1492-P3ESTP-G	
Plug End Barrier	Grey	1492-P3STPEB	
Coding Element	Orange	1492-P3STPCE	
Protective Cover	Orange	1492-P3STPPC	
Locking Element	Orange	1492-P3STPLE	25

Marking Systems

ClearPlot Basic Marker Cards	1492-MRSX8 (120/card)	5 cards
ClearMultiprint Markers	1492-MTSX8 (800/roll)	1 roll

(1) Available in orange as standard, to order other colors add the appropriate suffix to the catalog number listed: Blue =B, Red = RE. Example for a red 2-pole center jumper, the catalog number will be 1492-CJP3-2-RE.
 (2) Assembly option available, order catalog number: 1492-P3STP for (1) start plug and (1) plug end barrier.

Wiring Diagram

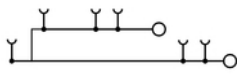

IMPORTANT See [page 69](#) for ferrule selection.

1492-PDG32P

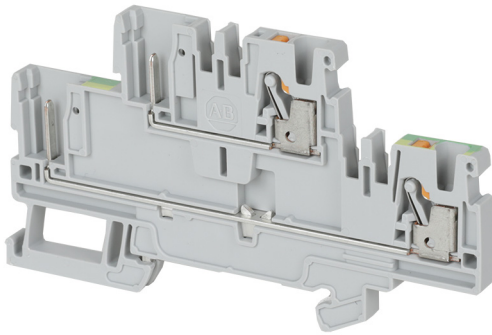

Terminal Blocks—Dimensions (W x H x L): 5.1 x 50.5 x 91 mm		
Color	Cat. No.	Pkg. Qty.
 Grey	1492-PDG32P	50

Specifications — Double-level Flex Plug-in with Grounding Terminal Block			
Certifications	 /CSA	IEC	ATEX
Voltage Rating	600V AC/DC	800V AC/DC	800V AC/DC
Maximum Current	20 A	24 A	20 A
Wire Range (Rated Cross Section)	28...12 AWG	2.5 mm ²	2.5 mm ²
Wire Strip Length	0.4 in (10 mm)		
Density	59 pcs/ft (196 pcs/m)		
Housing Temperature Range	-76...266°F (-60...130 °C)		

Accessories	Cat. No.	Pkg Qty.	
Mounting Rails, End Barriers, End Anchors and Retainers			
Mounting Rail 1 m Symmetrical DIN	Steel	199-DR1	10
	Aluminum	1492-DR5	10
	Hi-Rise (Aluminum)	1492-DR6	2
	Angled (Steel)	1492-DR7	2
End Barriers	Grey	1492-EBPD3	20
	Blue	1492-EBPD3-B	20
	Yellow	1492-EBPD3-Y	20
End Retainer	1492-ERL35	20	
End Anchor DIN Rail	Normal Duty	1492-EAJ35	100
	Heavy Duty	1492-EAHJ35	50
	Normal Duty	1492-EAP35	50

Accessories	Cat. No.	Pkg Qty.
Center Jumpers⁽¹⁾		
2-pole	1492-CJP3-2	60
3-pole	1492-CJP3-3	20
4-pole	1492-CJP3-4	
5-pole	1492-CJP3-5	
6-pole	1492-CJP3-6	
7-pole	1492-CJP3-7	
8-pole	1492-CJP3-8	
9-pole	1492-CJP3-9	
10-pole	1492-CJP3-10	
20-pole	1492-CJP3-20	
50-pole	1492-CJP3-50	

Plugs and Plug Accessories			
Start Plug ⁽²⁾	Grey	1492-P3SSTP	50
	Blue	1492-P3SSTP-B	
	Green	1492-P3SSTP-G	
Middle Plug	Grey	1492-P3MSTP	
	Blue	1492-P3MSTP-B	
	Green	1492-P3MSTP-G	
End Plug	Grey	1492-P3ESTP	
	Blue	1492-P3ESTP-B	
	Green	1492-P3ESTP-G	
Plug End Barrier	Grey	1492-P3STPEB	
Coding Element	Orange	1492-P3STPCE	
Protective Cover	Orange	1492-P3STPPC	
Locking Element	Orange	1492-P3STPLE	25

Marking Systems		
ClearPlot Basic Marker Cards	1492-MR5X8 (120/card)	5 cards
ClearMultiprint Markers	1492-MT5X8 (800/roll)	1 roll

- (1) Available in orange as standard, to order other colors add the appropriate suffix to the catalog number listed: Blue =B, Red = RE. Example for a red 2-pole center jumper, the catalog number will be 1492-CJP3-2-RE.
- (2) Assembly option available, order catalog number: 1492-P3STP for (1) start plug and (1) plug end barrier.

Wiring Diagram

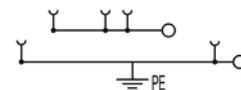

IMPORTANT See [page 69](#) for ferrule selection.

1492-PDG32PC

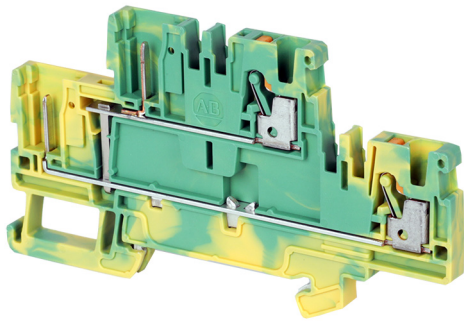

Terminal Blocks—Dimensions (W x H x L): 5.1 x 50.5 x 91 mm			
Color		Cat. No.	Pkg. Qty.
	Green/Yellow	1492-PDG32PC	50

Specifications — Double-level Flex Plug-in with Grounding Terminal Block			
Certifications	UL / CSA	IEC	ATEX
Voltage Rating	600V AC/DC	800V AC/DC	800V AC/DC
Wire Range (Rated Cross Section)	28...12 AWG	2.5 mm ²	2.5 mm ²
Wire Strip Length	0.4 in (10 mm)		
Density	59 pcs/ft (196 pcs/m)		
Housing Temperature Range	-76...266°F (-60...130 °C)		

Accessories		Cat. No.	Pkg Qty.
Mounting Rails, End Barriers, End Anchors and Retainers			
Mounting Rail 1 m Symmetrical DIN	Steel	199-DR1	10
	Aluminum	1492-DR5	10
	Hi-Rise (Aluminum)	1492-DR6	2
	Angled (Steel)	1492-DR7	2
End Barriers	Grey	1492-EBPD3	20
	Blue	1492-EBPD3-B	20
	Yellow	1492-EBPD3-Y	20
End Retainer		1492-ERL35	20
End Anchor DIN Rail	Normal Duty	1492-EAJ35	100
	Heavy Duty	1492-EAHJ35	50
	Normal Duty	1492-EAP35	50

Accessories		Cat. No.	Pkg Qty.
Center Jumpers⁽¹⁾			
2-pole	Orange	1492-CJP3-2	20
3-pole		1492-CJP3-3	
4-pole		1492-CJP3-4	
5-pole		1492-CJP3-5	
6-pole		1492-CJP3-6	
7-pole		1492-CJP3-7	
8-pole		1492-CJP3-8	
9-pole		1492-CJP3-9	
10-pole		1492-CJP3-10	
20-pole		1492-CJP3-20	
50-pole	1492-CJP3-50		

Plugs and Plug Accessories			
Start Plug ⁽²⁾	Grey	1492-P3SSTP	50
	Blue	1492-P3SSTP-B	
	Green	1492-P3SSTP-G	
Middle Plug	Grey	1492-P3MSTP	
	Blue	1492-P3MSTP-B	
	Green	1492-P3MSTP-G	
End Plug	Grey	1492-P3ESTP	
	Blue	1492-P3ESTP-B	
	Green	1492-P3ESTP-G	
Plug End Barrier	Grey	1492-P3STPEB	
Coding Element	Orange	1492-P3STPCE	
Protective Cover	Orange	1492-P3STPPC	
Locking Element	Orange	1492-P3STPLE	25

Marking Systems		
ClearPlot Basic Marker Cards	1492-MRSX8 (120/card)	5 cards
ClearMultiprint Markers	1492-MTSX8 (800/roll)	1 roll

- (1) Available in orange as standard, to order other colors add the appropriate suffix to the catalog number listed: Blue =B, Red = RE. Example for a red 2-pole center jumper, the catalog number will be 1492-CJP3-2-RE.
- (2) Assembly option available, order catalog number: 1492-P3STP for (1) start plug and (1) plug end barrier.

Wiring Diagram

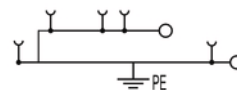

IMPORTANT See [page 69](#) for ferrule selection.

Accessory Plug-in Terminal Blocks

1492-P3P

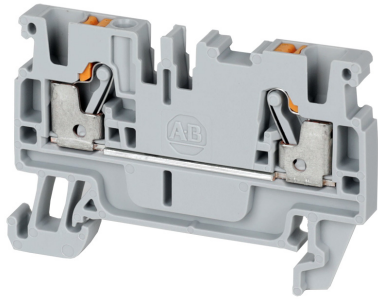

Terminal Blocks—Dimensions (W x H x L): 5.1 x 36.5 x 77.5mm		
Color	Cat. No.	Pkg. Qty.
 Grey	1492-P3P	50

Specifications — Accessory Plug-in Terminal Block		
Certifications	UL /CSA	IEC
Voltage Rating	300V AC/DC	500V AC/DC
Maximum Current	20 A	20 A
Wire Range (Rated Cross Section)	28...12 AWG	2.5 mm ²
Wire Strip Length	0.4 in. (10 mm)	
Density	59 pcs/ft (196 pcs/m)	
Housing Temperature Range	-76...266°F (-60...130 °C)	

Accessories		Cat. No.	Pkg Qty.
Mounting Rails, End Barriers, End Anchors and Retainers			
Mounting Rail 1 m Symmetrical DIN	Steel	199-DR1	10
	Aluminum	1492-DR5	10
	Hi-Rise (Aluminum)	1492-DR6	2
	Angled (Steel)	1492-DR7	2
End Barriers	Grey	1492-EBP3Q	20
	Blue	1492-EBP3Q-B	20
	Yellow	1492-EBP3Q-Y	20
End Retainer		1492-ERL35	20
End Anchor DIN Rail	Normal Duty	1492-EAJ35	100
	Heavy Duty	1492-EAHJ35	50
	Normal Duty	1492-EAP35	50

Accessories		Cat. No.	Pkg Qty.
Center Jumpers⁽¹⁾			
2-pole	Orange	1492-CJP3-2	60
3-pole		1492-CJP3-3	20
4-pole		1492-CJP3-4	
5-pole		1492-CJP3-5	
6-pole		1492-CJP3-6	
7-pole		1492-CJP3-7	
8-pole		1492-CJP3-8	
9-pole		1492-CJP3-9	
10-pole		1492-CJP3-10	
20-pole		1492-CJP3-20	
50-pole		1492-CJP3-50	

Disconnect, Component, and Fuse Plugs			
Disconnect Plug		1492-DPL	50
Component Plug		1492-CPL	50
Fuse Plugs	Without blown fuse indicator	1492-FPK2	20
	10...36V blown fuse indicator	1492-FPK224	20
	35...75V blown fuse indicator	1492-FPK248	20
	60...150V blown fuse indicator	1492-FPK2120	20
	140...250V blown fuse indicator	1492-FPK2250	20

Test Plugs			
Test Plugs	Start Test Plug	1492-PTPS	50
	Test Plug	1492-P3TPE	50

Marking Systems			
ClearPlot Basic Marker Cards		1492-MR5X8 (120/	5 cards
ClearMultiprint Markers		1492-MT5X8 (800/	1 roll

(1) Available in orange as standard, to order other colors add the appropriate suffix to the catalog number listed: Blue =B, Red = RE. Example for a red 2-pole center jumper, the catalog number will be 1492-CJP3-2-RE.

Wiring Diagram

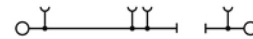

IMPORTANT See [page 69](#) for ferrule selection.

1492-P3PT

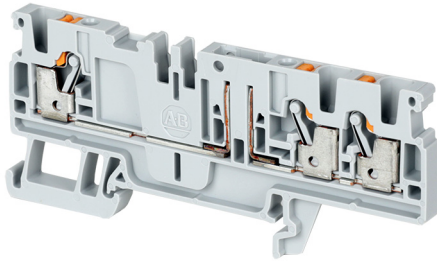

Terminal Blocks—Dimensions (W x H x L): 5.1 x 36.5 x 84.5mm		
Color	Cat. No.	Pkg. Qty.
Grey	1492-P3PT	50

Specifications — Accessory Plug-in Terminal Block		
Certifications	/CSA	IEC
Voltage Rating	300V AC/DC	500V AC/DC
Maximum Current	20 A	20 A
Wire Range (Rated Cross Section)	28...12 AWG	2.5 mm ²
Wire Strip Length	0.4 in. (10 mm)	
Density	59 pcs/ft (196 pcs/m)	
Housing Temperature Range	-76...266°F (-60...130 °C)	

Accessories		Cat. No.	Pkg Qty.
Mounting Rails, End Barriers, End Anchors and Retainers			
Mounting Rail 1 m Symmetrical DIN	Steel	199-DR1	10
	Aluminum	1492-DR5	10
	Hi-Rise (Aluminum)	1492-DR6	2
	Angled (Steel)	1492-DR7	2
End Barriers	Grey	1492-EBPKD3T	50
	Blue	1492-EBPKD3T-B	50
End Retainer		1492-ERL35	20
End Anchor DIN Rail	Normal Duty	1492-EAJ35	100
	Heavy Duty	1492-EAHJ35	50
	Normal Duty	1492-EAP35	50

Accessories	Cat. No.	Pkg Qty.
Center Jumpers⁽¹⁾		
2-pole	1492-CJP3-2	60
3-pole	1492-CJP3-3	20
4-pole	1492-CJP3-4	
5-pole	1492-CJP3-5	
6-pole	1492-CJP3-6	
7-pole	1492-CJP3-7	
8-pole	1492-CJP3-8	
9-pole	1492-CJP3-9	
10-pole	1492-CJP3-10	
20-pole	1492-CJP3-20	
50-pole	1492-CJP3-50	

Disconnect, Component, and Fuse Plugs			
Disconnect Plug	1492-DPL	50	
Component Plug	1492-CPL	50	
Fuse Plugs	Without blown fuse indicator	1492-FPK2	20
	10...36V blown fuse indicator	1492-FPK224	20
	35...75V blown fuse indicator	1492-FPK248	20
	60...150V blown fuse indicator	1492-FPK2120	20
	140...250V blown fuse indicator	1492-FPK2250	20

Test Plugs			
Test Plugs	Start Test Plug	1492-PTPS	50
	Test Plug	1492-P3TPE	50

Marking Systems		
ClearPlot Basic Marker Cards	1492-MR5X8 (120/card)	5 cards
ClearMultiprint Markers	1492-MT5X8 (800/roll)	1 roll

(1) Available in orange as standard, to order other colors add the appropriate suffix to the catalog number listed: Blue =B, Red = RE. Example for a red 2-pole center jumper, the catalog number will be 1492-CJP3-2-RE.

Wiring Diagram

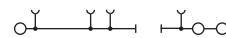

IMPORTANT See [page 69](#) for ferrule selection.

1492-P3PQ

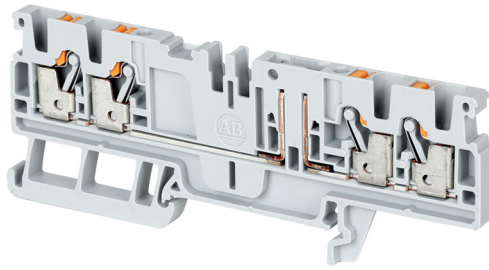

Terminal Blocks—Dimensions (W x H x L): 5.1 x 36.5 x 96mm		
Color	Cat. No.	Pkg. Qty.
 Grey	1492-P3PQ	50

Specifications — Accessory Plug-in Terminal Block		
Certifications	 /CSA	IEC
Voltage Rating	300V AC/DC	500V AC/DC
Maximum Current	20 A	20 A
Wire Range (Rated Cross Section)	28...12 AWG	2.5 mm ²
Wire Strip Length	0.4 in. (10 mm)	
Density	59 pcs/ft (196 pcs/m)	
Housing Temperature Range	-76...266°F (-60...130 °C)	

Accessories		Cat. No.	Pkg Qty.
Mounting Rails, End Barriers, End Anchors and Retainers			
Mounting Rail 1 m Symmetrical DIN	Steel	199-DR1	10
	Aluminum	1492-DR5	10
	Hi-Rise (Aluminum)	1492-DR6	2
	Angled (Steel)	1492-DR7	2
End Retainer		1492-ERL35	20
End Barriers	Grey	1492-EBPKD3Q	50
	Blue	1492-EBPKD3Q-B	50
End Anchor DIN Rail	Normal Duty	1492-EAJ35	100
	Heavy Duty	1492-EAHJ35	50
	Normal Duty	1492-EAP35	50

Accessories		Cat. No.	Pkg Qty.
Center Jumpers⁽¹⁾			
2-pole	Orange	1492-CJP3-2	60
3-pole		1492-CJP3-3	20
4-pole		1492-CJP3-4	
5-pole		1492-CJP3-5	
6-pole		1492-CJP3-6	
7-pole		1492-CJP3-7	
8-pole		1492-CJP3-8	
9-pole		1492-CJP3-9	
10-pole		1492-CJP3-10	
20-pole		1492-CJP3-20	
50-pole	1492-CJP3-50		

Disconnect, Component, and Fuse Plugs			
Disconnect Plug	1492-DPL	50	
Component Plug	1492-CPL	50	
Fuse Plugs	Without blown fuse indicator	1492-FPK2	20
	10...36V blown fuse indicator	1492-FPK224	20
	35...75V blown fuse indicator	1492-FPK248	20
	60...150V blown fuse indicator	1492-FPK2120	20
	140...250V blown fuse indicator	1492-FPK2250	20

Test Plugs			
Test Plugs	Start Test Plug	1492-PTPS	50
	Test Plug	1492-P3TPE	50

Marking Systems		
ClearPlot Basic Marker Cards	1492-MR5X8 (120/card)	5 cards
ClearMultiprint Markers	1492-MT5X8 (800/roll)	1 roll

(1) Available in orange as standard, to order other colors add the appropriate suffix to the catalog number listed: Blue =B, Red = RE. Example for a red 2-pole center jumper, the catalog number will be 1492-CJP3-2-RE.

Wiring Diagram



IMPORTANT See [page 69](#) for ferrule selection.

Fuse Terminal Blocks



Terminal Blocks—Dimensions (W x H x L): 6.1 x 69 x 74 mm			
Color	Includes LED for Blown Fuse Indication	Cat. No.	Pkg. Qty.
■ Black	No	1492-PFB4	50
	Yes	1492-PFB424	
		1492-PFB448	
		1492-PFB4120	
		1492-PFB4250	

Specifications — Single-level Feed-through Terminal Block				
Certifications		UL /CSA	IEC	ATEX
Voltage Rating	1492-PFB4	300V AC/DC	250V AC/DC	250V AC/DC
	1492-PFB424	10...36V AC/DC		
	1492-PFB448	30...70V AC/DC		
	1492-PFB4120	60...150V AC/DC		
	1492-PFB4250	100...250V AC/DC		
Maximum Current	10 A	6.3 A	6.3 A	
Wire Range (Rated Cross Section)	26...10 AWG	4 mm ²	4 mm ²	
Wire Strip Length	0.47 in. (12 mm)			
Density	49 pcs/ft (163 pcs/m)			
Housing Temperature Range	-76...266°F (-60...130 °C)			

Accessories	Cat. No.	Pkg Qty.	
Mounting Rails, End Barriers, End Anchors and Retainers			
Mounting Rail 1 m Symmetrical DIN	Steel	199-DR1	10
	Aluminum	1492-DR5	10
	Hi-Rise (Aluminum)	1492-DR6	2
	Angled (Steel)	1492-DR7	2
End Barriers	Grey	1492-EBP4T	20
	Blue	1492-EBP4T-B	20
	Yellow	1492-EBP4T-Y	50
End Retainer	1492-ERL35	20	

Accessories	Cat. No.	Pkg Qty.	
End Anchor DIN Rail	Normal Duty	1492-EAJ35	100
	Heavy Duty	1492-EAHJ35	50
	Normal Duty	1492-EAP35	50

Center Jumpers ⁽¹⁾			
2-pole	Orange	1492-CJP4-2	60
3-pole		1492-CJP4-3	20
4-pole		1492-CJP4-4	
5-pole		1492-CJP4-5	
6-pole		1492-CJP4-6	
7-pole		1492-CJP4-7	
8-pole		1492-CJP4-8	
9-pole		1492-CJP4-9	
10-pole		1492-CJP4-10	
50-pole		1492-CJP4-50	

Test Plugs			
Test Plugs	Start Test Plug	1492-PTPS	50
	Test Plug	1492-P4TPE	50

Marking Systems			
ClearPlot Basic Marker Cards	1492-MR6X8 (120/card)	5 cards	
ClearMultiprint Markers	1492-MT6X8 (600/roll)	1 roll	

(1) Available in orange as standard, to order other colors add the appropriate suffix to the catalog number listed: Blue =B, Red =RE. Example for a red 2-pole center jumper, the catalog number will be 1492-CJP4-2-RE.

Wiring Diagram

No Blown Fuse Indication

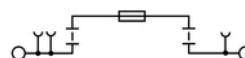

With Blown Fuse Indication

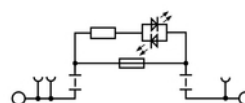

IMPORTANT See [page 70](#) for ferrule selection.

Ferrule Selection

Panduit Ferrules and Tools for use with 1492-P2 Terminal Blocks

Uninsulated Ferrule



Wire Size (AWG)	Loose Piece Ferrules for use with Hand Crimp Tools	Hand Crimp Tools for Loose Piece Ferrules ⁽¹⁾					
		1	2	3	4	5	6
24	F73-5-M	●			●		
24-22	F74-5-M	●			●		
22-20	F75-6-M	●	●	●	●	●	●
18	F76-6-M	●	●	●	●	●	●
16	F78-7-M	●	●	●	●	●	●
14	F80-7-M			●	●	●	●

Insulated Ferrule









Wire Size (AWG)	Ferrule Insulation Color	Continuous Reeled Ferrules for use with CP-881 Automated Crimp Tool	Loose Piece Ferrules for use with Hand Crimp Tools	Hand Crimp Tools for Loose Piece Ferrules ⁽¹⁾					
				1	2	3	4	5	6
26	Grey	—	FSD72-6-D	●			●		
24	Yellow	—	FSD73-6-D	●			●		
24-22	Turquoise	—	FSD74-6-D	●			●		
22-20	White	FSD75-8-K	FSD75-6-D	●	●	●	●	●	●
18	Grey	FSD76-8-K	FSD76-6-D	●	●	●	●	●	●
16	Black	FSD78-8-K	FSD78-6-D			●	●	●	●
14	Blue	—	FSD80-12-D			●	●	●	●

Twin Insulated Ferrule



Wire Size (AWG)	Ferrule Insulation Color	Loose Piece Ferrules for use with Hand Crimp Tools	Hand Crimp Tools for Loose Piece Ferrules ⁽¹⁾					
			1	2	3	4	5	6
16	Black	FTD78-12-D	●		●	●		

(1) Hand Crimp Tool Reference

Reference Number	1	2	3	4	5	6
Hand Crimp Tool Part No.	CT-1002	CT-1003	CT-1090	CT-1123	CT-1160	CT-1170
Crimp Shape	Trapezoid	Trapezoid	Trapezoid	Square	Hexagon	Square
Shape Reference						

IMPORTANT For more information on Panduit ferrules and tools, visit panduit.com.

Panduit Ferrules and Tools for use with 1492-P3 Terminal Blocks

Uninsulated Ferrule



Wire Size (AWG)	Loose Piece Ferrules for use with Hand Crimp Tools	Hand Crimp Tools for Loose Piece Ferrules ⁽¹⁾					
		1	2	3	4	5	6
24	F73-5-M	●			●		
24-22	F74-5-M	●			●		
22-20	F75-6-M	●	●	●	●	●	●
18	F76-6-M	●	●	●	●	●	●
16	F78-7-M	●	●	●	●	●	●
14	F80-7-M			●	●	●	●
12	F81-9-M			●			●

Insulated Ferrule



Wire Size (AWG)	Ferrule Insulation Color	Continuous Reeled Ferrules for use with CP-881 Automated Crimp Tool	Loose Piece Ferrules for use with Hand Crimp Tools	Hand Crimp Tools for Loose Piece Ferrules ⁽¹⁾					
				1	2	3	4	5	6
26	Grey	—	FSD72-6-D	●			●		
24	Yellow	—	FSD73-6-D	●			●		
24-22	Turquoise	—	FSD74-6-D	●			●		
22-20	White	FSD75-8-K	FSD75-6-D	●	●	●	●	●	●
18	Grey	FSD76-8-K	FSD76-6-D	●	●	●	●	●	●
16	Black	FSD78-8-K	FSD78-6-D			●	●	●	●
14	Blue	FSD80-8-DK	FSD80-12-D			●	●	●	●
12	Grey	—	FSD81-10-D			●	●	●	●

Twin Insulated Ferrule



Wire Size (AWG)	Ferrule Insulation Color	Loose Piece Ferrules for use with Hand Crimp Tools	Hand Crimp Tools for Loose Piece Ferrules ⁽¹⁾					
			1	2	3	4	5	6
22	White	FTD75-8-D	●	●	●	●	●	●
20	Grey	FTD76-8-D	●	●	●	●	●	●
18	Red	FTD77-8-D	●	●	●	●	●	●

(1) Hand Crimp Tool Reference

Reference Number	1	2	3	4	5	6
Hand Crimp Tool Part No.	CT-1002	CT-1003	CT-1090	CT-1123	CT-1160	CT-1170
Crimp Shape	Trapezoid	Trapezoid	Trapezoid	Square	Hexagon	Square
Shape Reference						

IMPORTANT For more information on Panduit ferrules and tools, visit panduit.com.

Panduit Ferrules and Tools for use with 1492-P4 Terminal Blocks

Uninsulated Ferrule



Wire Size (AWG)	Loose Piece Ferrules for use with Hand Crimp Tools	Hand Crimp Tools for Loose Piece Ferrules ⁽¹⁾					
		1	2	3	4	5	6
24	F73-5-M	●			●		
24-22	F74-5-M	●			●		
22-20	F75-6-M	●	●	●	●	●	●
18	F76-6-M	●	●	●	●	●	●
16	F78-7-M	●	●	●	●	●	●
14	F80-7-M			●	●	●	●
12	F81-9-M			●	●	●	●
10	F82-12-M			●	●	●	●

Insulated Ferrule



Wire Size (AWG)	Ferrule Insulation Color	Continuous Reeled Ferrules for use with CP-881 Automated Crimp Tool	Loose Piece Ferrules for use with Hand Crimp Tools	Hand Crimp Tools for Loose Piece Ferrules ⁽¹⁾					
				1	2	3	4	5	6
26	Grey	—	FSD72-6-D	●			●		
24	Yellow	—	FSD73-6-D	●			●		
24-22	Turquoise	—	FSD74-6-D	●			●		
22-20	White	FSD75-8-K	FSD75-6-D	●	●	●	●	●	●
18	Grey	FSD76-8-K	FSD76-6-D	●	●	●	●	●	●
16	Black	FSD78-8-K	FSD78-6-D			●	●	●	●
14	Blue	FSD80-8-DK	FSD80-12-D			●	●	●	●
12	Grey	—	FSD81-10-D			●	●	●	●
10	Yellow	—	FSD82-12-C			●	●	●	●

Twin Insulated Ferrule



Wire Size (AWG)	Ferrule Insulation Color	Loose Piece Ferrules for use with Hand Crimp Tools	Hand Crimp Tools for Loose Piece Ferrules ⁽¹⁾					
			1	2	3	4	5	6
22	White	FTD75-8-D	●	●	●	●	●	●
20	Grey	FTD76-8-D	●	●	●	●	●	●
18	Red	FTD77-8-D	●	●	●	●	●	●

(1) Hand Crimp Tool Reference

Reference Number	1	2	3	4	5	6
Hand Crimp Tool Part No.	CT-1002	CT-1003	CT-1090	CT-1123	CT-1160	CT-1170
Crimp Shape	Trapezoid	Trapezoid	Trapezoid	Square	Hexagon	Square
Shape Reference						

IMPORTANT For more information on Panduit ferrules and tools, visit panduit.com.

Panduit Ferrules and Tools for use with 1492-P6 Terminal Blocks

Uninsulated Ferrule



Wire Size (AWG)	Loose Piece Ferrules for use with Hand Crimp Tools	Hand Crimp Tools for Loose Piece Ferrules ⁽¹⁾					
		1	2	3	4	5	6
22-20	F75-6-M	●	●	●	●	●	●
18	F76-6-M	●	●	●	●	●	●
16	F78-7-M	●	●	●	●	●	●
14	F80-7-M			●	●	●	●
12	F81-9-M			●	●	●	●
10	F82-12-M			●	●	●	●
8	F83-12-D			●	●	●	●

Insulated Ferrule



Wire Size (AWG)	Ferrule Insulation Color	Continuous Reeled Ferrules for use with CP-881 Automated Crimp Tool	Loose Piece Ferrules for use with Hand Crimp Tools	Hand Crimp Tools for Loose Piece Ferrules ⁽¹⁾					
				1	2	3	4	5	6
22-20	White	FSD75-8-K	FSD75-6-D	●	●	●	●	●	●
18	Grey	FSD76-8-K	FSD76-6-D	●	●	●	●	●	●
16	Black	FSD78-8-K	FSD78-6-D			●	●	●	●
14	Blue	FSD80-8-DK	FSD80-12-D			●	●	●	●
12	Grey	—	FSD81-10-D			●	●	●	●
10	Yellow	—	FSD82-12-C			●	●	●	●

Twin Insulated Ferrule



Wire Size (AWG)	Ferrule Insulation Color	Loose Piece Ferrules for use with Hand Crimp Tools	Hand Crimp Tools for Loose Piece Ferrules ⁽¹⁾					
			1	2	3	4	5	6
22	White	FTD75-8-D	●	●	●	●	●	●
20	Grey	FTD76-8-D	●	●	●	●	●	●
18	Red	FTD77-8-D	●	●	●	●	●	●
16	Black	FTD78-8-D	●	●	●	●	●	●

(1) Hand Crimp Tool Reference

Reference Number	1	2	3	4	5	6
Hand Crimp Tool Part No.	CT-1002	CT-1003	CT-1090	CT-1123	CT-1160	CT-1170
Crimp Shape	Trapezoid	Trapezoid	Trapezoid	Square	Hexagon	Square
Shape Reference						

IMPORTANT For more information on Panduit ferrules and tools, visit panduit.com.

Panduit Ferrules and Tools for use with 1492-P10 Terminal Blocks

Uninsulated Ferrule



Wire Size (AWG)	Loose Piece Ferrules for use with Hand Crimp Tools	Hand Crimp Tools for Loose Piece Ferrules ⁽¹⁾						
		1	2	3	4	5	6	7
22-20	F75-6-M	●	●	●	●	●	●	
18	F76-6-M	●	●	●	●	●	●	
16	F78-7-M	●	●	●	●	●	●	
14	F80-7-M			●	●	●	●	
12	F81-9-M			●	●	●	●	
10	F82-10-M			●	●	●	●	
8	F83-12-D			●	●			●
6	F84-12-TL							●

Insulated Ferrule



Wire Size (AWG)	Ferrule Insulation Color	Continuous Reeled Ferrules for use with CP-881 Automated Crimp Tool	Loose Piece Ferrules for use with Hand Crimp Tools	Hand Crimp Tools for Loose Piece Ferrules ⁽¹⁾						
				1	2	3	4	5	6	7
22-20	White	FSD75-8-K	FSD75-6-D	●	●	●	●	●	●	
18	Grey	FSD76-8-K	FSD76-6-D	●	●	●	●	●	●	
16	Black	FSD78-8-K	FSD78-6-D			●	●	●	●	
14	Blue	—	FSD80-12-D			●	●	●	●	
12	Grey	—	FSD81-10-D			●	●	●	●	
10	Yellow	—	FSD82-12-C			●	●	●	●	
8	Red	—	FSD83-12-C			●	●			●
6	Blue	—	FSD84-12-C							●

Twin Insulated Ferrule



Wire Size (AWG)	Ferrule Insulation Color	Loose Piece Ferrules for use with Hand Crimp Tools	Hand Crimp Tools for Loose Piece Ferrules ⁽¹⁾					
			1	2	3	4	5	6
22	White	FTD75-8-D	●	●	●	●	●	●
20	Grey	FTD76-8-D	●	●	●	●	●	●
18	Red	FTD77-8-D	●	●	●	●	●	●
16	Black	FTD78-8-D	●	●	●	●	●	●
14	Blue	FTD80-10-TL	●	●	●	●	●	●
12	Grey	FTD81-12-C	●	●	●	●	●	●

(1) Hand Crimp Tool Reference

Reference Number	1	2	3	4	5	6	7
Hand Crimp Tool Part No.	CT-1002	CT-1003	CT-1090	CT-1123	CT-1160	CT-1170	CT-1004
Crimp Shape	Trapezoid	Trapezoid	Trapezoid	Square	Hexagon	Square	Trapezoid
Shape Reference							

IMPORTANT For more information on Panduit ferrules and tools, visit panduit.com.

Additional Resources

These documents contain additional information concerning related products from Rockwell Automation.

Resource	Description
Push-in Terminal Blocks Product Profile, publication 1492-PP014	Provides features and benefits, offering and basic specifications.
Industrial Automation Wiring and Grounding Guidelines, publication 1770-4.1	Provides general guidelines for installing a Rockwell Automation industrial system.
Product Certifications website, rok.auto/certifications .	Provides declarations of conformity, certificates, and other certification details.

You can view or download publications at <http://www.rockwellautomation.com/global/literature-library/overview.page>.

Rockwell Automation Support

Use the following resources to access support information.

Technical Support Center	Knowledgebase Articles, How-to Videos, FAQs, Chat, User Forums, and Product Notification Updates.	www.rockwellautomation.com/knowledgebase
Local Technical Support Phone Numbers	Locate the phone number for your country.	www.rockwellautomation.com/global/support/get-support-now.page
Direct Dial Codes	Find the Direct Dial Code for your product. Use the code to route your call directly to a technical support engineer.	www.rockwellautomation.com/global/support/direct-dial.page
Literature Library	Installation Instructions, Manuals, Brochures, and Technical Data.	www.rockwellautomation.com/literature
Product Compatibility and Download Center (PCDC)	Get help determining how products interact, check features and capabilities, and find associated firmware.	www.rockwellautomation.com/global/support/pcdc.page

Documentation Feedback

Your comments will help us serve your documentation needs better. If you have any suggestions on how to improve this document, complete the How Are We Doing? form at http://literature.rockwellautomation.com/idc/groups/literature/documents/du/ra-du002_-en-e.pdf.

Rockwell Automation Support

For technical support, visit <http://www.rockwellautomation.com/support/overview.page>.

Rockwell Automation maintains current product environmental information on its website at <http://www.rockwellautomation.com/rockwellautomation/about-us/sustainability-ethics/product-environmental-compliance.page>.

Allen-Bradley, ClearMultiPrint, ClearPlot, LISTEN. THINK. SOLVE., Rockwell Automation, and Rockwell Software are trademarks of Rockwell Automation, Inc. Trademarks not belonging to Rockwell Automation are property of their respective companies.

Rockwell Otomasyon Ticaret A.Ş., Kar Plaza İş Merkezi E Blok Kat:6 34752 İçerenköy, İstanbul, Tel: +90 (216) 5698400

www.rockwellautomation.com

Power, Control and Information Solutions Headquarters

Americas: Rockwell Automation, 1201 South Second Street, Milwaukee, WI 53204-2496 USA, Tel: (1) 414.382.2000, Fax: (1) 414.382.4444
Europe/Middle East/Africa: Rockwell Automation NV, Pegasus Park, De Kleetlaan 12a, 1831 Diegem, Belgium, Tel: (32) 2 663 0600, Fax: (32) 2 663 0640
Asia Pacific: Rockwell Automation, Level 14, Core F, Cyberport 3, 100 Cyberport Road, Hong Kong, Tel: (852) 2887 4788, Fax: (852) 2508 1846

Publication 1492-TD017B-EN-P - October 2018

Supersedes Publication 1492-TD017A-EN-P - April 2018

Copyright © 2018 Rockwell Automation, Inc. All rights reserved. Printed in the U.S.A.