

# Bulletin 1609 Uninterruptible Power Supply

Catalog Numbers 1609-D and 1609-B



## Important User Information

Solid-state equipment has operational characteristics differing from those of electromechanical equipment. Safety Guidelines for the Application, Installation and Maintenance of Solid State Controls (publication [SGI-1.1](#) available from your local Rockwell Automation® sales office or online at <http://www.rockwellautomation.com/literature/>) describes some important differences between solid-state equipment and hard-wired electromechanical devices. Because of this difference, and also because of the wide variety of uses for solid-state equipment, all persons responsible for applying this equipment must satisfy themselves that each intended application of this equipment is acceptable.

In no event will Rockwell Automation, Inc. be responsible or liable for indirect or consequential damages resulting from the use or application of this equipment.

The examples and Figures in this manual are included solely for illustrative purposes. Because of the many variables and requirements associated with any particular installation, Rockwell Automation, Inc. cannot assume responsibility or liability for actual use based on the examples and Figures.

No patent liability is assumed by Rockwell Automation, Inc. with respect to use of information, circuits, equipment, or software described in this manual.

Reproduction of the contents of this manual, in whole or in part, without written permission of Rockwell Automation, Inc., is prohibited.

Throughout this manual, when necessary, we use notes to make you aware of safety considerations.



**WARNING:** Identifies information about practices or circumstances that can cause an explosion in a hazardous environment, which may lead to personal injury or death, property damage, or economic loss.



**ATTENTION:** Identifies information about practices or circumstances that can lead to personal injury or death, property damage, or economic loss. Attentions help you identify a hazard, avoid a hazard, and recognize the consequence.



**SHOCK HAZARD:** Labels may be on or inside the equipment, for example, a drive or motor, to alert people that dangerous voltage may be present.



**BURN HAZARD:** Labels may be on or inside the equipment, for example, a drive or motor, to alert people that surfaces may reach dangerous temperatures.

---

### IMPORTANT

Identifies information that is critical for successful application and understanding of the product.

---

Allen-Bradley, Rockwell Software, Rockwell Automation, and TechConnect are trademarks of Rockwell Automation, Inc.

Trademarks not belonging to Rockwell Automation are property of their respective companies.



**WARNING:** This is a category C2 UPS product. In a residential environment, this product may cause radio interference, in which case the user may be required to take additional measures.

---

## Additional Resources

These documents contain additional information concerning related products from Rockwell Automation

Resource	Description
Industrial Automation Wiring and Grounding Guidelines, publication <a href="#">1770-4.1</a>	Provides general guidelines for installing a Rockwell Automation industrial system.
Product Certifications website, <a href="http://www.ab.com">http://www.ab.com</a>	Provides declarations of conformity, certificates, and other certification details.
Publication Number: <a href="#">1609-UM007 -EN-P</a>	Bulletin 1609 UPS Management Software User Manual
Publication Number: <a href="#">1609-UM008 -EN-P</a>	Network Management Card - Cat. No. 1609-ENET User Manual
Publication Number: <a href="#">1609-IN012 -EN-P</a>	Bulletin 1609-D Installation Instructions
Publication Number: <a href="#">1609-IN013 -EN-P</a>	Bulletin 1609-B Installation Instructions
Publication Number: <a href="#">1609-IN014 -EN-P</a>	Surge Protective Device (Cat. No. 1609-SPD) Installation Instructions
Publication Number: <a href="#">1609-IN015 -EN-P</a>	Network Management Card (Cat. No. 1609-ENET) Installation Instructions

You can view or download publications at <http://www.rockwellautomation.com/literature/>. To order paper copies of technical documentation, contact your local Allen-Bradley distributor or Rockwell Automation sales representative.

**Notes:**

<b>Bul. 1609-D Installation Instructions</b>	Battery Wiring and Installation .....	7
	Mount the UPS .....	8
	Hardwire UPS .....	9
	Selection of Cables .....	9
	Connect Power and Equipment to the UPS .....	10
	Bul. 1609-D Block Figure .....	10
<b>Bul. 1609-B Installation Instructions</b>	Battery Wiring and Installation .....	11
	Mount the UPS .....	13
	Hardwire UPS .....	13
	Selection of Cables .....	13
	Connect Power and Equipment to the UPS .....	14
	1609-B Block Figure .....	14
<b>Bul. 1609-EXBAT Installation Instructions</b>	Battery Wiring and Installation .....	15
	Mount the 1609-EXBAT.....	17
	Selection of Cables .....	18
	Connect the 1609-EXBAT to the UPS .....	18
<b>General Information 1609-D and 1609-B</b>	Recommended Battery for use with the UPS .....	19
	Dry I/O Contacts .....	19
	USB Communication Port .....	19
	Manual or Remote Enable/Disable of UPS Output Selection .....	20
	Manual Enable/Disable/Self-test .....	20
	Remote Enable/Disable.....	20
	Display LED Indicators.....	21
<b>Troubleshooting</b>	UPS LED Fault Indicators.....	23
	Output Short Circuit .....	23
	Output Overload .....	23
	Over Temperature from the Heatsink .....	23
	Over Ambient Temperature .....	23
	Over Voltage from The DC/DC Converter of Inverter .....	23
	Over Voltage from The Inverter .....	23
	Under Voltage from The Inverter .....	23
	Over Voltage from the Output .....	24
	Under Voltage from the Output.....	24
	Fan Failure .....	24
	Charger Failure .....	24
	TMOV Failure .....	24
Missing Battery .....	24	
Replace Batteries .....	24	

<b>Troubleshooting (continued)</b>	UPS Management Software Troubleshooting.....25
	UPS Network Management Card Troubleshooting .....26
<b>Specifications</b>	Bul. 1609-D 120 V Specifications .....27
	Bul. 1609-D 230V Specifications .....28
	Bul. 1609-B 120V Specifications .....29
	Bul. 1609-B 230V Specifications .....30
<b>Dimensions</b>	Bul. 1609-D Dimensions.....31
	Bul. 1609-B Dimensions .....31
	Bul. 1609-EXBAT Dimensions.....31
	Bul. 1609-BRK Dimensions.....32
<b>Service Instructions</b>	Service Instructions.....32

# Bulletin 1609-D Installation Instructions



**ATTENTION:** Do not service the 1609-SPD without disconnecting the power sources due to electric shock hazard for risk of severe injury or death.

## Battery Wiring and Installation

Note: Batteries are not included with the 1609-D UPS

1. To access the battery compartment remove the three screws and the battery door.



2. Remove the battery container, jumpers, and wire harness from the battery compartment. Place the battery container and batteries onto a flat surface. Use the provided jumper wires to connect the batteries in series. Connect the positive terminal (red) of the battery to the negative terminal (black) of another battery. See photo below for details.

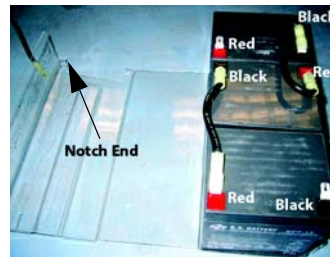

3. Connect the red wire of the harness to the positive terminal (top red) and the black wire of the harness to the negative terminal (bottom black). See photo below for details.

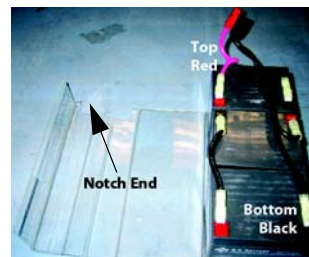

## Battery Wiring and Installation (cont.)

4. Fold the battery container and seal it with tape.

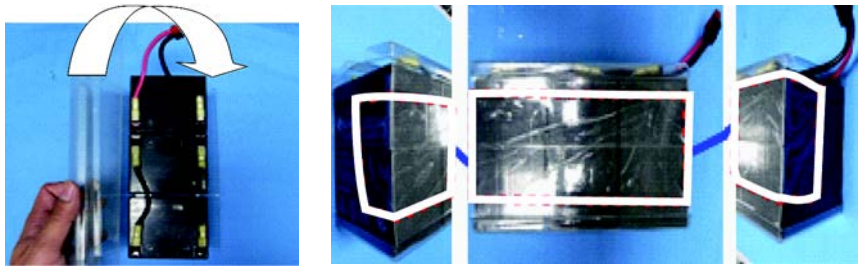

5. To connect the batteries to the UPS, insert the batteries into the battery compartment, open the white connector retainer and connect the two cables together as shown in the photo below.



6. To complete the battery installation, close the white connector retainer and reattach the battery door with the three screws (torque of 8.7+/-1.7 lb-in).



## Mount the UPS

The UPS-D is designed to mount on the back of the panel or to the floor of the enclosure. The UPS mounts to a bracket assembly (1609-BRK) that allows it to mount to either the panel or floor (see Figure 1 below).

**Figure 1 - Mounting the UPS**

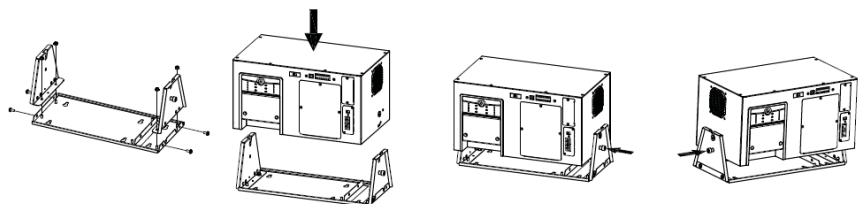



## Hardwire UPS

Wiring of the UPS should be performed by a qualified electrician using the appropriate wire gauges.

## Selection of Cables

**Table 1 - AC Main Input/Output Wiring for UPS:**

Item	Specification
Wire Size	14 AWG
Minimum temperature	75 °C
Wire conductor material	Copper only
Tightening torque for terminals	4.4 lb-in.

**Table 2 - DC Input / Output Wiring for External Battery Cabinet:**

Item	Specification
Wire Size	10 AWG
Minimum temperature	75 °C
Wire conductor material	Copper only
Tightening torque for terminals	12 lb-in.



**WARNING:** To reduce the risk of fire, connect only to a circuit with 20 amperes maximum branch circuit overcurrent protection in accordance with the National Electric Code, ANSI/NFPA 70.

A disconnect switch shall be provided by others for AC output circuit.  
To reduce the risk of fire, connect only to a circuit with branch circuit overcurrent protection for 20 amperes rating in accordance with the National Electric Code, ANSI/NFPA 70.

## Connect Power and Equipment to the UPS



**WARNING:** This UPS features Surge Protection Device (SPD) is located on the left front of the unit. Disconnect all power sources before servicing due to Electric Shock Hazard for risk of severe injury or death.

1. Connect the appropriate input power to the UPS's input (Line, Neutral and Ground) terminals (see Figure 2).
2. Connect the specified equipment to the UPS's output (Line, Neutral and Ground) terminals (see Figure 2).

**Figure 2 - System Wiring**

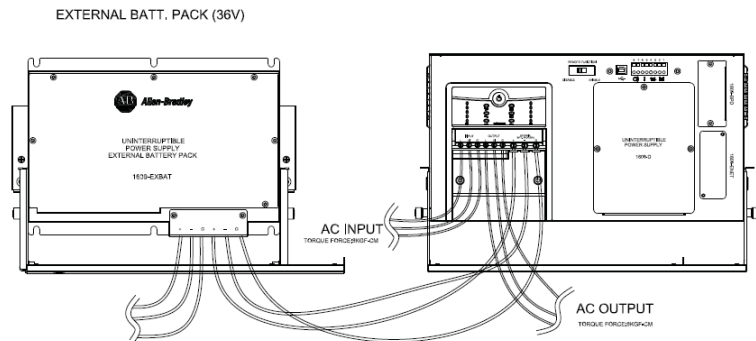

3. Connect any additional optional accessories (1609-ENET card).

## 1609-D Block Figure

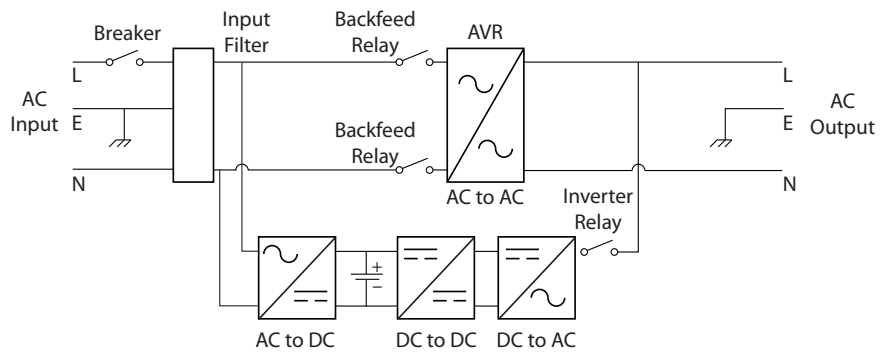

## 1609-B Installation Instructions



**ATTENTION:** Disconnect the 1609-SPD before servicing, due to electric shock hazard for risk of severe injury or death.

### Battery Wiring and Installation

Note: Batteries are not included with the 1609-B UPS

1. To access the battery compartment remove the three screws and the battery door.



2. Remove the battery container, jumpers, and wire harness from the battery compartment. Place the battery container and batteries onto a flat surface. Use the provided jumper wires to connect the batteries in series. Connect the positive terminal (red) of the battery to the negative terminal (black) of another battery. Connect the red wire of the harness to the positive terminal (top red) and the black wire of the harness to the negative terminal (bottom black). See photo below for details.

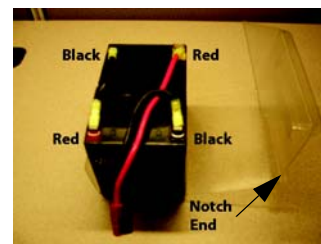

3. Fold the battery container and seal it with tape.

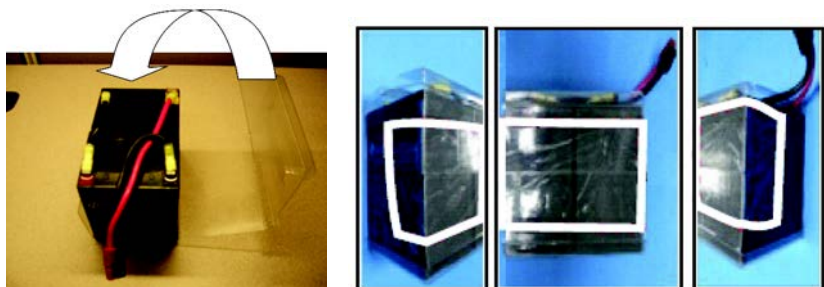

## Battery Wiring and Installation (cont.)

4. To connect the batteries to the UPS, insert the batteries into the battery compartment, open the white connector retainer and connect the two cables together as shown in the photo below.



5. To complete the battery installation, close the white connector retainer and reattach the battery door with the three screws (torque of 8.7+/-1.7 lb-in).

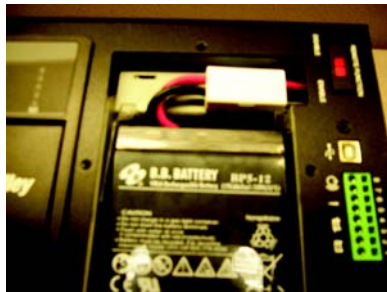

## Mount the UPS

The 1609-B UPS products are designed to mount to a heavy duty DIN-rail (see Figure 3 below). The 1609-B UPS products are also designed with an optional bracket assembly (Cat 1609-BRK) that allows it to mount to either the panel or floor (see Figure 4 below).

**Figure 3 - Standard DIN-Rail Mount**

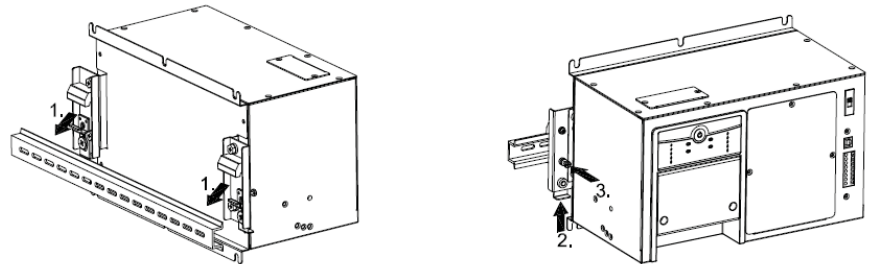

**Figure 4 - Optional Panel or Floor Mount**

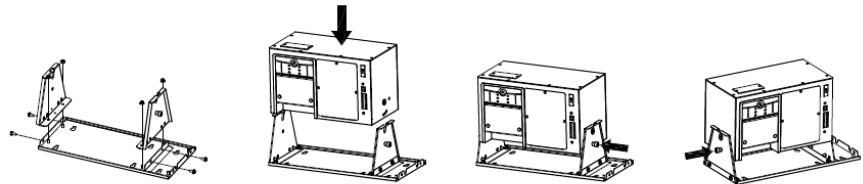

## Hardwire UPS

Wiring of the UPS should be performed by a qualified electrician using the appropriate wire gauges.

## Selection of Cables

**Table 3 - AC Main Input / Output Wiring for UPS**

Item	Specification
Wire Size	14 AWG
Minimum Temperature	75 °C
Wire Conductor Material	Copper only
Tightening Torque for Terminals	4.4 lb - in.



**WARNING:** To reduce the risk of fire, connect only to a circuit with 20 amperes maximum branch circuit overcurrent protection in accordance with the National Electric Code, ANSI/NFPA 70.

A disconnect switch shall be provided by others for AC output circuit. To reduce the risk of fire, connect only to a circuit with branch circuit overcurrent protection for 20 amperes rating in accordance with the National Electric Code, ANSI/NFPA 70.

## Connect Power and Equipment to the UPS



**WARNING:** This UPS features Surge Protective Device (SPD) located on the top of the unit. Please disconnect all power sources before servicing due to Electric Shock Hazard for risk of severe injury or death.

1. Connect the appropriate input power to the UPS's input (Line, Neutral and Ground) terminals (see Figure 5).
2. Connect the specified equipment to the UPS's output (Line, Neutral and Ground) terminals (see Figure 5).

Figure 5 - System Wiring

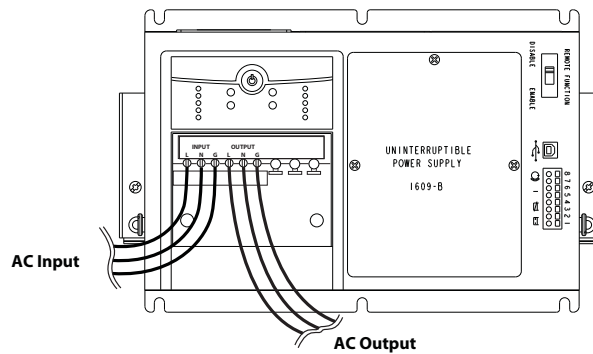

## 1609-B Block Figure

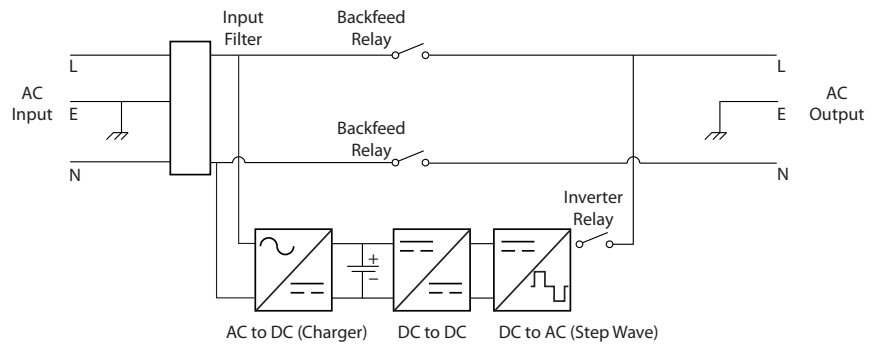

# 1609-EXBAT Installation Instructions

## Battery Wiring and Installation

Only use battery wires that have been provided with the 1609-EXBAT.



**WARNING:** A disconnect switch shall be provided by others for DC output circuit. To reduce the risk of fire, connect only to a circuit with branch circuit overcurrent protection for 35 amperes rating in accordance with the National Electric Code, ANSI/NFPA 70.

Before connecting a battery pack to UPS, the emergent disconnecting device shall be provided between the UPS and battery pack.

1. To access the battery compartment remove the six screws and the battery door.



2. Remove the battery container, jumpers and wire harness from the battery compartment. Place the battery container and batteries onto a flat surface. Use the provided jumper wires to connect the batteries in series. Connect the positive terminal (red) of the battery to the negative terminal (black) of another battery. See photo below for details.

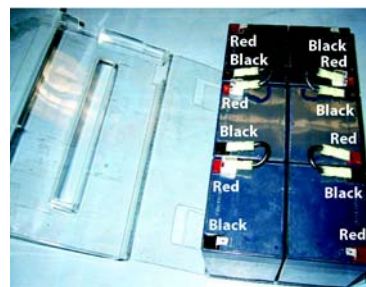

## Battery Wiring and Installation (cont.)

3. Connect the shorter set of red and black wires of the harness to the top terminals (red - to - red and black - to - black). Connect the longer set of red and black wires of the harness to the bottom terminals (red - to - red and black - to - black) and route the wires through the cut-out hole. See photo below for details.

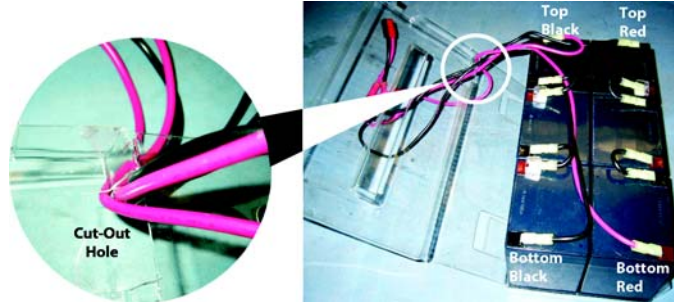

4. Fold the battery container and seal it with tape.

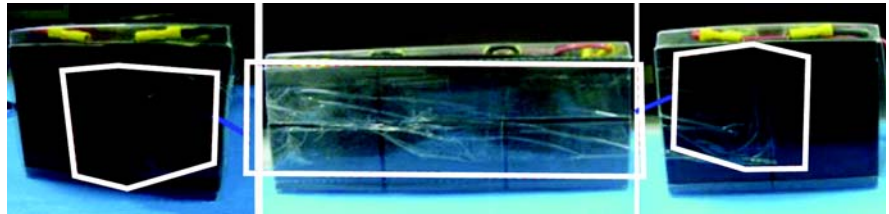

5. Insert the batteries into the battery compartment in the orientation as shown in the photo below.

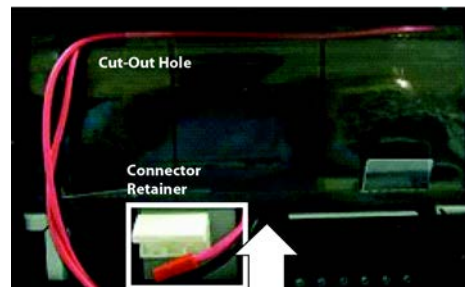

6. Open the white connector retainer and connect the two cables together as shown in the photo below.

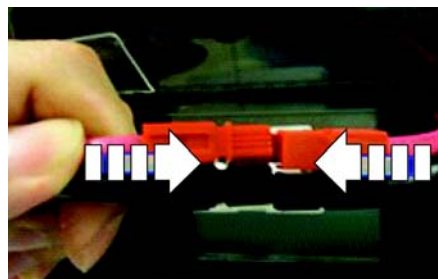



## Battery Wiring and Installation (cont.)

- To complete the battery installation, insert the surplus wire harness into the free space, close the white connector retainer and reattach the battery door with the six screws (torque of 8.7+/-1.7 lb-in).



## Mount the 1609-EXBAT

The 1609-D UPS can be used with the External Battery Unit (1609-EXBAT). The 1609-EXBAT unit is designed to mount to a heavy duty DIN-rail (see Figure 6) or the optional mounting bracket assembly (1609-BRK) which allows it to mount to either the panel or floor (see Figure 7).

**Figure 6 - Heavy Duty DIN Rail Mount**

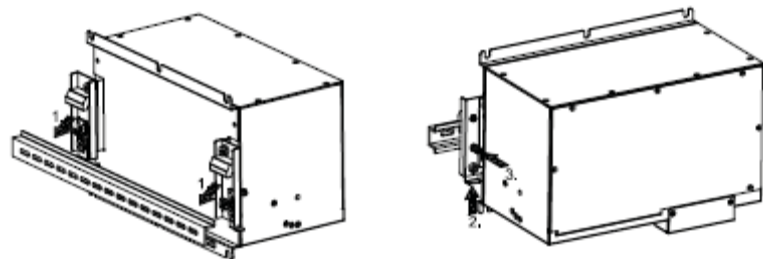

**Figure 7 - Panel or Floor Mount**

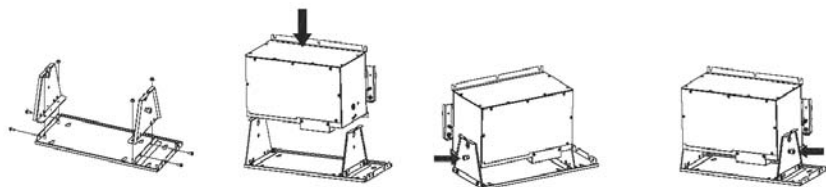

## Selection of Cables

**Table 4 - DC Input/Output Wiring for External Battery Cabinet**

Item	Specification
Wire Size	10 AWG
Minimum temperature	75 °C
Wire conductor material	Copper only
Tightening torque for terminals	12 lb-in.

## Connect 1609-EXBAT to the UPS

To install the 1609-EXBAT unit with the 1609-D UPS, connect the three 10 AWG wires from the 1609-EXBAT terminals to the 1609-D UPS terminals marked as ‘EXTERNAL BATT PACK (36V)’. (See Figure 8)

Dispose of used batteries according to the battery instructions.

**Figure 8 - System Wiring**

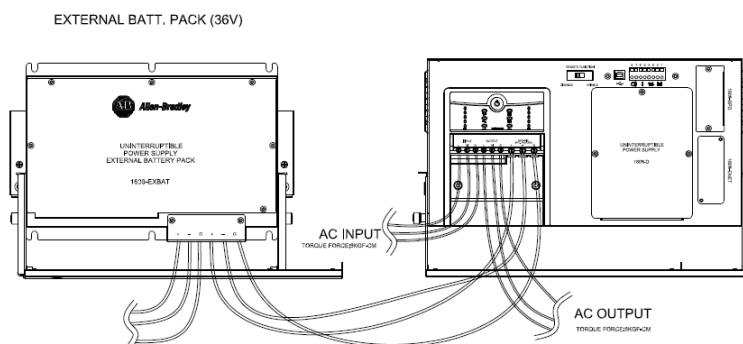

## General Information 1609-D and 1609-B UPS Units

### Recommended Battery for Use with the UPS and 1609-EXBAT

Rockwell Automation battery catalog numbers 1609-SBAT and 1609-HBAT consist of the battery manufacturers listed below:

Manufacturer	MH Number	Type	Rating
B & B Battery (USA)	MH19884	HRL5 5.5-12	12V DC, 2.75 Ah
		BP 5-12	12V DC, 5.0 Ah
		HR 5.5-12	12V DC, 2.75 Ah
		SHR7-12	12V DC, 3.375 Ah
GS Yuasa International Ltd.	MH12970	NPH5-12	12V DC, 5.0 Ah
Shenzhen Center Power Tech Co., Ltd.	MH25860	CP1250	12V DC, 5.0 Ah
Shenzhen Ritar Power Co., Ltd.	MH28539	RT1250	12V DC, 5.0 Ah
CSB Battery Co., Ltd.	MH14533	HR1221W	12V DC, 5.25 Ah

Not for use in a computer room as defined in the Standard for the Protection of Electronic Computer/Data Processing Equipment, ANSI/NFPA 75.



Dispose of used batteries according to the battery instructions.

### Dry I/O Contacts

There is one Remote Enable/Disable Switch connection and 3 Dry I/O Contacts available on the front of the UPS. Do not apply external power to the Remote Enable/Disable Switch; however, the 3 sets of Dry Contacts require external power supplies (Contacts Rating is 1A/24V DC). Each of the dry contacts is used to provide a remote status indication of the UPS, as follows:

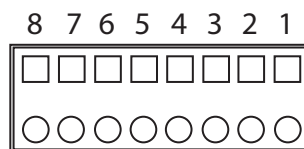

- 1 and 2 On Battery Contact (NO)
- 3 and 4 Low Battery Contact (NO)
- 5 and 6 Fault (Indicates UPS has faulted see trouble shooting section)
- 7 and 8 Remote On/O (Shorted (closed) for ON, Open for OFF)



### USB Communication Port

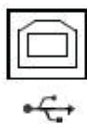

The UPS supports a USB communication port for the end user to connect with a computer. The user may monitor all the UPS status through the USB port if the 1609 UPS Management Software is installed in the computer. The software is stored in the CD and can be found in the accessory bag.

## Manual or Remote Enable/Disable of UPS Output Selection

The 1609 UPS output is designed to be manually or remotely enabled or disabled. User is required to enable or disable the remote function switch on the front panel.

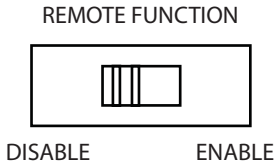

- Selected 'DISABLE' for Manual Enable/Disable the UPS's Output.
- Selected 'ENABLE' for Remote Enable/Disable the UPS's Output.

## Manual Enable/Disable/Self-test

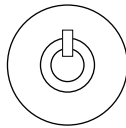

The Power Button on the front of the UPS is used to manually enable or disable the output of the 1609-D UPS.

To enable the 1609-D UPS, press and hold the power button until one beep is heard.

To disable the 1609-D UPS, press and hold the power button until three beeps are heard, then release immediately (takes approximately 3 seconds).

To perform a self-test, press and hold the power button until two beeps are heard, then release immediately. (The UPS must operate for at least 4 hours before executing this function)

## Remote Enable/Disable



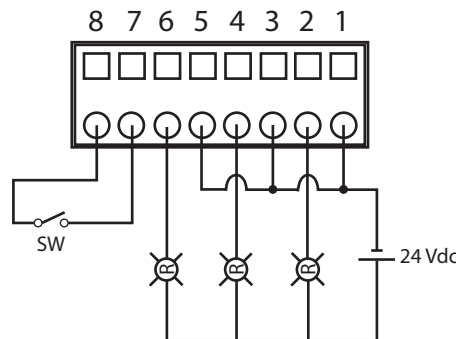



An external switch connected to the Dry I/O terminals 7 and 8 is required to remotely Enable or Disable the UPS output.



To enable the UPS, close the switch that is connected to the Dry I/O terminals 7 and 8.

To Disable the UPS, open the switch that is connected to the Dry I/O terminals 7 and 8.

## Display LED Indicators

Indicator LED	Indicator Title	Description
	Online	The UPS is supplying utility power to the connected equipment (see Troubleshooting).
	AVR Trim <sup>❶</sup>	The UPS is compensating for a high utility voltage (see Troubleshooting).
	AVR Boost <sup>❶</sup>	The UPS is compensating for a low utility voltage (see Troubleshooting).
	On Battery	The UPS is supplying battery power to the connected equipment.
	Overload	The connected equipment is drawing more than the UPS power rating allows (see Troubleshooting).
	Replace Battery/Disconnect	The battery is disconnected or must be replaced (see Troubleshooting).

<sup>❶</sup> Applies to 1609-D only

# Troubleshooting

Button	Function	Explanation
	UPS Output Enable	Press and hold the button until one beep is heard, then release immediately
	UPS Output Disable	Press and hold the button until three beeps are heard, then release immediately
	Self-Test	Press and hold the button until two beeps are heard, then release immediately (The UPS must operate for at least 4 hours before executing this function)

Problem	Possible Cause	Solution
<b>No LED illuminates / No alarm</b>	UPS output is disabled or input utility power is not present	Have qualified electrician trouble shoot the input utility power system and make the necessary corrections.
<b>No UPS output</b>	The UPS has not been enabled	<b>Manually Enable</b> - Make sure the Remote Function selector switch is in the Disable position, then press and hold the UPS Power button until one beep is heard and release immediately. <b>Remotely Enable</b> - Make sure the Remote Function selector switch is in the Enable position and verify that there is an adequate connection to the remote on/off dry I/O connection (terminals 7 & 8)
<b>UPS Operates on battery although input utility voltage exists</b>	The system may experience high, low or distorted input utility voltage	Reduce the UPS sensitivity by using the 1609 UPS Management software. If the problem persists, move or connect the UPS with a known good quality utility power source.
<b>Input line utility power circuit breaker trip</b>	The system may have experienced an overload	Verify that the circuit breaker is sized properly. Verify the load connected to the output of the UPS. Ensure that the load does not exceed the output rating of the UPS.
<b>FAULT LED illuminates</b>	An internal fault has been detected	Refer to the UPS LED Fault Indicators below to identify the specific fault that occurred and possible resolution.
<b>ONLINE LED illuminates, but no UPS output is available</b>	The UPS output connection may not be connected properly	Disable the UPS output and have qualified electrician troubleshoot the output connection system and make the necessary corrections.
<b>The battery did not provide expected runtime</b>	The batteries might be weak or the lifespan is due	Charge the batteries for 8 hours and retest the runtime. If the runtime is still less than expected after charging, replace the batteries even if the Replace Battery LED doesn't illuminate.
<b>No communication between the UPS and your PC</b>	Wrong cable	Verify cable used.
	The connection cable is not firmly connected	Reconnect the communication cable firmly.
	PC Communication Port may have been used by another process or is defective	Check if there is other software or service accessing the Communication Port on your PC, or connect it to a different communication port.
	There is interference on the connection cable	Lay the cable differently or away from other cables and reconnect the cable.

## UPS LED Fault Indicators

### General Clear Fault Procedure

Press and hold the button until three beeps are heard then release immediately to turn the UPS off then press and hold the button again until one beep is heard then release to enable the output.

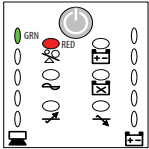
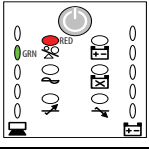
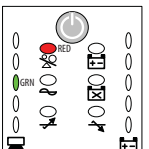
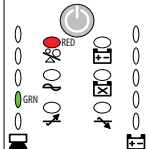
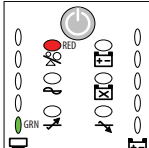
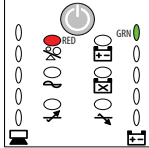
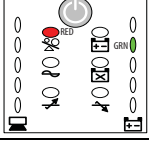
No.	Fault	Description	Solution
1	Output Short Circuit 	The UPS has detected a short circuit on the Output of the UPS and disabled its output.	Have a qualified electrician troubleshoot the load connected to the output to the UPS and remove the short circuit if present.
2	Output Overload 	The UPS has detected an overload and disabled its output.	To clear fault, follow the General Clear Fault Procedure described above. If the problem persists, contact Technical Support. Verify the load connected to the output of the UPS. Ensure that the load does not exceed the output rating of the UPS. If the load exceeds the rating of the UPS please remove excess load or select the appropriate size UPS. If the problem persists, contact Technical Support. To clear fault, follow the General Clear Fault Procedure described above.
3	Over Temperature from the Heatsink 	The UPS has detected an over temperature of the heatsink and disabled its output.	Have a qualified electrician checked the ambient temperature to make sure that it does not exceed 40 °C (1609-SBAT) or 50 °C (1609-HBAT). If it is over temperature, make the necessary correction to the system. This issue may be corrected by improving the room ambient temperature (add ventilation or provide air conditioning). To clear fault, follow the General Clear Fault Procedure described above.
4	Over Ambient Temperature 	The UPS has detected an over ambient temperature and disabled its output.	Have a qualified electrician checked the ambient temperature to make sure that it does not exceed 40 °C (1609SBAT) or 50 °C (1609-HBAT). If it is over temperature, make the necessary correction to the system. This issue may be corrected by improving the room ambient temperature (add ventilation or provide air conditioning). To clear fault, follow the General Clear Fault Procedure described above.
5	Over Voltage from The DC/DC Converter of Inverter 	The UPS has detected an over voltage of the DC/DC Converter and disabled its output.	Have a qualified electrician verify that the quality of utility voltage is within specification. To clear the fault, follow the General Clear Fault Procedure described above. If the fault is still present after attempting to clear fault, contact Technical Support.
6	Over Voltage from The Inverter 	The UPS has detected high voltage on the inverter and disabled its output.	Have a qualified electrician verify that the quality of utility voltage is within specification. To clear fault, follow the General Clear Fault Procedure described above. If the fault is still present after attempting to clear fault, contact Technical Support.
7	Under Voltage from The Inverter 	The UPS has detected low voltage on the inverter and disabled its output.	Have a qualified electrician verify that the quality of utility voltage is within specification. To clear fault, follow the General Clear Fault Procedure described above. If the fault is still present after attempting to clear fault, contact Technical Support.

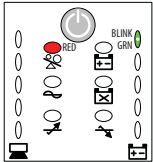
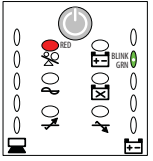
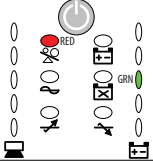
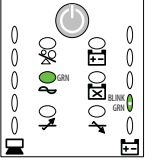
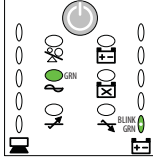
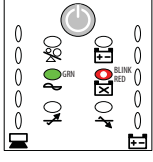
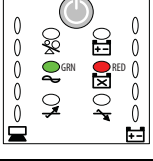
No.	Fault	Description	Solution
8	<b>Over Voltage from The Output of AVR</b> 	The UPS has detected an over voltage on the output of AVR and disabled its output.	Have qualified electrician verify that the quality of the output voltage and the input utility voltage are within its specification. To clear fault, follow the General Clear Fault Procedure described above and if the problem persists, contact Technical Support.
9	<b>Under Voltage from The Output of AVR</b> 	The UPS has detected low voltage on the output of AVR and disabled its output.	Have qualified electrician verify that the quality of the output voltage and the input utility voltage are within its specification. To clear fault, follow the General Clear Fault Procedure described above and if the problem persists, contact Technical Support.
10	<b>Fan Failure</b> 	The UPS has detected that the fan of the UPS has failed and disabled its output.	To clear fault, follow the General Clear Fault Procedure described above and if the Fan Failure persists, contact Technical Support.
11	<b>Charger Failure</b> 	The UPS has detected that the battery charger circuit has failed; however, the UPS will continue running.	Clear this fault by removing the input utility voltage and batteries then plug the batteries back in place and turn the input utility voltage back on. Enable the UPS output to verify the fault. If the Charger Failure persists, contact Technical Support.
12	<b>TMOV Failure</b> 	The UPS has detected that the MOV circuit has failed; however, the UPS will continue enabling the output.	Schedule to have a qualified electrician replace the MOV board (1609-SPD). Remove the input utility power before service on this 1609-SPD due to risk of electrical shock.
13	<b>Missing Battery</b> 	The UPS has detected that the batteries are missing; however, the UPS will continue enabling the output.	Have a qualified electrician verify the battery connection for good contact and charge the batteries for 24 hours. To clear fault, follow the General Clear Fault Procedure described above. If the battery status still indicates Missing Battery, new batteries are required.
14	<b>Replace Batteries</b> 	The UPS has detected that the batteries are bad; however, the UPS will continue running.	Have a qualified electrician verify the battery connection for good contact and charge the batteries for 24 hours. To clear fault, follow the General Clear Fault Procedure described above. If the battery status still indicates Replace Battery, new batteries are required.



## Bulletin 1609 UPS Management Software Troubleshooting

### General Clear Fault Procedure

Press and hold the button until three beeps are heard then release immediately to turn the UPS off then press and hold the button again until one beep is heard then release to enable the output.

Status Indications	Indication Description	Solution
Buzzer Alarm	The UPS has detected a fault and generate a buzzer alarm.	Verify the type of fault from the Status Indicators or the LEDs on the UPS for further troubleshooting.
Test In Progress	The UPS is currently in a test mode.	Do not interrupt the UPS testing. The UPS is doing battery test.
UPS Fault	The UPS has detected a fault and disabled its output.	Verify the type of fault from the Status Indicators or the LEDs on the UPS for further troubleshooting. To clear fault, follow the General Clear Fault Procedure described above and if the fault persists, contact Technical Support.
Battery Low	The UPS has detected that the batteries are low.	The batteries must be charged for 24 hours and re-verify the battery status. If the batteries still indicate to be low, replace the batteries.
Power Failed	The UPS has detected that the input utility voltage has failed.	Verify that the input utility voltage is within the UPS's input specification. If it is not, make the necessary correction to the input utility power system.
Overheat	The ambient temperature is greater than 60 °C, or some internal components are over temperature.	Have a qualified electrician checked the ambient temperature to make sure that it does not exceed 40 °C (1609-SBAT) or 50 °C (1609-HBAT). If the temperature exceeds the UPS rating, make the necessary correction to the system. This issue may be corrected by improving the room ambient temperature (add ventilation or provide air conditioning). To clear fault, follow the General Clear Fault Procedure described above and if the fault persists, contact Technical Support.
Overload	The UPS has detected that output load of UPS is greater than 110%.	Verify that the load does not exceed the load specification. If it is, remove the excess load from the UPS's output and clear its fault. If the problem persists, have a qualified electrician troubleshoot the UPS Load System and make the necessary corrections or select the appropriate size of UPS. If the problem persists, contact Technical Support.
Load Warning	The output load over the warning threshold.	Verify the output load. If it is close to 100% load, remove the excess load or select the appropriate size of UPS.
Load Severity	The output load over the severity threshold.	Verify the output load. If it is actually at 100% load, remove some of the non-essential load or select the appropriate size of UPS.
UPS Disconnect	The UPS has detected a communication loss between the UPS and the computer.	Please check the USB cable between computer and UPS for secure connection or replace the cable with a known good cable. If communication is established, re-open the UPS Management software. If the problem persists, contact Technical Support.
Output Abnormal	To indicate the output voltage is abnormal.	Have qualified electrician verify that the quality of the output voltage and the input utility voltage are within its specification. To clear fault, follow the General Clear Fault Procedure described above and if the problem persists, contact Technical Support.
Output Off	The UPS is operating in standby mode, or UPS is faulted.	If it is identified as the UPS fault shutdown then turn the UPS off, and then turn UPS on again to reset the fault. If the fault persists, contact Technical Support.
UPS System Off	The UPS system is in the standby state.	If it is identified as the UPS fault shutdown then turn the UPS off. Turn UPS on again to reset the fault. If the fault persists, contact Technical Support.
Awaiting Power	The battery is depleted and the UPS awaits the return of input utility voltage.	Apply the input utility voltage to the UPS.
Battery Need Replace	The UPS has detected that the battery is bad or opened.	Have a qualified electrician verify the battery connection for good contact and charge the batteries for 24 hours. To clear fault, follow the General Clear Fault Procedure described above. If the battery status still indicates Battery Need Replace, new batteries are required.
Battery Depleted	The UPS has detected that the batteries are depleted.	Have a qualified electrician verify the battery connection for good contact and charge the batteries for 24 hours. To clear fault, follow the General Clear Fault Procedure described above. If the battery status still indicates Battery Depleted, new batteries are required.

## Bulletin 1609 Network Management Card Troubleshooting

### General Clear Fault Procedure

Press and hold the button until three beeps are heard then release immediately to turn the UPS off then press and hold the button again until one beep is heard then release to enable the output.

Status Indications	Indication Description	Solution
UPS Disconnect	The communication between UPS and the 1609-ENET card has been disconnected.	Check the 1609-ENET LEDs for the communication status and the operation of UPS. If the UPS is operating normal but the LEDs of the 1609-ENET card are not working properly, make sure the cable is securely connected from the 1609-ENET card to the computer. If the LEDs of the 1609-ENET card is still not working properly, apply a known good 1609-ENET card to verify whether the failure is on the UPS or the 1609-ENET.
Buzzer Alarm	The UPS has detected a fault and generated a buzzer alarm.	Please verify the type of fault from the Status Indicators or the LEDs on the UPS for further troubleshooting.
Input Out Of Range	The UPS has detected that the input utility voltage is out of range.	Verify that the input utility voltage is within the UPS's input specification. If it is not, makes the necessary correction to the input utility power system.
Battery Low	The UPS has detected that the batteries are low.	The batteries must be charged for 24 hours. After charging batteries verify the battery status. If the batteries still indicate that they are low, replace the batteries.
Battery Depleted	The UPS has detected that the batteries are depleted.	Have a qualified electrician verify the battery connection for good contact and charge the batteries for 24 hours. To clear fault, follow the General Clear Fault Procedure described above. If the battery status still indicates Battery Depleted, new batteries are required.
Battery Need Replace	The UPS has detected that the battery is bad or opened.	Have a qualified electrician verify the battery connection for good contact and charge the batteries for 24 hours. To clear fault, follow the General Clear Fault Procedure described above. If the battery status still indicates Battery Need Replace, new batteries are required.
Test In Progress	The UPS is currently in a test mode.	Do not interrupt the UPS testing.
Test Fail	The UPS has detected that the battery is bad.	Verify that the battery is not disconnected or replace the batteries with a brand new set of batteries. Ensure the UPS ran for at least 4 hours before test.
Output Off	The UPS is operating in standby mode or fault shutdown.	If it is identified as the UPS fault shutdown then turn the UPS off, and then turn UPS on again to reset the fault. If the fault persists, contact Technical Support.
UPS System Off	The UPS system is in the standby state.	If it is identified as the UPS fault shutdown then turn the UPS off, and then turn UPS on again to reset the fault. If the fault persists, contact Technical Support.
UPS Shutdown	The UPS was commanded to shut down or fault shutdown.	If it is identified as the UPS fault shutdown then turn the UPS off, and then turn UPS on again to reset the fault. If the fault persists, contact Technical Support.
Output Over Voltage	The UPS has detected that the output voltage is above the UPS's output specification.	Have qualified electrician verify that the quality of the output voltage and the input utility voltage are within its specification. To clear fault, follow the General Clear Fault Procedure described above and if the problem persists, contact Technical Support.
Output Under Voltage	The UPS has detected that the output voltage is below the UPS's output specification.	Have qualified electrician verify that the quality of the output voltage and the input utility voltage are within its specification. To clear fault, follow the General Clear Fault Procedure described above and if the problem persists, contact Technical Support.
Overload	The UPS has detected that the UPS's output load is greater than 110%.	Verify that the load does not exceed the load specification. If it is, remove the excess load from the UPS's output and clear the fault. If the problem persists, have a qualified electrician troubleshoot the UPS Load System and make the necessary corrections or select the appropriate size of UPS. If the problem persists, contact Technical Support.
Over Temperature	The UPS has detected that the ambient temperature is greater than 60 °C, or some of the internal components are over temperature.	Have a qualified electrician check the ambient temperature to make sure that it does not exceed 40°C (1609-SBAT) or 50°C (1609-HBAT). If it is over, make the necessary correction to the system. This issue may be corrected by improving the room ambient temperature (add ventilation or provide air conditioning). Following the General Clear Fault Procedure to clear this fault.
Fan Abnormal	The UPS has detected that the UPS's fan has failed.	To clear fault, follow the General Clear Fault Procedure described above and if the Fan Failure persists, contact Technical Support.
Inverter Abnormal	The UPS has detected that the UPS inverter circuit has failed.	Have a qualified electrician verify that the quality of utility voltage is within specification. To clear fault, follow the General Clear Fault Procedure described above and if the Inverter Failure persists, contact Technical Support.
Charger Abnormal	The UPS has detected that the UPS battery charger circuit has failed.	Clear this fault by removing the input utility voltage and batteries. Plug the batteries back in place and turn the input utility voltage back on. Enable the UPS output to verify the fault. If the Charger Failure persists, contact Technical Support.

Technical Specifications — 1609-D, 120V		1609-D600N	1609-D1000N	1609-D1500N
Input	V nom.	120V		
	Capacity	600 VA (390 W)	1000 VA (650 W)	1500 VA (980 W)
	Voltage Range, default	90...145V		
	Voltage Range, widest online	90...145V		
	Current nom.	5.5 A	8.8 A	13 A
	Capacity Frequency	50/60 Hz ± 3 Hz		
	PFC	None		
Output	V nom.	120V		
	Capacity	600 VA (390 W)	1000 VA (650 W)	1500 VA (980 W)
Online	Output Voltage Range, default	108...132V		
	Output Voltage Range, widest online	108...132V		
	Transfer Point Accuracy	± 3 %		
On Battery	V nom	120V (sine wave)		
	Frequency	50/60 Hz ± 0.5Hz		
	THD	≤ 10% Full Linear Load		
Short Circuit Protection	Crest Factor	2.2:1		
Efficiency	On Battery (Typical with resistive load)	75%		
	Online - Typical with resistive load excluding AVR mode)	86%	94%	95%
Protection	Surge	380 Joules		
	Overload (Shutdown after 10 s)	> 110...130%		
	Overload (Shutdown immediately)	> 130%		
	Output Short Online/Battery	Premises branch circuit over-current protection/Shutdown		
	Thermal Protection	UPS inside temperature ≥ 60 °C		
Regulatory	Safety	UL1778, CSA C22.2 No. 107.3, EN/IEC62040-1		
	EMC	FCC & CE (EN 62040-2)		
	Markings	UL, cULus, FCC, CE, C-Tick		
Battery Pack	Run Time	≥5 min (at 25 °C, full R load)	≥3.5 min (25 °C, full R load)	≥2.5 min (at 25 °C, full R load)
	Type	Sealed Lead Acid Battery 12V/5Ah (for 0...40 °C B.B. BP5-12) 12V/5.5Ah (for 0...50 °C B.B. HRL5.5-12)		
	Voltage	36V		
	Charger	Current limited, constant voltage float charger		
	Recharger Time	Less than 8 hr to 90% capacity after discharge with full load		
	Lifetime	2...3 years at 25 °C ambient temperature		
Environment	Temperature	Operating Standard Battery 0...+40 °C (+32...+104 °F) Hi-Temperature Battery 0...+50 °C (+32...+122 °F) Non-operating/Storage -15...+45 °C (+5...+113 °F)		
	Altitude	Operating 0...6600 feet (0... 2000 meters)		
	Humidity	Operating/Storage 5...95% RH (Non-condensing)		
	Heat Output	On Line, Full load: 217 BTU/hr On Line, Full load, Charging: 296 BTU per hour On Battery: Full Load: 1331 BTU per hour	On Line, Full load: 142BTU/hr On Line, Full load, Charging: 221 BTU per hour On Battery: Full Load: 2218BTU per hour	On Line, Full load: 176BTU/hr On Line, Full load, Charging: 256BTU per hour On Battery: Full Load: 3344BTU per hour
	Audible Noise	< 50 dBA @ Front Side 1 Meter		
Mechanical	Approximate Dimensions L*W*H In. (mm)	8.66 x 16.14 x 10.24 (220 x 410 x 260)		
	Approximate Weight lbs (kg)	29.7 (13.5)	30.1 (13.7)	31 (14.1)

Technical Specifications — 1609-D, 230V		1609-D600E	1609-D1000E	1609-D1500E
Input	V nom.	230V		
	Capacity	600 VA (390W)	1000 VA (650W)	1500 VA (980 W)
	Voltage Range, default	180...280V		
	Voltage Range, widest online	180...280V		
	Current nom.	3.3 A	4.7 A	7.1 A
	Capacity Frequency	50/60 Hz ±3Hz		
	PFC	None (load power factor is reflected in the input line current)		
Output	V nom.	230V		
	Capacity	600 VA (390 W)	1000 VA (650 W)	1500 VA (980 W)
Online	Output Voltage Range, default	207...253V		
	Output Voltage Range, widest online	207...253V		
	Transfer Point Accuracy	±3%		
On Battery	V nom	230V (Sine Wave)		
	Frequency	50/60 Hz ±0.5 Hz (Factory default: 50 Hz ± 0.5 Hz)		
	THD	≤ 10% (Full Linear Load)		
Short Circuit Protection	Crest Factor	2.2:1		
Efficiency	On Battery (Typical with resistive load)	75%(Typical with resistive load)		
	Online - Typical with resistive load excluding AVR mode)	86%	94%	95%
Protection	Surge	660 Joules (Total performance rated with 10 x 1000 µs Pulse)		
	Overload (Shutdown after 10 s)	> 110...130%		
	Overload (Shutdown immediately)	> 130%		
	Output Short Online/Battery	Premises branch circuit over-current protection/Shutdown		
	Thermal Protection	UPS inside temperature ≥ 60 °C		
Regulatory	Safety	UL1778, CSA C22.2 No. 107.3-5, EN/IEC62040-1		
	EMC	FCC & CE (Class A)		
	Markings	UL, cULus, FCC, CE		
Battery Pack	Run Time	≥5 min (at 25 °C, full R load)	≥3.5 min (25 °C, full R load)	≥2.5 min (at 25 °C, full R load)
	Type	Sealed Lead Acid Battery 12V/5Ah (for 0...40 °C B.B. BP5-12) 12V/5.5Ah (for 0...50 °C B.B. HRL5.5-12)		
	Voltage	36V		
	Charger	Current limited, constant voltage float charger		
	Recharger Time	Less than 8 hr to 90% capacity after discharge with full load		
	Lifetime	2...3 years at 25 °C ambient temperature		
Environment	Temperature	Operating Standard Battery 0...+40 °C (+32...+104 °F) Hi-Temperature Battery 0...+50 °C (+32...+122 °F) Non-operating/Storage -15...+45 °C (+5...+113 °F)		
	Altitude	Operating 0...6600 feet (0... 2000 meters)		
	Humidity	Operating/Storage 5...95% RH (Non-condensing)		
	Heat Output	On Line, Full load: 217 BTU/hr On Line, Full load, Charging: 296 BTU per hour On Battery: Full Load: 1331 BTU per hour	On Line, Full load: 142BTU/hr On Line, Full load, Charging: 221 BTU per hour On Battery: Full Load: 2218BTU per hour	On Line, Full load: 176BTU/hr On Line, Full load, Charging: 256BTU per hour On Battery: Full Load: 3344BTU per hour
	Audible Noise	< 50 dBA @ Front Side 1 Meter		
Mechanical	Approximate Dimensions L*W*H In. (mm)	16.15 x 8.67 x 10.24 (410 x 220 x 260 )		
	Approximate Weight lbs (kg)	29.7 (13.5)	30.1 (13.7)	31 lb (14.1)

Technical Specifications — 1609-B, 120V		1609-B600N	1609-B1000N
Input	V nom.	120V	120V
	Capacity	600 VA (360 W)	1000 VA (600 W)
	Voltage Range, default	96...138V	
	Voltage Range, widest online	96...138V	
	Current nom.	5.4 A	8.9 A
	Capacity Frequency	50/60 Hz ± 3 Hz	50/60 Hz ± 3 Hz
	PFC	None	None
Output	V nom.	120V	
	Capacity	600 VA (360 W)	1000 VA (600 W)
Online	Output Voltage Range, default	96...138V	
	Output Voltage Range, widest online	96...138V	
	Transfer Point Accuracy	± 3%	
On Battery	V nom	120V (step wave)	
	Frequency	50/60 Hz ± 1 Hz	
	THD	47.5% (step wave)	47.6% (step wave)
Short Circuit Protection	Crest Factor	2.5:1	
Efficiency	On Battery (Typical with resistive load)	80% Typical with resistive load	
	Online - Typical with resistive load excluding AVR mode)	94% Typical with resistive load	
Protection	Surge	380 Joules (Total performance rated with 10*1000 μ s pulse)	
	Overload (Shutdown after 10 s)	> 110...130% - shutdown after 5 sec	
	Overload (Shutdown immediately)	130% shutdown immediately	
	Output Short: Online	Premises branch circuit over-current protection	
	Output Short: Battery	Shutdown	
	Thermal Protection	UPS inside temperature ≥ 70 °C	
Regulatory	Safety	UL1778, CSA C22.2 No. 107.3-05, EN/IEC62040-1	
	EMC	FCC & CE (Class A)	
	Markings	UL, cULus, FCC, CE, C-Tick	
Battery Pack	Run Time	≥5 min (at 25 °C, full load = 360W, PF = 0.6...0.75)	≥2 min (at 25 °C, full load = 600W, PF = 0.6...0.75)
	Type	Sealed Lead Acid Battery	
		12V/5Ah (for 0...40 °C: B.B. BP5...12)	
		12V/5.5 Ah (for 0...50 °C: B.B. HRL5.5...12)	
	Voltage	24V	
	Charger	Current limited, constant voltage float charger	
	Recharger Time	Less than 12 hrs to 90% capacity after discharge with full load	
Lifetime	2...3 years at 25 °C ambient temperature		
Environment	Temperature	Operating Standard Battery 0...+40 °C (+32...+104 °F) Hi-Temperature Battery 0...+50 °C (+32...+122 °F) Non-operating/Storage -15...+45 °C (+5...+113 °F)	
	Altitude	Operating 0...6600 feet (0... 2000 meters)	
	Humidity	Operating/Storage 5...95% RH (Non-condensing)	
	Heat Output	On Line, Full load: 107 BTU/hr On Line, Full load, Charging: 160 BTU per hour On Battery: Full Load: 1228 BTU per hour	On Line, Full load: 178 BTU/hr On Line, Full load, Charging: 231 BTU per hour On Battery: Full Load: 2047 BTU per hour
	Audible Noise	< 45 dBA @ Front Side 1 Meter	
Mechanical	Approximate Dimensions L*W*H In. (mm)	6.1 x 11 x 7.09 (155 x 300 x 180)	
	Approximate Weight lbs (kg)	14.5 (6.6)	14.7 (6.7)

Technical Specifications — 1609-B, 230V		1609-B600E	1609-B1000E
Input	V nom.	230V	230V
	Capacity	600 VA (360 W)	1000 VA (600 W)
	Voltage Range, default	184...265V	
	Voltage Range, widest online	184...265V	
	Current nom.	2.8 A	4.7 A
	Capacity Frequency	50/60 Hz $\pm$ 3 Hz	
	PFC	None (Load power factor is reflected in the input line current)	
Output	V nom.	230V	
	Capacity	600 VA (360 W)	1000 VA (600 W)
Online	Output Voltage Range, default	184...265V	
	Output Voltage Range, widest online	184...265V	
	Transfer Point Accuracy	$\pm$ 3% V AC	
On Battery	V nom	230V (step wave)	
	Frequency	50/60 Hz $\pm$ 1 Hz	
	THD	N/A	N/A
Short Circuit Protection	Crest Factor	2.5:1	
Efficiency	On Battery (Typical with resistive load)	70% Typical with resistive load	
	Online - Typical with resistive load excluding AVR mode)	93% Typical with resistive load	
Protection	Surge	440 Joules (Total performance rated with 10*1000 $\mu$ s pulse)	
	Overload (Shutdown after 5s)	> 110...130%	
	Overload (Shutdown immediately)	> 130%	
	Output Short: Online	Premises branch circuit over-current protection	
	Output Short: Battery	Shutdown	
	Thermal Protection	UPS inside temperature $\geq$ 70 °C	
Regulatory	Safety	UL1778, CSA C22.2 No. 107.3-05, EN/IEC62040-1	
	EMC	FCC & CE (Class A)	
	Markings	UL, cULus, FCC, CE	
Battery Pack	Run Time	$\geq$ 5 min (at 25 °C, full load = 360W, PF = 0.6...0.75)	$\geq$ 2 min (at 25 °C, full load = 600W, PF = 0.6...0.75)
	Type	Sealed Lead Acid Battery	
		12V/5Ah (for 0...40 °C: B.B. BP5...12)	
		12V/5.5 Ah (for 0...50 °C: B.B. HRL5.5...12)	
	Voltage	24V	
	Charger	Current limited, constant voltage float charger	
	Recharger Time	Less than 12 hrs to 90% capacity after discharge with full load	
Lifetime	2...3 years at 25 °C ambient temperature		
Environment	Temperature	Operating Standard Battery 0...+40 °C (+32...+104 °F) Hi-Temperature Battery 0...+50 °C (+32...+122 °F) Non-operating/Storage -15...+45 °C (+5...+113 °F)	
	Altitude	Operating 0...6600 feet (0... 2000 meters)	
	Humidity	Operating/Storage 5...95% RH (Non-condensing)	
	Heat Output	On Line, Full load: 107 BTU/hr On Line, Full load, Charging: 160 BTU per hour On Battery: Full Load: 1228 BTU per hour	On Line, Full load: 178 BTU/hr On Line, Full load, Charging: 231 BTU per hour On Battery: Full Load: 2047 BTU per hour
	Audible Noise	< 45 dBA @ Front Side 1 Meter	
Mechanical	Approximate Dimensions LxWxH In. (mm)	13.4 x 7.29 x 8.27 (340 x 185 x 210)	
	Approximate Weight lbs (kg)	14.5 (6.6)	14.7 (6.7)

## 1609 UPS Dimensions

### 1609-D UPS Dimensions

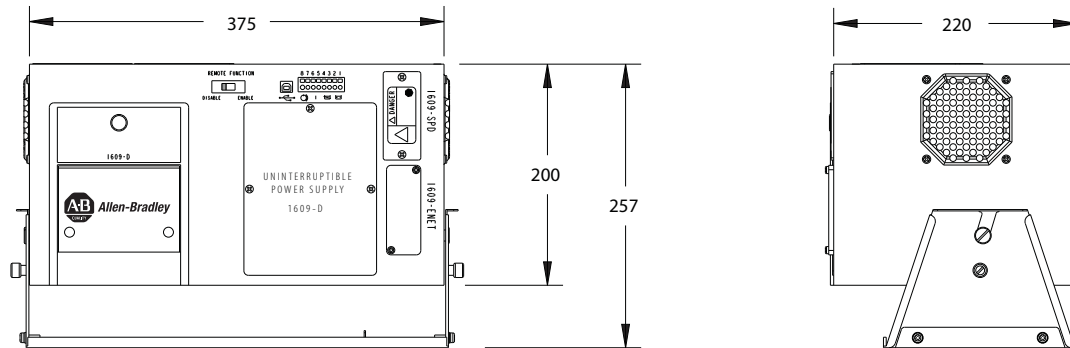

### 1609-B UPS Dimensions

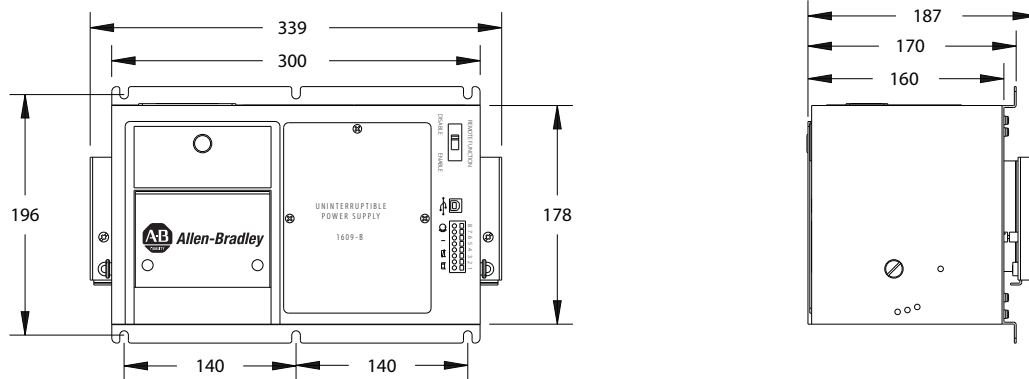

### 1609-EXBAT Unit Dimensions

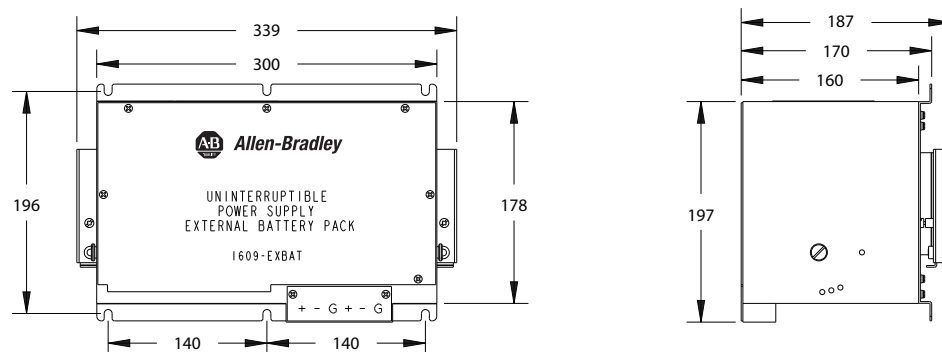

### 1609-BRK Dimensions (1609-D orientation)

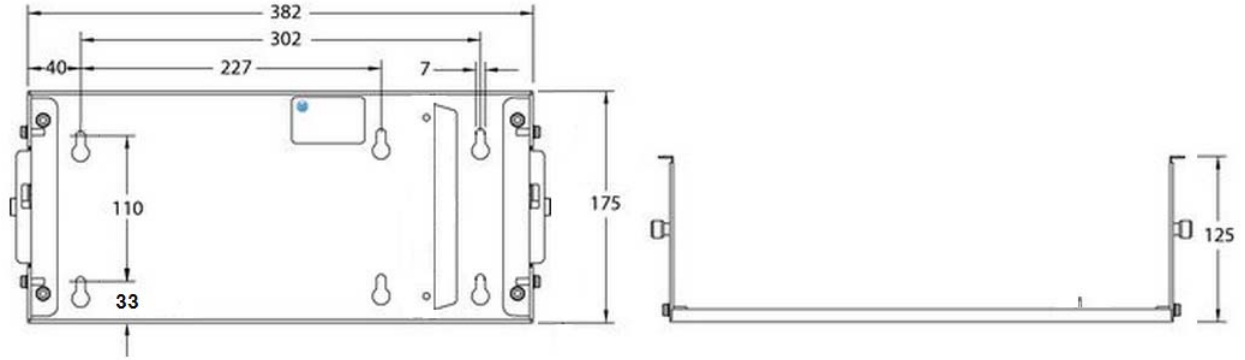

### 1609-BRK Dimensions (1609-B orientation)

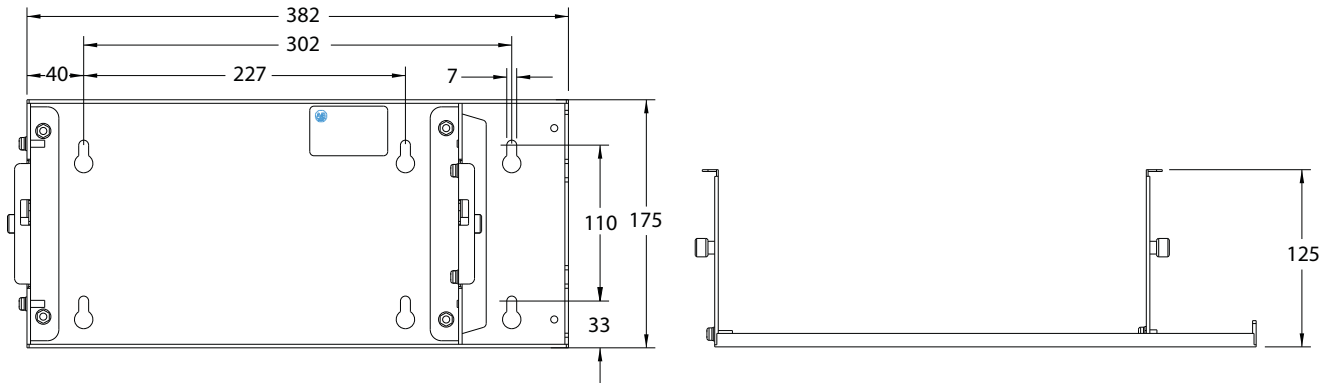



## Service Instructions

If the UPS requires service, do not return it to the distributor. Follow these steps:

1. Servicing of batteries should be performed or supervised by personnel knowledgeable of batteries and the required precautions. Keep unauthorized personnel away from batteries.
2. When replacing batteries, replace with the same number of the 1609 battery packs supplied by Rockwell Automation.



**WARNING:** Do not dispose of battery in a fire. The battery may explode. Do not open or mutilate the battery or batteries. Released electrolytes are harmful to the skin and eyes. It may be toxic. A battery can present a risk of electrical shock and high short circuit current.

---

3. Review the problems discussed in the Troubleshooting section of this manual to eliminate common problems.
4. If the problem persists, contact Rockwell Automation Customer Support at 440-646-5800.
5. Pack the UPS in its original packaging.
  - Pack the UPS properly to avoid damage in transit. Never use Styrofoam beads for packaging.
  - Damage sustained in transit is not covered under warranty.



**ATTENTION:** Always disconnect the battery(s) before shipping, in compliance with U.S. Department of Transportation (DOT) and IATA regulations. The battery(s) may remain in the UPS.

---

The following precautions should be observed when working on batteries:

- Remove watches, rings, or other metal objects.
- Use tools with insulated handles.
- Do not lay tools or metal parts on top of batteries.
- Determine if battery is inadvertently grounded. If inadvertently grounded, remove source from ground. Contact with any part of a grounded battery can result in electrical shock. The likelihood of such shock can be reduced if such grounds are removed during installation and maintenance.

## Rockwell Automation Support

Rockwell Automation provides technical information on the Web to assist you in using its products.

At <http://www.rockwellautomation.com/support>, you can find technical manuals, technical and application notes, sample code and links to software service packs, and a MySupport feature that you can customize to make the best use of these tools. You can also visit our Knowledgebase at <http://www.rockwellautomation.com/knowledgebase> for FAQs, technical information, support chat and forums, software updates, and to sign up for product notification updates.

For an additional level of technical phone support for installation, configuration, and troubleshooting, we offer TechConnect<sup>SM</sup> support programs. For more information, contact your local distributor or Rockwell Automation representative, or visit <http://www.rockwellautomation.com/support/>.

## Installation Assistance

If you experience a problem within the first 24 hours of installation, review the information that is contained in this manual. You can contact Customer Support for initial help in getting your product up and running.

United States or Canada	1.440.646.3434
Outside United States or Canada	Use the <a href="http://www.rockwellautomation.com/support/americas/phone_en.html">Worldwide Locator</a> at <a href="http://www.rockwellautomation.com/support/americas/phone_en.html">http://www.rockwellautomation.com/support/americas/phone_en.html</a> , or contact your local Rockwell Automation representative.

## New Product Satisfaction Return

Rockwell Automation tests all of its products to ensure that they are fully operational when shipped from the manufacturing facility. However, if your product is not functioning and needs to be returned, follow these procedures.

United States	Contact your distributor. You must provide a Customer Support case number (call the phone number above to obtain one) to your distributor to complete the return process.
Outside United States	Please contact your local Rockwell Automation representative for the return procedure.

## Documentation Feedback

Your comments will help us serve your documentation needs better. If you have any suggestions on how to improve this document, complete this form, publication [RA-DU002](#), available at <http://www.rockwellautomation.com/literature/>.

**[www.rockwellautomation.com](http://www.rockwellautomation.com)**

### Power, Control and Information Solutions Headquarters

Americas: Rockwell Automation, 1201 South Second Street, Milwaukee, WI 53204-2496 USA, Tel: (1) 414.382.2000, Fax: (1) 414.382.4444  
Europe/Middle East/Africa: Rockwell Automation NV, Pegasus Park, De Kleetlaan 12a, 1831 Diegem, Belgium, Tel: (32) 2 663 0600, Fax: (32) 2 663 0640  
Asia Pacific: Rockwell Automation, Level 14, Core F, Cyberport 3, 100 Cyberport Road, Hong Kong, Tel: (852) 2887 4788, Fax: (852) 2508 1846