

Guardmaster® Safedge™ Pressure Sensitive Safety Edge System Installation and User Manual 440F

Original Instructions in English



Important User Information





Because of the variety of uses for the products described in this publication, those responsible for the application and use of this control equipment must satisfy themselves that all necessary steps have been taken to assure that each application and use meets all performance and safety requirements, including any applicable laws, regulations, codes and standards.

The illustrations, charts, sample programs and layout examples shown in the guide are intended solely for purposes of example. Since there are many variables and requirements associated with any particular installation, Rockwell Automation does not assume responsibility or liability (to include intellectual property liability) for actual use based upon the examples shown in this publication.

Rockwell Automation publication SGI-1.1, Safety Guidelines for the Application, Installation and Maintenance of Solid-State Control (available from your local Rockwell Automation sales office), describes some important differences between solid-state equipment and electromechanical devices that should be taken into consideration when applying products such as those described in this publication.

Reproduction of the contents of this copyrighted publication, in whole or part, without written permission of Rockwell Automation, is prohibited.

Throughout this manual we use notes to make you aware of safety considerations:

<p>WARNING</p> 	<p>Identifies information about practices or circumstances that can cause an explosion in a hazardous environment, which may lead to personal injury or death, property damage, or economic loss.</p>
<p>IMPORTANT</p>	<p>Identifies information that is critical for successful application and understanding of the product.</p>
<p>ATTENTION</p> 	<p>Identifies information about practices or circumstances that can lead to personal injury or death, property damage, or economic loss. Attentions help you identify a hazard, avoid a hazard, and recognize the consequences.</p>
<p>SHOCK HAZARD</p> 	<p>Labels may be on or inside the equipment (for example, drive or motor) to alert people that dangerous voltage may be present.</p>
<p>BURN HAZARD</p> 	<p>Labels may be on or inside the equipment (for example, drive or motor) to alert people that surfaces may reach dangerous temperatures.</p>

It is recommended that you save this user manual for future use.

Table of Contents

Introduction	4
System Description	4
Storage and Handling	4
Storage.....	4
Handling and Transport	4
Safedge Selection	5
Selection Procedure	5
Safedge Profiles	6
Installation of the Safedge System	9
Installation of "C" Rail	9
Mounting the "C" Rail	9
Assembly and Installation of the Safedge Profile	10
Sensing Surface of Safedge System.....	11
Control Unit Technical Specifications	12
Force Travel Relationship.....	13
Deformation Travels	13
Selecting the Cushion Factor	15
Mounting	15
Terminal Connections	15
Safedge Control Unit: Electrical Connections	16
Control Unit Installation and Wiring	16
Main selector switch	16
Main input terminal	16
24V AC/DC input terminal +ve and -ve	17
Auxiliary Output terminals 31 and 32	17
Safety Output terminals 13, 14, 23 and 24	17
Reset terminal MC-MC	17
Profile connection to control units	17
Connection in Parallel and Series	18
Connecting in Series	18
Alternative Connection Method	18
Connecting in Parallel.....	18
Commissioning and Use Sequence of Operation	18
Manual Reset Mode	18
Automatic Reset Mode.....	19
Comparative Properties.....	19
Applications.....	20
Maintenance and Service	21
Troubleshooting Guide	21
Maintenance	21
Profile Cleaning	21
Routine Maintenance Inspection and Test (recommended weekly or after repair)	21
Thorough Examination and Test (twice yearly or after repair)	21
Repair	22
Record of Routine Inspection and Test (see Maintenance section)	23

Introduction

IMPORTANT

Read this manual in full before installation. After installation, this manual must be retained in a safe and accessible place.

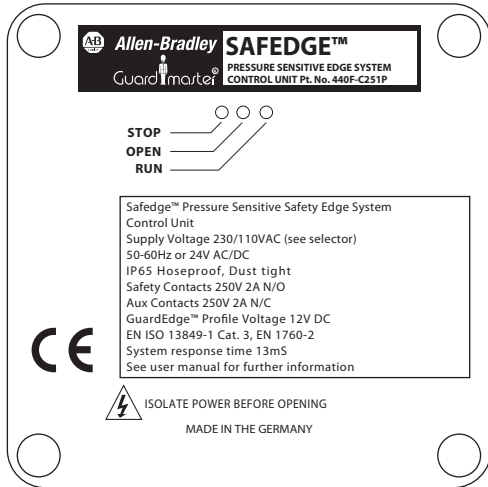

Surface Mounting

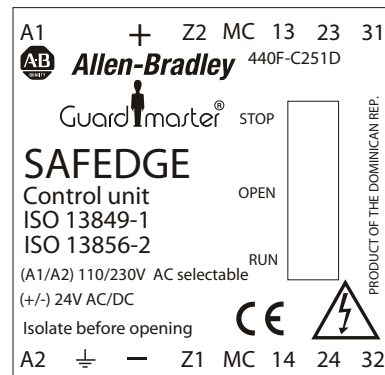

DIN Rail Mounting

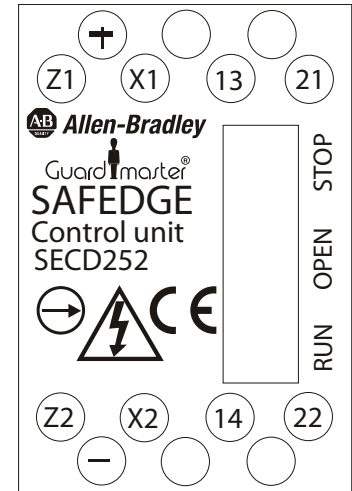

The Safedge sensitive edge sensing system is ideal as a safety sensor in applications such as power operated doors, automated vehicles, moving machinery beds, etc., for use when objects are detected by touch. It can provide a continuous line of high sensitivity touch sensing along or around practically anything.

System Description

The Safedge system consists of up to 50 meters of profile, a cable connector, a terminating resistor, a “C” rail and a control unit. The control unit can monitor lengths of up to 50 meters. All profiles have the same principle of operation.

This manual covers the use of the parts of the Safedge system. If joints or corners are required, contact your supplier. All installation work must be carried out by suitably trained and qualified personnel and should be in accordance with statutory requirements for safety. **READ THIS MANUAL IN FULL BEFORE INSTALLATION.** After installation, this manual should remain in a safe and accessible place. For further assistance, please contact your supplier.

Storage and Handling

Storage

The Safedge control unit and profiles should be stored within the temperature range of -10...55°C (-14...131°F).

Handling and Transport

The Safedge control unit and profile should be transported within the temperature range of -10...55°C (-14...131°F) and should not be subjected to any impact or heavy loads. The original packaging should be used to give protection from excessive flexing. Always unpack carefully and avoid damage resulting from rough handling or the use of knives, box-cutters, etc.

Safedge Selection

The following are the four most important factors influencing the selection of a suitable pressure-sensitive edge or pressure-sensitive bar for a specific application.

- a Category and performance level according to ISO 13849-1 as required for the application.

These are based on:

- the risk assessment for the particular application
- the requirements of a relevant type-C standard.

- b Hazard speed

This is the speed at which the hazardous surface is moving. Normally, one surface is moving and the other is stationary. The maximum possible speed should be considered as the hazard speed. If both surfaces are moving, special consideration is required.

- c Stopping travel of hazardous parts

This is the distance travelled by the hazardous surfaces after a stop signal has been given by the output signal switching device to the machine control system. This travel depends on the hazard speed, the response time of the machine control system and the efficiency of the machine braking system. This travel can be calculated and/or measured. Where appropriate, a suitable safety factor should be used to account for brake deterioration, measurement tolerances, etc.

- d Recovery of the sensor after deformation

On applications where the time between successive actuations of the sensor is less than 30 s. A sensor should be selected which will recover sufficiently for normal operation within the time available.

Selection Procedure

After deciding the category and the performance level according to ISO 13849-1, the procedure is as follows.

- a Determine the required operating speed and maximum hazard speed.

If the maximum hazard speed is not given, it should be measured or calculated. The point in the travel at which the maximum speed occurs will depend on the drive mechanism.

The maximum operating speed of the device should be greater than the maximum hazard speed.

- b Determine the required minimum overtravel distance.

Determine the stopping travel of the hazardous parts. If this is not given, it should be measured and/or calculated. The stopping travel multiplied by a suitable safety factor of at least 1, 2 gives the required minimum overtravel for the application. Where other factors exist, such as a braking system that is subject to deterioration, a higher safety factor should be used.

A simple way to measure the stopping distance is to temporarily fit a position detection at a position close to where the maximum hazard speed occurs. Normally, closed contacts of this position detection should be connected into the machine control stop circuit at the point at which the output signal switching devices would be connected. The machine should be run several times in the worst anticipated conditions and the distance travelled beyond the actuating point of the position detection measured. The maximum distance measured should be regarded as the stopping distance.

- c Determine the maximum permissible force.

When available, the maximum permissible force should be taken from a type-C standard for the specific machine or be in accordance with the risk assessment. The risk assessment should take into account the body parts and types of persons to be protected, for example, children or elderly persons. The speed, shape and material of the sensor and maximum pressure exerted by the device should also be considered. The maximum permissible force should be as low as possible.







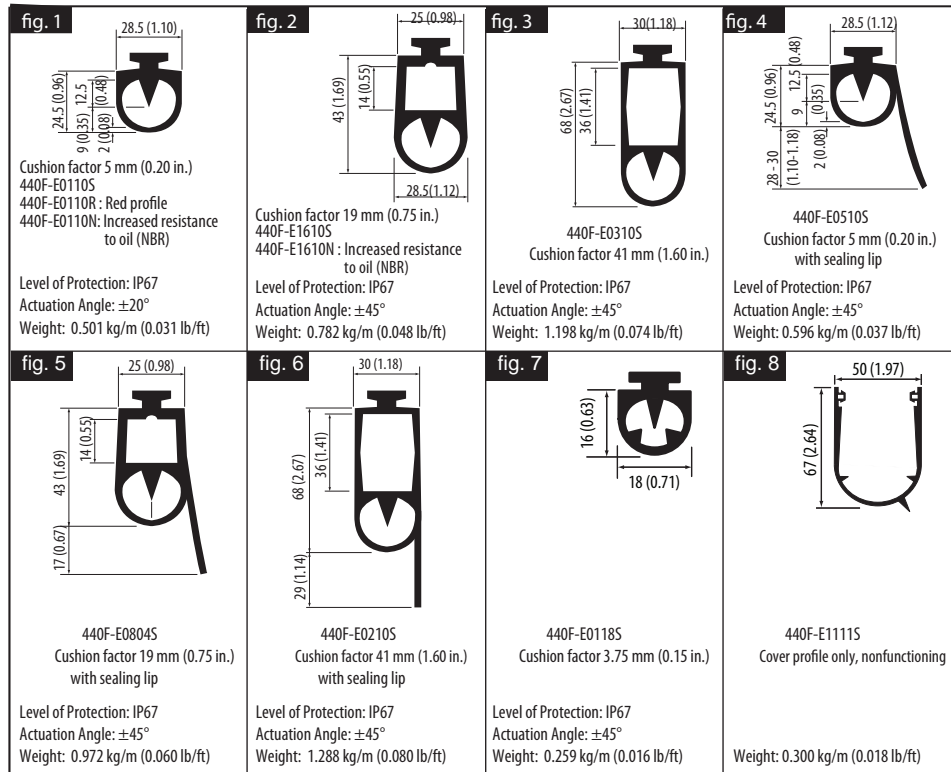

d Select the device.

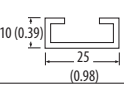
Using the force/distance relationship data or diagrams provided by the manufacturer, select the safeguard with the required maximum operating speed which provides at least the required minimum overtravel distance before the maximum permissible force is reached.

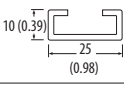
If a pressure-sensitive edge or pressure-sensitive bar with sufficient overtravel cannot be found, it can then be necessary to improve the stopping performance of the machine.

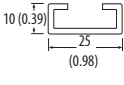
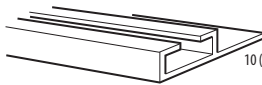
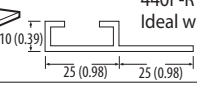
Safedge Profiles [mm (in.)]

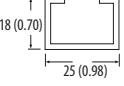

		"C" rail-aluminium C112/A 440F-R1212 Suitable for attaching all the Safedge profiles.
		"C" rail-zinc coated steel C112/S 440F-R1112 Suitable for attaching all the Safedge profiles.
		"C" rail PVC C112/PB = Black 440F-R1212PB C112/PR = Red 440F-R1212PR C112/PY = Yellow 440F-R1212PY Suitable for attaching all the Safedge profiles. Available in 3 colors.
		"C" rail-aluminium C112/A3 440F-R1215 Ideal when external fixing of "C" rail is required. Accepts all profiles.
		"C" rail-aluminium C112/A4 440F-R1216 This deeper rail allows cables to run through channel under Safedge profile. Accepts all profiles.
		"C" rail-aluminium C112/A2 440F-R1214 Ideal when external fixing of "C" rail is required. Accepts all profiles.

A Safedge system consists of the following components: Pressure sensitive profiles, which act as sensors:

Profile Model No.	Profile
440F-EA b c d e	440F-E0110S
440F-EB b c d e	440F-E0110R
440F-EC b c d e	440F-E0110N
440F-ED b c d e	440F-E0510S
440F-EE b c d e	440F-E1610S
440F-EF b c d e	440F-E1610N
440F-GF b c d e	440F-E0804S
440F-EH b c d e	440F-E0310S
440F-EI b c d e	440F-E0210S
440F-EJ b c d e	440F-E0510S
440F-EK b c d e	440F-E0804S
440F-EL b c d e	440F-E0210S
440F-EM b c d e	440F-E0118S
440F-EN b c d e	440F-E1111S
440F-E0 b c d e	440F-E1111S

where:

- b: indicates with or without "c" rail for mounting
- c: indicates location of cable entrance
- d: indicates the termination of the profile and cable length
- e: indicates the length of the profile in mm and is a five digit number

Control units, which evaluate the sensor signal:

Control Unit Model No.	Description
440F-C251P	Enclosure of surface mounting
440F-C251D	Enclosure for DIN rail mounting
440F-C252D	Enclosure for DIN rail mounting

IMPORTANT	PLEASE NOTE THAT ALL "C" RAILS ARE SUPPLIED WITHOUT FIXING HOLES. The "C" Rail 440F-R1212 can be supplied curved to meet most applications.
------------------	--

Each profile uses a combination of non-conductive rubber and a flexible wire-cored conductive rubber, bonded together to form a variety of energy absorbing profiles. The profile has no rigid internal parts which can "break through" or cause fatigue failures after prolonged use. The maximum operating voltage of the profile is 12V DC; operators are therefore not exposed to potentially dangerous voltage should the profile be accidentally cut or sheared. The copper wire core throughout the length of the profile ensures that there is no significant build-up of resistance over long lengths.

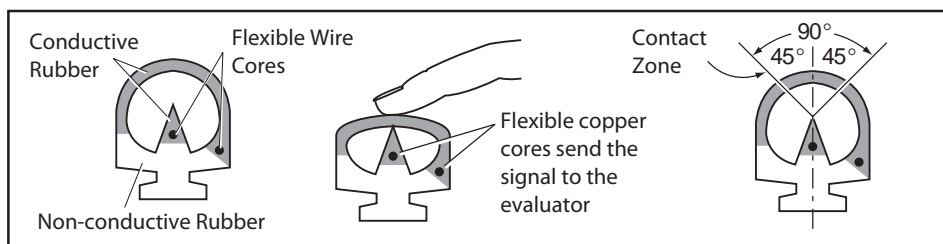

The circuit through the profile is monitored by the Safedge control unit which, in the presence of a 6KΩ resistance (i.e. normal run conditions), produces a signal to the machine control circuit. When the profile is pressed, from any direction through 90° as shown above, the top conductive rubber strip compresses and touches the middle conductive rubber, thus creating a "short circuit" which in turn drops the overall resistance. This is monitored by the control unit that initiates the machine shutdown. Any single fault in the profile or the wiring connections to the profile will be detected; in that case the control unit outputs go to a safe (OFF) state.

Individual profiles connect to each other via wires, axial connectors or standard 90° connectors. Two wires connect the profiles to the control units. The control unit has fully cross-monitored safety relays; it is therefore possible to configure the unit to detect an external contactor fault.

Compliance with the requirements of EN ISO 13856-2:2013 is achieved for the control unit regarding electrical faults and can be met for the associated part of the machine control system. B10d for profile is 10,000.

The Safedge system complies with the requirements of the European EMC Directive. Normal operation under interference conditions likely in industrial environments is assured, as it has been tested and certified.

Faults are excluded per ISO 13849.

- Edges must be installed in an environment that does not cause degradation of profile material.
- Edges must be properly sealed to prevent non-conductive fluids from filling the profile cavity that would prevent pressing the profile.
- Profile must be connected to qualified controller.

IMPORTANT	Special measures may be required in the presence of abnormally high levels of EMI e.g. near welding or induction heating equipment or near radio transmitters or transceivers.
------------------	--



ATTENTION: Because fault exclusion is used Safedge systems can achieve up to PLd Cat. 3. Each application/installation user shall determine required PL level. The system as installed must meet required PL level.

Installation of the Safedge System

ONLY USE 440F-A0020 CYANOACRYLATE.

This type of cyanoacrylate adhesive ensures a lasting sealing and high protection in accordance with the IP65 rating.

Installation of "C" Rail

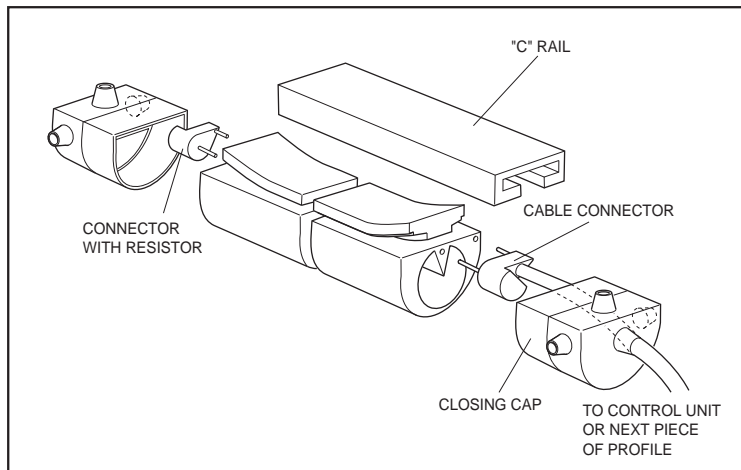

Mounting the "C" Rail

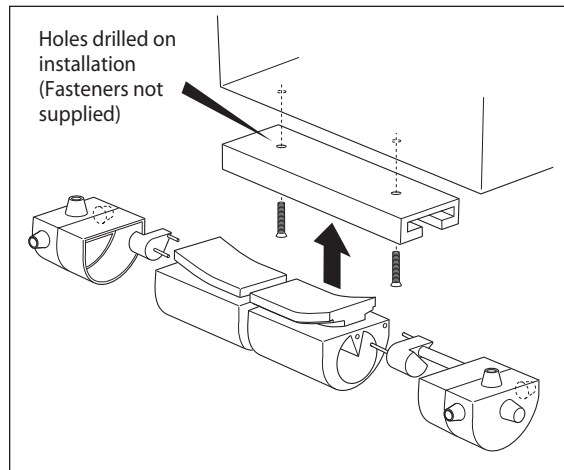

Assembly and Installation of the Safedge Profile

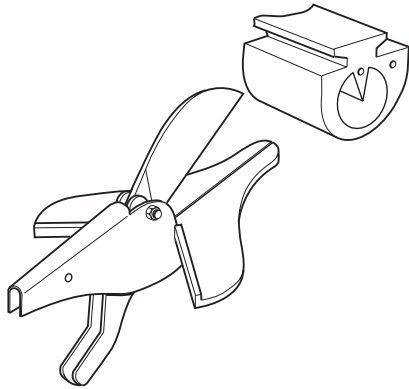

Cut the Safedge profile to length.
Profiles without coasting chamber should be cut with rubber shears.
Profiles with coasting chamber should be cut with a fine tooth saw.

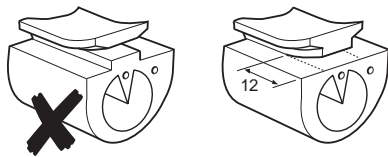

When using the 440F-A1302 closing cap with sealing lip, the profile base must be cut back to a length of 12 mm (0.46 in.). The cut must be precisely made to ensure that the profile base is completely trimmed off, leaving a flush surface.

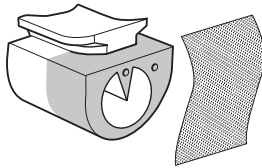

The shaded areas must be roughened with emery/sand paper.

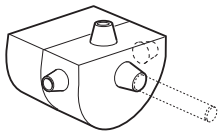

The closing caps are molded with four grommets, each with a rubber plug.
When fitting a resistor, leave the plugs intact. When making a cable connection, select the appropriate cable exit, and remove the plug from the grommet with a hole punch.

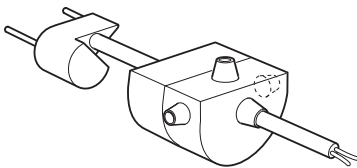

Pull the connecting cable through the hole.

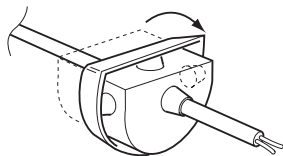

Pierce each of the copper wires with one of the needles. Press the needle contacts of the connector in the direction shown: wedge outwards, straight into the copper wires.

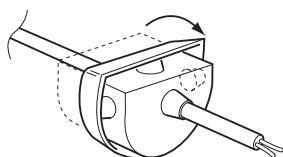

WARNING: The narrow side (wedge) of the connector must show outwards.

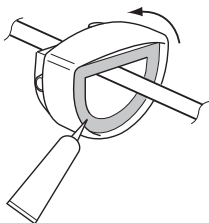

Fold back the sealing lip of the cap, then:

- a Apply adhesive to shaded area of closing cap as illustrated, then affix to edge of profile, applying pressure for ten seconds to ensure adhesion;
- b Apply adhesive to remainder of shaded area and allow sealing lip to make contact with profile.

IMPORTANT

Spread the adhesive evenly over the shaded area! Ensure that no adhesive enters the profile.

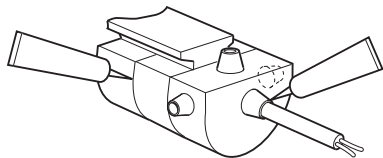

To ensure complete seal, apply more adhesive to the Safedge profile, especially around the grommet/cable exit and sealing lip of the closing cap.

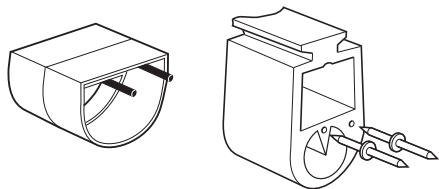

The axial profile connector 440F-A0061S is used for extensions and repairs (see steps above) for the 440F-E0110 series of profiles only. For other types, use straight pin connectors.

When inserting the profile into the “C” rail, a lubricant may be used to reduce friction. When installing, do not pull on connecting cable or on rubber profile.

Sensing Surface of Safedge System

The sensing surface of the Safedge system is active along almost the full length of the edge. The 10 mm at the beginning and end are not active.

Control Unit: Technical Specifications

	440F-C251P Surface Mount	440F-C251D DIN Rail	440F-C252D DIN Rail
Conformity	EN 13849 Pld, Cat. 3, EN ISO 13856-2: 2013		
System response time	13 mS		
Environmental protection	IP65	Enclosure IP40 DIN0470 Terminals IP20 DIN0470	Enclosure IP40 DIN0470 Terminals IP20 DIN0470
Max. Safedge profile voltage	12V DC (open circuit)		
Nominal operating voltage	4V (run condition)		
Max. output fuse	2 A quick acting		5 A quick acting
Impulse withstand voltage	2500V		
Over voltage	Category 2		
Contamination level	III		
Min. switched current/voltage	10 mA/10V		
Power consumption	<6 VA		
Relay outputs	2 x independent volt free N.O. safety contacts 1 x volt free N.C. auxiliary contact NOTE: Auxiliary should not be used for safety.		1 x independent volt free N.O. safety contacts 1 x volt free N.C. auxiliary contact NOTE: Auxiliary should not be used for safety.
Utilization category	AC - 15; 2A / 250V DC DC - 13; 2A / 30V DC		
Safety inputs	Safedge profile (open resistance 6 KΩ)		
Indication LED 1	Green: RUN		
LED 2	Yellow: OPEN		
LED 3	Red: STOP		
Internal controls	AC voltage selector		
Internal fuses	2 A safety fuses, replaceable (2 off); 500 mAT supply fuse, replaceable (1 off)	500 mAT supply fuse, (reset ability) (1 off)	
Max. output fuse	N/A		4 A on AC/2 A on DC
Ambient temp. range—control unit	-10...55°C (-14...131°F)		
Ambient temp. ranges—profile	-5...55°C (23...131°F) EPDM (Ethylene Propylene Diene Modified Rubber) excluding 110N & 01610N: 0...55°C (32...131°F) NBR/CR (Acrylonitrile (34% nitrile) Butadiene Rubber/Chloroprene Rubber)		
Humidity	Up to 90% RH at + 55°C (131°F).		
Vibration	Tested in accordance with IEC 68-2-6, frequency range 10...55 Hz, displacement 0.15 mm, 10 cycles per axis, sweep rate 1 octave per minute		
MC-MC contactor monitor loop	N/C (normally-closed) contactor loop		
Max. conductor size	1 x 1 sq. mm (0.001 sq in.) stranded with sleeves stripped 5 mm (0.2 in.), 1 x 1.5 sq. mm (0.002 sq in.) solid conductor		1 x 2.5 sq. mm (0.004 sq in.) stranded with sleeves stripped 8 mm (0.31 in.), 1 x 4 sq. mm (0.006 sq in.) solid conductor
Terminals	Minus terminal screws M2 spring action		Plus-minus terminal screws M3.5 with self lifting connection, washer terminal boards separately removable
Installation group	C in accordance with VDE 0110.		
Material—control unit	Polycarbonate		
Mounting details	4 x M4 holes	45 mm DIN rail	22.5 mm DIN rail
Housing	D=75 mm, H=130 mm, W=130 mm (respectively: 2.95 x 5.12 x 5.12 in.)		D=120 mm, H=73 mm, W= 45.5mm (respectively: 4.72 x 2.87 x 1.79 in.), 16 way
Weight	650 g (22.9 oz avdp)		450 g (14.1 oz avdp)
Miscellaneous	The Safedge profile must be terminated with a 6 KΩ resistor.		
Bend radius, minimum	500 mm (19.8 in.)		

	440F-E0110N	440F-E0510S 440F-E0110R 440F-E0110S	440F-E0210S 440F-E0310S	440F-E1610N 440F-E0118S	440F-E0804S 440F-E1610S
Actuating distance	6.4 mm (0.25 in.)	6.6 mm (0.26 in.)	8.0 mm (0.31 in.)	7.8 mm (0.30 in.)	9.4 mm (0.37 in.)
Response distance	1.2 mm (0.05 in.)	1.9 mm (0.07 in.)	27.2 mm (1.07 in.)	8.4 mm (0.33 in.)	5.0 mm (0.20 in.)

440F-E1111S is a cover profile only and is nonfunctioning.

- max. speed: 100 mm/s
- suitable for the detection of fingers

The control unit must not be mounted inside the hazard zone. Access to the control unit is required for manual reset or for routine indicator observation, so it must be visible when in operation. The control unit can be mounted on either side of the power doors, as long as the only hazard is the actual doors. In all other cases, the control unit can be mounted anywhere convenient outside the hazard zone, taking into account the access requirements for test and maintenance.

Force Travel Relationship

Since the Safedge system is a contact device, a force is required to operate the device. This force is dependent on the shape of the object applying the force, the speed of the object and deformation distance on the profile. To help understand the force requirements, the European standard ISO 13856-2 2013 provides three test objects travelling at two speeds. Shown in the graph below is the force that is applied over the deformation distance on the surface of the profile. Note that the force required to operate the corners is greater than the force required along the straight section of the profile. This force must be used as a guideline, as the inanimate object can not be harmed.

Force vs. Distance

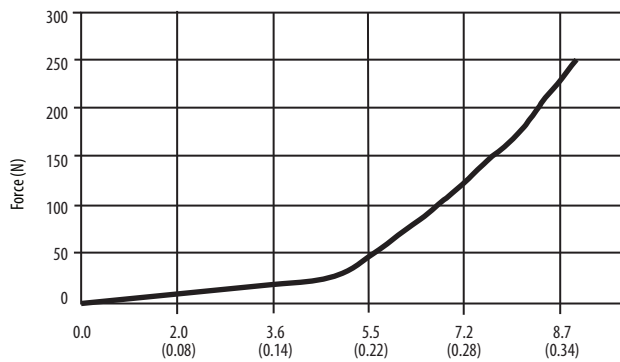

Vp = 10 mm/s

Distance [mm (in.)]

Force vs. Distance

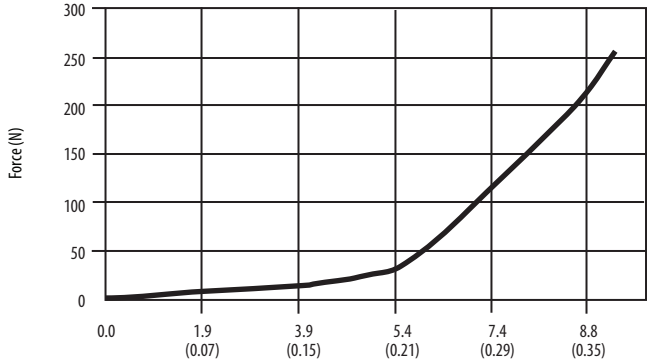

Vp = 100 mm/s

Distance [mm (in.)]

Deformation Travels

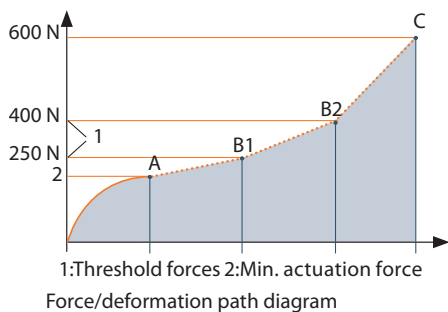

Deformation Travels—440F-E0110N

Test temperature 20°/Speed:	10 mm/s	100 mm/s	200 mm/s
Actuation Force	36.5 N	51.4 N	71.7 N
Response travel A	5.3 mm (0.21 in.)	5.6 mm (0.22 in.)	7.4 mm (0.29 in.)
Total deformations at 250 N B1	9.4 mm (0.37 in.)	8.9 mm (0.35 in.)	10.0 mm (0.39 in.)
Total deformations at 400 N B2	11.4 mm (0.45 in.)	11.0 mm (0.43 in.)	11.8 mm (0.46 in.)
Total deformations at 600 N B2	13.2 mm (0.52 in.)	12.9 mm (0.51 in.)	13.7 mm (0.52 in.)
Compensation travel at 250 N	4.1 mm (0.16 in.)	3.3 mm (0.13 in.)	2.6 mm (0.10 in.)
Compensation travel at 400 N	6.0 mm (0.24 in.)	5.4 mm (0.21 in.)	4.4 mm (0.17 in.)
Maximum stopping distance	5.0 mm (0.20 in.)	4.5 mm (0.18 in.)	3.6 mm (0.14 in.)

Deformation travels—440F-E0110R, 440F-E0110S, 440F-E0510S

Test temperature 20 °C/ Speed	10 mm/s	100 mm/s	200 mm/s
Actuation force	41.7 N	51.1 N	60.6 N
Response travel A	5.7 mm	5.8 mm	4.9 mm
Total deformation at 250 N B1	9.5 mm	8.6 mm	7.6 mm
Total deformation at 400 N B2	11.0 mm	10.6 mm	9.3 mm
Total deformation at 600 N C	13.3 mm	12.6 mm	11.3 mm
Compensation travel at 250 N	3.8 mm	2.8 mm	2.6 mm
Compensation travel at 400 N	5.3 mm	4.7 mm	4.3 mm
Max. stopping distance	4.4 mm	3.9 mm	3.6 mm

Deformation travels—440F-E1610N, 440F-E0118S

Test temperature 20 °C/ Speed	10 mm/s	100 mm/s	200 mm/s
Actuation force	63.6 N	76.9 N	84.6 N
Response travel A	9.7 mm	9.6 mm	9.4 mm
Total deformation at 250 N B1	22.3 mm	19.5 mm	18.5 mm
Total deformation at 400 N B2	28.7 mm	27.6 mm	26.7 mm
Total deformation at 600 N C	31.2 mm	29.9 mm	28.9 mm
Compensation travel at 250 N	12.7 mm	9.9 mm	9.1 mm
Compensation travel at 400 N	19.1 mm	17.9 mm	17.3 mm
Max. stopping distance	15.9 mm	15.0 mm	14.4 mm

Deformation travels—440F-E1610S, 440F-E0804S

Test temperature 20 °C/ Speed	10 mm/s	100 mm/s	200 mm/s
Actuation force	13.5 N	19.5 N	20.6 N
Response travel A	7.3 mm	7.2 mm	6.9 mm
Total deformation at 250 N B1	28.1 mm	25.4 mm	25.4 mm
Total deformation at 400 N B2	32.4 mm	31.1 mm	30.6 mm
Total deformation at 600 N C	34.9 mm	33.8 mm	32.9 mm
Compensation travel at 250 N	20.8 mm	18.2 mm	18.4 mm
Compensation travel at 400 N	25.0 mm	23.9 mm	23.7 mm
Max. stopping distance	20.8 mm	19.9 mm	19.7 mm

Deformation travels—440F-E0310S, 440F-E0210S

Test temperature 20 °C/ Speed	10 mm/s	100 mm/s	200 mm/s
Actuation force	41.6N	68.5 N	87.0 N
Response travel A	6.8 mm	9.6 mm	8.6 mm
Total deformation at 250 N B1	38.1 mm	21.7 mm	22.0 mm
Total deformation at 400 N B2	44.6 mm	44.0 mm	42.5 mm
Total deformation at 600 N C	49.5 mm	49.2 mm	47.6 mm
Compensation travel at 250 N	31.3 mm	12.2 mm	13.4 mm
Compensation travel at 400 N	37.8 mm	34.4 mm	33.9 mm
Max. stopping distance	31.5 mm	28.7 mm	28.3 mm

Selecting the Cushion Factor

One of the important characteristics of edge systems is called cushion factor. The cushion factor is the distance the profile can be depressed after the signal is generated. This is important when the profile is mounted on automated doors.

Automated doors will continue to close for some finite time after the profile sends the initial stop signal. This is known as the system response time. The system response time is the sum of the Safedge control unit response time, the control system response time, and the mechanical stopping time. Systems with longer response time should utilize larger cushion factors. Users must validate that injury does not occur if parts of the body get jammed, for example between the sensing edge and the fixed part of a machine.

Users might also consider a reversing option. When the profile is depressed, the Safedge control unit sends a signal to a reversing relay. Since the reversing relay is not a safety rated device, the user must still confirm that injury does not occur if parts of the body get jammed.

Mounting [mm (in.)]

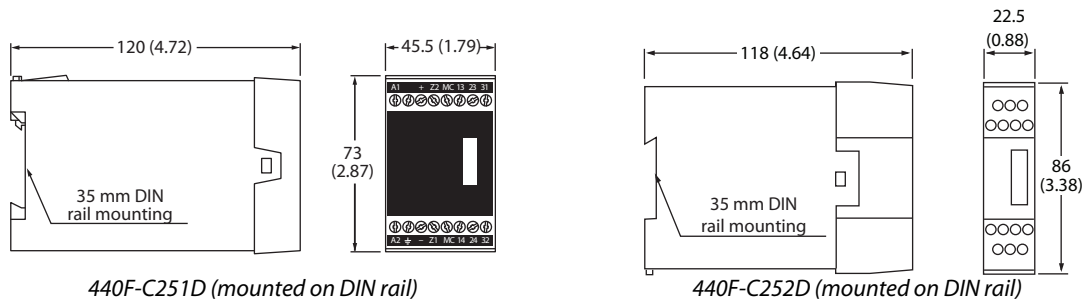
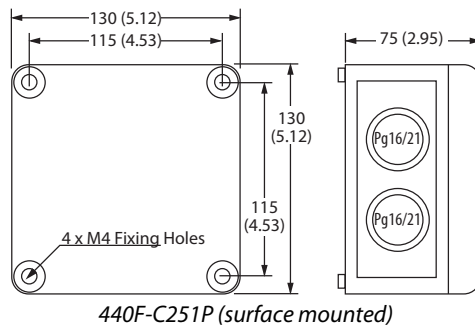

Terminal Connections

To prevent strain on terminal connections, use connection boxes and coiled cables.

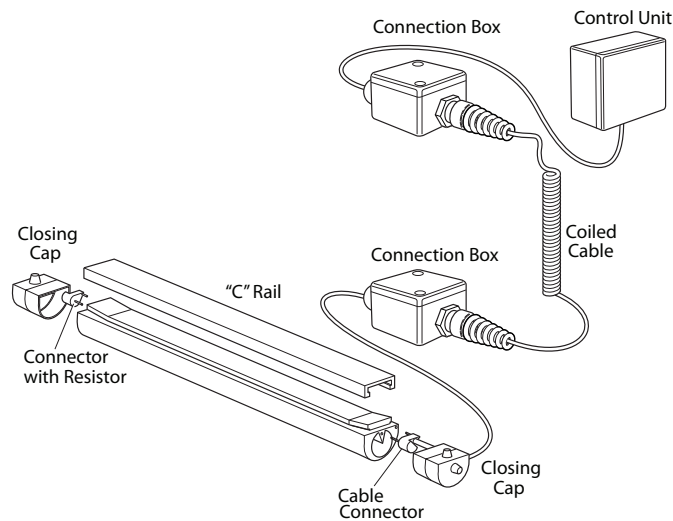

Safedge Control Unit: Electrical Connections

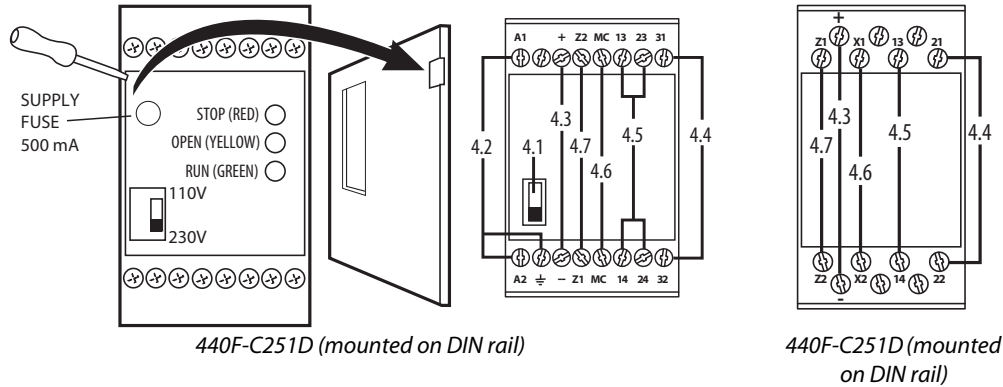
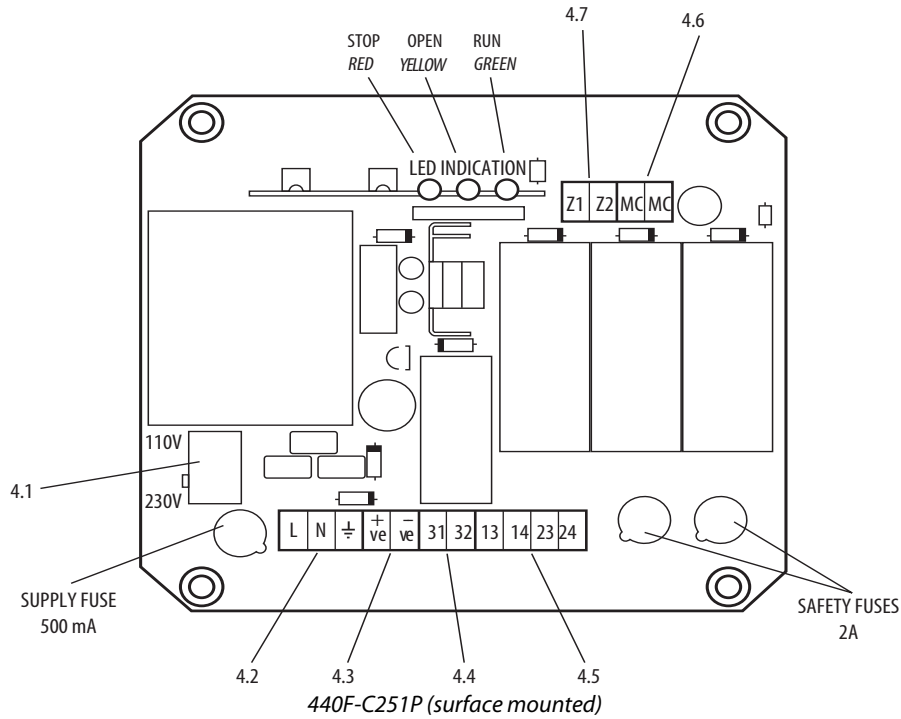

Control Unit Installation and Wiring

IMPORTANT

Wiring must be in accordance with the [British] National Electric Code and applicable local codes and ordinances. Carefully follow the steps listed below for correct installation.

Main selector switch (see 4.1 in drawing above)

If using a 110V AC or a 230V AC supply, set the voltage selector switch accordingly before turning the power on. By default, the factory setting of the unit is 230V AC.

Main input terminal LN PE (A1, A2, PE) (see 4.2 in drawing on page 16)

If using a 110V AC or 230V AC supply, the power supply should be wired, together with a protective earth (ground) to the terminals shown. The size of the protective earth (PE, ground) wire should at least be equal to that of the supply wire. Also check the main selector switch. If these terminals are used, ignore the following paragraph.

24V AC/DC input terminal +ve and -ve or + and - (see 4.3 in drawing on page 16)

If a 24V AC/DC supply is used, the supply should be connected to these terminals, ensuring that the correct polarity is observed. Do not make any connections to the terminals of mains input terminal (above). Where a 24V AC or DC supply is used, it must be isolated from the mains supply in accordance with international electrical safety practice (IEC 364-4-41). One pole should be grounded to the earth. For 24V DC, the negative pole should be grounded. With 24V AC, the ground of the power supply should be connected to the negative terminal.

Aux. Output terminals 31 and 32 or 21 and 22 in 440F-C (see 4.4 in drawing on page 16)

This terminal provides an auxiliary normally-closed contact (i.e. closed when the green RUN light is off) which is suitable for indication or for alarm devices. As this is an auxiliary, it must not be connected to the safety circuit.

Safety Output terminals 13, 14, 23 and 24 (see 4.5 in drawing on page 16)

These are volt-free contacts for connection to the machine safety circuits—in other words, they are connected in series with the machine contactor control circuit (max. rating 2A at 250V AC). Both of these safety circuits are internally fused but must also be externally protected with a 2A quick acting fuse. If you are using only one contactor, terminals 13 and 24 are required and terminals 14 and 23 should be jumpered together. For two contactors with two independent control circuits (i.e. a dual channel system), use 13-14 for one contactor and 23-24 for the other. For two contactors, also see the *Applications* section.

Reset terminal MC-MC or X1 - X2 on the 440F-C2522 (see 4.6 in drawing on page 16)

These terminals are used for a number of different functions (the surface mount version is supplied with jumpers, while the DIN rail version is supplied without a jumper).

Without the jumper, the terminals can be connected to positively guided normally-closed auxiliary contacts on the machine contactors to provide monitoring of the contactors in dual channel control systems. If one contactor fails to isolate the power at de-energization of its control coil, the Safedge system will not allow the other contactor to be energized until the fault has been rectified. Fit a jumper between these terminals on the DIN rail unit if this function is not required.

This terminal is also used for auto/manual reset. If the MC-MC terminal remains jumpered or connected only to the contactor's normally-closed contact, the unit is in automatic reset mode. In automatic reset mode, the output is achieved solely by removal of the actuating force. The output is also achieved at power up of the actuator (when there is no actuation force present). If a spontaneous restart may generate a risk, based on the result of a risk assessment to ISO12100, then this mode must not be used. See IEC60204-1 and EN ISO13849-1.

For manual reset mode, a normally-open spring return (not latching) push button must be connected across the MC-MC terminals or in series with the normally-closed contactors. When the actuating force is removed, the unit will not operate until the button is pressed. The button will also have to be pressed after powering up the control unit.

Profile connection to control units (see 4.7 in drawing on page 16)

These terminals are used to connect the profile to the:

Z1 = Brown (inner conductor).

Z2 = White (outer connector).

Refer to the *Applications* section.

A profile must be terminated with a 6K Ω resistor (yellow) for series connection. If two profiles are connected directly to Z1 and Z2 (in parallel), each profile should be terminated with a 15K resistor (blue).

Connection in Parallel and in Series

Connecting in Series

In installations involving several profiles, they are normally connected in series as shown in the following illustration.

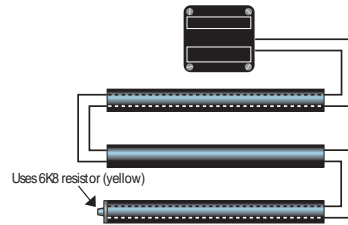

Alternative Connection Method

Connecting in Parallel

A maximum of two profiles can be connected in parallel to facilitate the wiring of certain applications.

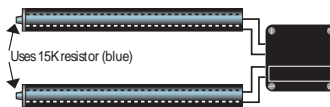

Commissioning and Use Sequence of Operation

When the unit is installed, check the following sequence of operation.

Manual Reset Mode

1. Turn the power on
 - a) Not one LED illuminates.
2. Press the reset switch
 - a) The green RUN LED illuminates.
 - b) Safety contacts close.
 - c) Auxiliary contacts open.
 - d) Contactors energize.
3. Press the profile
 - a) The green RUN LED extinguishes.
 - b) The red STOP LED illuminates.
 - c) Safety contacts open.
 - d) Auxiliary contacts close.
 - e) Contactors de-energize.
4. Release the profile
 - a) The red STOP LED extinguishes.
 - b) System has returned to step 1a.
5. If profile is pressed before reset
 - a) The red STOP LED will illuminate each time the profile is pressed but the safety contacts will not energize.

Automatic Reset Mode

1. Turn the power on
 - a) The green RUN LED illuminates.
 - b) Safety contacts close.
 - c) Auxiliary contacts open.
 - d) Contactors energize.
2. Press the profile
 - a) The green RUN LED extinguishes.
 - b) The red STOP LED illuminates.
 - c) Safety contacts open.
 - d) Auxiliary contacts close.
 - e) Contactors de-energize.
3. Release the profile
 - a) System has returned to step 1a.

IMPORTANT	Terminal block tightening torque rating is 7 in•lbs, suitable for wire sizes 16 AWG. Use 16 AWG minimum. Use copper conductors only. Temperature rating of field wiring shall not be less than ambient.
------------------	--

Comparative Properties

	NBR/CR Profiles 440F-E0110N 440F-E1610N	EPDM Profiles 440F-E0110S 440F-E0110R 440F-E0510S 440F-E1610S 440F-E0804S 440F-E0310S 440F-E0210S 440F-E0118S
Tensile strength (reinforced) mPA	26	20
Resilience (20°C)	F	G
Low temperature flexibility	F	G
Resistance to sunlight	G	G
Resistance to heat ageing	G	G
Resistance to oxidation	F	G
Resistance to ozone	F	G
Resistance to H ₂ O	G	G
Resistance to dilute acids	F	G
Resistance to concentrated acids	F	G
Resistance to oils & greases	G	P

440F-E1111S is a cover profile only and is nonfunctioning.

Key: G= Good, F = Fair, P = Poor

IMPORTANT	Profile must be selected according to intended environment.
------------------	---

Applications

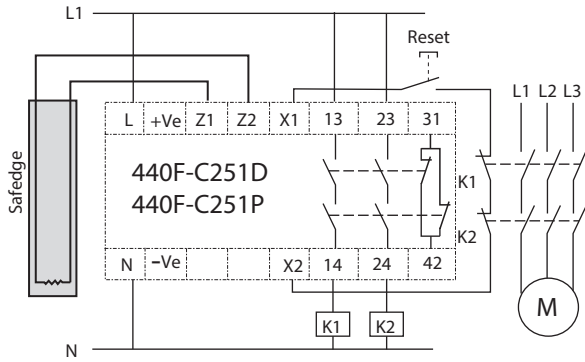

Series Terminated, Safedge Input, Manual Reset, Dual Channel Output, Monitored Output

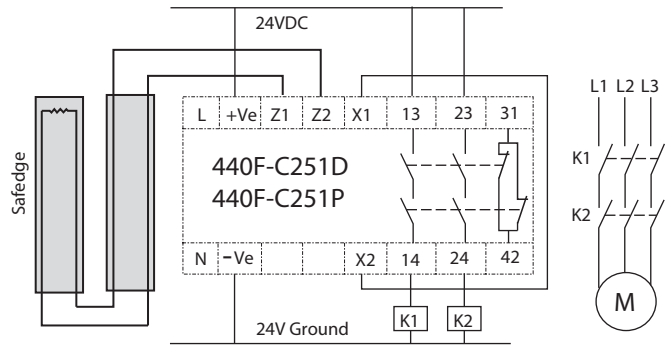

Series Terminated, Cascaded, Safedge Input, Automatic Reset, Dual Channel Output, No Output Monitoring

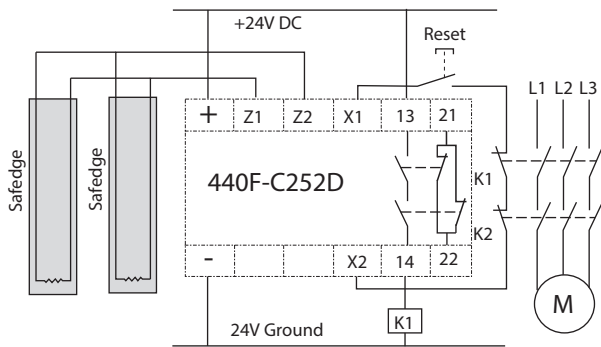

Parallel Terminated, Safedge Input, Manual Reset, Single Channel Output, Monitored Output

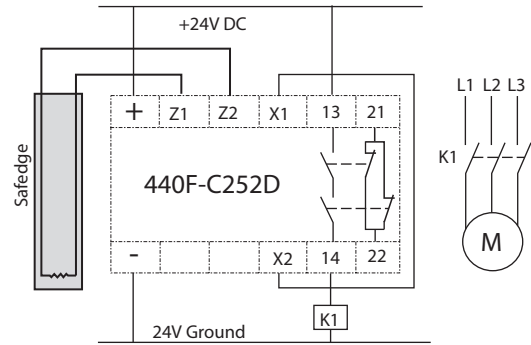

Series Terminated, Safedge Input, Automatic Reset, Single Channel Output, No Output Monitoring

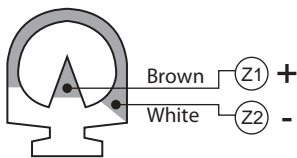

The wiring diagram on the left shows a 110/230V AC application with one contactor (shown here with profile pressed). The right side of the illustration above shows a 110/230V AC application with two contactors, contactor monitoring and START/STOP circuit (also shown profile pressed).

Maintenance and Service

Troubleshooting Guide

Symptom	Probable Cause	Check
The yellow OPEN LED illuminates.	Open circuit in profile or connecting wiring	Ensure Z1-Z2 terminals are secure. Check cable for breaks. Check profile for damage.
Not one LED illuminates even if profile is pressed.	Supply failure.	Make sure that voltage selector switch is set correctly. Check supply fuse. Ensure that supply voltage is present.
Not one LED illuminates unless profile is pressed and then the red STOP LED illuminates.	Failure to reset.	If using contactor monitoring, ensure that each contactor is functioning correctly. Ensure that MC-MC terminals are secure. Check that link is in place and that Reset button functions correctly.
Unit appears to work correctly but there is no output.	Blown fuse. Damaged or incorrect wiring. Fault on Safedge causing the outputs to fail safe	Check output fuses. Inspect all wiring for damage. Check for movement on any internal relays. REPLACE CONTROLLER.
Machine does not stop when profile is pressed. The green RUN LED goes off.	Incorrect external connections	Inspect all wiring to contactors for mistakes.
Machine does not stop when profile is pressed. The green RUN LED stays on.	DO NOT ALLOW THE USE OF THE MACHINE. REPLACE CONTROLLER.	

Maintenance

Carefully read this section, in full, before attempting any maintenance work.

During maintenance operations, disconnect the machine's prime mover before working on the Safedge system. Observe all applicable electrical safety precautions.

Profile Cleaning

The profiles should be kept clean of deposits such as swarf (fine metallic filings or shavings removed by cutting, grinding or any other mechanical process), debris, and other foreign materials to prevent damage or dead-zones. It is permissible to use warm water and a mild detergent to clean the surface area.

Routine Maintenance Inspection and Test — Recommended weekly or after repair

IMPORTANT	DO NOT USE SOLVENTS.
------------------	-----------------------------

Stop the machine, clean the profile or profiles and allow them to dry off. Inspect the surface of the profile for damage. Any damage that punctures the profile could let material or liquid in. It must be dealt with immediately. Check that all end caps, corners and joints are secure and free from damage. Damaged parts must be replaced immediately.

Test the profile operation. Two people may be required, one to press the profile and one to observe the operation of the control unit. On systems using manual reset mode, the reset button must be pressed continuously. Check that the green RUN LED is illuminated when the profile is not pressed and that the red STOP LED is illuminated when it is. Start the machine, press the profile and check that the machine stops immediately.

If these checks reveal any problem, do not allow use of the machine until the problems are rectified. Record all inspections and tests in a written log.

Thorough Examination and Test — Twice yearly or after repair

To be undertaken by a person competent in electrical and mechanical engineering.

- Carry out tests as listed in previous paragraph.
- Isolate the power source to the machine and Safedge system. Observe usual electrical safety precautions.
- Inspect the profile and components thoroughly for mechanical damage.
- Disconnect the wires to the profile at terminals Z1-Z2.
- Connect the wires from the profile to the input of an ohmmeter. One person should now press the profile with one hand at every point on the strip. The resistance should measure $6K\Omega \pm 10\%$ when the profile is not pressed, and no greater than $1K$ when it is.

If these checks reveal any problems, do not allow the use of the machine until they are rectified.

Record the inspection and test in a written log (see typical written log on page 23).

Repair

Prior to working on a Safedge system or machine control system, isolate the power source to the machine and Safedge system. Observe all applicable electrical safety precautions.

User repairs are limited to replacement with new Safedge system parts. In the event of any problems, the units should be returned to the supplier.

Any repairs to the connecting wires should be made using heat shrink butt splice connectors.

After replacing any part of the system, the inspection and test procedures detailed in the last two sections must be carried out with special attention given to those parts replaced.

IMPORTANT

TAMPERING WITH COMPONENT PARTS WILL INVALIDATE WARRANTY. WARRANTY IS INVALID IF QUALITY SEAL IS BROKEN ON THE DIN RAIL (440F-C251D) CONTROL UNIT.

IMPORTANT

After maintenance or repair operations, it is essential that all fastenings, cable protection, etc. be correctly refitted. Failure to do so, or the use of non-approved parts may result in the Safedge system failing to achieve its specified performance.

Rockwell Automation Support

Use the following resources to access support information.

Technical Support Center	Knowledgebase Articles, How-to Videos, FAQs, Chat, User Forums, and Product Notification Updates.	https://rockwellautomation.custhelp.com/
Local Technical Support Phone Numbers	Locate the phone number for your country.	http://www.rockwellautomation.com/global/support/get-support-now.page
Direct Dial Codes	Find the Direct Dial Code for your product. Use the code to route your call directly to a technical support engineer.	http://www.rockwellautomation.com/global/support/direct-dial.page
Literature Library	Installation Instructions, Manuals, Brochures, and Technical Data.	http://www.rockwellautomation.com/global/literature-library/overview.page
Product Compatibility and Download Center (PCDC)	Get help determining how products interact, check features and capabilities, and find associated firmware.	http://www.rockwellautomation.com/global/support/pcdc.page

Documentation Feedback

Your comments will help us serve your documentation needs better. If you have any suggestions on how to improve this document, complete the How Are We Doing? form at http://literature.rockwellautomation.com/idc/groups/literature/documents/du/ra-du002_-en-e.pdf.

Rockwell Automation maintains current product environmental information on its website at <http://www.rockwellautomation.com/rockwellautomation/about-us/sustainability-ethics/product-environmental-compliance.page>.

Allen-Bradley, Rockwell Automation, and Rockwell Software are trademarks of Rockwell Automation, Inc.
Trademarks not belonging to Rockwell Automation are property of their respective companies.

Rockwell Otomasyon Ticaret A.Ş., Kar Plaza İş Merkezi E Blok Kat:6 34752 İçerenköy, İstanbul, Tel: +90 (216) 5698400

www.rockwellautomation.com

Power, Control and Information Solutions Headquarters

Americas: Rockwell Automation, 1201 South Second Street, Milwaukee, WI 53204-2496 USA, Tel: (1) 414.382.2000, Fax: (1) 414.382.4444
Europe/Middle East/Africa: Rockwell Automation NV, Pegasus Park, De Kleetlaan 12a, 1831 Diegem, Belgium, Tel: (32) 2 663 0600, Fax: (32) 2 663 0640
Asia Pacific: Rockwell Automation, Level 14, Core F, Cyberport 3, 100 Cyberport Road, Hong Kong, Tel: (852) 2887 4788, Fax: (852) 2508 1846

Publication 440F-IN003A-EN-P - February 2015



31611

31611 Ver 03